

37 / 65

P37FT05AUB
P65FT00AUB

USER'S MANUAL

FULL HD DISPLAY

English

AVIAMO™

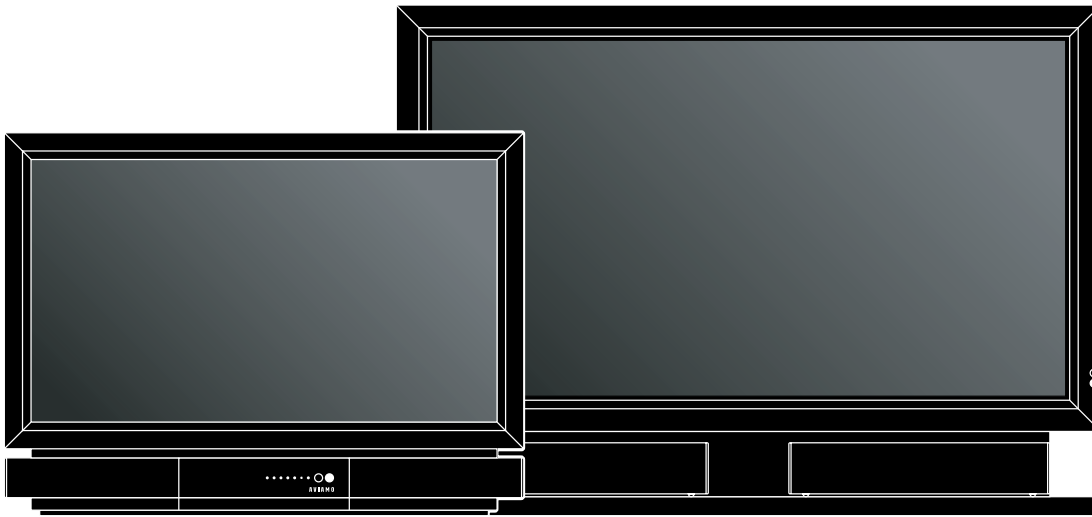

Before using the display, read this manual carefully so that you know how to use the display correctly.

Two manuals of the "Safety Precautions" and this "User's Manual" are supplied with the display. Especially, be sure to read and observe the "Safety Precautions". Refer to this manual whenever questions or problems about operation arise. Keep this manual in the place where the user can see it easily.

** Installation and removal require special expertise. Consult your dealer for details.*

** The last digit of Model No. (10 digit alphanumeric characters) indicated on the product means the body color indication alphabet or the management number.*

AVM III Advanced Video Movement

HDMI
HIGH DEFINITION MULTIMEDIA INTERFACE

DOLBY DIGITAL

TV GUIDE

FUJITSU GENERAL LIMITED

CONTENTS

INFORMATION	3	Gamma	29
ACCESSORIES	4	ALC Setting	29
TRADEMARK INFORMATION	4	Picture Memory	30
INSTALLATION	5	ADJUSTING TO DESIRED AUDIO (AUDIO MENU)	31
TOPPLING PREVENTION	6	Treble	31
ATTACHING THE FERRITE CORES	6	Bass	31
PART NAMES AND FUNCTIONS	7	Balance	31
DISPLAY SECTION – FRONT	7	Loudness	31
DISPLAY SECTION – BACK	8	Sound Mode	31
REMOTE CONTROL	10	ADJUSTING SCREEN POSITION AND SIZE (POSITION/SIZE MENU)	32
USING THE REMOTE CONTROL	12	Position	32
PUTTING BATTERIES IN THE REMOTE CONTROL	12	Size	32
PRECAUTIONS	12	OTHER SETTINGS (FEATURES MENU)	33
EFFECTIVE RANGE FOR THE REMOTE CONTROL	13	ADJUSTMENT ITEMS	33
BASIC CONNECTION AND PREPARATION OF THE SYSTEM	14	Dot Clock	33
CONNECTIONS TO THE DISPLAY	14	Clock Phase	33
TO RECEIVE CABLE TV PROGRAMS (WITH CableCARD)	15	Clamp Position	33
TO RECEIVE CABLE TV PROGRAMS (WITHOUT CableCARD) ...	16	Auto Calibration	33
TO RECEIVE TERRESTRIAL TV PROGRAMS	16	ON SCREEN MENU SETTING	33
CONNECTING TO EXTERNAL EQUIPMENT	17	OSD	33
EXAMPLE OF CONNECTING EXTERNAL EQUIPMENT	18	Language	33
BASIC OPERATIONS	19	Name Select	34
Power ON	19	Input Terminal SETTING	34
Power OFF (standby state)	19	Selecting the settings of D-SUB Input terminal	34
VOL (Volume)	19	Clock Set SETTING	34
MUTE	19	CC (Closed Caption) Service SETTING	34
WATCHING TV, VIDEO, RGB AND IEEE1394 MODE	20	Display	34
TV	20	Digital	35
CH RETURN	20	Auto Lock (Parental Lock) SETTING	36
ANTENNA/CABLE	20	Parental Ctrl By Level	36
VIDEO	20	Parental Ctrl By Ch	37
RGB	20	New Password	37
Link 1394 (IEEE1394)	20	SETTING OTHERS	38
CONVENIENT TV AND VIDEO FUNCTIONS	21	Auto Off-NO SIG.	38
FAVORITE (Favorite channels)	21	Audio Input	38
GUIDE (TV Guide On Screen)	21	Digital Audio Format	38
CC (Closed Caption)	21	Screen Orbiter	38
MTS/STEREO	21	Direct Setting	39
TV-INFO (INFORMATION)	21	Code Setting	39
Listening mode NIGHT	21	White Screen	39
OTHER BASIC OPERATIONS	22	Background	39
DISPLAY	22	Information	39
OFF TIMER	22	INITIALIZATION OF USER ADJUSTMENT VALUE	40
PICTURE MODE	22	TV SETTING (TV MENU)	41
PICTURE MEMORY	22	Channel Setting	41
WIDE	22	Auto Scan	41
SCREEN SIZE	23	Channel Edit	41
ASPECT RATIO	23	Favorite Ch	42
ADJUSTMENT MENU	24	Multi Ch Audio	42
BASIC PROCEDURES OF ADJUSTMENT MENU	25	Audio Language	42
ADJUSTING TO A DESIRED PICTURE (PICTURE MENU)	26	Fact Ch Reset	42
Signal Contrast	26	CableCARD	42
Drive Contrast	26	Emergency Alert	42
Brightness	26	IEEE1394 SETTING (IEEE1394 MENU)	43
Color	26	STANDBY MODE SETTING	43
Tint	26	IEEE1394 CONNECTION AND OPERATION EXAMPLES ...	43
Sharpness	26	PRECAUTIONS RELATED TO CONNECTION OF IEEE1394 DEVICES ...	44
Ambient Sensor	26	INITIALIZING TV GUIDE ON SCREEN™ SYSTEM	45
Picture Mode	26	USING TV GUIDE ON SCREEN™ SYSTEM	47
Precision Setting	27	LISTINGS	50
Black Level	27	SEARCH	52
Detail Gradation	27	SCHEDULE	54
3D NR	27	RECORDINGS	56
CODEC NR	27	SETUP	56
Image Enhance	27	OPTIONS	57
Color Temp.	27	MAIN SUPPORTED SIGNALS	58
User Color Temp.	27	CLEANING	59
Color Tuning	28	MAINTENANCE	60
Progressive Scan	28	SPECIFICATIONS	61

- Receptacle

Make sure that the power cord's grounding wire is grounded.

The display comes with a 3-prong power plug; one prong is connected to the grounding wire. If you have only a 2-hole receptacle, you will need to have it replaced. Contact your dealer for more information.

- Have the display inspected and cleaned by your dealer at regular intervals.
- When the screen size is set to "Normal" and a picture was displayed for a long time, a residual image may be created at the boundary with the part at which an image is not displayed. We recommend that you use a screen size other than "Normal". (See P. E-22)
- High-precision technology has been used in the manufacture of the plasma display panel, in which the effective pixels exceeds 99.99%. However, please be aware, that fewer than 0.01% of the pixels may be missing or remain constantly lit.
- Some models are fitted with a radiator fan to prevent the display's internal temperature from rising during operation. Be careful of the air emitted by the radiator fan, as it may be hot.
- Contact your dealer when causing a bad influence to the display and other audio-visual equipment mutually.
You may need to move your display if it produces degraded pictures or noise due to electromagnetic radiation, or if the infrared remote control does not function properly.
- Pictures may not be displayed properly if you connect a non-standard PC to the RGB input terminal. In this case, contact your dealer for more information.
- The protective circuit, built into the display, automatically turns off the power if the display has a problem. In this case, you will see that the power indicator lamp flashes red or green.
- Do not display the same picture for a long time, because part of the screen may "burn-in" and create a residual image if the same picture is displayed for an extended period of time. To prolong the life of the plasma display, we recommend the use of the "Screen Orbiter" settings. (See P. E-38) When a residual image was created, reduce the residual image by using the "White screen" settings. Note that there may also be cases when it can not be recovered completely. (See P. E-39)

Warning

If the power indicator lamp flashes red or green, this signifies that the display has developed a problem. When this happens, be sure to unplug from the receptacle to prevent fire or electric shock. Then contact your dealer.

- The power plug shall be inserted into the receptacle at the place where you get it easily.

ACCESSORIES

Safety Precautions



This manual



Remote Control



AA Battery (2)



Power Cord

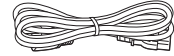

Large ferrite core (5)
(for power cord, S-Video cable,
HDMI cable and RS-232C cable)

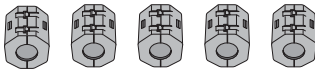

See P. E-6 for the
installation procedure.

Small ferrite core (2)
(for external speaker cable)



See P. E-6 for the
installation procedure.
(for 65" model)

TRADEMARK INFORMATION



Dolby Digital

Manufactured under license from Dolby Laboratories. "Dolby" and the double-D symbol are trademarks of Dolby Laboratories.



HDMI (High-Definition Multimedia Interface)

HDMI, the HDMI logo and High-Definition Multimedia Interface are trademarks or registered trademarks of HDMI licensing LLC.

CableCARD™

CableCARD™ is a trademark of Cable Television Laboratories, Inc.



TV Guide On Screen™

In the United States, TV Guide and other related marks are registered marks of Gemstar-TV Guide International, Inc. and/or one of its affiliates. In Canada, TV Guide is a registered mark of Transcontinental Inc., and is used under license by Gemstar-TV Guide International, Inc.

The TV Guide On Screen system is manufactured under license from Gemstar-TV Guide International, Inc. and/or one of its affiliates.

The TV Guide On Screen system is protected by one or more of the following United States patents 4,908,713; 6,498,895; 6,850,693; 6,396,546; 5,940,073; 6,239,794 to Gemstar-TV Guide International, Inc. and/or its subsidiaries.

Gemstar-TV Guide International Inc. and/or its related affiliates are not in any way liable for the accuracy or availability of the program schedule information or other data in the TV Guide On Screen system and cannot guarantee service availability in your area. In no event shall Gemstar-TV Guide International, Inc. and/or its related affiliates be liable for any damages in connection with the accuracy or availability of the program schedule information or other data in the TV Guide On Screen system.

Note

- Cables for connecting the display to external equipment are not supplied. Contact your dealer for more information on these supporting products.
- The pictures and diagrams in this manual are meant to complement the explanations and may differ slightly from the actual items.

To prevent the display's internal components from overheating, make sure that the display is installed in a well-ventilated location. Be sure to use the optional stand, or the other mounting unit when installing the display. Also, be sure that your dealer performs the installation.

See the appropriate instruction manual for additional information on the mounting hardware you select.

To prevent an accident and ensure safety in the event of an earthquake, fix the display securely into the position as described below.

Use the diagram below to determine how much space is needed to ensure proper heat radiation. This is a minimum space requirement; therefore, provide at least as much space as indicated below.

- * Make sure that the display is installed in a location where the temperature can be maintained between 0°C and 40°C (between 32°F and 104°F)
- * Never attempt to tilt the display sideways or backward.
- * To prevent the power and other cables from being accidentally pulled, make sure that they run along the wall or through corners.
- * To prevent accidents and ensure safety in the event of an earthquake, secure the display to prevent it from tipping over.
- * When placing with the display surface down, lay the body on a flat surface covered with a thick towel, etc. so as not to scratch the display surface. Also be careful that the display does not tip over. Don't place with the back facing down, because there are projections on the back. (For 65" model)

Display Section

	Front	Side
37" model		
65" model		

Note

- For models other than 37" model, speaker is optional.
- See P. E-57 for details on the options.
- The external view is meant to be a representation of the actual unit and is not to scale; therefore, it may differ from the actual shape and size of the product.
- Due to the fragile and highly precise equipment, it is very important to pack properly before transportation using only the packing materials provided.
- Cables for connecting the display to external equipment are not supplied. Contact your dealer for more information on these supporting products.

INSTALLATION (Continued)

TOPPLING PREVENTION

There is the danger of the display being toppled by an earthquake or other unexpected shock. To use the display confidently, take toppling prevention measures.

Install reinforcing hooks (commercial product) at the four threaded holes at the back of the display and secure to a stand or pillar using strong wire (commercial product).

ATTACHING THE FERRITE CORES

- The ferrite cores are used to reduce noise. Attach them correctly as shown in the following illustrations.
- Be sure to turn off power of the display and external equipment before making any connections.
- Carefully check the terminals for position and type before making any connections.
- Loose connectors can result in picture or color problems. Make sure that all connectors are securely inserted into their terminals.

5 large ferrite cores

When connecting the cord to the power input terminal, RS232C terminal, S-video input terminal, and HDMI input terminal (2), attach one of these ferrite cores to the cord and the cable near the terminal.

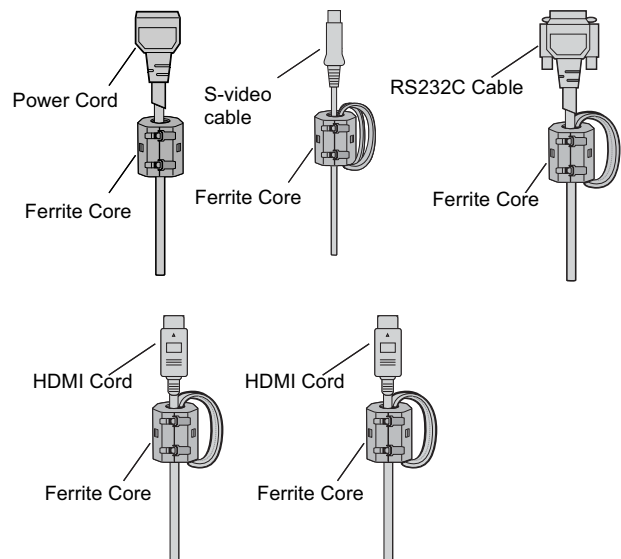

2 small ferrite cores (for 65" model)

When connecting a cable to the external speaker output terminal attach one of these ferrite cores to the cable near the terminal.

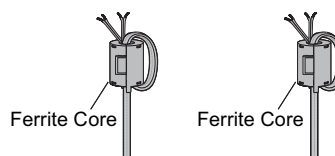

DISPLAY SECTION – FRONT

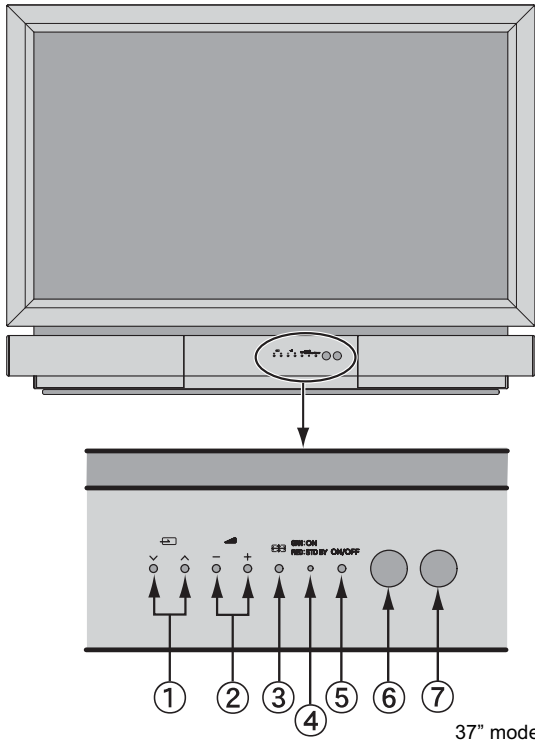

① Input mode selection button

Switches the input modes (Video mode, RGB mode, IEEE1394 mode and TV mode).

② Volume button

Adjusts the sound volume.

③ Wide screen selection button

Switches the screen over to a desired wide screen.

④ Power indicator lamp

This lamp shows the state of the power supply.

Lit (red):	Standby state
Lit (green):	Power ON state
Flashing (red or green):	Malfunction (Flashes differently depending on the type of malfunction.)

⑤ ON/OFF button

Turns the power "ON" and "OFF (standby state)".

⑥ Remote control signal receiver

Receives the signals from the remote control.

⑦ Ambient Sensor

Detects the brightness of ambient light.

It is important not to obstruct it for full functionality of the feature.

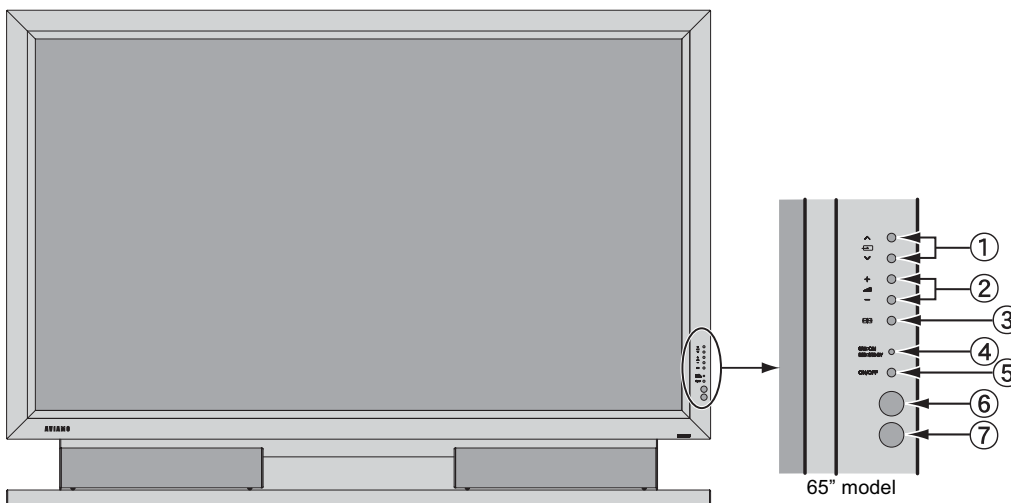

Warning

If the power indicator lamp flashes red or green, this signifies that the display has developed a problem. When this happens, be sure to remove the power plug from the receptacle and contact your dealer. In this circumstance, leaving the display power ON can result in fire or electric shock.

PART NAMES AND FUNCTIONS (Continued)

DISPLAY SECTION – BACK

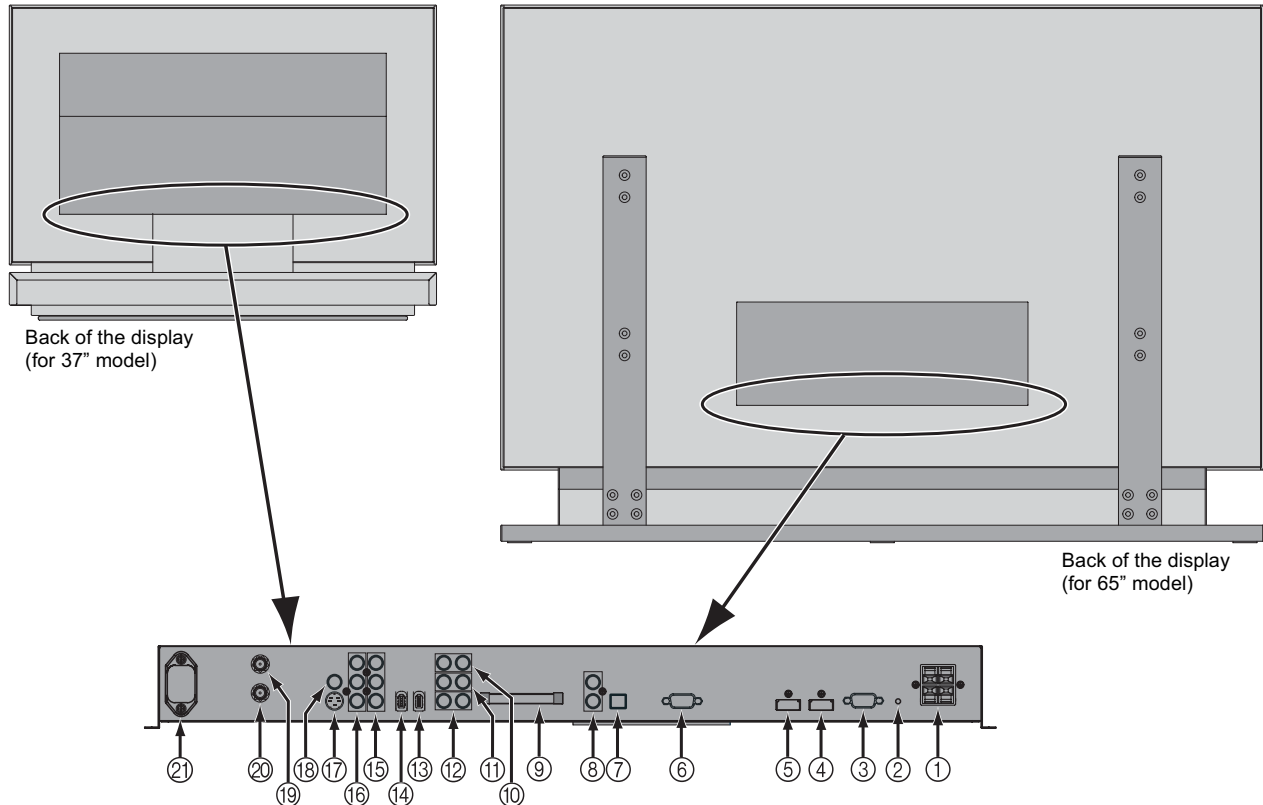

① External speaker output terminal (EXT. SP) for 65" model

Connect these terminals to the speakers.

When connecting a cable, attach a ferrite core to the cable. (See P. E-6.)

* For details, see the speaker unit installation manual.

② Expansion terminal (EXP. PORT)

Currently, this terminal is not functional and is provided to accommodate future technology enhancements. Do not connect any cable to this terminal.

③ RS-232C terminal (RS-232C)

This terminal is provided for you to control the display directly from a PC. Connect it to the RS-232C terminal on the PC.

When connecting a cable, attach a ferrite core to the cable. (See P. E-6.)

④ Video6 input terminal (VIDEO6 INPUT/HDMI)

Connect this terminal to the HDMI output terminal of DVD recorder/player or other video source.

When connecting a cable, attach a ferrite core to the cable. (See P. E-6.)

⑤ Video5 input terminal (VIDEO5 INPUT/HDMI)

Connect this terminal to the HDMI output terminal of DVD recorder/player or other video source.

When connecting a cable, attach a ferrite core to the cable. (See P. E-6.)

⑥ RGB1 input terminal (RGB1 INPUT/mD-sub)

Connect this terminal to the output terminal of a PC, set-top box, game, etc.

⑦ Digital audio output terminal (AUDIO OUTPUT DIGITAL)

Connect this terminal to the digital audio input terminal of the audio amplifier.





- ⑧ **Analog audio output terminal (AUDIO OUTPUT ANALOG)**
Connect this terminal to the analog audio input terminal of the audio amplifier.
- ⑨ **CABLE CARD slot (CABLE CARD)**
To receive cable TV programs insert the card supplied from cable TV provider. (See P. E-15.)
- ⑩ **Audio1 input terminal (AUDIO1 INPUT)**
Connect this terminal to the audio output terminal of VCR or PC, etc.
- ⑪ **Audio2 input terminal (AUDIO2 INPUT)**
Connect this terminal to the audio output terminal of VCR or PC, etc.
- ⑫ **Audio3 input terminal (AUDIO3 INPUT)**
Connect this terminal to the audio output terminal of VCR or PC, etc.
- ⑬ **Link1394 terminal (1394)**
Connect this terminal to a STB, DV camera, AVHDD, etc. by IEEE1394 interface.
- ⑭ **Link1394 terminal (1394)**
Connect this terminal to a STB, DV camera, AVHDD, etc. by IEEE1394 interface.
- ⑮ **Video4 input terminal (VIDEO4 INPUT/Y Pb Pr)**
Connect this terminal to the Component Video Output terminal of DVD recorder/player or satellite receiver.
- ⑯ **Video3 input terminal (VIDEO3 INPUT/Y Pb Pr)**
Connect this terminal to the Component Video Output terminal of DVD recorder/player or satellite receiver.
- ⑰ **Video2 input terminal (VIDEO2 INPUT/S-Video)**
Connect this terminal to the S-Video output terminal of VCR or DVD recorder/player.
When connecting a cable, attach a ferrite core to the cable. (See P. E-6.)
- ⑱ **Video1 input terminal (VIDEO1 INPUT/VIDEO)**
Connect this terminal to the Video output terminal of VCR or DVD recorder/player.
- ⑲ **VHF/UHF antenna input terminal (ANTENNA)**
Connect this terminal to the VHF/UHF antenna signal.
- ⑳ **Cable TV antenna input terminal (CABLE)**
Connect this terminal to the cable TV antenna signal.
- ㉑ **Power input terminal**
Connect this terminal to the power cord supplied with the display.
When connecting a cable, attach a ferrite core to the cable. (See P. E-6.)

PART NAMES AND FUNCTIONS (Continued)

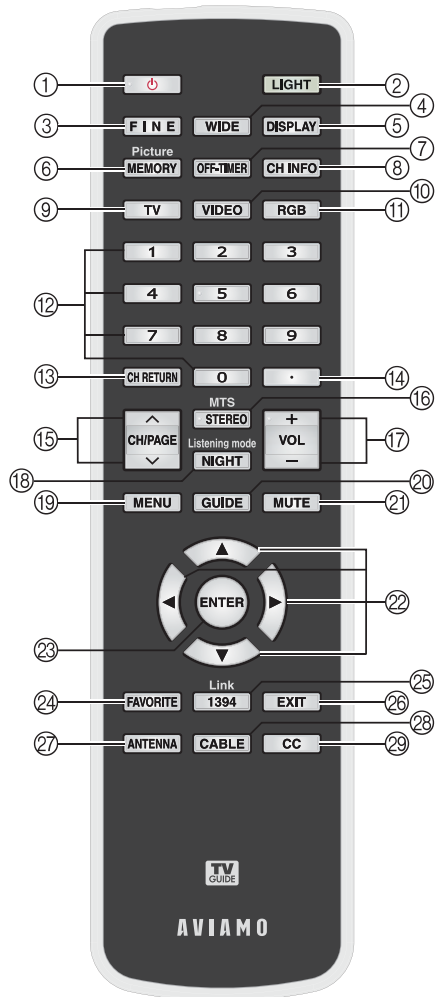
REMOTE CONTROL

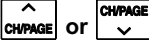





For details, see page →.



- ①  (POWER button) → E-19
Press to switch between Power On and Standby.
- ② **LIGHT** (LIGHT button)
Press to light the buttons of the remote control.
When no operation is performed, lighting of the buttons goes off after 8 seconds.
- ③ **FINE** (FINE mode button) → E-22
Press to switch the Picture Mode.
- ④ **WIDE** (WIDE button) → E-22
Press to switch to a desired wide screen.
- ⑤ **DISPLAY** (DISPLAY button) → E-22
Press to display the channel, input mode, and screen size status.
The status is displayed for about five seconds.
- ⑥ **Picture MEMORY** (PICTURE MEMORY button) → E-22, E-30
Press to recall the Picture Memory.
- ⑦ **OFF-TIMER** (OFF-TIMER button) → E-22
Press to specify the length of time until the power automatically turns off (stand-by state).
- ⑧ **CH INFO** (INFORMATION button) → E-21
Press to display the current channel information.
- ⑨ **TV** (TV button) → E-20
Press to watch TV broadcasting.
- ⑩ **VIDEO** (VIDEO button) → E-20
Press to switch from VIDEO1 through VIDEO6.
- ⑪ **RGB** (RGB button) → E-20
Press to select RGB1.
- ⑫ **0** ~ **9**, **.** (Number buttons) → E-20
Press to directly select a channel.
- ⑬ **CH RETURN** (CHANNEL RETURN button) → E-20
Press to return to the previous channel, Video mode, or RGB mode.
- ⑮  or  (Channel Up/Down buttons) → E-20
Press to select the preset programs.
- ⑯ **MTS**
 (MTS/STEREO button) → E-21
Press to select the audio mode such as MTS (Multi-channel TV Sound) or stereo.
- ⑰  or  (VOLUME buttons) → E-19
Press to adjust the volume control.

Note

- When the buttons are lighted by pressing **LIGHT**, the battery life is shortened.

- Listening mode**
- ⑱ **NIGHT** (NIGHT mode button) → E-21
When viewing at night, lowers the volume to an easy-listening value.
- ⑲ **MENU** (MENU button) → E-24–E-56
Press to display or hide the menu screen.
Use for Picture or Audio adjustment.
- ⑳ **GUIDE** (GUIDE button) → E-21, E-45–E-56
Displays and hides the TV Guide On Screen.
- ㉑ **MUTE** (MUTE button) → E-19
Press to temporarily mute the audio. To restore the sound, press the button again.
Instead, the  or  button can also be pressed.
- ㉒ , , , or  (Adjustment buttons) → E-24–E-56
Use these buttons to select the item or adjust the value of the on screen menu.
- ㉓  (ENTER button) → E-24–E-56
Press to confirm the setting you made with the Adjustment buttons.
- ㉔ **FAVORITE** (FAVORITE button) → E-21
Displays your favorite channel.
- Link**
- ㉕ **1394** (Link1394 button) → E-20, E-43–E-44
Selects and controls the devices connected by IEEE1394 interface.
- ㉖ **EXIT** (EXIT button) → E-25, E-40
Use to exit from a menu screen.
- ㉗ **ANTENNA** (ANTENNA button) → E-20
Press to switch to the signal input of ANTENNA terminal.
- ㉘ **CABLE** (CABLE button) → E-20
Press to switch to the signal input of CABLE terminal.
- ㉙ **CC** (CLOSED CAPTION button) → E-21
Press to display the closed captions.

USING THE REMOTE CONTROL

PUTTING BATTERIES IN THE REMOTE CONTROL

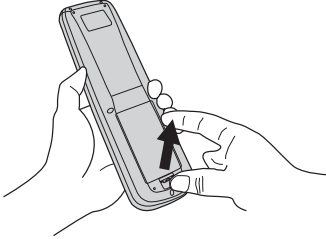

(1) To remove the cover, slide it outwards while pressing it down.

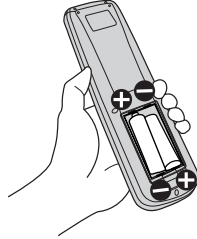

(2) Place two AA batteries in the remote control. Make sure that the batteries are properly oriented.

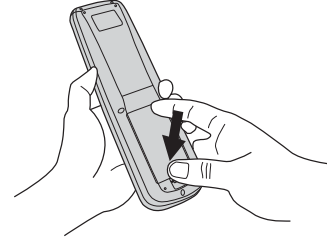

(3) Close the cover until it snaps into place.

PRECAUTIONS

- To prevent malfunction, do not apply any form of severe shock to the remote control.
- To prevent malfunction or deformation, do not allow the remote control to become wet and keep it away from hot surfaces or heating equipment.
- Do not clean the remote control using a cloth dampened in a volatile solvent, such as benzene or thinner.

CAUTION

It is very important to use replacement batteries of the same type as the originally used. Do not use rechargeable batteries (Ni-Cd, etc.).
When disposing of used batteries, please comply with governmental regulations or environmental public institution's rules that apply in your country/area.

EFFECTIVE RANGE FOR THE REMOTE CONTROL

When using the remote control, be sure to point it directly at the display's signal receiver.
Make sure that there are no obstacles between the remote control and the display's signal receiver.

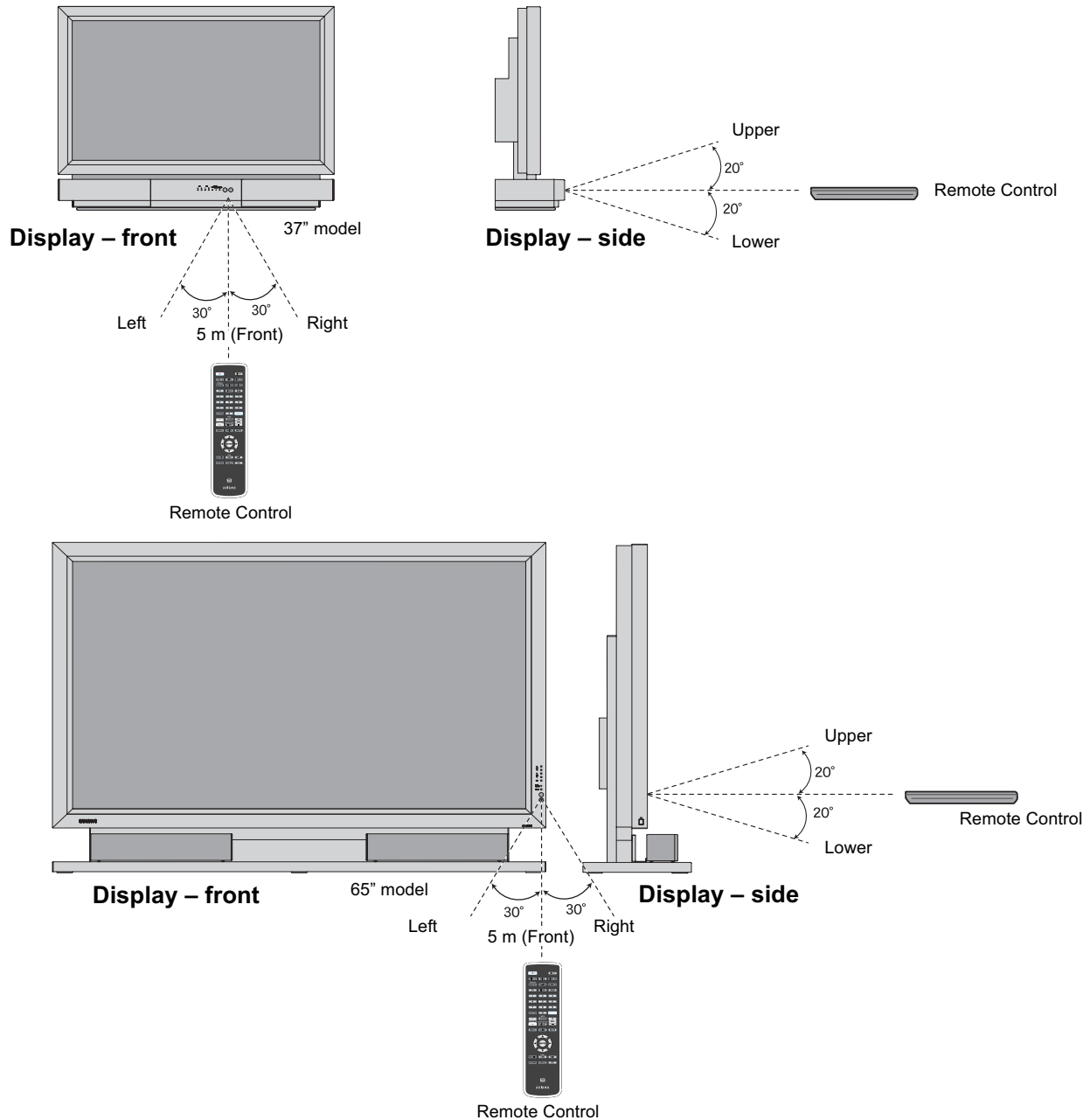

Note

- The remote control will not function properly if the batteries are dead. Be sure to replace them as needed.
- The remote control may not function properly if a high-frequency fluorescent lamp or the like is used. In this case, move the lamp or use the remote control from a different position.

BASIC CONNECTION AND PREPARATION OF THE SYSTEM

- Before this display can be operated for the first time, the connections and settings below must be completed.

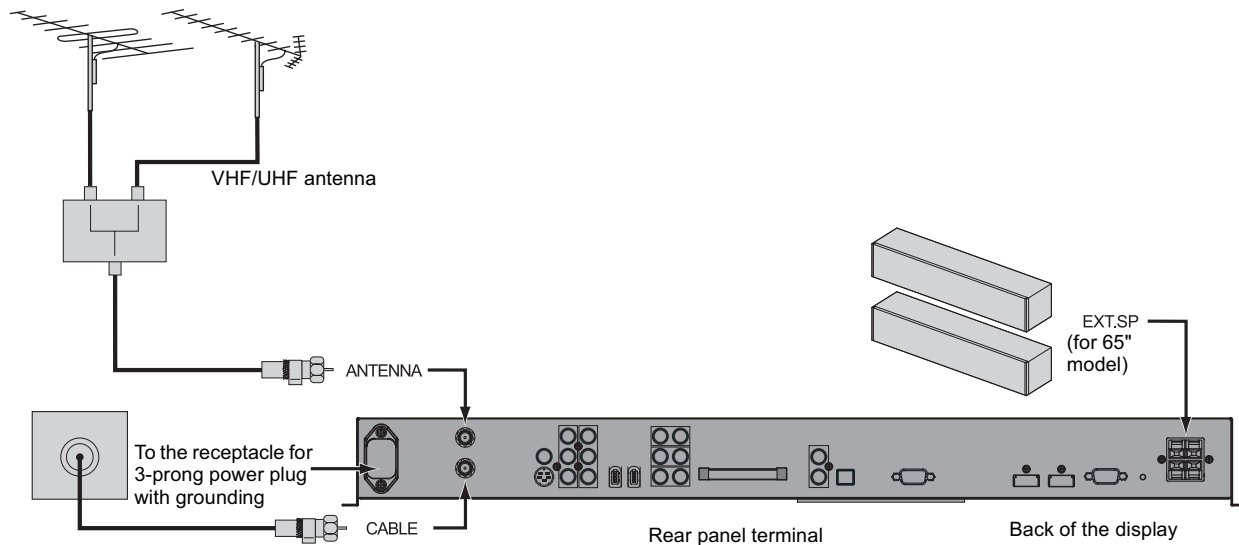

- * For best reception (of terrestrial signal), an outdoor antenna (OTA) is recommended.

CONNECTIONS TO THE DISPLAY

1. **Connect a terrestrial antenna (VHF/UHF) to ANTENNA. (Connect the antenna by referring to the figure above.)**

* When a terrestrial antenna is not connected, proceed as described below.

2. **Connect the cable TV cable to CABLE.**

Connect the cable by referring to the figure above.

3. **Connect the speakers. (For details, see the manual of optional Speaker Unit. for 65\" model)**

4. **Connect external equipment such as a DVD Player. (For details, see "EXAMPLE OF CONNECTING EXTERNAL EQUIPMENT" P. E-18.)**

- The subsequent steps of the setting procedure are different between cable TV programs and terrestrial TV programs.

TO RECEIVE CABLE TV PROGRAMS (WITH CableCARD)

* To watch cable TV broadcasts, sign up with a cable-TV provider before installing and connecting the display. For details, contact the cable-TV provider.

5. Insert the CableCARD.

The cable-TV provider supplies the CableCARD after you sign up for service. (Make sure the cable company knows you are requesting or upgrading to CableCARD service.)

Insert the CableCARD into the slot shown in the figure below before turning on the power for the first time after the purchase of the display.

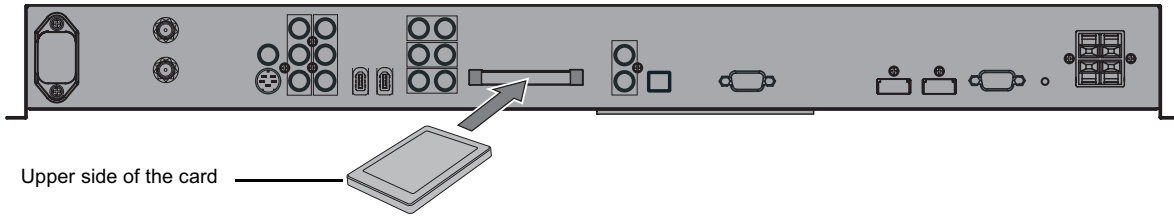

* Be sure to insert the CableCARD designated by the cable-TV provider.

6. Connect the power cord coming from the display to the outlet, and turn on the power supply. For further information, observe the content of "Power On" (P. E-19) .

7. Press **TV** to select the TV mode.

8. Press **CABLE** to select signal of CABLE.

9. Select a desired program.

10. Press **GUIDE** to initialize TV Guide On Screen system.

(For details, see "INITIALIZING TV GUIDE ON SCREEN SYSTEM" P. E-45.)

About CableCARD

- The display enables you to watch cable TV broadcasts without the set top box.
- To watch cable TV broadcasts, you need to sign up with a cable-TV provider in your region.
- The cable-TV provider supplies the CableCARD in response to the contract. You can watch cable TV broadcasts by inserting the CableCARD into the CABLE CARD slot in the display.

Note

- Be sure to use only the CableCARD supplied by the cable-TV provider. Do not insert PCMCIA card other than CableCARD into the CableCARD slot.
- Slowly push in the designated CableCARD until it is locked.
- Insertion of an undesignated card may damage the CableCARD slot.
- Pictures will not display unless CABLE is connected.
- It may take time to obtain channel information.
- When a CableCARD has been inserted into the display, the set's power consumption increases slightly. - in both the standby state and power on state.
- When the power cable is disconnected or broadcasts cannot be received (antenna was disconnected, etc.) after the cable card was inserted/set, it may be impossible to receive data from the cable TV provider. In this case, it may become impossible to view the contracted programs even if the power is turned on again. When this state occurred, please contact the cable TV provider.
- When upgrading the CableCARD firmware, do not remove the power cable or the CableCARD. The CableCARD may be destroyed. The CableCARD firmware may be upgraded in either the standby state or power on state. For checking during upgrading, check the messages on the screen in the power on state.
- If you are using a CableCARD and the display is not operating properly, try disconnecting and reconnecting the power cable and turning the display power on.
- The CableCARD may be hot; remove with caution.

BASIC CONNECTION AND PREPARATION OF THE SYSTEM (Continued)

TO RECEIVE CABLE TV PROGRAMS (WITHOUT CableCARD)

(Continued from page E-14)

* To watch cable TV broadcasts, sign up with a cable-TV provider before installing and connecting the display. For details, contact the cable-TV provider.

5. Connect the display's power cord to the outlet, and turn on the power. (For details, see "Power ON" (P. E-19).)
6. Press **TV** to select the TV mode.
7. Press **CABLE** to select signal of CABLE.
8. Perform Auto Scan. For details, see "TV SETTING (TV MENU) - Channel Setting - Auto Scan" (P. E-41).
9. Select a desired program.
10. Press **GUIDE** to initialize TV Guide On Screen system.

(For details, see "INITIALIZING TV GUIDE ON SCREEN SYSTEM" P. E-45.)

TO RECEIVE TERRESTRIAL TV PROGRAMS

(Continued from page E-14)

5. Connect the display's power cord to the outlet, and turn on the power. (For details, see "Power ON" (P. E-19).)
6. Press **TV** to select the TV mode.
7. Press **ANTENNA** to select signal of ANTENNA.
8. Perform Auto Scan. For details, see "TV SETTING (TV MENU) - Channel Setting - Auto Scan" (P. E-41).
9. Select a desired program.
10. Press **GUIDE** to initialize TV Guide On Screen system.

(For details, see "INITIALIZING TV GUIDE ON SCREEN SYSTEM" P. E-45.)

CONNECTING TO EXTERNAL EQUIPMENT

- Before external equipment is connected, all the power cables must be unplugged.
- For the terminal names, see P. E-8.
- If the equipment to be connected has an HDMI output terminal and component video output terminal, one or the other of the terminals -not both- should be connected.
- Refer to instruction manual for the equipment to be connected.
- There are three audio inputs (HDMI audio excluded). Set them according to Audio Input on P. E-38.
- To receive cable-TV programs, contact a desired cable-TV provider.

See P. E-44 for "PRECAUTIONS RELATED TO CONNECTION OF IEEE1394 DEVICES".

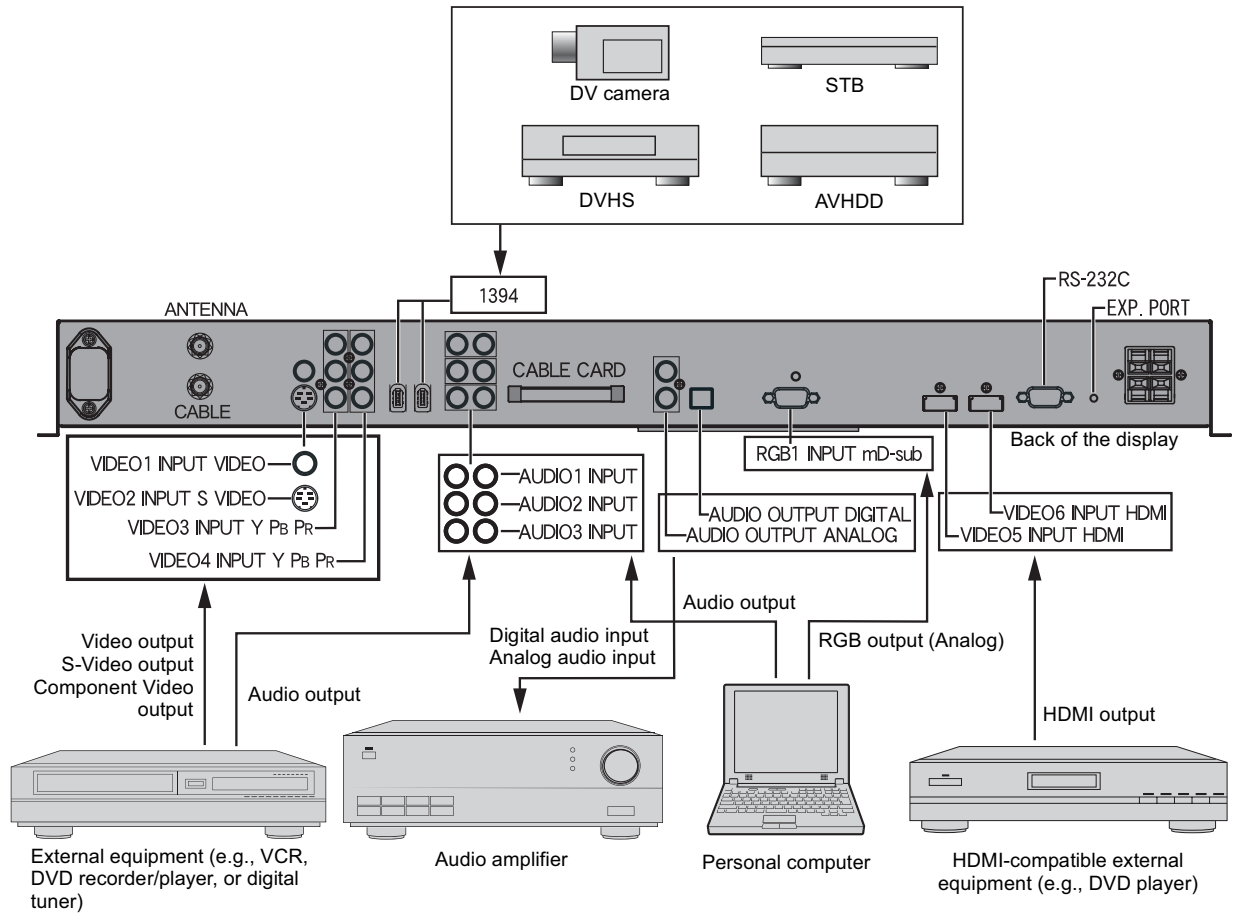

EXAMPLE OF CONNECTING EXTERNAL EQUIPMENT

- Connect the Video signal cable to the HDMI input terminal, Component Video input terminal, S-Video input terminal, or the Video input terminal.
- If the equipment to be connected is equipped with HDMI out put terminal and Component Video output terminal, it is recommended to connect to only one of the terminals. If the HDMI output is connected, an Audio signal cable does not need to be connected.

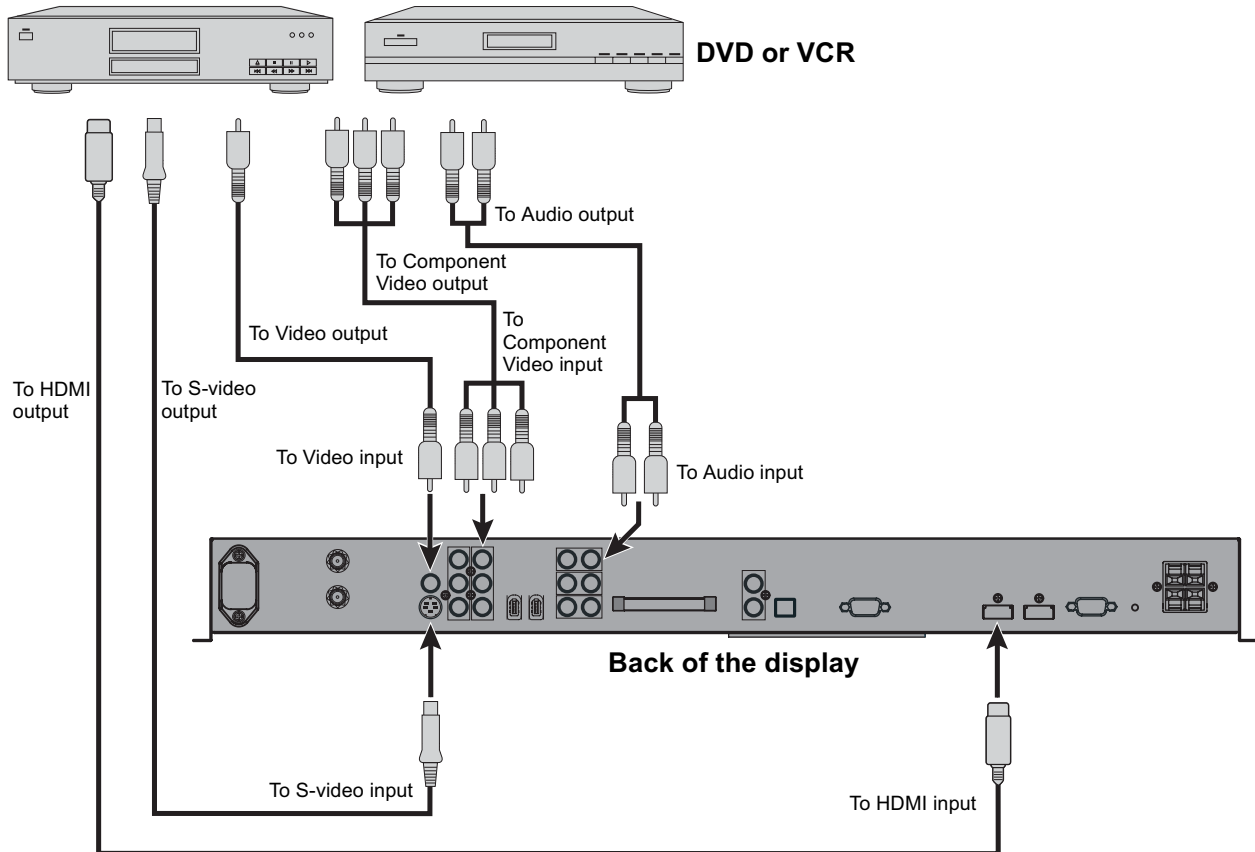

- The table below shows the settings of Audio inputs. (Factory setting)
- * For changing of Audio input settings, see Audio Input on P. E-38.

Video input	Audio input
RGB1(D-sub)	No Audio
Video1(Video)	Audio1
Video2(S-video)	Audio1
Video3(Component Video)	Audio2
Video4(Component Video)	Audio3
Video5(HDMI)	Audio4(HDMI)
Video6(HDMI)	Audio5(HDMI)

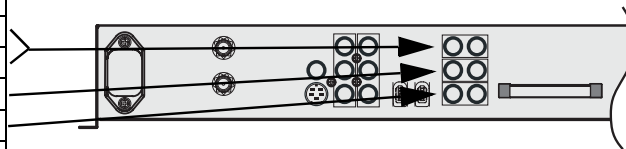

Note

- Unplug the power cord from the AC outlet before you connect external equipment.
- You should also refer to the instructions for the equipment to be connected.

Power ON

Turn "ON" the power.

1 Press .

The power is turned on, and the power lamp changes from "Red" to "Green."

Select the Video, RGB, TV or IEEE1394 mode to enable ordinary operation.

* Make sure that the power cord is connected to a 3-core receptacle in advance. (See P. E-14 of "BASIC CONNECTION AND PREPARATION OF THE SYSTEM")

Power OFF (standby state)

Turn "OFF" the power (the display placed in standby state).

1 Press  when the power is "ON."

The power lamp changes from "Green" to "Red" and the display becomes the standby state.



VOL (Volume)

The volume can be adjusted.

To increase the volume, press .

To decrease the volume, press .



View when  or  is pressed

* Note that the volume level remains stored even when you turn "OFF" the power.

* An audio signal from an audio output terminal (AUDIO OUTPUT DIGITAL or AUDIO OUTPUT ANALOG) does not change.



MUTE

The sound can be temporarily muted.

Press .

The sound is muted.

To restore the original sound volume, press the button again.

The volume can also be restored by pressing  or .

* An audio signal from an audio output terminal (AUDIO OUTPUT DIGITAL or AUDIO OUTPUT ANALOG) does not change.

Note

- If the operation is not executed for about 60 seconds, the menu disappears.
- Some functions may not be available depending on the model or optional equipment.

WATCHING TV, VIDEO, RGB AND IEEE1394 MODE

TV

Select the TV mode to watch TV programs.

1 Press **TV**.

Terrestrial TV programs or cable TV programs are available. The last program No. that you watched is received.

2 Press **ANTENNA** to watch terrestrial programs. Press **CABLE** to watch cable TV programs.

3 Select a desired Program No.

There are two methods to select a Program No.

- Using **1** - **9**, or **.**
- Using **CHPAGE** or **CHPAGE**

* For more information, see P. E-14 "BASIC CONNECTION AND PREPARATION OF THE SYSTEM".

VIDEO

Select the video mode to watch pictures through video inputs.

Press **VIDEO**.

Each time this button is pressed, the video input mode is switched to the next one. The video input mode can also be switched directly by pressing **VIDEO** and then the number button on the remote control.

- VIDEO1: Video
- VIDEO2: S-video
- VIDEO3: Component video
- VIDEO4: Component video
- VIDEO5: HDMI
- VIDEO6: HDMI

* For the settings of input terminals, see "EXAMPLE OF CONNECTING EXTERNAL EQUIPMENT" (P. E-18) and "Audio Input" (P. E-38).

CH RETURN

The program can be toggled back to a previous channel, video input or RGB input.

Press **CH RETURN**.

The program reverts to the channel viewed immediately before the present channel. If the previous content was from another video input, the video mode reverts to that input.

RGB

Select the RGB mode to watch pictures through the RGB input.

Press **RGB**.

The RGB input mode is selected.

* For the settings of input terminals, see "EXAMPLE OF CONNECTING EXTERNAL EQUIPMENT" (P. E-18), "Selecting the settings of D-SUB Input terminal" (P. E-34), and "Audio Input" (P. E-38).

ANTENNA/CABLE

Terrestrial or cable TV broadcastings can be selected.

Press **ANTENNA**.

The ANTENNA signal is selected.

Press **CABLE**.

The CABLE signal is selected.

Link 1394 (IEEE1394)

The connected devices can be controlled from the display. (Control may be impossible, depending on the device.)

Press **Link 1394**.

The devices connected to the 1394 terminals are displayed on the screen.

Select each device, and press **ENTER**.

* For more information, see P. E-43 "IEEE1394 SETTING".

About Auto Lock (Parental Lock)

- Auto Lock is provided for parents to determine that TV programs and video pictures not good for their children are blocked.
- Restrictions on the watching of TV programs can be placed by channel, age, and program category.
- For details, see "Auto Lock (Parental Lock) Setting" on P. E-36.

FAVORITE (Favorite channels)

Favorite channels set by Favorite Ch of the menu can be viewed.

Press **FAVORITE**.

Recalls an already registered channel.

Each time **FAVORITE** is pressed, the set switches to the next registered channel.

* See P. E-42 for how to set "Favorite Ch".

GUIDE (TV Guide On Screen)

Displays TV Guide On Screen.

Press **GUIDE**.

When **GUIDE** is pressed again, the TV Guide On Screen goes off.

* For more information, see "INITIALIZING TV GUIDE ON SCREEN™ SYSTEM" (P. E-45), "USING TV GUIDE ON SCREEN™ SYSTEM" (P. E-47).

* When received the program without TV Guide On Screen system, the information is not displayed in the menu even if the GUIDE key is pressed.

CC (Closed Caption)

Switches closed caption service.

Press **CC**.

Closed caption service is switched as shown below.

- Analog closed caption service

→ Off → CC1 → CC2 → CC3 → CC4 →
TXT1 → TXT2 → TXT3 → TXT4 →

- Digital closed caption service

→ Off → CS1 → CS2 → CS3 → CS4 →
CS5 → CS6 → CC1 → CC2 → CC3 →
CC4 → TXT1 → TXT2 → TXT3 → TXT4 →

* See "CC Service SETTING" (P. E-34) for the setting of digital closed caption service setting.

* To proceed to the next service, press **CC** while the closed caption program name is being displayed.

MTS/STEREO

The audio mode is switched.

Press **MTS/STEREO**.

Each time this button is pressed, the audio mode is switched.

The switching varies depending on the broadcasting contents.

- * The switching method is determined by the program you are watching.
- * The available language is determined by the program you are watching.
- * If a stereo broadcast is hard to hear due to poor reception, change to Mono mode.
- * Monaural sound is presented when SAP mode is selected.

TV-INFO (INFORMATION)

Displays the information (channel No., TV station name, program title, Rating, etc.) for the channel currently being viewed.

Press **CH INFO**.

When **CH INFO** is pressed again, the display goes off.

Listening mode NIGHT

When the NIGHT mode is used when watching TV, even low volume sounds can be heard clearly. This function is convenient when watching TV at night.

Press **Listening mode NIGHT**.

Each time this button is pressed, the setting changes as follows.

→ Normal → Night →

[Normal]: Normal sound.

[Night]: Volume is lowered without changing the sound quality. The volume of sudden loud sounds, etc. is also suppressed.

OTHER BASIC OPERATIONS

DISPLAY

Press **DISPLAY**.

Press this button to display the Program No., input mode, and screen size status.

OFF TIMER

This function allows you to set the length of time before the display automatically goes into standby state.

Press **OFF-TIMER**.

The standby state is placed when the set time has passed.

Each time the button is pressed, the time setting is switched as shown below.

→ 30min. → 60min. → 90min. → 120min.
→ Off →

PICTURE MODE

This function switches the picture mode.

Press **FINE**.

Each time the button is pressed, the mode is switched between the current picture mode and Fine mode.

* See P. E-26 for how to set Picture Mode.

* While you are watching pictures in Fine mode, pressing the button does not switch the mode.

PICTURE MEMORY

This function calls pictures which have been adjusted and registered. This button toggles among eight preset picture adjustment groups loaded into memory.

Press **Picture MEMORY**.

Each time the button is pressed, the picture memory is switched as shown below.

→ Memory1 → Memory2 → Memory3 →
Memory4 → Memory5 → Memory6 →
Memory7 → Memory8 →

* See P. E-30 for how to set Picture Memory.

Note

- When the WIDE mode is set to "Normal", and pictures are shown for an extended time, a residual image or "burn-in" may be created. The burn-in may occur at the boundary where the left and right borders of the picture meet the vertical bars. To reduce the chance of "burn-in" when watching in the "Normal", we recommend you set the "Background" to "Light Gray". (See P. E-39)
- When a residual image was created, it is reduced by using the "White Screen" settings. Note that there may also be cases when it can not be recovered completely. (See P. E-39)
- A variety of Screen Sizes are available with this display. Remember that if you select a mode with an aspect ratio (ratio of frame width to frame height) different from that of the TV program or video media, the pictures will appear differently than if you had selected a mode having the same aspect ratio.
- Showing a movie or similar premium event at a different aspect ratio from its original one at any event site, restaurant, or bar for profit-making purposes or for a public audience may constitute a copyright infringement.
For films, try to select a mode having the same aspect ratio as the original picture; this enables the director's original intentions to be preserved.
- See P. E-32 for how to adjust the picture position and size.

WIDE

This function switches among available picture display modes.

1

Press **WIDE**.

The currently selected mode will appear.

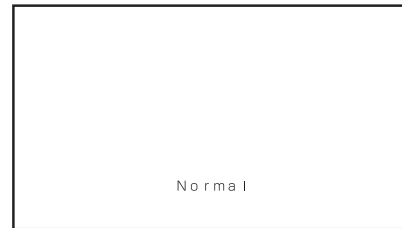

Normal mode

2

Press **WIDE** to select a desired display mode.

Each time you press **WIDE**, a different display mode appears. Here are the display mode sequences.

- TV, Video mode (HD signal)
→ Wide1 → Wide2 → True Signal →
- TV, Video mode (SD signal)
→ Normal → Wide1 → Wide2 → Zoom1 →
Zoom2 →
- RGB mode
→ Normal → Wide → Zoom →

* Depending on the type of signal, some aspects may not be selected.

* See P. E-32 for how to adjust the display size and position.

* The buttons on the display can also be used for adjustments and settings.

SCREEN SIZE

Normal

Displaying normal size picture (i.e. a 4:3 aspect ratio).

Wide1

- TV / Video mode (SD signal)

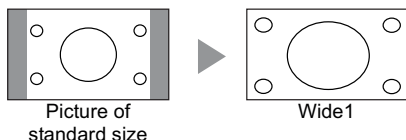

Displays natural-looking pictures of standard size on the wide screen.

- TV / Video mode (HD signal)
- Displays Wide size (16:9 aspect ratio) pictures.

Wide2

- TV / Video mode (SD signal)

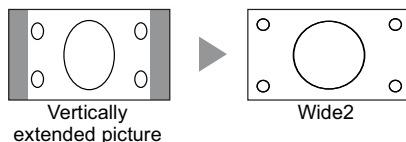

Ideal for displaying vertically extended pictures such as anamorphic (squeezed widescreen) pictures.

- TV / Video mode (HD signal)

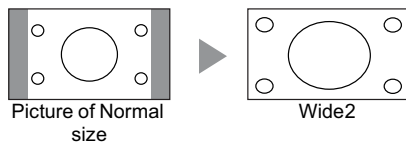

An HD signal picture displayed in Normal size is displayed as wide screen with minor image stretching.

Wide

Displays Normal size picture as wide screen.

True Signal

Displays a pure picture without expansion or contraction of the picture signal. (for 1080i / 1080P signal)

Note

- Depending on the type of signal, some aspects may not be selected.
- You may find dark areas on top and at the bottom of the screen even if you select one of the Zoom modes for media while using the Vista Vision or Cinema Scope size i.e. sizes frequently used for movie.

Zoom1/Zoom

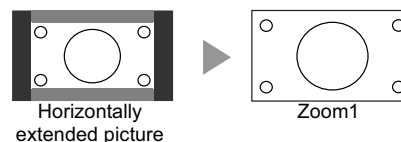

Enlarges horizontally extended pictures equally in all directions to maintain the aspect ratio constant.

Zoom2

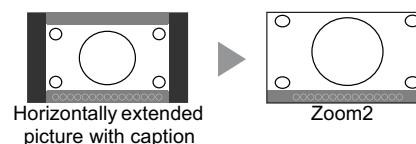

Reduces the height of horizontally extended pictures with captions, without eliminating the caption. Only the height of pictures is reduced, not the height of the caption.

(Captions may not be easy to read, however, depending on the picture.)

* The Zoom mode display method may be different, depending on the input signal.

ASPECT RATIO

The following aspect ratios are available.

VHF/UHF broadcasting, BS broadcasting

4:3 aspect ratio

HDTV broadcasting

16:9 aspect ratio

Vista Vision size

1.85:1 aspect ratio

Cinema Scope size

2.35:1 aspect ratio

ADJUSTMENT MENU

The numbers in parentheses () indicate the reference page numbers.

Display Menu (E-26)	PICTURE (E-26)	Signal Contrast (E-26)			
		Drive Contrast (E-26)			
		Brightness (E-26)			
		Color (E-26)			
		Tint (E-26)			
		Sharpness (E-26)			
		Ambient Sensor (E-26)			
		Picture Mode (E-26)			
		Precision Setting (E-27)	Black Level (E-27)		
			Detail Gradation (E-27)		
			3D NR (E-27)		
			CODEC NR (E-27)		
			Image Enhance (E-27)	Image Identify (E-27)	
				Chroma Transient (E-27)	
			Color Temp. (E-27)		
			User Color Temp. (E-27)		
			Color Tuning (E-28)		
			Progressive Scan (E-28)	24 Frame Mode (E-28)	
				30 Frame Mode (E-28)	
				Jaggies Filter (E-29)	
		Motion Setting (E-29)			
	Gamma (E-29)	High Point (E-29)			
		High Point Gain (E-29)			
		Low Point (E-29)			
		Low Point Gain (E-29)			
	ALC Setting (E-29)	High Point Level (E-29)			
		High Point Gain (E-29)			
		High Point Limit (E-29)			
		Low Point Level (E-29)			
		Low Point Gain (E-29)			
		Low Point Limit (E-29)			
	Picture Memory (E-30)	Load (E-30)			
		Save (E-30)			
	Default				
	AUDIO (E-31)	Treble (E-31)			
		Bass (E-31)			
		Balance (E-31)			
		Loudness (E-31)			
		Sound Mode (E-31)			
	POSITION/SIZE (E-32)	Position (E-32)	Horizontal (E-32)		
			Vertical (E-32)		
		Size (E-32)	Width (E-32)		
			Height (E-32)		
		Default			
	FEATURES (E-33)	Adjustment (E-33)	Dot Clock (E-33)		
			Clock Phase (E-33)		
			Clamp Position (E-33)		
			Auto Calibration (E-33)		
		On Screen Menu (E-33)	OSD (E-33)		
			Language (E-33)		
			Name Select (E-34)		
		Input Terminal (E-34)	D-SUB Input (E-34)		
		Clock Set (E-34)			
		CC Service (E-34)	Display (E-34)		
			Digital (E-35)		
			Size (E-35)		
			Style (E-35)		
			Text (E-35)		
			Color (E-35)		
			Opacity (E-35)		
			Background (E-35)		
			Color (E-35)		
			Opacity (E-35)		
			Style (E-35)		
			Color (E-35)		
		Auto Lock (E-36)	Parental Ctrl By Level (E-36)		
			Parental Ctrl By Ch (E-37)		
			New Password (E-37)		
		Others (E-38)	Auto Off-NO SIG. (E-38)		
			Time (E-38)		
			Background (E-38)		
			Audio Input (E-38)		
			Digital Audio Format (E-38)		
			Screen Orbiter (E-38)		
			Mode/Time (E-38)		
			Moving Area (E-38)		
			Direct Setting (E-39)		
			Code Setting (E-39)		
			White Screen (E-39)		
			Background (E-39)		
			Information (E-39)		
	FACTORY DEFAULT (E-40)				
TV Menu (E-41)	Channel Setting (E-41)	Auto Scan (E-41)			
		Channel Edit (E-41)			
		Favorite Ch (E-42)			
		Multi Ch Audio (E-42)			
		Audio Language (E-42)			
		Fact Ch Reset (E-42)			
	CableCARD (E-42)				
	Emergency Alert (E-42)				
IEEE 1394 (E-43)	Standby Mode (E-43)				

Note

- Some type of signal can not be selected.

BASIC PROCEDURES OF ADJUSTMENT MENU

- Shown below is the basic procedure used to change the options on the ADJUSTMENT MENU. (Ex.: Adjusting tint setting (Tint))
- Selecting the adjustment mode for adjustment or setting. (The items to be adjusted or set are stored for each adjustment mode.)

1 Press **MENU**.



The main menu screen will appear.

2 Press **▲** or **▼** to select "Display Menu" and press **▶** or **ENTER**.

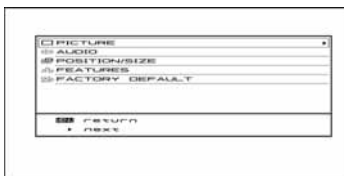

"Display Menu" selected in the main menu screen

The "Display Menu" appears.

3 Press **▲** or **▼** to select "PICTURE" and press **▶** or **ENTER**.

Each time you press **▲** or **▼**, one of the available menus appears in the following sequence:

PICTURE ↔ AUDIO ↔ POSITION/SIZE ↔ FEATURES ↔ FACTORY DEFAULT

The "PICTURE" menu screen will appear.



"PICTURE" selected in the main menu screen

4 Press **▲** or **▼** to select "Tint".

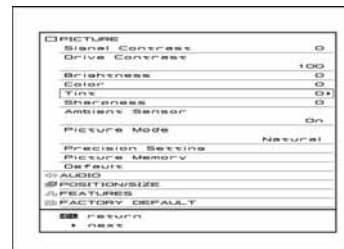

"Tint" selected in the PICTURE Menu screen

5 Press **▶** or **ENTER**, and press **◀** or **▶** to change Tint values.



"Tint" adjustment screen

▶: More greenish colors

◀: More purplish colors

6 Press **ENTER** to store.

7 Press **MENU** or **EXIT** when you finish.

* Repeat steps 3, 4, 5 and 6 when you wish to make changes to other options.

* Select "Default", press **ENTER**, select "YES" and press **ENTER**. The PICTURE items are changed back to the default settings available when the display was purchased.

* Press **MENU** or **EXIT** to halt the operation in progress.

Note

- If the operation is not executed for about 60 seconds, the menu disappears.
- Depending on the model, or the types of signals, some of the functions may not be available.
- The adjustment range varies according to the display signals. Make adjustments to your preferred picture quality within the adjustment range.
- Depending on the type of signal, it may not be possible to make some of the settings or adjustments.

ADJUSTING TO A DESIRED PICTURE (PICTURE MENU)

- Picture-related items can be set and adjusted in the Picture Adjustment Screen. See BASIC PROCEDURES OF ADJUSTMENT MENU on page E-25 for the basic procedures.

Signal Contrast

"Signal Contrast" can be adjusted.

Press  to increase contrast.

Press  to reduce contrast.

Press  to store.

Drive Contrast

"Drive Contrast" can be adjusted.

Press  to raise the display's luminance level, and increase the contrast.

Press  to lower the display's luminance level, and reduce the contrast.

Press  to store.

- * If Ambient Sensor is ON, the change made by this adjustment may be difficult to be recognized in too bright or dark a place.
- * When the temperature inside the product is high, changes when this adjustment was made may be difficult to comprehend.

Brightness

"Brightness" can be adjusted.

Press  to increase the brightness.

Press  to reduce the brightness.

Press  to store.

Color

"Color" can be adjusted.

Press  to darken the color.

Press  to lighten the color.

Press  to store.

Tint

"Tint" can be adjusted.

Press  to change the tint to a more greenish color.

Press  to change the tint to a more purplish color.

Press  to store.

Sharpness

"Sharpness" can be adjusted.

Press  to sharpen the Sharpness.



Press  to soften the Sharpness.

Press  to store.

Ambient Sensor

"Ambient Sensor" can be set.

Automatically adjusts the picture quality to an optimized level that matches the brightness of the ambient light.



Each time  or  is pressed, the setting is switched.

↔ On ↔ Off ↔

Press  to store.

Picture Mode

"Picture Mode" can be set.

Each time you press  or , the available choices appear in the following sequence.

↔ Natural ↔ Fine ↔ Effective ↔ Conventional ↔ Still ↔

Natural	Enables you to watch pictures with natural color tones and high picture clarity. This mode is suitable for watching movies or TV.
Fine	Best for watching movies in darkened rooms.
Effective	Best for watching TV in bright environments.
Conventional	Displays a screen approximating that of a conventional TV screen.
Still	Suitable for watching static images such as computer or still camera images.

Press  to store.

Precision Setting

Even more advanced picture quality adjustments can be made as required.



Precision Setting Selection Screen

Black Level

Press \blacktriangleleft to strengthen the reproduction of black. (Provides a picture quality with deep blacks.)

Press \blacktriangleright to weaken the reproduction of black.

Press ENTER to store.

Detail Gradation

Corrects the gradation of the light and dark areas of the picture.

Each time \blacktriangleleft or \blacktriangleright is pressed, the setting is switched.

\leftrightarrow On \leftrightarrow Off \leftrightarrow

Press ENTER to store.

3D NR

This enables noise reduction processing with respect to the input signal noise level (reduces screen flicker for more comfortable viewing).

Each time you press \blacktriangleleft or \blacktriangleright , the available choices appear in the following sequence.

\leftrightarrow Off \leftrightarrow Min. \leftrightarrow Mid. \leftrightarrow Max. \leftrightarrow

Press ENTER to store.

CODEC NR

This enables noise reduction processing of mosquito noise or block noise generated when digital picture signals are recorded or replayed.

Each time you press \blacktriangleleft or \blacktriangleright , the available choices appear in the following sequence.

\leftrightarrow Off \leftrightarrow Min. \leftrightarrow Mid. \leftrightarrow Max. \leftrightarrow

Press ENTER to store.

Note

- If the operation is not executed for about 60 seconds, the menu disappears.
- Depending on the model, or the types of signals, some of the functions may not be available.
- The adjustment range varies according to the display signals. Make adjustments to your preferred picture quality within the adjustment range.
- Depending on the type of signal, it may not be possible to make some of the settings or adjustments.

Image Enhance

This performs detailed image quality settings.

• Image Identify (RGB)

This function discerns between the natural image display section and the text display section, and performs correction to enable an optimized display for each.

Each time \blacktriangleleft or \blacktriangleright is pressed, the setting is switched.

\leftrightarrow On \leftrightarrow Off \leftrightarrow

Press ENTER to store.

• Chroma Transient

This function corrects the color contours.

Each time \blacktriangleleft or \blacktriangleright is pressed, the setting is switched.

\leftrightarrow On \leftrightarrow Off \leftrightarrow

Press ENTER to store.

Color Temp.

Use \blacktriangleleft or \blacktriangleright to specify a desired color temperature. Each time you press \blacktriangleleft or \blacktriangleright , one of the available choices appears in the following sequence:

\leftrightarrow -3500K \leftrightarrow ... \leftrightarrow Std. \leftrightarrow ... \leftrightarrow +3500K \leftrightarrow User \leftrightarrow

[-3500K]: More reddish colors

[+3500K]: More bluish colors

[User]: User Color Temp. setup

Press ENTER to store.

User Color Temp.

Use \blacktriangleup or \blacktriangledown to select Red, Green, or Blue, and adjust the color temp. for each.

Press \blacktriangleright to strengthen the selected color.

Press \blacktriangleleft to weaken the selected color.

Press ENTER to store.

ADJUSTING TO A DESIRED PICTURE (PICTURE MENU) (Continued)

Color Tuning

This enables correction with respect to specific color hues within the image.

Independent correction of the hue of skin colors, blue skies, and so on, enables a more brilliant display.

	R	G	B	Y	C	M	W
Color	0	0	0	0	0	0	0
Tint	0	0	0	0	0	0	0
R Gain	0	0	0				0
G Gain	0	0	0				0
B Gain	0	0	0				0

apply
select

Color Tuning Settings Screen

- Use , , , or to select the item you want to adjust.

When is pressed, the value to be changed blinks.

- Use or to make the adjustment.

The adjustment contents can be checked at the screen displayed at the Custom side.

- When is pressed, the set data are stored and the product exits from the input mode.

* When is pressed without pressing , the product exits from the input mode without storing the data.

[R (Reddish color)]

Color, Tint, R Gain, G Gain, and B Gain correction is performed within the range from magenta to yellow, centered about red.

[G (Greenish color)]

Color, Tint, R Gain, G Gain, and B Gain correction is performed within the range from yellow to cyan, centered about green.

[B (Bluish color)]

Color, Tint, R Gain, G Gain, and B Gain correction is performed within the range from cyan to magenta, centered about blue.

[r (targeting red)]

Corrects the Color and Tint for red.

[y (targeting yellow)]

Corrects the Color and Tint for yellow.

[g (targeting green)]

Corrects the Color and Tint for green.

[c (targeting cyan)]

Corrects the Color and Tint for cyan.

[b (targeting blue)]

Corrects the Color and Tint for blue.

[m (targeting magenta)]

Corrects the Color and Tint for magenta.

[w (targeting white)]

Corrects the R Gain, G Gain, and B Gain for white.

Progressive Scan

This sets the conversion processing of interlace signals to block receive signals.

	24 Frame Mode	30 Frame Mode
24 Frame Mode	Auto	Off
30 Frame Mode	Auto	Off

apply
select

Progressive Scan Settings Screen

• 24 Frame Mode

This function enables the optimized display of movies, etc. with 24 frames/second signals.

Each time or is pressed, the setting is switched.

↔ Auto ↔ Off ↔

Press to store.

• 30 Frame Mode

This function enables the optimized display of movies, etc. with 30 frames/second signals.

Each time or is pressed, the setting is switched.

↔ Auto ↔ Off ↔



Press to store.

Note

- If the operation is not executed for about 60 seconds, the menu disappears.
- Depending on the model, or the types of signals, some of the functions may not be available.
- The adjustment range varies according to the display signals. Make adjustments to your preferred picture quality within the adjustment range.
- Depending on the type of signal, it may not be possible to make some of the settings or adjustments.

• Jaggies Filter

This function alleviates the phenomenon where jagged diagonal lines can be seen when interlace signals are input, thus enabling a smoother motion picture display.

Each time  or  is pressed, the setting is switched.

↔ Auto ↔ Off ↔

Press  to store.

• Motion Setting

The detecting sensitivity for motion picture is set.

The response of the picture processing is valued in the motion picture priority setting.

Press : to specify still picture priority.

Press : to specify motion picture priority.



Press  to store.

Gamma

You can create your favorite image by fine tuning the brightness.

• High Point

In a bright image scene, sets the point where the brightness is to be adjusted.

Press  or  to set the point where the brightness is to be adjusted.

Press  to store.

• High Point Gain

Fine tunes the brightness of the point set by High Point.



Press  to be darker.

Press  to be brighter.

Press  to store.

• Low Point

In a dark image scene, sets the point where the brightness is to be adjusted.

Press  or  to set the point where the brightness is to be adjusted.

Press  to store.

• Low Point Gain

Fine tunes the brightness of the point set by Low Point.

Press  to be darker.

Press  to be brighter.

Press  to store.

ALC Setting

- This function allows setting of the screen to your favorite luminance matched to the ambient brightness.
- The ALC Setting function operates when the ambient sensor is turned on. (See "Ambient Sensor" on P. E-26.)

• High Point Level

Sets the upper limit value of the ambient brightness detected by the ambient sensor.

Press  to lower the upper limit value.

Press  to raise the upper limit value.

Press  to store.

• High Point Gain

Sets the upper limit value of the screen luminance corresponding to the brightness detected by the ambient sensor in a bright environment.



Press  to lower the upper limit value.

Press  to raise the upper limit value.

Press  to store.

• High Point Limit

Limits control of the screen luminance corresponding to the ambient sensor when the value detected by the ambient sensor exceeds the High Point Level and High Point Gain.

Each time  or  is pressed, the setting is switched.

[On]: Limit operates

[Off]: Limit does not operate

Press  to store.

• Low Point Level

Sets the lower limit value of the ambient brightness detected by the ambient sensor.

Press  to lower the lower limit value.

Press  to raise the lower limit value.

Press  to store.

• Low Point Gain

Sets the lower limit value of the screen luminance corresponding to the brightness detected by the ambient sensor in a dark environment.



Press  to lower the lower limit value.

Press  to raise the lower limit value.

Press  to store.

• Low Point Limit

Limits control of the screen luminance corresponding to the ambient sensor when the value detected by the ambient sensor is lower than the Low Point Level and Low Point Gain.

Each time  or  is pressed, the setting is switched.

[On]: Limit operates

[Off]: Limit does not operate

Press  to store.



ADJUSTING TO A DESIRED PICTURE (PICTURE MENU) (Continued)

Picture Memory

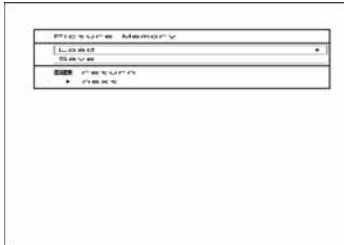
Eight groups of picture adjustment settings can be stored, enabling you to quickly switch to your desired group of settings for watching program.



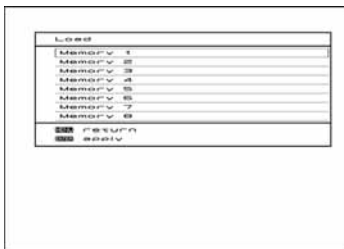

Picture Memory Selection Screen

[Load]: When memory 1~8 is selected using  or , the image adjustment value becomes the value registered in selected memory 1~8.



"Load" Selection Screen

[Save]: Use  or  to select Memory 1 - 8. If  is pressed, the current picture adjustment values are stored to the selected Memory.

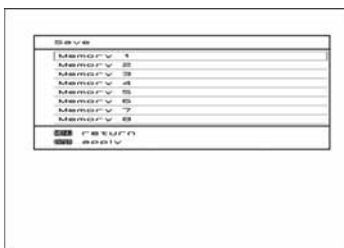

"Save" Selection Screen

ADJUSTING TO DESIRED AUDIO (AUDIO MENU)

- You can make changes to all audio adjustment options in the AUDIO Menu. See Page E-25 for the basic procedures.
- The changes you make will be stored for the selected input mode. Therefore, you need to select a desired input mode before making any changes.

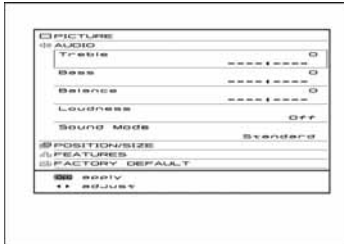

AUDIO Menu screen

Treble

Press or to make adjustments.

: Stronger treble

: Weaker treble

Press to store.

Bass

Press or to make adjustments.

: Stronger bass

: Weaker bass

Press to store.

Balance

Press or to make adjustments.

: Shifts the volume balance towards the right.

: Shifts the volume balance towards the left.

Press to store.

Loudness

Corrects the balance between bass and treble for easy listening even with weak volume.

Each time you press or , one of the available choices appears in the following sequence:

↔ Off ↔ Min. ↔ Mid. ↔ Max. ↔

Press to store.

Sound Mode

Sets the sound field.

Each time or is pressed, the setting is switched.

↔ Flat ↔ Standard ↔ Voice ↔ Surround ↔

[Flat]: Reproduces the sound input signal naturally. Mild sound reproduction is realized.

[Standard]: Listening-fatigue-free, placid sound reproduction is realized by suitable equalizing (sound quality adjustment).

[Voice]: Increases the sound clarity. Announcements, dialogue, etc. become easy to hear.

[Surround]: Sound image is spread left, right, up, and down. Sound with the realistic sensation of a movie, etc. is enjoyed.

Press to store.

Note

- If the operation is not executed for about 60 seconds, the menu disappears.
- An audio signal from an audio output terminal (AUDIO OUTPUT DIGITAL or AUDIO OUTPUT ANALOG) does not change.
- AUDIO menu will not be displayed when "No Audio" is selected. (See P. E-38)

ADJUSTING SCREEN POSITION AND SIZE (POSITION/SIZE MENU)

- You can make changes to all screen adjustment options in the POSITION/SIZE Menu.
- See Page E-25 for the basic procedures.



POSITION/SIZE Menu screen

- The changes you make will be stored for the selected input mode. Therefore, you need to select a desired input mode before making any changes.
- The adjustment range may vary depending on the input signal.

Position



"Position" adjustment screen

Horizontal position (Horizontal)

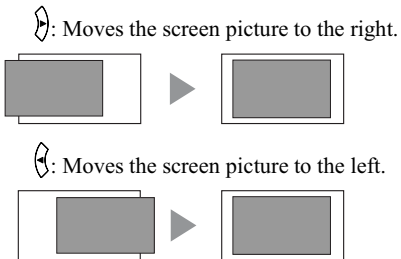

Vertical position (Vertical)

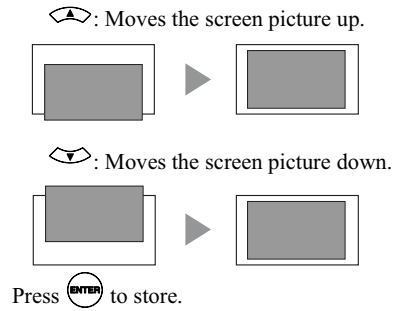

Size

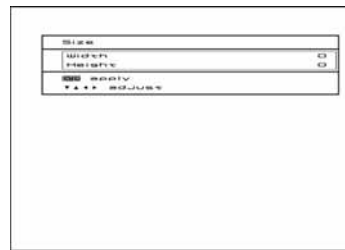

"Size" adjustment screen

Screen width (Width)

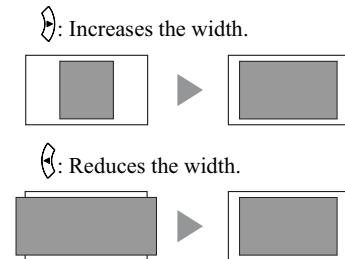

Screen height (Height)

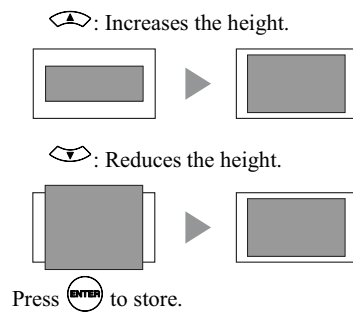

Note

- Depending on the model or the optional devices, some of the functions may not be available. (The adjustment screen may also vary slightly.)
- The adjustment range varies according to the display signals. Make adjustments to your preferred picture quality within the adjustment range.
- Depending on the type of signal, it may not be possible to make some of the settings or adjustments.

- To adjust or set items such as Adjustment, On Screen Menu, Input Terminal, and Channel Setting, select "FEATURES" from the adjustment menu. See P. E-25 for the basic procedures.
- The items to be adjusted or set are stored for each input mode. Thus, execute the following operation after selecting the input mode for the adjustment or setting.



ADJUSTMENT ITEMS

Dot Clock

for RGB

You may find the vertically-striped pattern in pictures, depending on the clock frequency of your PC's processor.

If you experience blurring, you can obtain a clearer picture by adjusting the "Dot Clock".

Use  or  to adjust to minimize vertically-striped pattern in pictures.

Press  to store.

Clock Phase



for RGB

Pictures and the outline of letters may blur or flicker as the clock phase of your PC may be different. In this case, adjust the clock phase manually. Normally, the "Auto" setting ensures the optimal value.

Use  or  to select "Auto" or "Manual".

[Auto]: Makes automatic adjustment.



[Manual]: Makes manual adjustment.

Press  or  to adjust to minimize pictures blur.

Press  to store.

Clamp Position for RGB, Component Video

Adjusts the extremely dark or bright picture. Normally, the automatic setting ensures the optimal value.

Use  or  to adjust pictures optimally.



Press  to store.

Auto Calibration

for RGB

Adjusts the dynamic range of picture to the optimum. Execute while a white screen signal is received.

(1) Select "Execute" and press .

(2) Press  or  to select "YES", and press .

Note

- If the operation is not executed for about 60 seconds, the menu disappears.
- Depending on the model, some of the functions may not be available. (The adjustment screen may also vary slightly.)
- The adjustment range varies according to the display signals. Make adjustments to your preferred picture quality within the adjustment range.
- Depending on the type of signal, it may not be possible to make some of the settings or adjustments.



ON SCREEN MENU SETTING



"On Screen Menu" Screen

OSD

You can use this option to select from following display indication.

Each time you press  or , one of the available choices appears in the following sequence:

↔ On (OSD:bright) ↔ On (OSD:dark) ↔

[On (OSD:bright)]: On-screen information shown in light color.

[On (OSD:dark)]: On-screen information shown in dark color.

Press  to store.

* If the screen picture is too bright, some characters may be difficult to watch when [On (OSD:dark)] is selected.

Language

You can use this option to select the language displayed on the screen.

Press  or  to select your desired language.

English

Español (Spanish)

Français (French)

Press .

The menu is displayed in the selected language.



OTHER SETTINGS (FEATURES MENU) (Continued)

Name Select

You can change the settings for indications for video inputs and RGB inputs.

RGB input

You can change the settings for indications for the RGB inputs. Select the desired indication in accordance with the connected equipment.

Each time  or  is pressed, the setting is switched.



↔ RGB1 ↔ PC1 ↔ PC2 ↔ DVD1 ↔ DVD2 ↔ STB ↔
Satellite ↔ Cable TV ↔

Press  to store.

Video input

You can change the settings for indications for the VIDEO inputs.

Select the desired indication in accordance with the connected equipment.

Each time  or  is pressed, the setting is switched. (In the case of VIDEO1)

↔ Video1 ↔ DVD1 ↔ DVD2 ↔ VCR1 ↔ VCR2 ↔
GAME ↔ Camcorder ↔ STB ↔ Satellite ↔ Cable TV ↔

Press  to store.

Input Terminal SETTING

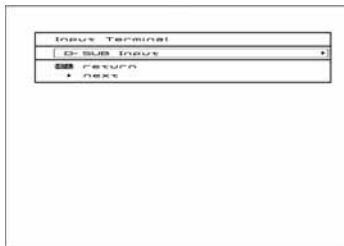

"Input Terminal" Screen



Selecting the settings of D-SUB Input terminal

You can use this option to select the signal system it will receive to D-SUB Input terminal.

(1) Select D-SUB Input and press .

D-SUB Input screen appears.

(2) Select the signal system to receive.

Each time you press  or , one of the available choices appears in the following sequence:

↔ RGB-PC ↔ Decoder ↔





[RGB-PC]: For using RGB of PC



[Decoder]: For using digital broadcast tuner

(3) Press  to store.

Clock Set SETTING

The date and time can be set.

Press  or  to select the item, and press  or  to set it.

Each time  or  is pressed, the items are selected in the following sequence:

Year ↔ Month ↔ Day ↔ Hour ↔ Minute ↔

Time Zone ↔ Daylight Saving

* The display clock has a function which automatically acquires the time information from TV Guide On Screen and corrects it to the newest state. Since TV Guide On Screen is used, always initialize TV Guide On Screen beforehand.

CC (Closed Caption) Service SETTING

The closed caption service setting procedure is as follows.

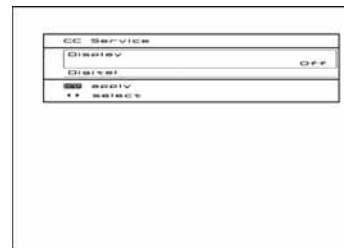



"CC Service" Screen

* The Closed Caption Service is available only when current TV program or video picture has the service information.

* This function does not work in VIDEO5,6 (HDMI).

Display

This function determines whether to turn ON/OFF the closed caption service.

Press  or  to switch between the items.

↔ On ↔ Off ↔



Press  to store.

Digital

This function sets the closed caption service for digital mode. Settings such as program service, character style, and character size can be selected using the following functions.

Size

A target character size can be set.



Press  or  to switch among the items.

↔ Standard ↔ Large ↔ Small ↔

Press  to store.

Style

A target character style can be set.

Press  or  to switch among the items.



↔ Default ↔ Style1 ↔ Style2 ↔ Style3 ↔ Style4 ↔

Style5 ↔ Style6 ↔ Style7 ↔



Press  to store.

Text

The color and transparency of characters can be set.

Press  or  to select Color/Opacity.

- Color



Press  or  to switch among the items.

↔ Black ↔ White ↔ Red ↔ Green ↔ Blue ↔ Yellow ↔

Magenta ↔ Cyan ↔

Press  to store.

- Opacity



Press  or  to switch among the items.

↔ Solid ↔ Flashing ↔ Translucent ↔ Transparent ↔



Press  to store.

Background

The color of the background and transparency can be set.

Press  or  to select Color/Opacity.

- Color



Press  or  to switch among the items.

↔ Black ↔ White ↔ Red ↔ Green ↔ Blue ↔ Yellow ↔

Magenta ↔ Cyan ↔

Press  to store.

- Opacity



Press  or  to switch among the items.

↔ Solid ↔ Flashing ↔ Translucent ↔ Transparent ↔

Press  to store.

Edge

The edge and color of characters can be set.

Press  or  to select Style/Color.

- Style

Press  or  to switch among the items.

↔ None Text Edge ↔ Raised ↔ Depressed ↔ Uniform

↔ Left Shadow ↔ Right Shadow ↔

Press  to store.

- Color

Press  or  to switch among the items.

↔ Black ↔ White ↔ Red ↔ Green ↔ Blue ↔ Yellow ↔

Magenta ↔ Cyan ↔

Press  to store.

Note

- If the operation is not executed for about 60 seconds, the menu disappears.
- Depending on the model, or the types of signals, some of the functions may not be available.
- The adjustment range varies depending on the display signal. Adjust to a desired picture quality in the allowable adjustment range.
- Setting and adjustment may be disabled depending on the signal type.

OTHER SETTINGS (FEATURES MENU) (Continued)

Auto Lock (Parental Lock) SETTING

Auto Lock is provided for the parents to determine that TV programs and video pictures not good for their children are blocked.

Restrictions on the watching of TV programs can be placed by channel, age, and program category.

Parental Ctrl By Level

Sets MPAA system and TV RATING system program viewing restriction at the television channel and video input.

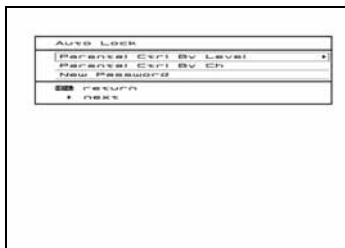

"Auto Lock" Screen

Select Parental Ctrl By Level by or and press .

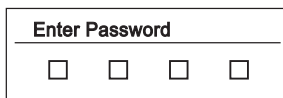

"Enter Password" Screen

Enter the Password.

(initial value: " ")

Placing restrictions on the watching of TV programs by channel or age.

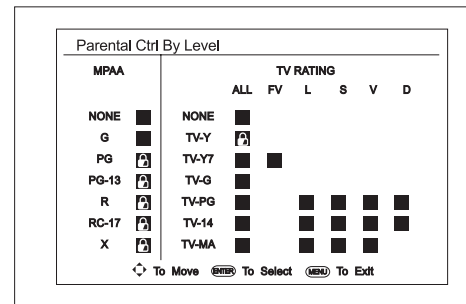

Press , , , or to select a target item.

Press to switch between blocking and unblocking.

Description of MPAA chart symbols

NONE	MPAA chart Lock are all cleared.
G	For the general audience of all ages
PG	Parental guidance suggested. Some programs are not good for children.
PG-13	Some programs are not good for children at age 13 years or younger.
R	Parents' permission required for children at age 17 years or younger
NC-17	Not for children at age 17 years or younger
X	For adults only

Description of TV RATING symbols

NONE	TV RATING chart Lock are all cleared.
TV-Y	For children of all ages
TV-Y7	For children of at age 7 years or older
TV-G	For general audience
TV-PG	Parents' permission is required.
TV-14	Firm warning to parents Program parents would find unsuitable for children under 14 years of age.
TV-MA	For adults only
FV	Fantasy Violence
L	Adult Language
S	Sexual situations
V	Violence
D	Suggestive Dialogue

Note

About Auto Lock (Parental Lock)

- Auto Lock can be set for TV and video inputs by age and program category.
- The Auto Lock system of the display is compatible with both TV Rating system and MPAA system.
- The Auto Lock system is available for both analog TV broadcastings and digital TV broadcastings.
- Once Auto Lock is set, the display does not show the restricted program (neither pictures nor audio) when receiving it.
- When receiving a program for which Auto Lock is set, the display shows the "Program Blocked" screen. To show the program, enter the password. All the settings for Auto Lock are reset temporarily when the password is entered. To enable Auto Lock, turn off the power (STANDBY), and then turn it ON again. Also, when or other operation is performed, or the power is turned on/off, while the "Program Blocked" screen is displayed, the screen may become blank. Also, when or other operation is performed, or the power is turned on/off, while the "Program Blocked" screen is displayed, the screen may become blank. In this case, reselect the program you want to watch by pressing or .
- The Auto Lock system is available only for TV broadcastings and video signals (Video mode, S-Video mode and Comp.video(480i) mode) that are based on the parental lock standard. The Auto Lock feature will work only when a program rating is available.
- This function does not work in VIDEOS,6 (HDMI).

Parental Ctrl By Ch

Viewing control can be turned on and off for the channel to be viewed.

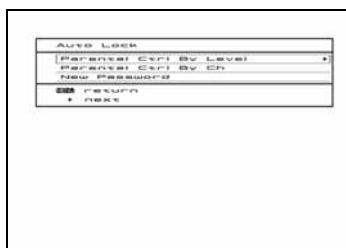

"Auto Lock" Screen

Select Parental Ctrl By Level by or and press .

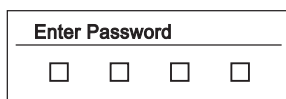

"Enter Password" screen

Enter the Password.

(initial value: " ")

A channel listing is displayed.

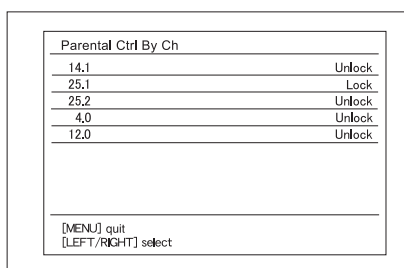

"Parental Ctrl By Ch" Screen

Press or to select a target item.

Press or to switch between blocking (Lock) and unblocking (Unlock).

* When a blocked channel is viewed, "Program blocked" display appears.

New Password

Performed when changing the Password.

Select New Password by or and press .



"Old Password" Screen

(1) Enter Old Password by 4-digit number from to .

(2) Enter New Password by 4-digit number from to .

(3) Enter New Password again.

Memorize by pressing .

Password is changed and memorized.

* It is important to note your password for future use.

Note

- If the operation is not executed for about 60 seconds, the menu disappears.
- Depending on the model, or the types of signals, some of the functions may not be available.
- The adjustment range varies depending on the display signal. Adjust to a desired picture quality in the allowable adjustment range.
- Setting and adjustment may be disabled depending on the signal type.

OTHER SETTINGS (FEATURES MENU) (Continued)

SETTING OTHERS

Auto Off-NO SIG.

Adjusting the settings so that the standby state automatically starts up if the display remains in no signal state for an extended amount of time.

Selecting the background setting to indicate when the display is in the no signal state.



"Auto Off-NO SIG." selection screen

Time

- (1) Press or to select the "Time".
- (2) Press or to select the amount of time before the standby state starts.
 ↔ Off ↔ 1 min. ↔ 15 min. ↔ 45 min. ↔ 60 min. ↔
 Press to store.
 * The numerical value is the approximate amount of time before the standby state starts.

Background

- (3) Press or to select the "Background".
- (4) Press or to select the display background color.
 ↔ Black ↔ White ↔
 Press to store.
 * The background color changes to assigned color state after approximately 20 seconds in the no signal state.

Audio Input



"Audio Input" settings screen

Selecting the available terminals to receive audio from the input equipment .

- (1) Press or to select video input terminal.
- (2) Select a related audio input terminal.
 Each time you press or , one of the available choices appears in the following sequence:
 ↔ No Audio ↔ Audio1 ↔ Audio2 ↔ . . . ↔
[No Audio]: No audio in the corresponding mode. (No audio is output even when this video input mode is selected.)

[Audio 1-3]: Selects Audio 1 through 3 for receiving audio in the corresponding mode.

[Audio 4-5]: HDMI

- * There is also "Audio Input" that cannot be selected.
- (3) Press to store.
- * For the audio input terminals, see "CONNECTING TO EXTERNAL EQUIPMENT" (P. E-17) and EXAMPLE OF CONNECTING EXTERNAL EQUIPMENT" (P. E-18).
- * AUDIO menu will not be displayed when "No Audio" is selected.

Digital Audio Format

You can select the audio format for the signal output from AUDIO OUTPUT DIGITAL terminal.

Switches as below by pressing or .

↔ PCM ↔ Dolby Digital ↔

Press to store.

- * When a program featuring Dolby Digital audio is selected, the sound comes from the AUDIO OUTPUT DIGITAL terminal.
- * To receive programs available in Dolby Digital sound, set the "D Audio Format" of the on-screen menu to Dolby Digital.
- Programs that are not available in Dolby Digital sound will be output in PCM, even if the AUDIO OUTPUT DIGITAL is set to "Dolby Digital".

Screen Orbiter

for RGB



You can use this option to move the screen position to minimize phosphor-induced "burn-in".

Mode/Time



- (1) Press or to select "Mode/Time".
- (2) Select a desired pattern.
 Each time you press or , one of the available choices appears in the following sequence:
 ↔ Off ↔ Time ↔ Mode ↔
[Off]: Disables Screen Orbiter.
[Time]: Moves the pattern approximately every one hour.
[Mode]: Moves the pattern when the power is turned ON or when you switch between modes.

Moving Area

- (3) Press or to select "Moving Area".
- (4) Press or to select the range for moving the pattern.
 Each time you press or , one of the available choices appears in the following sequence:
 ↔ Min. ↔ Std. ↔ Max. ↔
[Min.]: Pattern moves in small range. (About 5 pixels)
[Std.]: Pattern moves in moderate range. (About 10 pixels)
[Max.]: Pattern moves in wide range. (About 15 pixels)
- (5) Press to store.
 * When the Screen Orbiter function is operated, some screen contents. at the top, bottom, right or left of the screen may move offscreen.

Direct Setting for RGB

You can use this option to switch the setting for RGB input signal.

Each time you press  or , one of the available choices appears in the following sequence:

↔ Auto ↔ VGA ↔ WVGA ↔ 480P ↔ XGA ↔ WXGA
↔ SXGA ↔ SXGA+ ↔

[Auto]: The optimum display is obtained automatically for input signals.

[Other than Auto]: The optimum resolution setting is fixed for each signal.

Press  to store.

* In Auto mode, the resolution of VGA, WVGA, 480P, XGA, WXGA, SXGA and SXGA+ may not be automatically detected for optimal use.



* Depending on the model or input terminals, some signals may not be available and therefore, not displayed.

Code Setting for RGB

Normally, use this option in Auto mode.

White Screen

You can use this option to display white over the entire screen to minimize phosphor burn-in.



Each time you press  or , one of the available choices appears in the following sequence:

↔ Off ↔ On ↔

Press  to store.

Background

When the screen size was set to "Normal", to reduce "burn-in", the brightness of the part at which left and right images are not displayed can be set. Normally, we recommend that "Light Gray" be used.

Each time you press  or , the settings is switched.

↔ Black ↔ Dark Gray ↔ Light Gray ↔

Press  to store.

* Effective for plasma display.

* Burn-in can still occur if the Normal mode is shown for extended periods.

Note

- If the operation is not executed for about 60 seconds, the menu disappears.
- Depending on the model, or the types of signals, some of the functions may not be available.
- The adjustment range varies depending on the display signal. Adjust to a desired picture quality in the allowable adjustment range.
- Setting and adjustment may be disabled depending on the signal type.

Information

Displays system operation status.

Select "Information" and press .

The "Information" screen will appear.

[Mode]: The input mode or channel number is displayed

[Freq. Scan Mode]: Frequency scanning

[Input Signal]: Video mode

[Input Sync.]: Sync. Signal type

[Freq.]: Sync. Signal frequency, polarity

[Preset No.]: RGB code number

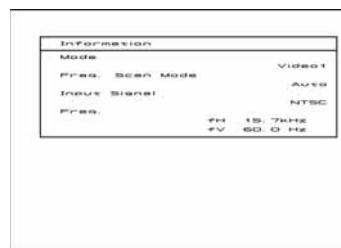

"Information" Screen (example of Video1 mode)

INITIALIZATION OF USER ADJUSTMENT VALUE

Using the MENU to restore the values of the factory settings after adjustments have been made.

1 Press **MENU**.

The main menu screen will appear.



2 Press **▲** or **▼** to select "Display Menu" and press **▶** or **ENTER**.

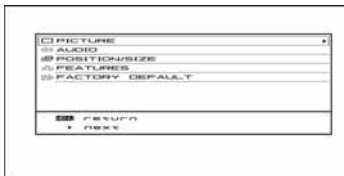

"Display Menu" selected in the main menu screen

3 Press **▲** or **▼** to select "FACTORY DEFAULT" and press **▶** or **ENTER**.

Each time you press **▲** or **▼**, one of the available menus appears in the following sequence:

PICTURE ↔ AUDIO ↔ POSITION/SIZE ↔ FEATURES ↔ FACTORY DEFAULT

The "FACTORY DEFAULT" menu screen will appear.



"FACTORY DEFAULT" selected in the main menu screen

4 Press **ENTER**.

5 Press **▲** or **▼** to select the "Yes".



Displays the message prompting you to proceed with the initialization.

- Displays the message prompting you to proceed with the initialization.

6 Press **ENTER**.



Displays the message of having completed the initialization

- The message of having completed the initialization will be displayed after initializing.

7 Press **MENU** or **EXIT** when you finish.

Note

- If the operation is not executed for about 60 seconds, the menu disappears.
- Depending on the model, or the types of signals, some of the functions may not be available.
- The adjustment range varies depending on the display signal. Adjust to a desired picture quality in the allowable adjustment range.
- Setting and adjustment may be disabled depending on the signal type.
- If a new setting is made for Tuner, CC Service, or Auto Lock, it cannot be changed back to the factory default again.

The tuner setting procedure is as follows:



"TV Menu" Screen

Press or to select a target item below.
 Channel Setting ↔ CableCARD ↔ Emergency Alert
 Press or to move on to the next step.

Channel Setting

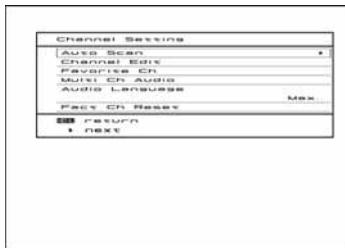

"Channel Setting" Screen

Press or to select a target item below.
 Auto Scan ↔ Channel Edit ↔ Favorite Ch ↔
 Multi Ch Audio ↔ Audio Language ↔ Fact Ch Reset
 Press or to move on to the next step.

Auto Scan

Scans the Antenna or Cable and automatically searches for a receivable channel and enters that channel in the channel listing.

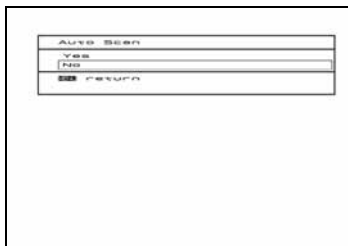

"Auto Scan" Screen

Use or to select Yes.
 When is pressed, Auto Scan starts. Auto Program MENU appears and Auto Scan is performed.
 * When Auto Scan is executed after selecting the "ANTENNA" input mode by pressing **ANTENNA**, only the signals from "ANTENNA" are auto scanned.
 * When Auto Scan is executed after selecting the "CABLE" input mode by pressing **CABLE**, only the signals from "CABLE" are auto scanned.

Channel Edit

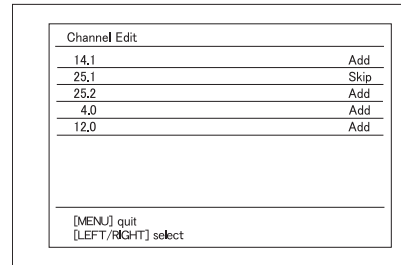

"Channel Edit" Screen

This function displays channels scanned by Auto Scan.

When or is operated, the function also determines whether to select the channel.

Press or to select a target channel.

Press or to switch between the items.

↔ Add ↔ Skip ↔

[Add]: Selects a channel.

[Skip]: Disables channel selection.

TV SETTING (TV MENU) (Continued)

Favorite Ch

Sets the channel which is displayed when **FAVORITE** was pressed.

Favorite Ch	
14.1	Add
25.1	Skip
25.2	Add
4.0	Add
12.0	Add

[MENU] quit
[LEFT/RIGHT] select

The channel listing registered by Auto Scan appears.

Press or to select the channel.

Press or to switch.

↔ Add ↔ Skip ↔

[Add]: Can be chosen with **FAVORITE**.

[Skip]: Cannot be chosen with **FAVORITE**.

Multi Ch Audio

This function selects an audio program available with the displayed channel.

Press or to select a target audio program.

Press to determine the audio program.

* The audio language output and the language displayed on the screen may differ from each other. The language displayed is dependent on the signal being received from the broadcast station and therefore does not indicate any problem with the display itself.

Audio Language

Switches the audio language.

Switch by pressing or .

↔ English ↔ Spanish ↔ French ↔

[English]: English audio is output.

[Spanish]: Spanish audio is output.

[French]: French audio is output.

Press to store.

* When the set audio is not in the broadcast, audio is output in another language.

Fact Ch Reset

This function resets the current channel list to the factory setting.

Press or to select "YES", and press .

CableCARD

This function displays information necessary for contacting your cable-TV provider.

• The information is not displayed unless the CableCARD is inserted.

Emergency Alert

When received the messages of Emergency Alert System (EAS), the display will automatically display them.

This function sets the display switching to the emergency alert broadcast.

Press or to switch among the items.

↔ Low ↔ Mid. ↔ High ↔ Max. ↔

[Low]: Switches to emergency broadcast whenever an emergency alert is put on the air.

[Mid.]: Switches to medium or higher priority emergency alert.

[High]: Switches to high or higher priority emergency alert.

[Max.]: Switches to maximum priority emergency alert.

Press to store.

* If you want to view the Emergency Alert messages at any time, please set "Emergency Alert" of on-screen display menu to "Low".

Note

- If the operation is not executed for about 60 seconds, the menu disappears.
- Depending on the model, or the types of signals, some of the functions may not be available.
- The adjustment range varies depending on the display signal. Adjust to a desired picture quality in the allowable adjustment range.
- Setting and adjustment may be disabled depending on the signal type.

IEEE1394 SETTING (IEEE1394 MENU)

STANDBY MODE SETTING

1 Press **MENU**.

The MENU screen is displayed.

Press or and select "IEEE1394", and then press or or **ENTER**.

The Standby Mode is switched each time or is pressed.

↔ On ↔ Off ↔

[On]: Devices connected by IEEE1394 cable can be linked even when this set's power is Off (Standby).

[Off]: When this set's power is Off (Standby), devices connected by IEEE1394 cable cannot be linked.

* Depending on the devices to be connected, they may be linked even when Standby Mode setting is Off.

IEEE1394 CONNECTION AND OPERATION EXAMPLES

The connected devices can be controlled from this product. (Control may be impossible, depending on the device.)

Connect each device to this product by IEEE1394 cable as shown in the figure below and perform the operations described below.

Press **Link 1394**.
Select each device, and press **ENTER**.

Connecting to STB and DTV

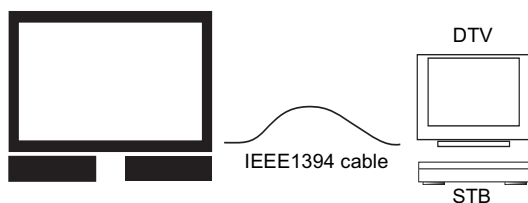

The signal from the STB or DTV is displayed as shown below.

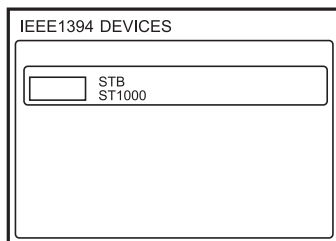

IEEE1394 device selection screen

Thereafter, follow the instructions displayed on the screen.

Connecting to AVHDD

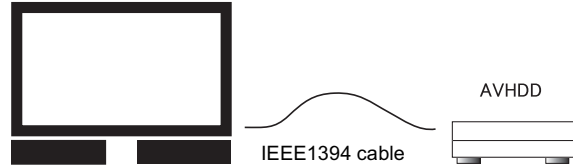

The signal from the AVHDD is displayed as shown below.

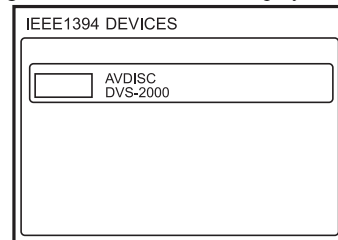

IEEE1394 device selection screen

Arbitrary operation is possible by operation screen.

The following is an example of the display when recording listing was selected and the **ENTER** was pressed.



Operation screen example

Each operation can be performed by choosing and executing the icons shown below. Depending on the device to be connected (external equipment), an icon may not be displayed or the device may be unusable even if an icon is displayed.

- Return
- Recording program listing
- Stop
- Play
- Pause
- Rewind
- Fast forward
- Rec Pause
- Rec Stop
- Erase
- Device menu
- Power on/off

The following is an example of the display when a program was chosen from the recording listing and the Play button was pressed.

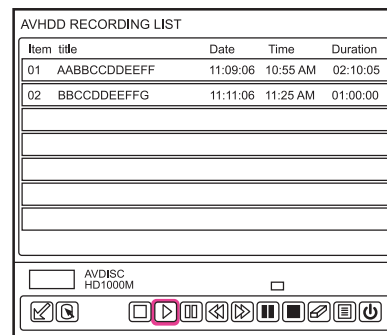

Operation screen example

IEEE1394 SETTING (IEEE1394 MENU) (Continued)

PRECAUTIONS RELATED TO CONNECTION OF IEEE1394 DEVICES

Only TV-GUIDE recording operation is effective.

There are devices which cannot be connected, depending on the IEEE1394 devices supported

- DVD recorder, personal computer, personal computer peripheral devices cannot be connected, because the specifications are different.
- Analog broadcasts cannot be recorded.
- Operation may be erroneous when a DVD recorder, PC peripheral devices, and other devices not supported by this product are connected at the same time.
- When used by connecting multiple IEEE1394 devices, operation may be unstable depending on the use and interconnection of the connected devices. In this case, operation may be stabilized by disconnecting unused devices or by changing the way the devices are connected.
- When too many devices are connected at the same time, unexpected operation may be performed depending on the compatibility, etc. between the interconnected devices.
- Do not connect in a loop.
Also IEEE1394 devices with 3 or more branches are not supported.

While using IEEE1394 devices, do not disconnect or connect the IEEE1394 cord of the connected IEEE1394 devices. Also, while using this product, do not perform IEEE1394 device power on/off and other operations. The picture and sound may be disturbed.

- Some IEEE1394 device cannot relay data when the power of the device is turned off. In this case, turn on the power of the device and then connect.
- Only MPEG2 TS and DV are supported. The picture of contents recorded with other than this product may be disturbed.
- * When this product does not operate normally, reuse it after turning off the power once.

Example of usable connection

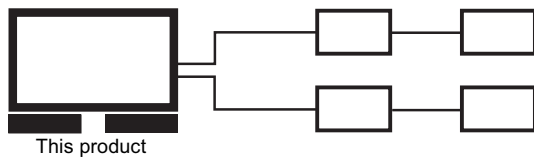

Example of unusable connection (because it is a loop connection)

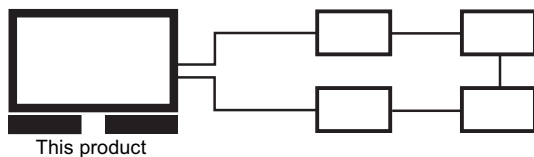

Example of unusable connection (because there are 3 branch connections)

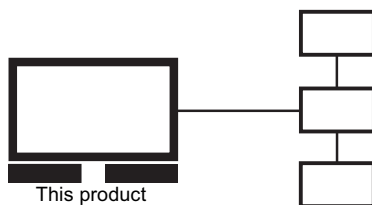

Note

- If the operation is not executed for about 60 seconds, the menu disappears.
- Depending on the model, or the types of signals, some of the functions may not be available.

INITIALIZING TV GUIDE ON SCREEN™ SYSTEM

- Initialize TV Guide On Screen system.
- Perform initialization in accordance with the TV set on-screen menu.
- When you use the "TV Guide On Screen" function for the first time, a TV Guide On Screen system Welcome screen will appear.
- Perform setup to offer TV program listing and channel lineup for the area where you live.

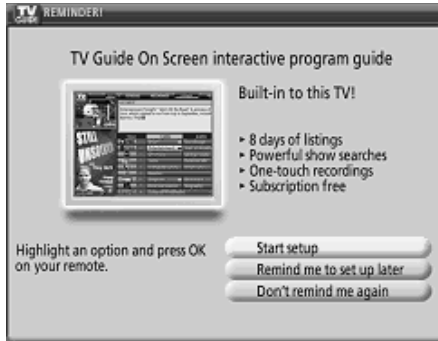

Reminder screen



Welcome screen

When is pressed, the process advances to the first setup process.

To navigate in the Guide setup screens

- Press , , , to highlight selections
- Press to select the highlight options.
- Press to display available Help information.

Identifying Your Location

1 Select your Country.

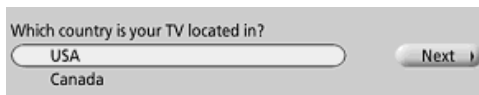

When , is used to select the country and is pressed, a check mark appears next to the selected country. Use to highlight "Next" and press .

2 Enter ZIP or Postal Code.

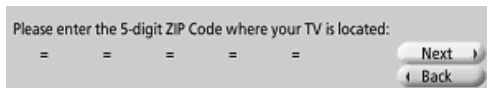

The above screen is for USA.

Set the ZIP Code or Postal Code of your area by pressing the number keys. Use to highlight "Next" and press .

Selecting Your Broadcast Services

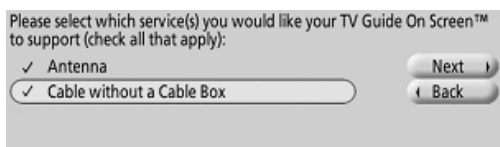

When , is used to choose video source(s) services and is pressed, a check mark appears next to the selected video source. Press to highlight "Next" and press .

Note

Cable Box and Satellite setups are not supported.

INITIALIZING TV GUIDE ON SCREEN™ SYSTEM (Continued)

Checking Setup

After you have configured all services you selected in Step 2 you are asked to check your settings.

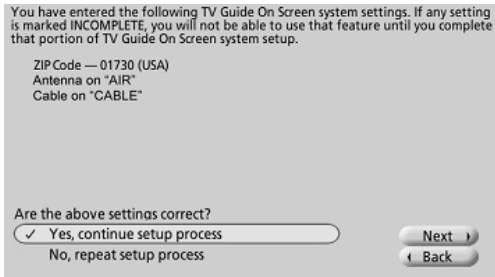

If you select Yes, continue setup process, go to Step 4.

If you select No, repeat setup process, return to Step 1.

Complete Setup

The Helpful Information screen appears when you successfully complete Guide setup.

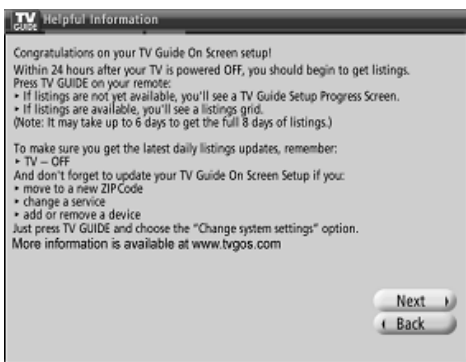

View Setup Progress Screen

The setup progress screen appears each time you enter the Guide prior to receiving your initial eight days of show listings. To close the screen press **ENTER**.



Note

In order to begin to receive your listings, power off the TV when not in use. Within 24 hours, you will begin to receive TV show listings. It may take up to six days to receive the full eight days of initial show listings.

About the TV Guide On Screen System

TV Guide On Screen system offers up to 8 days of television shows. Television shows can be easily viewed and recorded by using TV Guide On Screen system.

The TV Guide On Screen System has the following 5 main services:

- **LISTINGS** : Displays show listings.
When a title in a show listing is chosen, information for that show is displayed.
Shows with titles in the show listings can be viewed.
Recording and reminder scheduling of shows are possible.
- **SEARCH** : Shows you want to view can be searched by keyword, category, or alphabetically by title.
- **RECORDINGS** : Displays a list of previously recorded or currently recording shows.
- **SCHEDULE** : Lets you review, edit, or delete scheduled recordings and reminders.
- **SETUP** : System setup, channel display, and default option can be reviewed and modified.

Common precautions

- ① Initialize TV Guide On Screen system before use.
- ② Program video is not displayed if the cable or the antenna is not connected.
- ③ If a broadcast does not contain TV Guide On Screen information, TV Guide On Screen information cannot be acquired. Also, it may take several days to search 8 days worth of show information.
- ④ TV Guide On Screen system supports cable television and VHF/UHF television, but does not support satellite broadcasts.
- ⑤ If not actually aired, a show cannot be viewed even if its name is listed in TV Guide On Screen system.
- ⑥ "RECORDINGS" can be used by connecting your product to a recording device having IEEE1394 functions.
(There are also some devices which do not operate even if connected.)
- ⑦ The pictures in this document are typical. The broadcast stations and shows are different, depending on the reception area.



Remote Control Functions of the TV Guide On Screen system

- GUIDE** : Displays or exits TV Guide On Screen.
- CH INFO** : Displays program information and HELP.
- CHPAGE**, **CHPAGE** : Scrolls the page.
- MENU** : Displays various panel menus.
- ENTER**, **ENTER**, **ENTER** : Select shows and functions.
- ENTER** : Executes the selected item(s).

USING TV GUIDE ON SCREEN™ SYSTEM (Continued)

Basic Operation

When **[GUIDE]** is pressed while watching TV, the TV Guide On Screen "LISTINGS" screen appears.

(When **[GUIDE]** is pressed while watching picture through IEEE1394 input, the TV Guide On Screen "LISTINGS" screen appears, too.)

When **[CH INFO]** is pressed when the Info icon is displayed, programs, services, or HELP Information is displayed in an Info Box.















Performing operations while viewing the information displayed in the Info Box is convenient.



LISTINGS SCREEN

FEATURE	Description
Video Window	Displays TV video while the Guide is displayed (can be locked on a single channel or unlocked to preview channels as you navigate "LISTINGS" and Channel Editor)
Lock/Unlock Icon	Indicates the status of the Video Window
Clock	Displays the current local time
Service Bar	Provides access to the main Guide Services
Current Services Label	Indented to identify the current Service screen
Info Box	Provides information for a highlighted item
Info Icon	Indicates you can press [CH INFO] to cycle through the various Info Box sizes or view Help text for a Service
Info Bar	Displays show-specific broadcast information, such as new episode, TV or Movie rating, and show progress indicator
Ad	Location where show- or product-specific information appears
(Menu)	Location where on-screen menus appear
Channel Logo & Number	Identifies network and channel number
Title Tile	Displays show title.
Highlight	Indicates an active tile, from which you can set recording, set reminder, display a menu, etc.
Record & Remind Icon	Indicates you set a recording or reminder event for the show
HD Icon	Identifies shows that are broadcast in HDTV

TV Guide On Screen Icons (Examples)

Icon	Description
	Closed captioning is available
	Identifies shows that are broadcast in HDTV
	Program is available in stereo
	Program is new
	TV Rating for the program (example)
	Records the show one time
	Records the show if the show title appears on any day of the week on the same channel at a similar start time
	Records the show if the show title appears on a specific day of the week on the same channel at a similar start time
	Records on the specified channel and time every Monday through Friday
	Keeps the recording in "TO DO" but does not record until you reset the frequency
	Reminds you once for a specific show episode
	Reminds you if the show title appears on any day of the week on the same channel at a similar start time
	Reminds you if the show title appears on a specific day of the week on the same channel at a similar start time
	Reminds you for the specified channel and time every Monday through Friday
	Keeps the reminder in "TO DO" but does not remind until you reset the frequency

USING TV GUIDE ON SCREEN™ SYSTEM (Continued)

LISTINGS

1 When **GUIDE** is pressed while watching TV, the TV Guide On Screen "LISTINGS" screen appears.

2 Use , , ,  to select the desired title tile (show title) in the program listing.

- To view the selected show

Press .

- To view the contents of the selected show and the information for programs which will air later

Press **CH INFO**.





- To set recording and reminder selected shows, or edit, and delete the scheduled show

Press **MENU**. The "Episode Options" menu appears on the left side of the screen. Setting, editing, and deletion are performed from within this menu.





Use ,  to choose the item in the "Episode Options" menu you want to execute, and press .

Episode Options items

Item	Contents
go to Service Bar	Highlights "LISTINGS" on the "Service Bar".
watch now /tune to channel	Displays the channel being aired or a channel scheduled to be aired.
set recording	When each "Record Options" item is set and  is pressed, "schedule recording" is highlighted. Recording of shows can be scheduled by pressing  again.
set reminder	When each "Remind Options" item is set and  is pressed, "schedule reminder" is highlighted. Reminder of shows can be scheduled by pressing  again.
delete recording	Cancels scheduled recording shows. (Displayed only when a scheduled recording show was chosen.)
edit recording	Edits each item of a scheduled recording show. (Displayed only when a scheduled recording show was chosen.)
delete reminder	Cancels scheduled reminder shows. (Displayed only when scheduled reminder show was chosen.)
edit reminder	Edits each item of a scheduled reminder show. (Displayed only when a scheduled reminder show was chosen.)
Cancel	Cancels the "Episode Options" menu.

INFORMATION

An ALERT screen is displayed before a scheduled Recording or Reminder program is started. (Default: 1 minute before) When schedules overlap, use ,  to choose the program you want to watch and press .



Setting Listings Options

When LISTINGS is highlighted and  is pressed, the Listings Options screen appears on the left side of the screen. The video, channel ID or edit channel function can be performed.



video window : "locked"  - video remains on a single channel



"unlocked"  - video changes channels as you navigate the grid

When  is pressed after setting, "done" is highlighted. When  is pressed again, setting is finished.

channel ID : "both" - both channel logo and number are displayed in the grid

"logo" - only channel logo is displayed in the grid

"number" - only channel number is displayed in the grid

When  is pressed after setting, "done" is highlighted. When  is pressed again, setting is finished.

edit channels : Sets "Change channel display" of the "SETUP". Change the program service that the TV Guide On Screen uses for any channel. Edit the channels that appear in the TV Guide On Screen, reorder their position in the grid, change their tune channel, and, if you have more than one program service, specify the service and input for each channel. You can modify settings directly in the Channel Editor screen.



Shortcuts



In "LISTINGS", use the number keys on your remote control to

- Enter the number of the channel you want to view, or
- Enter the number of hours (or days) you want to jump ahead or back

The **Shortcuts** menu appears.



Press  or  to highlight the command you want and press , or

- If you entered a channel number, press  when the menu appears to jump directly to the channel row.
- If you entered a specific number of hours, press  (hours ahead) or  (hours back) when the menu appears to jump directly to that time slot.

USING TV GUIDE ON SCREEN™ SYSTEM (Continued)

SEARCH

The name of the shows you want to watch can be searched by category, keyword, or alphabetically by title.

Searching by category

- 1** When **GUIDE** is pressed while watching TV, the TV Guide On Screen "LISTINGS" screen appears. Press **←**, **→**, **↑** to highlight "SEARCH" on the Service Bar.
- 2** Use **←**, **→**, **↑**, **↓** to choose the desired Category ("MOVIES", "SPORTS", "CHILDREN")



















- 3** Use **←**, **→**, **↑**, **↓** to choose Sub Category, and press **ENTER**. A show listing appears.























- 4** When a show is selected using **←**, **→** and **MENU** is pressed, the "Episode Options" screen appears and the following can be performed:

Item	Contents
go to Service Bar	Selects "SEARCH" on the Service Bar.
watch now / tune to channel	Displays the channel being aired or a channel scheduled to be aired.
set recording	Program recording can be scheduled.
set reminder	Program reminder can be scheduled.
cancel	Cancels the "Episodes Options" menu.





Searching alphabetically by title

- 1** When **GUIDE** is pressed while watching TV, the TV Guide On Screen "LISTINGS" screen appears. Press , ,  to highlight "SEARCH" on the "Service Bar".
- 2** Use , , ,  to choose "ALPHABETICAL" from the Category Bar.
- 3** Use , , ,  to choose the first letter of the program you want and press . A show category listing appears.
- 4** Use ,  to choose the category from the desired program category listing and press . A show listing appears.
- 5** When a show is selected using ,  and **MENU** is pressed, the "Episode Options" screen appears and the following can be performed.

Searching by keyword

- 1** When **GUIDE** is selected while watching TV, the TV Guide On Screen "LISTINGS" screen appears. Use , ,  to highlight "SEARCH" on the Service Bar.
- 2** When ,  is used to highlight "KEYWORD" and **MENU** is pressed, the "Keyword Options" menu appears.
- 3** When ,  is pressed to choose "new search" and  is pressed, the "Search Option" menu appears.
- 4** After using , , ,  to choose each item and "enter keyword" is chosen, press . A keyboard appears.
- 5** After using , , ,  to choose the keyword and "DONE" is chosen, press . A show category listing appears.
- 6** When the category you want to watch is chosen from the program category listing and  is pressed, a show listing appears.
- 7** When the show you want to schedule for recording or reminder is chosen from the show listing and  or **MENU** is pressed, the "Episode Options" menu appears and a recording and reminder schedule can be set.

Edit search







- 1** Highlight "SEARCH" and press , ,  to highlight "KEYWORD".
- 2** Press  to highlight a saved keyword tile, and press **MENU**.
- 3** "Search Options" menu appears.
 "edit search" ----- Keyword can be changed and edited.
 "delete search" ----- Entered keyword can be deleted.

USING TV GUIDE ON SCREEN™ SYSTEM (Continued)



SCHEDULE



With "SCHEDULE" Service scheduled recording and reminder shows can be reviewed, edited, and deleted. Manual recording and reminder scheduling are also possible.

TO DO







- 1** Press **GUIDE** when watching the TV. Press , , ,  to highlight "SCHEDULE" on the "Service Bar".
- 2** When "TO DO" is highlighted by using , , a set recording or reminder show listing appears.
 - When **GUIDE** is pressed, a "Schedule Options" menu appears on the left side of the screen. The following operations can be performed at the "Schedule Options" menu.



Item	Contents
go to Service Bar	Selects "SCHEDULE" on the "Service Bar".
sort by	The scheduled show display can be switched.
new manual recording	Recording can be set manually by setting the recording date, time, channel and other settings and pressing  .
new manual reminder	Reminder can be set manually by setting the reminding date, time, channel, and other settings and pressing  .
cancel	Clears the "Episode Options" menu.

- When ,  is used to choose a show from a show listing and **MENU** is pressed, the "Schedule Options" menu appears. Set recording and reminder shows can be reviewed, edited, and deleted.

HISTORY

- 1** Press **GUIDE** when watching the TV. Press , ,  to choose "SCHEDULE" on the Service Bar.
- 2** When "HISTORY" is chosen using , , , , a currently recording or previously recorded show listing is displayed.

Note : Resolving Conflicts

A conflict message appears when a show you schedule to

- Record overlaps with any part of another show previously set to record
- Record overlaps with a reminder previously set to auto tune
- Remind and auto tune overlaps another auto-tune reminder
- Remind and auto tune overlaps with a scheduled recording

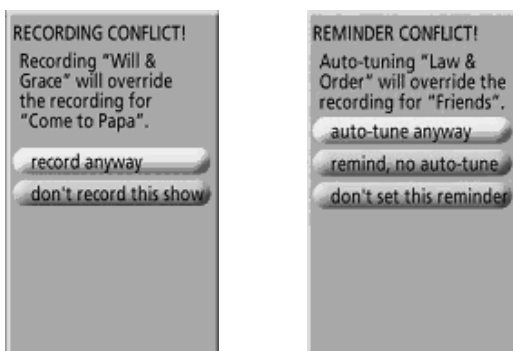



To resolve the conflict, you must select one of these options (which vary according to the type of conflict):

- **record anyway** - records the specified show and suspends the existing show recording or auto-tune reminder
- **don't record this show** - cancels the specified show recording
- **auto-tune anyway** - auto tunes the specified show and suspends the existing show reminder set to auto tune
- **remind, no auto-tune** - schedules the specified show reminder but cancels the auto-tune option
- **don't set this reminder** - cancels the specified reminder

USING TV GUIDE ON SCREEN™ SYSTEM (Continued)

RECORDINGS

1 Press **GUIDE** when watching the TV. Press , ,  to highlight "RECORDINGS" on the "Service Bar".

- To choose the way recordings are displayed
When **MENU** is pressed, "Recordings Options" appears and the "View As" and "Sort By" functions can be used.
 - To view a recording
When ,  is used to select a show from the show listing and **MENU** is pressed, "Episode Options" appears. "Resume" and "play back beginning" functions can be used.
- * Effective when connected to a recording device by IEEE1394 interface. (For more information, see P. E-43 "IEEE1394 SETTING".)

SETUP

Change system settings:

You can modify any information you entered during initial Guide setup at any time. This is useful if you want to change your connected broadcast service or move your TV to a new ZIP or POSTAL Code.

Change channel display:



You can edit the channels that appear in the Guide, reorder their position in the grid, change their tune channel, and, if you have more than one broadcast service, specify the service and input for each channel. You can modify settings directly in the Channel Editor screen, or you can use the Grid Options menu. Your settings determine how the channel is displayed in "LISTINGS" and "SEARCH".

Change default options:

You can change the initial settings of TV Guide On Screen system. ("General defaults", "Record defaults", and "Remind defaults")

Display setup progress:

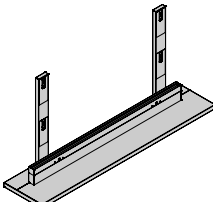
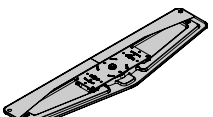
View the setup progress screen

Desktop Stand unit	P-TT6500 (for 65" model)	
Swivel (Revolving stand)	P-TT3700 (for 37" model)	
Speaker (1 set of 2 speakers)	P-SP2000 (for attaching to the display) for 65" model * The speakers can be also used mounting on the optional "Desktop Stand unit (P-TT6500 type)".	

Warning

To prevent injury, fire, and electric shock, we recommend that the display be professionally installed.

CAUTION

This display (P37FT05AUB) is for use only with Fujitsu General Limited's option (P-TT3700).
 This display (P65FT00AUB) is for use only with Fujitsu General Limited's options (P-TT6500).
 Using this display with other option can cause instability resulting in possible injury.

Note

- When mounting the display newly, it is important to ensure that all installation requirements for that mounting option are met. Refer to the corresponding Installation Manual.
- Please note that the color of options are not matched the color of display perfectly.
- To improve the function and performance of optional accessories, the specifications and part names of the optional accessories may change. Consult your local dealer before purchasing.

MAIN SUPPORTED SIGNALS

The display can store up to four types of signals for RGB adjustment values. The display uses the first-in, first-out method; therefore, the first input signal is cleared when the fifth one is input. Input the signal you want to store and adjust to a desired screen according to "ADJUSTING SCREEN POSITION AND SIZE". When the adjustment has been made, it is automatically stored. Thus, when the display receives the same signal later, pictures will be displayed in accordance with the adjustment value most recently stored.

RGB1 INPUT

Display (dots x lines)	Horizontal frequency (kHz)	Vertical frequency (Hz)	Signal
640 x 480	31.47	59.94	VGA
640 x 480	37.50	75.00	VGA 75 Hz
640 x 480	43.27	85.01	VGA 85 Hz
720 x 400	31.47	70.09	400 lines
800 x 600	37.88	60.32	SVGA 60 Hz
800 x 600	46.88	75.00	SVGA 75 Hz
800 x 600	53.67	85.06	SVGA 85 Hz
1024 x 768	48.36	60.00	XGA 60 Hz
1024 x 768	60.02	75.03	XGA 75 Hz
1024 x 768	68.68	84.99	XGA 85 Hz
1280 x 1024	63.98	60.02	SXGA 60 Hz
1280 x 1024	79.98	75.03	SXGA 75 Hz
848 x 480	31.02	60.00	
852 x 480	31.72	59.97	
1360 x 768	47.71	60.01	
720 x 485	15.73	59.94	60 fields

- With some input signals, "Out of range" may appear or the image may appear in black and white when the horizontal and vertical frequencies are outside their permissible ranges, or even when the frequencies are within their permissible ranges. In this case, match the input signal to a different frequency in the above table.

In the Component Video, HDMI and Video/S-video, the display has been factory-set as follows for different input signals:

Main corresponding signals (Comp.video, HDMI mode)

Horizontal frequency (kHz)	Vertical frequency (Hz)	Signal	Comp. Video	HDMI
15.73	59.94	480i (SD signal)	○	○
31.47	59.94	480p (SD signal)	○	○
45.00	60.00	720p (HD signal)	○	○
33.75	60.00	1080i (HD signal)	○	○
67.50	60.00	1080p (HD signal)	-	○

VIDEO1,2 INPUT (Video , S-Video mode)

Horizontal frequency (kHz)	Vertical frequency (Hz)	Signal
15.73	59.94	NTSC

RF INPUT

ANTENNA : NTSC and ATSC

CABLE : NTSC, 64QAM and 256QAM

Note

- Depending on the input signal, the display may show pictures of reduced size due to size reduction and interpolation.
- You can check input signals through "Information" on the FEATURES Menu screen. (See P. E-39)
- All terms (i.e., company and product names) used in this document are trademarks or registered trademarks.

Precautions

Be sure to remove the power plug from the receptacle before cleaning the display.

Be sure not to clean the display using a cloth dampened with volatile solvents, such as benzene or thinner. Such solvents can harm the display's cabinet, the filter at the screen front, and the remote control. They can also cause paint to come off these sections.

Cleaning the Screen

Clean the screen gently with a soft cloth.

The screen surface is fragile. Never attempt to clean it with a hard material, press on it forcefully, or tap it.

Cleaning the Cabinet

Wipe off the dust on the surface of the cabinet gently with a clean dry soft cloth such as gauze or flannel.

Do not apply too much pressure to the cloth when wiping off the dust on the cabinet to prevent scratches on the cabinet caused by dust.

If the cabinet is extremely dirty, use a clean soft cloth from which the excess water has been removed after being soaked in a kitchen cleaner diluted with water. Finish cleaning by wiping the cabinet with a clean dry soft cloth.

To prevent fingerprints, etc. on the cabinet, do not hold the cabinet with your bare hands.

Cleaning the Remote Control

Use a soft cloth for cleaning.

If the remote control is heavily stained, soak a soft cloth in a mixture of water and detergent and squeeze it dry before wiping off the stains.

Use a soft, dry cloth for final cleaning.

Cleaning the ventilation grille

Remove dust from the ventilation grille in the rear of the main unit periodically with a vacuum cleaner as the accumulated dust can increase the internal temperature of the main unit causing machine failure or fire hazard.

MAINTENANCE

If you encounter problems with the display, check the following explanations before contacting your dealer for service.

Problem	Action
<ul style="list-style-type: none"> • Power does not turn ON. 	<ul style="list-style-type: none"> • Check whether the power plug is securely inserted into the receptacle.
<ul style="list-style-type: none"> • No pictures are displayed. 	<ul style="list-style-type: none"> • Check cables for disconnection. • Check whether the power for all input equipment is ON. • Check for connection to wrong terminals or for wrong input mode. • Check whether the input mode display is colored pink. Special setup may have been made. Return to original setup or initialize the User adjustment value.
<ul style="list-style-type: none"> • Remote control does not function properly. 	<ul style="list-style-type: none"> • Check for incorrect battery orientation. • Check for dead batteries. • Check for distance from the display. • Check whether you are pointing the remote control transmitter properly at the display's receiver. • Check for any obstacle between the remote control and the display.
<ul style="list-style-type: none"> • The display makes a snapping sound. 	<ul style="list-style-type: none"> • This sound is produced when the cabinet expands or contracts due to variations in temperature. This sound does not indicate that the display has a problem.
<ul style="list-style-type: none"> • The display makes a buzzing sound. 	<ul style="list-style-type: none"> • The display has fans to maintain the temperature of internal components at a constant level. This sound is produced by the fan as it rotates. (Applies to models equipped with a fan.)
<ul style="list-style-type: none"> • There are spots on the screen. 	<ul style="list-style-type: none"> • Check whether your AV equipment is affected by interference from automobiles, trains, high-voltage transmission lines, neon signs or other potential sources of interference.
<ul style="list-style-type: none"> • Degraded colors/tints 	<ul style="list-style-type: none"> • Check whether all picture adjustments have been properly made. (See "ADJUSTING TO A DESIRED PICTURE" on P. E-26–E-30.)
<ul style="list-style-type: none"> • Improper screen position/size 	<ul style="list-style-type: none"> • Check whether screen position and size have been properly adjusted. (See "ADJUSTING SCREEN POSITION AND SIZE" on P. E-32.)
<ul style="list-style-type: none"> • No audio 	<ul style="list-style-type: none"> • Check cables for disconnection. • Check whether the proper audio input has been selected. (See "Audio Input" on P. E-38.)
<ul style="list-style-type: none"> • If "Out of range" appears, the display is receiving a signal whose picture or signal cannot be reproduced by the display. • The screen turns to black and white. 	<ul style="list-style-type: none"> • Signals that are not supported by this display have been input. Check which signals are supported. (See "MAIN SUPPORTED SIGNALS" on page E-58.)
<ul style="list-style-type: none"> • If "Error message Condition 1" appears, the fan is defective. 	<ul style="list-style-type: none"> • Remove the power cord from the receptacle, and contact your dealer for repairs. (Applies to models equipped with a fan.)
<ul style="list-style-type: none"> • If "Error message Condition 2" appears, the display's internal components are extremely hot. 	<ul style="list-style-type: none"> • Remove the power cord from the receptacle. (You can turn the power back ON again when the components have cooled sufficiently.) If the message appears again when you turn the power back on, remove the power cord from the receptacle, and contact your dealer for repairs.
<ul style="list-style-type: none"> • If "Change refresh rate to 60Hz" appears, 	<ul style="list-style-type: none"> • The picture may get blurred with vertical frequency of other than 48.3-51.8 or 58.4-61.4 (Hz). Change the setting of your PC, etc.
<ul style="list-style-type: none"> • If the power indicator lamp flashes red or green. 	<ul style="list-style-type: none"> • Remove the power cord from the receptacle, and inform contact your dealer, referencing the flashing pattern experienced. • The power indicator lamp flashes differently depending on the type of problem.

SPECIFICATIONS

WIDE DISPLAY

Model	P37FT05AUB	P65FT00AUB
Type	Liquid crystal display panel	Plasma display panel
Screen size	37" wide screen: 81.9 cm (W) x 46.1 cm (H) (94.0 cm diagonal) 32.3 inch (W) x 18.2 inch (H) (37 inch diagonal)	65" wide screen: 143.4 cm (W) x 80.7 cm (H) (164.6 cm diagonal) 56.5 inch (W) x 31.8 inch (H) (65 inch diagonal)
Aspect ratio	16:9 (wide)	
Number of pixels	1920 (H) x 1080 (V)	
Weight	34 kg / 75.0 lbs	76 kg / 167.6 lbs
Outer dimensions	91.4 (W) x 66.5 (H) x 23.0 (D) cm 36.0 (W) x 26.2 (H) x 9.1 (D) inch (does not include outer projections)	159.2 (W) x 97.0 (H) x 10.0 (D) cm 62.7 (W) x 38.2 (H) x 4.0 (D) inch (does not include outer projections)
Power supply	AC120V 50/60 Hz	
External equipment terminals	RF INPUT CABLE ANTENNA TV 75 Ω: CATV 1-135 TV 75 Ω: UHF/VHF 2-69 VIDEO1 INPUT (Video input) RCA terminal 1.0 Vp-p/75 Ω VIDEO2 INPUT (S-video input) S terminal Y: 1 Vp-p/75 Ω C: 0.286 Vp-p/75 Ω VIDEO3/VIDEO4 INPUT 3 RCA terminals Y: 1 Vp-p/75 Ω (Component video input) Pb/Cb: 0.7 Vp-p/75 Ω Pr/Cr: 0.7 Vp-p/75 Ω VIDEO5/VIDEO6 INPUT HDMI terminal (HDMI type A connector) RGB1 INPUT mD-Sub, 3 rows, 15-pin Picture signal: 0.7 Vp-p/75 Ω Synchronization signal: TTL level IEEE1394 INPUT/OUTPUT IEEE1394-1995 6-pin (2 lines) AUDIO1-3 INPUT 2 audio input pin jacks (L/R) (3 lines) / 0.5 Vrms AUDIO OUTPUT ANALOG 2 audio input pin jacks (L/R) (1 line) / 0.5 Vrms AUDIO OUTPUT DIGITAL Optical audio terminal (PCM / Dolby Digital) RS-232C D-Sub 9-pin	
External speaker output terminal	—	Max. output: 12 W + 12 W, 4 Ω
Speakers	∅7 cm woofer x2(L/R) ∅2.5 cm tweeter x1(L/R) Max. output: 12 W + 12 W (L + R)	—
On-screen display language	English, Spanish, or French	
Operating conditions	Temperature: 0 to 40 °C / 32 to 104 °F Humidity: 20 to 80 %	
Accessories	2 user's manuals, 1 remote control, 2 AA batteries, 1 power cord, 5 large ferrite cores, 2 small ferrite cores	

Regulation

- UL, CSA Safety: UL60065, C-UL
EMC: FCC Part15, ICES-003 (CISPR22)
FCC Part76 Sec.76.605(12)

Note

- Specifications and external appearance are subject to change without notification for the sake improvement.
- Viewing the screen constantly for extended periods can strain your eyes. Be sure to stay at a proper distance (at least 1.4 m or 4.6 feet for 37"/ at least 2.5 m or 8.2 feet for 65") from the screen, occasionally looking away from the screen during extended watching screen.
- AVIAMO is a worldwide trademark of FUJITSU GENERAL LIMITED.