



Westinghouse

# **USER'S MANUAL**

*MANUEL DE L'UTILISATEUR*

*MANUAL DEL USUARIO*

---

**VM-42F140S**

**VM-47F140S**

1080p Monitor

*Moniteur 1080p*

# TABLE OF CONTENTS

<b>1. IMPORTANT SAFETY AND PRECAUTIONS.....</b>	<b>1</b>
1.1 Important Information.....	1
1.2 Important Safety Instructions.....	2
<b>2. GENERAL INFORMATION.....</b>	<b>4</b>
2.1 Overview.....	4
2.2 Feature.....	7
2.3 Controls and Ports of the Monitor.....	9
2.4 Accessories.....	12
2.5 Remote Control.....	13
<b>3. INSTALLATION &amp; FUNCTION ADJUSTMENT.....</b>	<b>15</b>
3.1 Installation.....	15
3.2 How to assemble the Base.....	17
3.3 How to remove the Base.....	18
3.4 Function Adjustment.....	19
<b>4 TROUBLESHOOTING.....</b>	<b>25</b>
<b>5 PRODUCT SPECIFICATION.....</b>	<b>28</b>



# 1. IMPORTANT SAFETY AND PRECAUTIONS

This wide active matrix TFT (thin film transistor) liquid crystal monitor is designed for use as a stand alone MONITOR as well as a display device for video electronics appliances and personal computers.

## 1.1. Important Information

Warning : To reduce the risk of fire or electric shock, do not expose this product to rain or moisture.

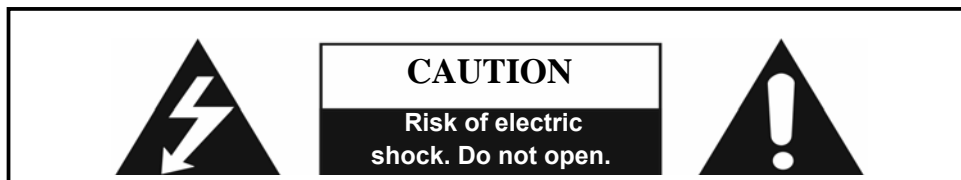

The symbol is intended to alert the user to presence of un-insulated "Hazardous Voltage" within the product's enclosure that may be of sufficient magnitude to constitute a risk of electric shock to persons.



The symbol is intended to alert the user that improper use of the product may result in product malfunction. The user should pay attention to avoid accidents or unnecessary problems.

Caution : To reduce the risk of electric shock, do not attempt to disassemble or modify this device. There are no user-serviceable parts inside. Refer any service issues to qualified service personnel.

Caution : FCC/ CSA regulations state that any unauthorized changes or modifications to this equipment may void the user's authority to operate it.

Important: One Federal Court has held that unauthorized recording of copyrighted MONITOR programs is an infringement of U.S. copyright laws. Certain Canadian programs may also be copyrighted and any unauthorized recording in whole or in part may be in violation of these rights.

Warning : Do not leave stationary images, patterns, PIP windows, or letterbox images on the screen for prolonged periods of time as this may result in permanent damage to the LCD panel. This type of damage is not covered under warranty. The following are examples of, but not limited to, potentially hazardous display output: side bar images, video game patterns, closed captioning, channel logos and letterbox black bars. To prevent this type of damage, it is recommended to display constantly moving images that fill the screen as often as possible.

According to industrial standards for LCD display technology; there are a certain number of allowable defective pixels. Although we produce panels with more than 99.9% active cells, there still may be some cells that do not produce light or remain constantly lit. For further information, please contact sales or technical support.

## **1.2 Important safety instructions**

1. Read these instructions.
2. Keep these instructions.
3. Heed all warnings.
4. Follow all instructions.
5. Do not use this apparatus near water.
6. Clean only with dry cloth.
7. Do not block any ventilation openings. Install in accordance with the manufacturer's instructions.
8. Do not install near any heat sources such as radiators, heat registers, stoves, or other apparatus (including amplifiers) that produce heat.
9. Do not defeat the safety purpose of the polarized or grounding-type plug. A polarized plug has two blades with one wider than the other. A grounding type plug has two blades and a third grounding prong. The wide blade or the third prong are provided for your safety. If the provided plug does not fit into your outlet, consult an electrician for replacement of the obsolete outlet.
10. Protect the power cord from being walked on or pinched particularly at plugs, convenience receptacles, and the point where they exit from the apparatus.
11. Only use attachments/accessories specified by the manufacturer.
12. Use only with the cart, stand, tripod, bracket, or table specified by the manufacturer, or sold with the apparatus. When a cart is used, use caution when moving the cart/apparatus combination to avoid injury from tip-over.



13. Unplug this apparatus during lightning storms or when unused for long periods of time.
14. Refer all servicing to qualified service personnel. Servicing is required when the apparatus has been damaged in any way, such as power-supply cord or plug is damaged, liquid has been spilled or objects have fallen into the apparatus, the apparatus has been exposed to rain or moisture, does not operate normally, or has been dropped.

English

Español

Français

## 2. GENERAL INFORMATION

### 2.1 Overview

#### A. Front View of the HD Video Monitor

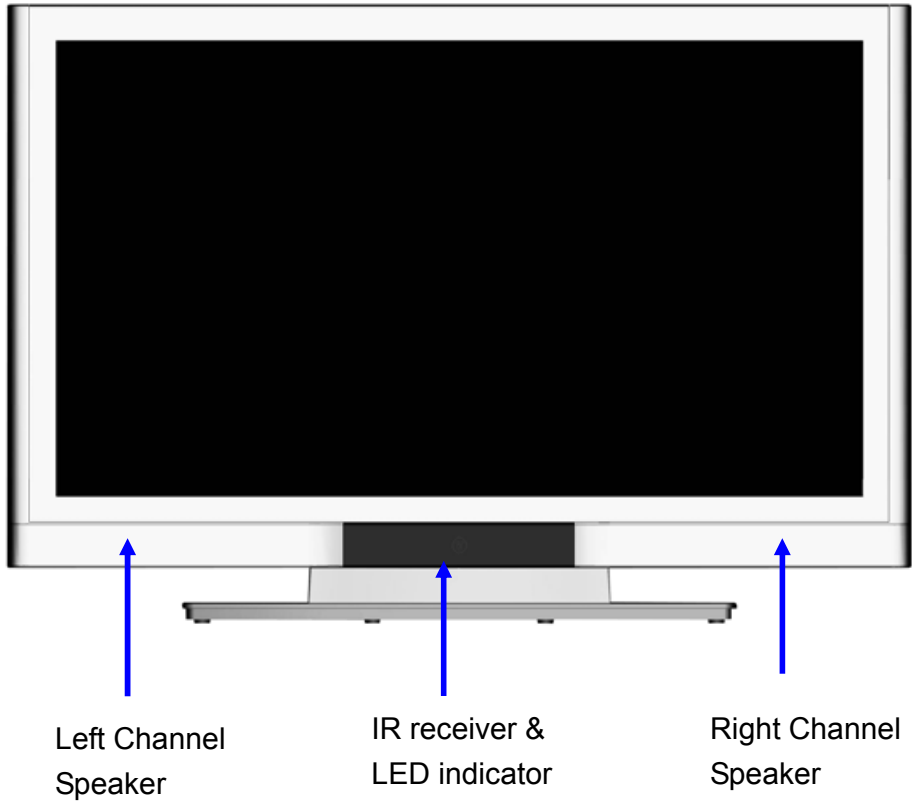

**B. Rear View of the HD Video Monitor**

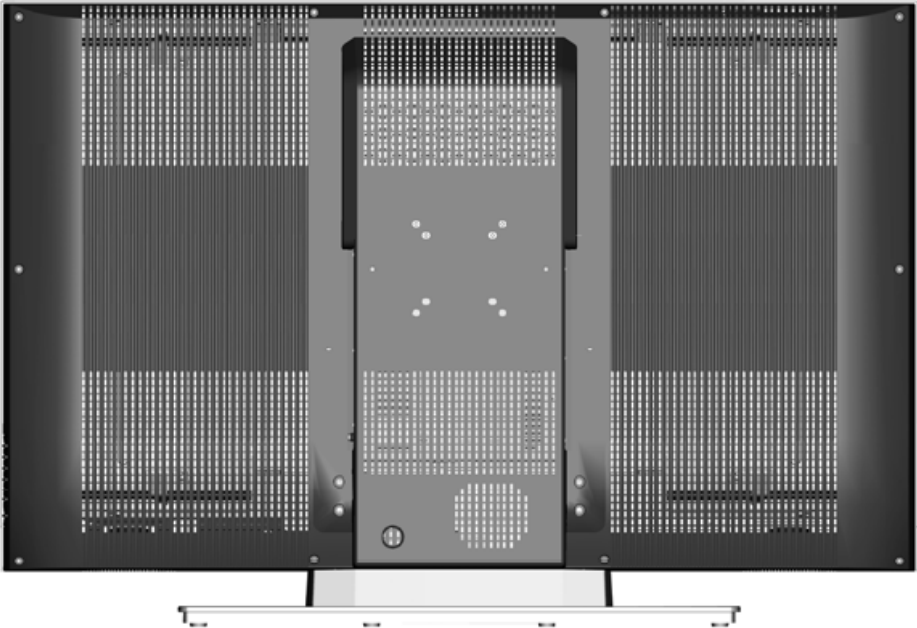

English

Español

Français



### C. Side View of the HD Video Monitor

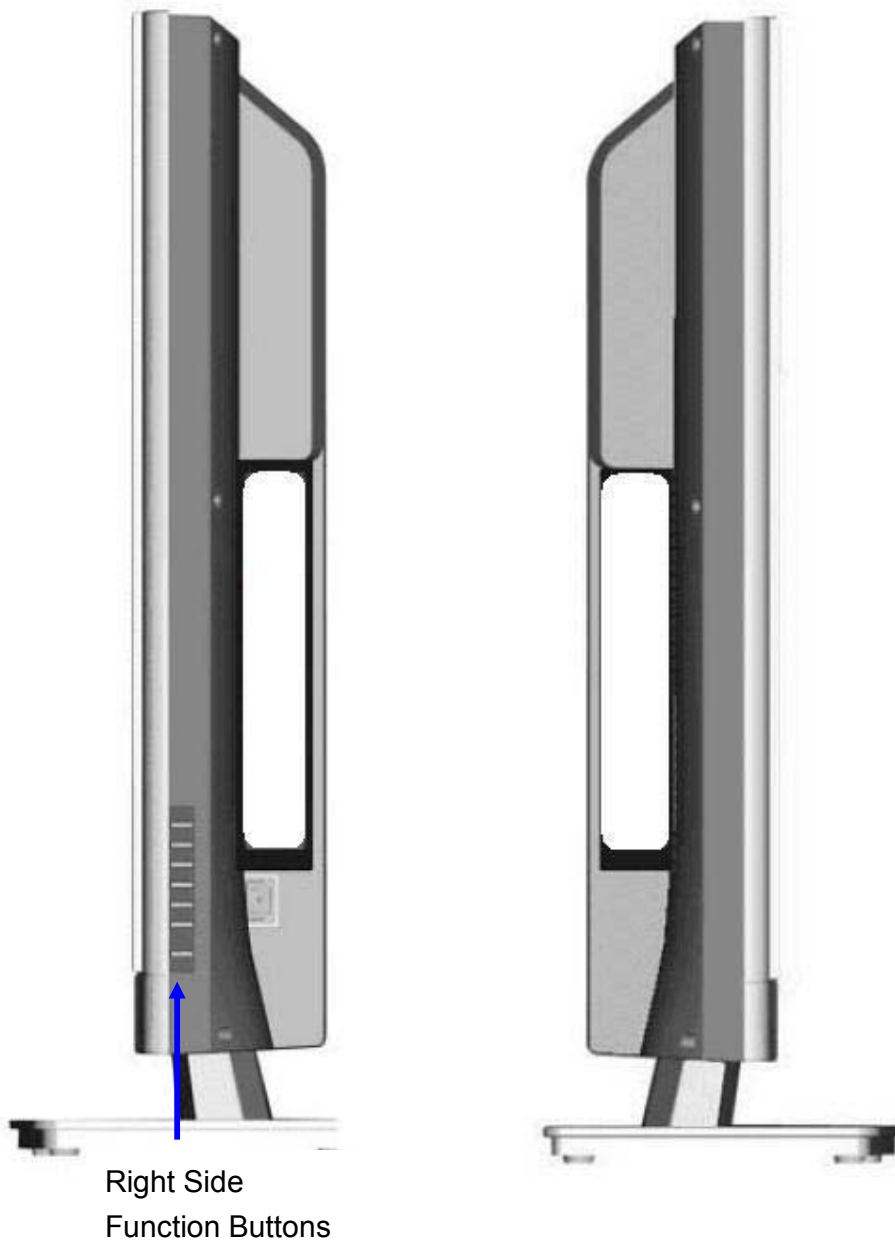

Use the function buttons on the right side of the HD Monitor or on the remote control to display the On Screen Display (OSD).

## **2.2 Feature**

- Highest Resolution

It's the highest resolution 42"/47" 1080p monitor on the market. The Westinghouse VM-42/47F140S features a 1920 x 1080 resolution display with more than 2 million pixels.

- True 1080p

The Westinghouse VM-42/47F140S 1080p monitor is a true 1080p monitor. It can accept, process and output any 1080p source input.

- Multi-Source Input

HDMI x 3,            Support Format: 640 x 480 @ 60Hz, 720 x 400 @ 70Hz,  
800 x 600 @ 60Hz, 800 x 600 @ 72Hz,  
800 x 600 @ 75Hz, 1024 x 768 @ 60Hz,  
1024 x 768 @ 70Hz, 1024 x 768 @ 75Hz  
1280 x 720 @ 60Hz, 1280 x 800 @ 60Hz,  
1280 x 1024 @ 60Hz, 1280 x 1024 @ 75Hz,  
1920 x 1080 @ 60Hz,  
480i/p, 720p, 1080i/p

YPbPr x 2,            Support Format: 480i/p, 720p, 1080i/p

Composite x 1,      Support Format: 480i

S-Video x 1,        Support Format: 480i

D-SUB x 1,            Support Format: 640 x 480 @ 60Hz, 640 x 480 @ 72Hz  
640 x 480 @ 75Hz, 720 x 400 @ 70Hz,  
800 x 600 @ 60Hz, 800 x 600 @ 72Hz  
800 x 600 @ 75Hz, 1024 x 768 @ 60Hz,  
1024 x 768 @ 70Hz, 1024 x 768 @ 75Hz  
1280 x 720 @ 60Hz, 1280 x 1024 @ 60Hz,  
1280 x 1024 @ 75Hz , 1280 x 800 @ 60Hz,  
1920 x 1080 @ 60Hz

DVI x 1, Support Format: 640 x 480 @ 60Hz, 720 x 400 @ 70Hz,  
800 x 600 @ 60Hz, 800 x 600 @ 72Hz,  
800 x 600 @ 75Hz, 1024 x 768 @ 60Hz,  
1024 x 768 @ 70Hz, 1024 x 768 @ 75Hz  
1280 x 720 @ 60Hz, 1280 x 800 @ 60Hz,  
1280 x 1024 @ 60Hz, 1280 x 1024 @ 75Hz,  
1920 x 1080 @ 60Hz,  
480i/p, 720p, 1080i/p

- HD Cable, HD Satellite and HD Gaming

Because the VM-42/47F140S is a true 1080p monitor, you can attach all your favorite sources using uncompressed digital interfaces. Multiple high-bandwidth digital interfaces mean high-performance HD digital cable, HD satellite and an HD game console.

- Design Excellence

The Westinghouse VM-42/47F140S 1080p monitor is the largest screen you can fit in a limited space. Because of its ingenious and efficient design, you can fit this 47" display in the same space that other brands can only squeeze in a 40" or 42". Amazingly thin for its size, it's only 5.0 inches deep (without base), giving you the option of mounting this stylish monitor on your wall. It's true art, Westinghouse-style. Connector access is a breeze with our innovative Spine Design™ technology, allowing easy side access to all connections (not just 1 legacy input) while still on the wall or shelf.

- Great Sound Right Out of the Box

The Westinghouse VM-42/47F140S is a complete entertainment package. A pair of 15 watt speakers that give you an amazing sound experience by themselves, or you can use them to optimize the center field of your existing surround sound system. Convenient switched stereo audio outputs allow the ultimate flexibility for external receivers and surround-sound processors.

## 2.3 Controls and Ports of the Panel

### A. Front Panel Views

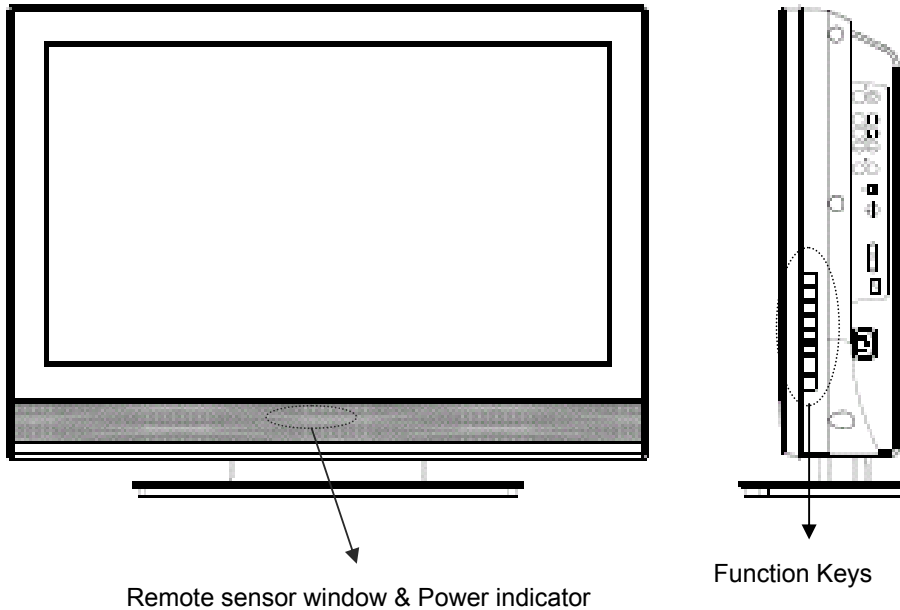

### FUNCTION KEYS

1. **MENU:** Displays the main menu. When OSD is appeared, press the button to select or access the sub-menu.
2. **VOLUME (+ / -):** Increases/decreases the volume or use as the left/right arrow button for menu.
3. **CHANNEL (+ / -):** Changes the Source or use as the up/down arrow button for menu.
4. **SOURCE:** Selects the input source (Video, S-Video, YPbPr1, YPbPr2, PC, DVI, HDMI1, HDMI2, HDMI3)
5. **POWER:** Turns the LCD-MONITOR on or off.
6. **REMOTE SENSOR WINDOW:** Aim the remote control towards this spot on the MONITOR.
7. **POWER INDICATOR :**

WHITE LIGHT	—	Power On
ORANGE LIGHT	—	Power Sleep
OFF LIGHT	—	Power Off

**NOTE 1:** These buttons control the basic features of your MONITOR, including the on-screen menu. To use advanced features, you must use the remote control.

**NOTE 2:** The picture of LCD MONITOR display is for reference only.

## B. Side Panel Views

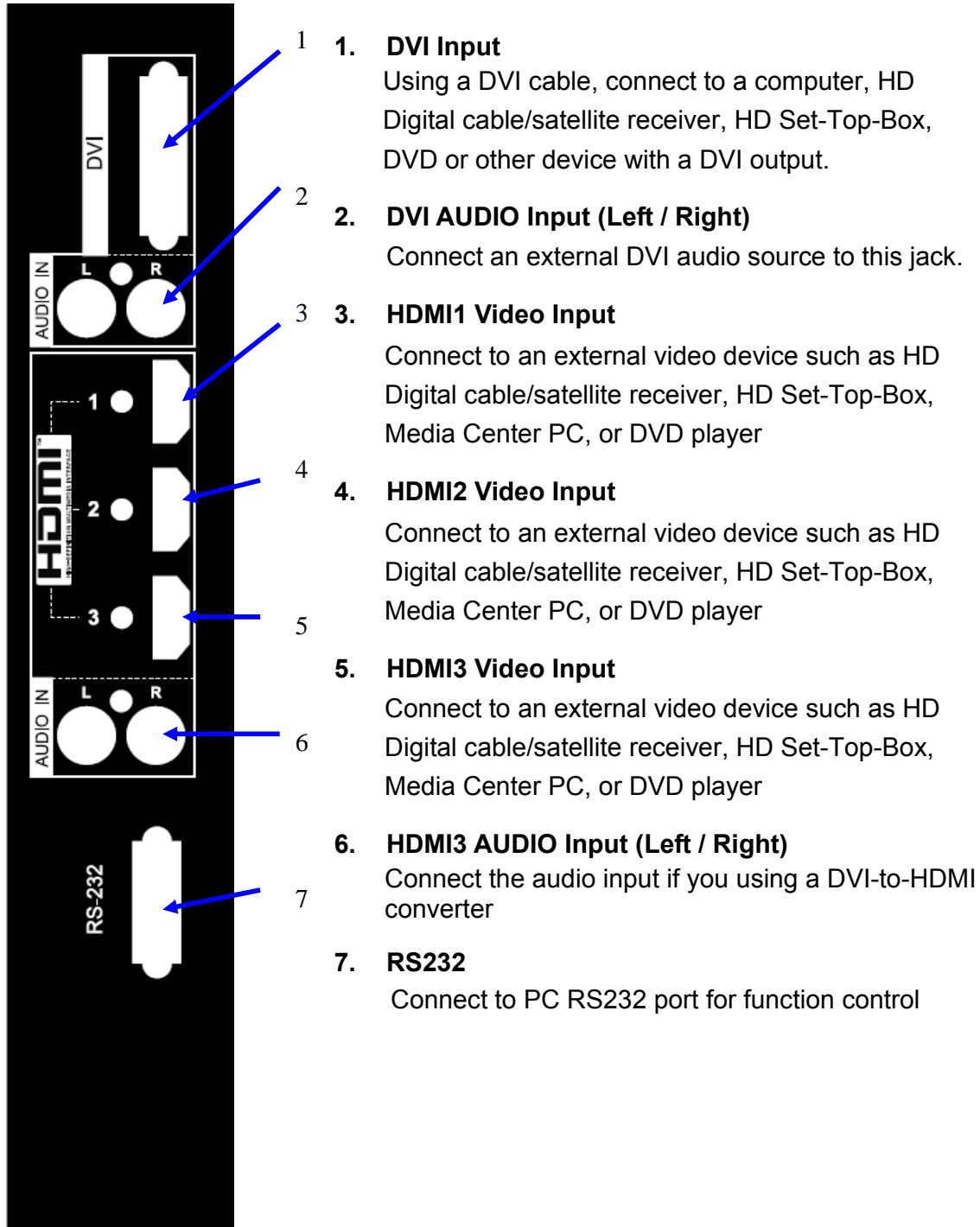

- 1. DVI Input**  
Using a DVI cable, connect to a computer, HD Digital cable/satellite receiver, HD Set-Top-Box, DVD or other device with a DVI output.
- 2. DVI AUDIO Input (Left / Right)**  
Connect an external DVI audio source to this jack.
- 3. HDMI1 Video Input**  
Connect to an external video device such as HD Digital cable/satellite receiver, HD Set-Top-Box, Media Center PC, or DVD player
- 4. HDMI2 Video Input**  
Connect to an external video device such as HD Digital cable/satellite receiver, HD Set-Top-Box, Media Center PC, or DVD player
- 5. HDMI3 Video Input**  
Connect to an external video device such as HD Digital cable/satellite receiver, HD Set-Top-Box, Media Center PC, or DVD player
- 6. HDMI3 AUDIO Input (Left / Right)**  
Connect the audio input if you using a DVI-to-HDMI converter
- 7. RS232**  
Connect to PC RS232 port for function control

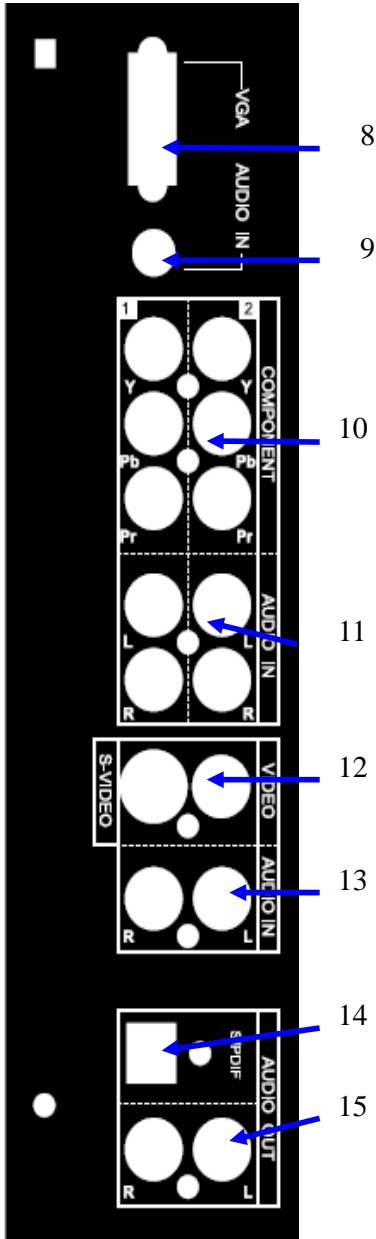

- 8. **VGA Input**  
Using a 15-pin VGA cable, connect to a computer.
- 9. **VGA Audio Input (Stereo)**  
Connect to the audio out from a computer.
- 10. **YPbPr1 / YPbPr2 Video Input**  
Connect an external video device such as DVD or video game system with component output to these jacks
- 11. **Audio Input (Left / Right)**  
Connect an external audio source for component input
- 12. **S-Video / Composite Video Input**
- 13. **Audio Input (Left / Right)**  
Connect an external audio source for S-Video / Composite input
- 14. **SPDIF Output (Optical)**  
Connect this output to an external stereo audio amplifier, receiver or surround sound processor with SPDIF optical input.
- 15. **AUDIO Out**  
Connect this output to an external stereo audio amplifier, receiver or surround sound processor.
- 16. **AC Power In**  
Connect power cable to AC inlet.

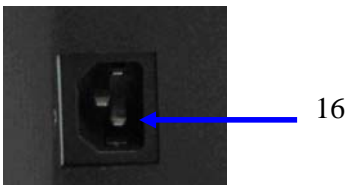

## 2.4 Accessories



User's Manual



Remote Control & Batteries



Power Cord

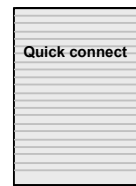

Quick Connect Guide



Warranty Card

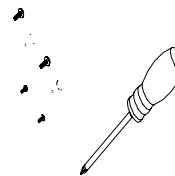

Screw driver & Screws x4(base)

## 2.5 Remote Control

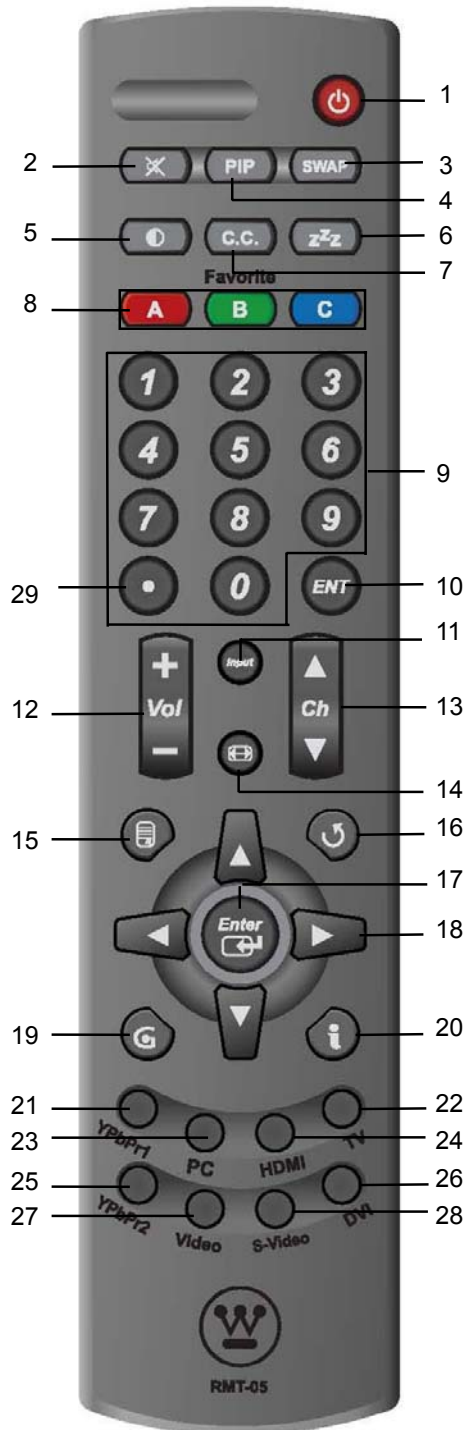

1	<b>Power</b>
	Switch MONITOR power On/Off.
2	<b>Mute</b>
	Turn the sound On/Off.
3	<b>Swap</b>
	Not supported.
4	<b>PIP</b>
	Not supported.
5	<b>Backlight</b>
	Adjust the LCD backlight level.
6	<b>Sleep</b>
	Press to select a preset time interval for automatic power down.
7	<b>C.C.</b>
	Not supported.
8	<b>Favorite</b>
	Not supported.
9	<b>Channel number keys</b>
	Select specific input source.
10	<b>Enter</b>
	Execute a command.
11	<b>Input</b>
	Select input source.
12	<b>VOL +/-</b>
	Volume Up/Down adjustment.
13	<b>CH +/-</b>
	Input source select.
14	<b>Screen Fit</b>
	Adjust scaling
15	<b>Menu</b>
	Display the user setup menu.
16	<b>Return</b>
	Switch to root OSD menu
17	<b>Enter</b>
	Execute a command.
18	<b>▲/▼/◀/▶</b>
	OSD menu control(▲/▼:OSD Menu Up/Down Select; ◀/▶:Volume/Setting Up/Down)

English

Español

Français



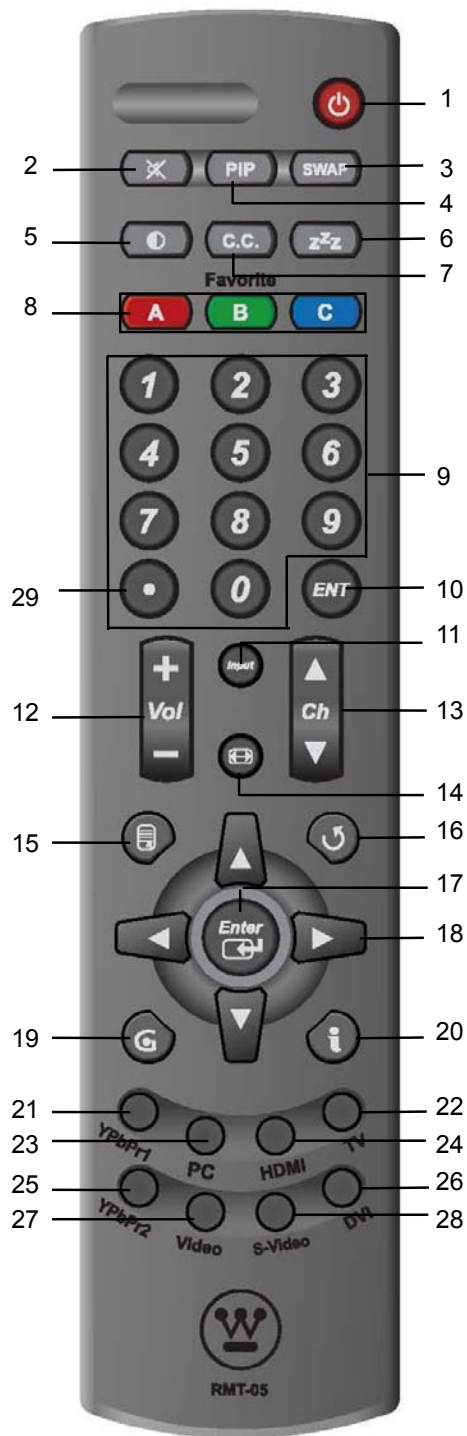

19	<b>Guide</b>
	Not supported.
20	<b>Info</b>
	Display the source information.
21	<b>YPbPr1</b>
	Select YPbPr1 source input.
22	<b>MONITOR</b>
	Not supported.
23	<b>PC</b>
	Select VGA source input.
24	<b>HDMI</b>
	Select HDMI 1, 2 or 3 source input.
25	<b>YPbPr2</b>
	Select YPbPr2 source input.
26	<b>DVI</b>
	Select DVI source input.
27	<b>Video</b>
	Select Video input.
28	<b>S-Video</b>
	Select S-Video input.
29	<b>Dot button</b>
	Not supported.

## 3. INSTALLATION AND FUNCTION ADJUSTMENT

### 3.1 Installation

#### ● Insert Batteries into Remote Control

- 1) Remove the battery cover.
- 2) Insert two size AAA batteries corresponding to (+) and (-) marks on the battery compartment.

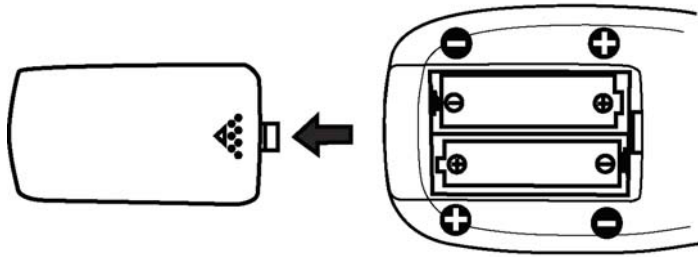

#### CAUTION

- Only use AAA batteries.
- Do not mix new and old batteries. This may result in cracking or leakage, which may pose a fire risk or lead to personal injury.
- Insert batteries according to (+) and (-) markings. Inserting the batteries incorrectly may result in cracking or leakage, which may pose a fire risk or lead to personal injury.
- Dispose of used batteries in accordance with local laws and regulations.
- Keep batteries away from children and pets.
- When the remote control will not be used for an extended period, remove the batteries

- **Connect power cables**

Connect the power cord to the LCD MONITOR then to a proper AC outlet.

IMPORTANT: The power input voltage for MONITOR is 100 ~ 240Vac, before beginning; make sure all devices are turned off.

- **Turn Power On**

Press the power button on the right side of the LCD MONITOR, or press the power (Red) button on the remote control.

- **Select input source for the LCD MONITOR using the OSD menu or remote control direct select buttons**

- **If connecting to a PC(VGA):**

For the best picture quality, set the timing of your computer to 1920 x 1080 at 60Hz.

Refer to the graphic card's user guide of your computer to set this timing.

### **3.2 How to assemble the BASE**

- a. Carefully place the TV face down on a soft clean surface.
- b. Position the BASE at bottom the TV.
- c. Install the four screws underneath the BASE.  
(See picture below)

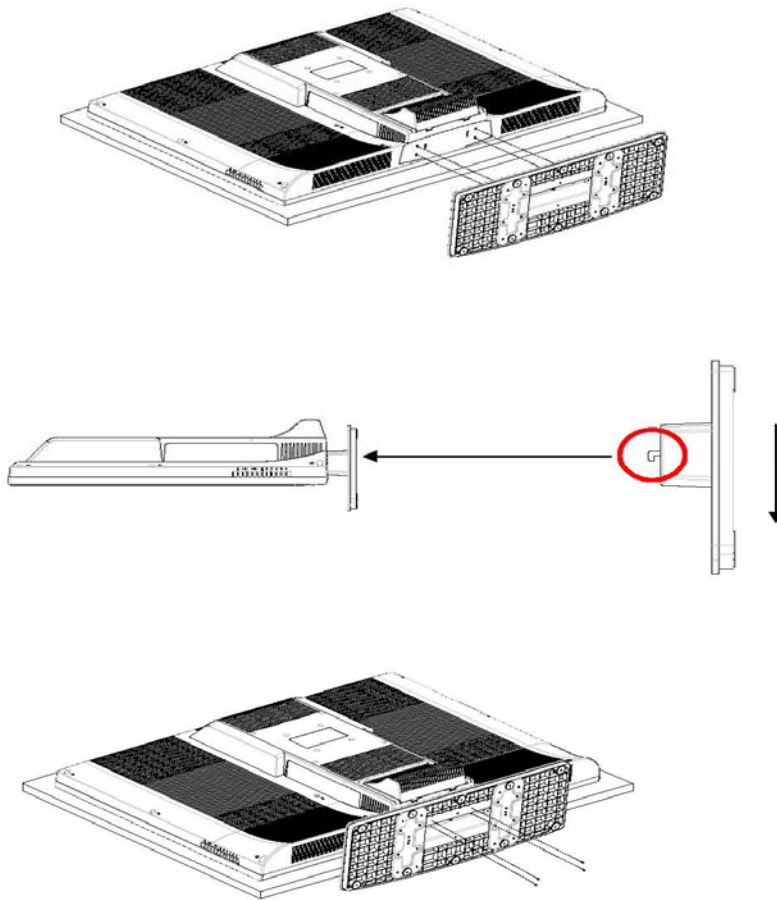

### **3.3 How to remove the BASE**

- a. Carefully place the MONITOR face down on a soft clean surface.
- b. Remove the four screws underneath the BASE.  
(See picture below)
- c. Pull out the BASE from the MONITOR.

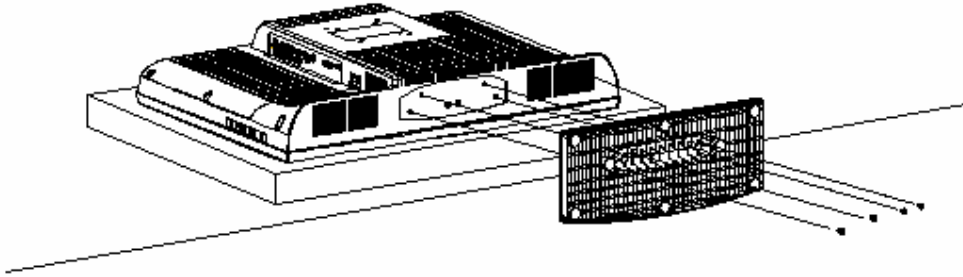

### **3.4 Function Adjustment**

There are four main Setup Menus; these are Picture, PC, Audio and Setting. All the functions can be adjusted either by the remote control or by using the control keys on the right side of the monitor.

#### **Viewing OSD Menu**

To display the main menu, press the Menu button on the right side of front control keys of the LCD MONITOR or the MENU key on the remote control. Press arrow keys to select desired OSD menu and Enter key to select desired setting.

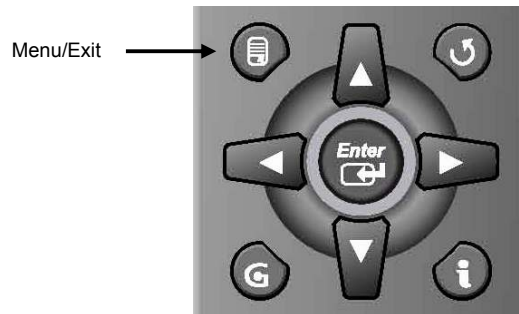

## PICTURE

### 1. PICTURE MODE

< ENHANCE / MOVIE / SPORT / GAME / USER >

Press arrow key to adjust your favorite picture mode setting.

### 2. BRIGHTNESS (For Picture Mode set to USER Only)

< 0 ~ 100 > Press arrow key to adjust brightness setting.

### 3. CONTRAST (For Picture Mode set to USER Only)

< 0 ~ 100 > Press arrow key to adjust contrast setting.

### 4. SATURATION (For Picture Mode set to USER Only)

< 0 ~ 100 > Press arrow key to adjust saturation setting.

### 5. HUE (For Picture Mode set to USER Only)

< 0 ~ 100 > Press arrow key to adjust hue setting.

### 6. COLOR TEMP (For Picture Mode set to USER Only)

< WARM / NEUTRAL / COOL / USER >

Press arrow key to adjust color temperature setting.

### 7. SHARPNESS (For Picture Mode set to USER Only)

< 0 ~ 100 > Press arrow key to adjust sharpness setting.

### 8. BACKLIGHT (For Picture Mode set to USER Only)

< 0 ~ 100 > Press arrow key to adjust your favorite picture mode setting.

### 9. ADVANCE SET

1. DLC < OFF / ON >

2. FILM MODE < NORMAL / QUICK >

3. 3D NR < OFF / LOW / MIDDLE / HIGH >

4. FLESH TONE < 0 ~ 100 >

5. ASPECT RATIO < FILL / STANDARD / OVERSCAN >

Press arrow key to adjust your favorite advance setting.

### 0. RESET

Press Enter key to recover the default picture setting.

## PC

- 1. AUTO** (For PC Analog input only)  
Press Enter key to do PC auto-adjust function.
- 2. CLOCK** (For PC Analog input only)  
< 0 ~ 100 > Press arrow key to adjust PC clock setting.
- 3. PHASE** (For PC Analog input only)  
< 0 ~ 100 > Press arrow key to adjust PC phase setting.
- 4. H-POSITION** (For PC Analog input only)  
< 0 ~ 100 > Press arrow key to adjust PC Horizontal Position setting.
- 5. V-POSITION** (For PC Analog input only)  
< 0 ~ 100 > Press arrow key to adjust PC Vertical Position setting.



## AUDIO

### 1. VOLUME

< 0 ~ 100 > Press arrow key to adjust volume setting.

### 2. EQUALIZER

< STANDARD / MOVIE / MUSIC / USER >

Press arrow key to adjust your favorite equalizer mode setting.

### 3. BASS (For EQUALIZER set to USER Only)

< 0 ~ 100 > (For equalizer is selected as “user” mode only)

Press arrow key to adjust your favorite bass setting.

### 4. TREBLE (For EQUALIZER set to USER Only)

< 0 ~ 100 > (For equalizer is selected as “user” mode only)

Press arrow key to adjust your favorite treble setting.

### 5. BALANCE

< 0 ~ 100 > Press arrow key to adjust balance setting.

### 6. MUTE

< OFF / ON >

Press arrow key to adjust your audio mute function setting.

### 7. SPEAKER

< INTERNAL / EXTERNAL >

Press arrow key to adjust your favorite balance setting.

INTERNAL: For internal speaker

External: For Line out & S/PDIF out

### 8. RESET

Press Enter key to recover the default audio setting.

# SETTINGS

## 1. MENU POSITION

- MENU H-POSITION
- MENU V-POSITION

Press arrow key to adjust menu position.

## 2. MENU TIMEOUT

< OFF / 15S / 30S / 45S / 60S >

Press arrow key to adjust OSD MENU timeout function setting.

## 3. LANGUAGE

< ENGLISH / 繁體中文 / SPANISH / FRENCH >

Press arrow key to adjust OSD MENU timeout function setting.

## 4. SLEEP TIMER

< OFF / 15MIN / 30MIN / 45MIN / 60MIN >

Press arrow key to adjust your favorite equalizer mode setting.

## 5. TRANSPARENCY

< 0 ~ 100 > Press arrow key to adjust transparency function setting.

## 6. POWER SETTING

1. DPMS < OFF / 5S / 10S / 20S >

2. POWER MODE <E. SAVING / NORMAL>

Press arrow key to adjust DPMS function setting.

## 7. ADD. FEATURES

1. LED < ON / OFF >

2. KEY LOCK < ON / OFF >

When KEY LOCK ON, press MENU key in the front panel for about 7 sec to unlock or use Remote Control to set the KEY LOCK OFF.

3. VOLUME MAX < 0 ~ 100 >

4. VOLUME MIN < 0 ~ 100 >

5. START VOLUME SET < OFF / VOLUME MIN ~ VOLUME MAX >

6. START INPUT SET < OFF / VGA / DVI / AV / SV / YPBPR1 / YPBPR2 /  
HDMI1 / HDMI2 / HDMI3 >

7. REMOTE LOCK < ON / OFF >

When REMOTE LOCK ON, press “ i ” key for about 7 sec to unlock.

8. SETUP MENU LOCK < ON / OFF >

When REMOTE LOCK ON, press “ i ” key for about 7 sec to unlock.

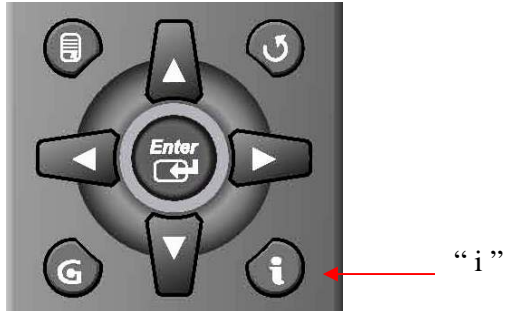

9. SET ID < 0 ~ 99 >

Press arrow key to adjust additional feature function setting.

8. **AUTO SOURCE** < ON / OFF >

Press arrow key to adjust auto source function setting.

9. **SYSTEM INFO**

Press Enter or arrow key to display the system information.

10. **FACTORY RESET**

Press Enter key to recover the default factory setting.

## 4. TROUBLESHOOTING

### There is no picture or sound.

---



- Make sure the AC adapter is connected.
- Verify that there is a valid source signal.
- Make sure the correct input mode is selected.

### There is no picture from AV.

---

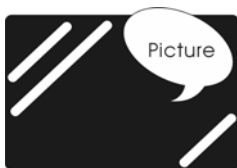

- Make sure the BRIGHTNESS is properly adjusted.
- The florescent lamp may have reached the end of its life. Contact an authorized service center.
- Make sure the video source is plugged into the composite video-in port.

### There is no sound.

---



- Make sure the volume is not set to minimum.
- Make sure the sound is not muted

### There is no picture or sound, just noise.

---

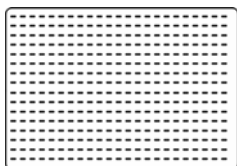

- The source signal may be weak.
- Your provider may be experiencing difficulties.
- Check your input connections.

### Picture is not clear.

---



- The source signal may be weak.
- The provider may be experiencing difficulties.
- Check input connections.

### Picture is light or improperly tinted.

---



- Check the Hue, Saturation and Color adjustments.
- Reset the MONITOR to the factory default settings.

### The picture is too dark.

---



- Select a different Video Preset mode.
- Check the Brightness of Picture Settings.
- The fluorescent lamp may have reached the end of its life. Contact an authorized service center.

### Remote control does not work.

---



- Install new batteries.
- Make sure the remote sensor window isn't blocked.
- Make sure the system is in the right mode (MONITOR / VCR / CBL / AUX)

### There are stripes on the screen or colors fade.

---



- There may be interference from other appliances.
- There may be interference between the video source cable and the power cable.
- Make sure the power and video cables are not touching. Check the Hue, Saturation and Color adjustments

### The picture is not sharp.

---



- The signal source may be weak.
- The provider may be experiencing difficulties.
- Check input connections.
- Check the Sharpness of Picture Settings.

### The picture moves.

---



- The source signal may be weak.
- The provider may be experiencing difficulties.
- Check input connections.

### The picture is doubled or tripled.

---



- The source signal may be weak.
- Check input connections.

### The picture is spotted.

---



- There may be interference from other appliances nearby or around the LCD Monitor.

## 5. PRODUCT SPECIFICATION

ITEMS		VM-42F140S
<b>Panel</b>	Screen Size	42" LCD Panel
	Aspect Ratio	16 : 9
	Resolution	1920 x 1080
	Display colors	16.7 Million True Colors
	Viewing Angle (CR>10)	176° Hor./ 176° Ver. (typ.)
<b>Video Input</b>	Composite Signal	CVBS x 1
	Y, C Signal	S-Video x 1
	Component Signal	Y Pb Pr x 2
	HDMI Connection	HDMI x 3
<b>PC Input</b>	VGA Connection	D-Sub 15 pin x 1
	DVI Connection	DVI x 1
<b>Audio Input</b>	Audio 1	Composite / S-Video Audio L/R Input x 1
	Audio 2	YPbPr Audio L/R Input x 2
	Audio 3	PC Audio Input x 1
	Audio 4	DVI Audio L/R Input x 1
	Audio 5	HDMI Audio L/R Input x 1
<b>Audio Output</b>	Speaker ( build-in)	15W + 15W (Average)
	RCA Out	AUDIO Left / Right Output
	Digital Audio Out	SPDIF Output
<b>Feature</b>	Function Keys	Power , Input , Menu , Up/Down(Channel) , +/- (Volume)
	Video Performance	3D Comb-filter , 3D De-interlace , Aspect Ratio Control (ARC) , Auto Picture Control, Noise Reduction
	Other Control	Sleep Timer, Timer On, Timer Off
<b>Power</b>	Power Supply	AC 100V ~ 240V , 50 / 60Hz
	Power Consumption	< 300 W
<b>Wall Mount</b>	For use only with UL Listed Wall Mount Bracket or M2010 Wall Mount Bracket.	
<b>Dimension</b>	W x H x D	41.5" x 28.2" x 8.9"
<b>Weight (net)</b>	Without Accessories	57.2 lb

ITEMS		VM-47F140S	
<b>Panel</b>	Screen Size	47" LCD Panel	
	Aspect Ratio	16 : 9	
	Resolution	1920 x 1080	
	Display colors	16.7 Million True Colors	
	Viewing Angle (CR>10)	176° Hor./ 176° Ver. (typ.)	
<b>Video Input</b>	Composite Signal	CVBS	x 1
	Y, C Signal	S-Video	x 1
	Component Signal	Y Pb Pr	x 2
	HDMI Connection	HDMI	x 3
<b>PC Input</b>	VGA Connection	D-Sub 15 pin	x 1
	DVI Connection	DVI	x 1
<b>Audio Input</b>	Audio 1	Composite / S-Video Audio L/R Input	x 1
	Audio 2	YPbPr Audio L/R Input	x 2
	Audio 3	PC Audio Input	x 1
	Audio 4	DVI Audio L/R Input	x 1
	Audio 5	HDMI Audio L/R Input	x 1
<b>Audio Output</b>	Speaker ( build-in)	15W + 15W (Average)	
	RCA Out	AUDIO Left / Right Output	
	Digital Audio Out	SPDIF Output	
<b>Feature</b>	Function Keys	Power , Input , Menu , Up/Down(Channel) , +/- (Volume)	
	Video Performance	3D Comb-filter , 3D De-interlace , Aspect Ratio Control (ARC) , Auto Picture Control, Noise Reduction	
	Other Control	Sleep Timer, Timer On, Timer Off	
<b>Power</b>	Power Supply	AC 100V ~ 240V , 50 / 60Hz	
	Power Consumption	< 300 W	
<b>Wall Mount</b>	For use only with UL Listed Wall Mount Bracket or M2010 Wall Mount Bracket.		
<b>Dimension</b>	W x H x D	46.1" x 31.7" x 8.9" (with stand)	
<b>Weight (net)</b>	Without Accessories	69.1lb	

English

Español

Français





[www.wde.com](http://www.wde.com)