



Dear VIZIO Customer,

Congratulations on your new VIZIO SV320XVT & SV370XVT television purchase. Thank you for your support. For maximum benefit of your set, please read these instructions before making any adjustments, and retain them for future reference. We hope you will experience many years of enjoyment from your new VIZIO HDTV High Definition Television.

For assistance, please call **(877) 668-8462** or e-mail us at www.vizio.com.

To purchase or inquire about accessories and installation services for your VIZIO HDTV, please visit our website at www.vizio.com or call toll free at **(888) 849-4623**.

We recommend you register your VIZIO HDTV either at our website www.VIZIO.com or fill out and mail your registration card. For peace of mind and to protect your investment beyond the standard warranty, VIZIO offers on-site extended warranty service plans. These plans give additional coverage during the standard warranty period. Visit our website or call us to purchase a plan.

Write down the serial number located on the back of your HDTV.

Purchase Date _____

*VIZIO is a registered trademark of VIZIO, Inc. dba V, Inc.
HDMI logo and "High Definition Multimedia Interface" are registered trademarks of HDMI Licensing LLC.
Manufactured under license from Dolby Laboratories.
Dolby and the double-D symbol are trademarks of Dolby Laboratories.*



*TruSurround HD and TruVolume are trademarks of SRS Labs, Inc.
TruSurround HD and TruVolume technologies are incorporated under license from SRS Labs, Inc.*

THE TRADEMARKS SHOWN HEREIN ARE THE PROPERTY OF THEIR RESPECTIVE OWNERS; IMAGES USED ARE FOR ILLUSTRATION PURPOSES ONLY. BRAVO, VIZIO AND THE V LOGO AND WHERE VISION MEETS VALUE AND OTHER VIZIO TRADEMARKS ARE THE INTELLECTUAL PROPERTY OF VIZIO INC. PRODUCT SPECIFICATIONS ARE SUBJECT TO CHANGE WITHOUT NOTICE OR OBLIGATION. © 2008 VIZIO INC. ALL RIGHTS RESERVED.



Important Safety Instructions

Your HDTV is designed and manufactured to operate within defined design limits, and misuse may result in electric shock or fire. To prevent your HDTV from being damaged, the following rules should be observed for the installation, use, and maintenance of your HDTV. Read the following safety instructions before operating your HDTV. Keep these instructions in a safe place for future reference.

- To reduce the risk of electric shock or component damage, switch off the power before connecting other components to your HDTV.
- Unplug the power cord before cleaning your HDTV. A damp cloth is sufficient for cleaning your HDTV. Do not use a liquid or a spray cleaner for cleaning your HDTV. Do not use abrasive cleaners.
- Always use the accessories recommended by the manufacturer to insure compatibility.
- When moving your HDTV from an area of low temperature to an area of high temperature, condensation may form in the housing. Wait before turning on your HDTV to avoid causing fire, electric shock, or component damage.
- Use only with the cart, stand, tripod, bracket, or table specified by manufacturer or sold with your HDTV. When a cart is used, use caution when moving the cart/HDTV combination to avoid injury from tip-over. Do not place your HDTV on an unstable cart, stand, or table. If your HDTV falls, it can injure a person and cause serious damage to your HDTV. Use only a cart or stand recommended by the manufacturer or sold with your HDTV.
- A distance of at least 3 feet should be maintained between your HDTV and any heat source, such as a radiator, heater, oven, amplifier etc. Do not install your HDTV close to smoke. Operating your HDTV close to smoke or moisture may cause fire or electric shock.
- Slots and openings in the back and bottom of the cabinet are provided for ventilation. To ensure reliable operation of your HDTV and to protect it from overheating, be sure these openings are not blocked or covered. Do not place your HDTV in a bookcase or cabinet unless proper ventilation is provided.
- Never push any object into the slots and openings on your HDTV cabinet. Do not place any objects on the top of your HDTV. Doing so could short circuit parts causing a fire or electric shock. Never spill liquids on your HDTV.
- Your HDTV should be operated only from the type of power source indicated on the label. If you are not sure of the type of power supplied to your home, consult your dealer or local power company.
- Do not apply pressure or throw objects at your HDTV. This may compromise the integrity of the display. The manufacturer's warranty does not cover user abuse or improper installations.
- The power cord must be replaced when using different voltage than the voltage specified. For more information, contact your dealer.
- Your HDTV is equipped with a **three-pronged grounded plug (a plug with a third grounding pin)**. This plug will fit only into a grounded power outlet. This is a safety feature. If your outlet does not accommodate the three-pronged, have an electrician install the correct outlet, or use an adapter to ground your HDTV safely. **Do not defeat the safety purpose of the grounded plug.**
- When connected to a power outlet, power is always flowing into your HDTV. To totally disconnect power, unplug the power cord.



- The lightning flash with arrowhead symbol within an equilateral triangle is intended to alert the user to the presence of un-isolated, dangerous voltage within the inside of your HDTV that may be of sufficient magnitude to constitute a risk of electric shock to persons.



- The exclamation point within an equilateral triangle is intended to alert the user to the presence of important operating and servicing instructions in the literature accompanying your HDTV.
- Do not overload power strips and extension cords. Overloading can result in fire or electric shock.



- The wall socket should be installed near your HDTV and easily accessible.
- Only power of the marked voltage can be used for your HDTV. Any other voltage than the specified voltage may cause fire or electric shock
- Do not touch the power cord during lightning. To avoid electric shock, avoid handling the power cord during electrical storms.
- Unplug your HDTV during a lightning storm or when it will not be used for long period of time. This will protect your HDTV from damage due to power surges.
- Do not attempt to repair or service your HDTV yourself. Opening or removing the back cover may expose you to high voltages, electric shock, and other hazards. If repair is required, contact your dealer and refer all servicing to qualified service personnel.
- Keep your HDTV away from moisture. Do not expose your HDTV to rain or moisture. If water penetrates into your HDTV, unplug the power cord and contact your dealer. Continuous use in this case may result in fire or electric shock.
- Do not use your HDTV if any abnormality occurs. If any smoke or odor becomes apparent, unplug the power cord and contact your dealer immediately. Do not try to repair your HDTV yourself.
- Avoid using dropped or damaged appliances. If your HDTV is dropped and the housing is damaged, the internal components may function abnormally. Unplug the power cord immediately and contact your dealer for repair. Continued use of your HDTV may cause fire or electric shock.
- Do not install your HDTV in an area with heavy dust or high humidity. Operating your HDTV in environments with heavy dust or high humidity may cause fire or electric shock.
- Follow instructions for moving your HDTV. Ensure that the power cord and any other cables are unplugged before moving your HDTV.
- When unplugging your HDTV, hold the power plug, not the cord. Pulling on the power cord may damage the wires inside the cord and cause fire or electric shock. When your HDTV will not be used for an extended period of time, unplug the power cord.
- To reduce risk of electric shock, do not touch the connector with wet hands.
- Insert batteries in accordance with instructions. Incorrect polarities may cause the batteries to leak which can damage the remote control or injure the operator.
- If any of the following occurs, contact the dealer:
 - The power cord fails or frays.
 - Liquid sprays or any object drops into your HDTV.
 - Your HDTV is exposed to rain or other moisture.
 - Your HDTV is dropped or damaged in any way.
 - The performance of your HDTV changes substantially.



Television Antenna Connection Protection

External Television Antenna Grounding

If an outside antenna/satellite dish or cable system is to be connected to the TV, make sure that the antenna or cable system is electrically grounded to provide some protection against voltage surges and static charges.

Article 810 of the National Electrical Code, ANSI/NFPA 70, provides information with regard to proper grounding of the mast and supporting structure, grounding of the lead-in wire to an antenna discharge unit, size of the grounding conductors, location of antenna discharge unit, connection to grounding electrodes, and requirements of the grounding electrode.

Lightning Protection

For added protection of the TV during a lightning storm or when it is left unattended or unused for long periods of time, unplug the TV from the wall outlet and disconnect the antenna or cable system.

Power Lines

Do not locate the antenna near overhead light or power circuits, or where it could fall into such power lines or circuits.

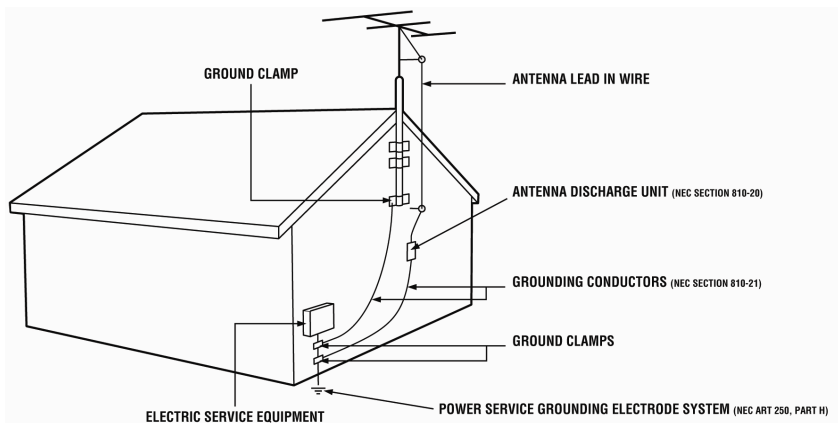

Remember, the screen of the coaxial cable is intended to be connected to earth in the building installation.



Advisory of the DTV Transition

The nationwide switch to digital television broadcasting will be complete on June 12, 2009, but your local television stations may switch sooner. After the switch, analog-only television sets that receive TV programming through an antenna will need a converter box to continue to receive over-the-air TV. Watch your local stations to find out when they will turn off their analog signal and switch to digital-only broadcasting. Analog-only TVs should continue to work as before to receive low power, Class A or translator television stations and with cable and satellite TV services, gaming consoles, VCRs, DVD players, and similar products.

For additional information, please contact the parties listed below, as appropriate:

FCC (US Federal Communications Commission)

<http://www.fcc.gov/>

Phone: 1-888-CALL-FCC (1-888-225-5322)

TTY: 1-888-TELL-FCC (1-888-835-5322)

Fax: 1-866-418-0232

E-mail: fccinfo@fcc.gov

NTIA (National Telecommunications and Information Administration)

<http://www.ntia.doc.gov/>

1-888-DTV-2009

Listings of US Television Stations

<http://www.high-techproductions.com/usTVstations.htm>

Note: Your VIZIO HDTV is capable of receiving Digital Broadcasts, and no Digital Converter Box is required.



Table of Contents

Important Safety Instructions.....	2
Television Antenna Connection Protection	4
Advisory of the DTV Transition.....	5
TV Setup and Stand Assembly	10
Setting Up Your HDTV	11
Wall Mounting your HDTV.....	11
CHAPTER 1 BASIC CONTROLS AND CONNECTIONS.....	12
Front Panel.....	12
Side Panel Controls.....	12
Rear Panel Connections.....	13
VIZIO Remote Control.....	14
Quick Menu Operation.....	15
Insertion of Batteries in the Remote Control.....	16
Remote Control Range.....	16
VIZIO Remote Control Precautions	16
CHAPTER 2 CONNECTING EQUIPMENT.....	17
Which Video Connection Should I Use?	17
Connecting Your Cable or Satellite Box.....	18
Using HDMI (Best).....	18
HDMI Connections for Cable or Satellite Boxes with DVI	19
Using Component Video (Better).....	19
Using S-Video (Compatible)	20
Using Composite Video (Compatible).....	20
Using Coaxial (Antenna) (Compatible).....	20
Connecting Coaxial (RF).....	21
Using Your Antenna or Digital Cable for Standard TV or Digital TV	21
Using the Antenna or Cable through Your VCR.....	21
Connecting Your DVD Player.....	22
Using HDMI (Best).....	22
HDMI Connections for DVD Players with DVI	22
Using Component Video (Better).....	23
Using S-Video (Compatible)	23
Using Composite (AV) Video (Compatible)	24
Connecting Your VCR or Video Camera.....	24
Connecting an External Receiver/Amp	25
Optical Output of audio received with HD Programs.....	25
Connecting a Computer.....	26
Preset PC Resolutions.....	27
Resolution through RGB Input.....	27
CHAPTER 3 USING THE MEDIA PORT.....	28
Supported File Formats.....	28
Viewing Multimedia Content.....	29
Picture Settings	30
Slideshow Mode.....	30
Slideshow with Music.....	30
Music file browser	30
Audio Mode.....	30
Repeat.....	30
Sort By	30
Duration	30
Slideshow Effect	31



Thumbnail Size	31
Info	31
Music Settings	31
Sort By	31
Play Mode	31
Repeat.....	31
Audio Mode	31
Info	31
Video Settings	32
Sort By	32
Play Mode	32
Repeat.....	32
Picture Mode	32
Wide Format	32
Audio Mode	32
Info	32
CHAPTER 4 USING YOUR HDTV THE FIRST TIME.....	33
Setup Wizard	33
Select Input Source	35
Fine Tuning the picture.....	36
Watching a TV Program	37
Adjusting Basic HDTV Settings	38
Program Information.....	38
CHAPTER 5 ADVANCED ADJUSTMENT OF HDTV.....	39
Using the On Screen Display (OSD).....	39
Picture Menu	40
Picture Mode	40
Backlight	40
Brightness	40
Contrast	40
Color.....	40
Tint	40
Sharpness.....	40
Advanced Video.....	41
Reset Picture Mode	41
Audio Menu	42
Audio Mode.....	42
Equalizer	42
Balance	42
SRS TSHD.....	42
SRS TruVolume	42
Digital Audio Out.....	42
Speakers.....	42
Analog Audio Out.....	43
Lip Sync	43
Reset Audio Mode	43
TV Menu	44
Tuner Mode.....	44
Auto Search	44
Partial Channel Search.....	44
Skip Channel.....	44
MTS.....	44
Time Zone.....	44
Daylight Saving	44



Channel Info.....	44
Setup Menu	45
Language	45
PIP	45
CEC Menu	46
Sleep Timer.....	46
Wide.....	46
Input Naming.....	47
CC (Closed Caption).....	47
H/V Position	48
Parental.....	48
System Info	50
System Reset.....	50
Understanding Viewing Features	51
Viewing Modes	51
CHAPTER 6 PROGRAMMING THE VIZIO UNIVERSAL REMOTE CONTROL.....	52
Programming for VCR.....	52
Programming for Cable Set-Top Box.....	52
Programming for DVD Player	53
Searching for Component Codes	53
Using a Cable or Satellite Remote	53
CHAPTER 7 MAINTENANCE AND TROUBLESHOOTING	54
Maintenance	54
Troubleshooting Guide	55
Telephone & Technical Support	57
Compliance.....	58
FCC Class B Radio Interference Statement	58
CHAPTER 8 SPECIFICATIONS	59
Remote Control Codes	61
LIMITED PRODUCT WARRANTY	81
VIZIO RETURN POLICY.....	82
Index.....	84



Opening the Package

Your HDTV and its accompanying accessories are carefully packed in a cardboard carton that has been designed to protect it from transportation damage. Once you have opened the carton, check that your HDTV is in good condition and that all of the contents are included.

The screen can easily be scratched or broken, so handle your HDTV gently and never place your HDTV with the screen facing downwards on a surface without protective padding.

IMPORTANT: Save the carton and packing material for future shipping.

Package Contents

- VIZIO SV320XVT or SV370XVT
- Stand with thumb screw (attached)
- VIZIO remote control VUR9M
- AAA batteries for remote control (2)
- Power cord
- Cleaning Cloth
- This user manual
- Quick Setup Guide
- Registration Card



Additional certified accessories for your HDTV are sold separately:

- Wall mounts
- High Definition cables
- Extra or replacement remote control

VIZIO also offers installation services and extended warranty services for your HDTV.

To purchase or inquire about additional accessories and services for your VIZIO HDTV, visit our web site at www.VIZIO.com or call us toll free at 888-VIZIOCE (888-849-4623)

Caution: Do not apply pressure or throw objects at your HDTV. This may compromise the integrity of the display. The manufacturer's warranty does not cover user abuse or improper installations.



TV Setup and Stand Assembly

To unpack the TV and stand base:

1. Remove the remote control, batteries, and power cord from the foam end caps.
2. Remove the top foam end caps.
3. Remove the stand base and the thumb screw.
4. Remove the TV from the box and lay it face down on a clean, flat surface.

Note: Make sure that the surface is free of debris to prevent the TV screen from getting scratched.

To attach the TV stand base:

1. Push the stand base onto the stand neck (already connected to TV).
2. On the bottom of the base, insert the thumb screw and tighten. Move the TV into an upright position.

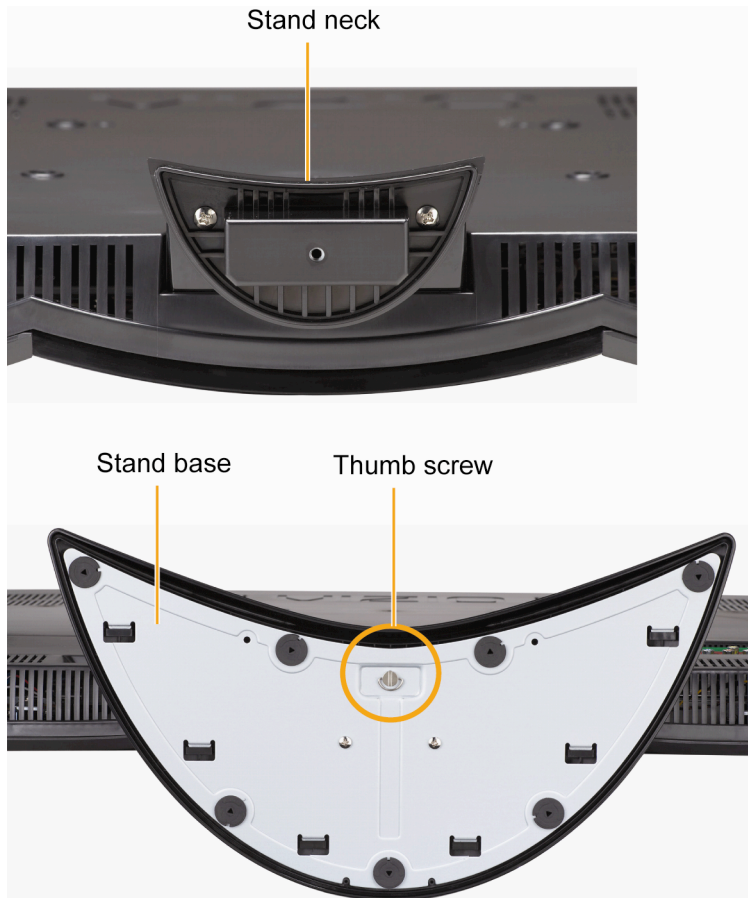

Setting Up Your HDTV

- Read this user manual carefully before installing your HDTV.
- The power consumption of your HDTV is about 98W (AVG) for the SV320XVT; 125W (AVG) for the SV370XVT. Use the included power cord. When an extension cord is required, use one with the correct power rating. The cord must be grounded and the grounding feature must not be compromised.
- Your HDTV should be installed on a flat surface to avoid tipping.
- For proper ventilation, you must allow space between the back of your HDTV and the wall.
- If you want to mount your HDTV on the wall, see below for additional information.
- Avoid installing your HDTV in places with high humidity, dust, or smoke so you do not shorten the service life of the electronic components.
- Install your HDTV in a level, landscape orientation, with the VIZIO logo at the bottom to prevent poor ventilation and excessive component damage.

VIZIO offers professional installation services. Contact VIZIO for more information on these services at 888-VIZIOCE (888-849-4623) or www.VIZIO.com.

Wall Mounting your HDTV

Your HDTV can be mounted on the wall for viewing. If you choose to mount your HDTV on the wall, follow the instructions below.

1. Remove the stand base and neck:
 - a. Disconnect the cables from your HDTV.
 - b. Place your HDTV face down on a soft, flat surface to prevent damage to the screen.
 - c. Remove the six screws and pull off base.

Note: To remove the base from the neck, unscrew thumbscrew on bottom.

2. Mount your HDTV on the wall:
 - a. Attach your HDTV to a wall mount (sold separately) using the mounting holes in the back panel of your HDTV.
 - b. Read the instructions that came with your specific wall mount to properly hang your HDTV.

Note: Use M6 x 20mm 1.0 pitch screws in two upper holes, M6 x 14mm in two lower holes.

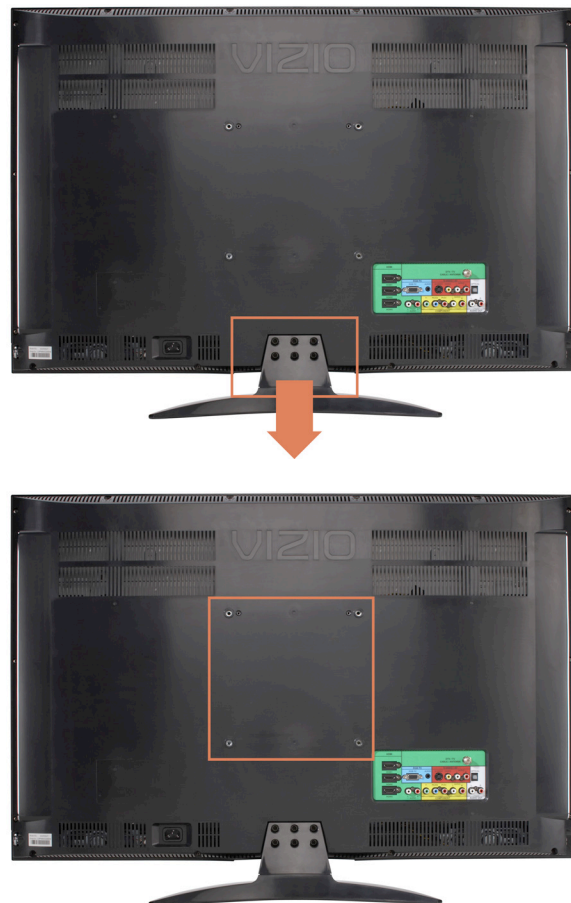

Chapter 1 Basic Controls and Connections

Front Panel

POWER 'VIZIO' LIGHT– The VIZIO name lights white when powered on and orange when powered off.

REMOTE CONTROL SENSOR – Point the remote control directly at this window for the best response to the remote signal.



Side Panel Controls



Right side

POWER/Jog Wheel () – Switch the HDTV on by pressing the button once. Press the button again to turn the HDTV off.



Left side

Multimedia Port – Insert a FAT/FAT32 formatted USB drive to view pictures, listen to music, or watch movies.



Rear Panel Connections

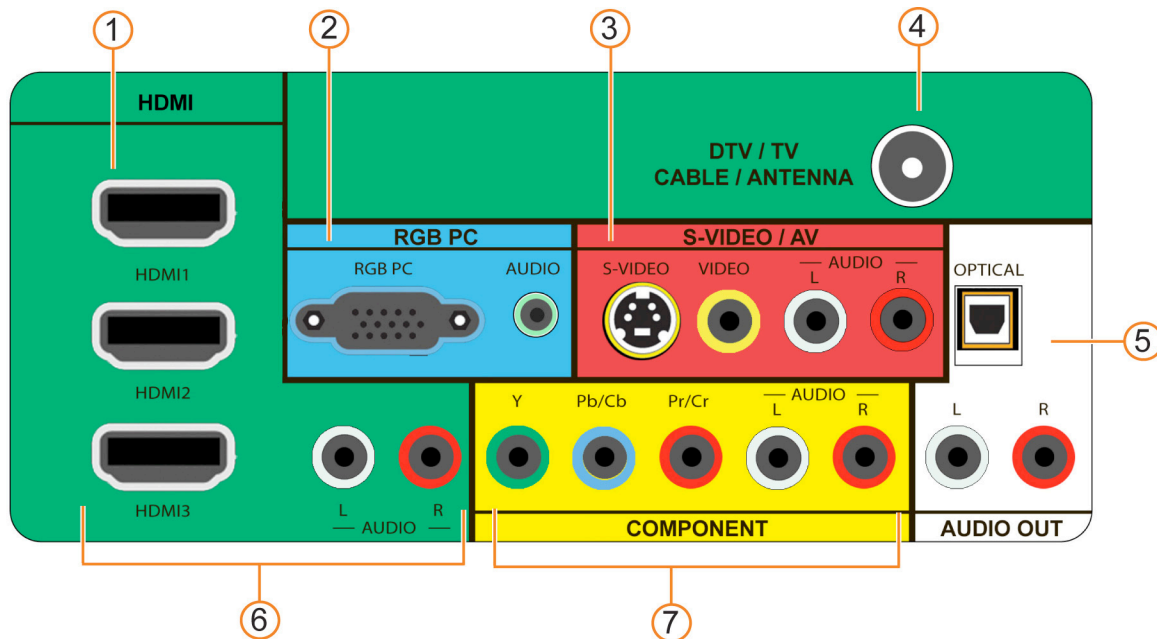

1. **HDMI 1 & 2** – Connect digital video devices such as DVD multimedia players or set top box through these all digital connectors.
2. **RGB PC** – Connect the video and audio from a computer here. A cable with a 1/8" mini plug stereo connector at the end connecting to the TV is needed if sound is also transmitted with this signal.
3. **S-VIDEO/AV** – Connect composite or S-Video video devices, such as a VCR or video game. Use the white and red connectors to connect the external audio from the same source.
4. **DTV/TV** – Connect to an antenna or digital cable (no Cable Box) for Digital TV. For digital TV stations in your area visit www.antennaweb.org.
5. **AUDIO OUT** –
 - a. (OPTICAL) When digital TV is selected for viewing, the audio associated with the programming will be available on the SPDIF Optical connector for connection to your home theater system.
 - b. (ANALOG L/R) Connect the audio from the HDTV to an external device, such as a home theater system, external amplifier or stereo. Speakers can not be connected directly here.
6. **HDMI 3** - Connect another digital video device such as a DVD multimedia player or set top box through this all digital connector. For users who want to connect to a DVI enabled device, use a DVI-HDMI cable and connect the analog audio output of the device to the L+R AUDIO here. Your VIZIO Certified HDMI and HDMI-DVI cables are available for purchase from www.VIZIO.com or by calling 888-VIZIOCE (888-849-4623).
7. **COMPONENT (YPb/CbPr/Cr with Audio L/R)** – Connect component video devices such as a DVD Player or set top box here.



VIZIO Remote Control



POWER () – Press this button to turn the TV on from the Standby mode. Press it again to return to the Standby mode.

SET – This button starts all programming of the Remote Control.

HDMI – Press this button to select the HDMI input. By pressing it repeatedly you will go through all HDMI inputs in sequence.

COMP – Press this button to select Component input.

AV – Press this button to select AV (either Composite or S-Video) input.

TV – Press this button to select TV.

PIP – Pressing this button will activate the picture-in-picture feature. The screen will display the sub-screen in the corner over the main screen. Pressing it again will display the POP (Picture Outside Picture) option.
P.SIZE – Repeatedly press this button to set the size of the PIP screen to small, medium, or large.

P.INPUT – Press the button to choose the input source for the PIP screen.

P.CH – Press this button to change the channels in the PIP screen when TV is selected as PIP input.

WIDE – This button cycles through the available screen formats. The options are Zoom1, Zoom2, Stretch, Panoramic, Full, and Normal (depending on input selected).

FREEZE – Press this button to “Freeze-Frame” the current screen. Press this button again to continue playing.

MTS – This button will select the MTS options of Stereo, SAP or Mono in standard TV mode and alternate audio channels, where available, in DTV mode.

SWAP – While in PIP/POP mode; pressing SWAP will switch the displays from the main screen to the sub-screen or vice versa.

MODE – Use this button to change the picture mode from Custom, Standard, Movie, Game, Vivid, Football, Golf, Basketball, and Baseball.

INFO – This button displays the image and system information display.

P.AUDIO – Press this button to switch the audio from the main screen to the sub-screen while in PIP or POP mode.

CC – This button will select the Closed Caption mode.

DVD – This button selects a programmed DVD player.

AUDIO – This button selects a programmed Audio Receiver/Amp/Home Theater System.

CABLE – This button selects a programmed cable TV set-top box or a satellite TV set-top box.

TV – This button has been pre-programmed to select the codes to operate the VIZIO HDTV.

MENU – Use this button for the On-Screen Display (OSD) menu. When it is used within a menu selection, pressing this button will return to the previous selection or exit the menu.

EXIT – Press this button to exit from the On-Screen Display (OSD) menu

OK – Use this button for the On-Screen Display (OSD) menu. Press it to confirm or choose a highlighted menu selection. In Multi Media mode,



press this button to select folders and files and to play/pause a slideshow, playing music, or movies.

▲▼◀▶ -These buttons are used to navigate the OSD menu. They will also be used as value settings when the slide bar is shown on the screen and option settings to turn a feature off or on.

GUIDE – This button displays program information. Note: This function is only available on DTV.

LAST – This button recalls the previously viewed channel. If the On-Screen Display (OSD) menu is being used, this button will allow you to get back to previous menu screen or out to your program when you press it repeatedly.

MEDIA – Press this button to view pictures, listen to music, or watch movies on a USB drive connected to the Multi Media port on the side of the HDTV.

VOL +/- – This button turns the volume up or down.

CH ▲/▼ – This button changes the channels up or down.

MUTE – This button turns the sound on and off.

NUMBER BUTTON PAD – Use these buttons to select a channel or enter a password.

INPUT – This button allows the user to cycle through the inputs. Repeatedly pressing this button will step you through the input sources in the following sequence: TV, AV, Component, RGB, HDMI1, HDMI2, and HDMI3. Once you have stepped through the entire sequence, you will return to the beginning.

- **(DASH)** – When selecting a digital channel directly, use this button between the main and sub-channels. For example, channel 28-2 would be selected by the button sequence 2, 8, DASH, 2.

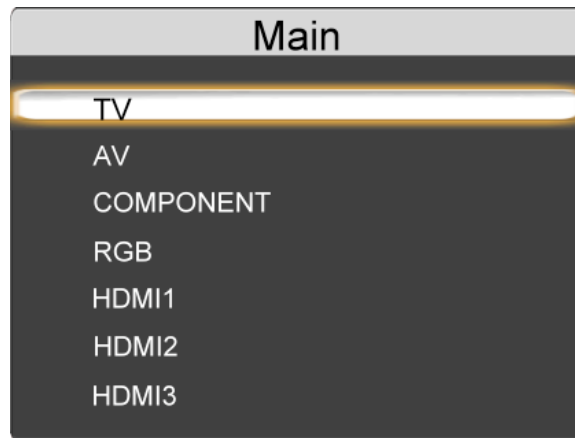

Quick Menu Operation

Standby/Power on

By pressing the Power button, VIZIO logo turns to white to indicate power on. To turn off the HDTV, press this button again.

Note: When the Quick Menu is not displayed, pressing this button turns the HDTV On or Off.

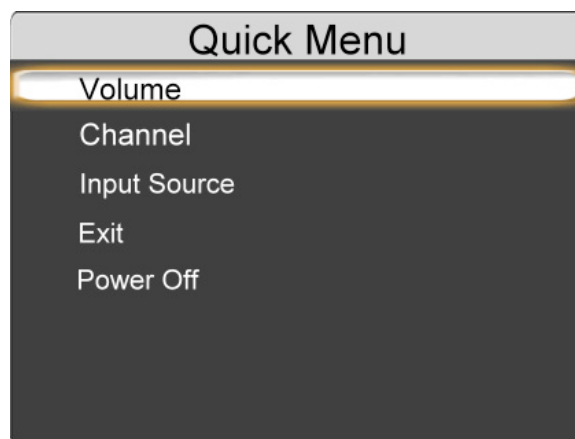

Menu operation

Rotate the Jog Wheel Left or Right to activate the QUICK MENU, then rotate Left or Right to select one of the functions:

Volume adjustment

Rotate the Jog Wheel Left or Right to select **Volume** and press in on the button. Rotate the Jog Wheel Left or Right to increase or decrease volume.

Channel selection

Rotate the Jog Wheel Left or Right to select **Channel** and press in on the button. A Channel list will appear. Select a channel by rotating the Jog Wheel Left or Right, then press in on the button to confirm the channel selection.



Input Source

Rotate the Jog Wheel Left or Right to select **Input** and press in on the button. Rotate the Jog Wheel Left or Right to cycle through the input sources by the following sequence: TV, AV(S-video or Composite), COMPONENT, RGB ,HDMI1 , HDMI2, HDMI3. Press in on the button to confirm the channel selection.

Exit

Rotate the Jog Wheel Left or Right to select **Exit**. Press in on the button to exit the Quick Menu.

Power Off

Rotate the Jog Wheel Left or Right to select Power Off and Press in to turn off the HDTV.

Note: When the Quick Menu is displayed and no selection is made within three seconds, the menu will exit automatically.

Insertion of Batteries in the Remote Control

Insert two AAA batteries into the remote control. Make sure that you match the (+) and (-) symbols on the batteries with the (+) and (-) symbols inside the battery compartment. Re-attach the battery cover.

Precautionary Tips for Inserting the Batteries:

- Only use the specified AAA batteries.
- Do not mix new and old batteries. This may result in cracking or leakage that may pose a fire risk or lead to personal injury.
- Inserting the batteries incorrectly may also result in cracking or leakage that may pose a fire risk or lead to personal injury.
- Dispose of the batteries in accordance with local laws and regulations.
- Keep the batteries away from children and pets.



Remote Control Range

Point the remote control at the remote control sensor to transmit the commands.

Do not place any obstacles between the remote control and the receiver window.

The effective range of the remote control is approximately 30 feet (10 meters) from the front of the receiver window, 30° to the left and right, 20° up and down.

VIZIO Remote Control Precautions

The remote control should be kept dry and away from heat sources. Avoid humidity.

If the TV responds erratically to the remote control or does not respond at all, check the batteries. If the batteries are low or exhausted, replace them with fresh batteries.

When not using the remote control for a long period of time, remove the batteries.

Do not take the batteries apart, heat them, or throw them into a fire.

Do not subject the remote control to undue physical stress, such as striking or dropping it.



Do not attempt to clean the remote control with a volatile solvent. Wipe it with a clean, damp cloth.



Chapter 2 Connecting Equipment

Which Video Connection Should I Use?

The VIZIO HDTV has six different ways to connect your video equipment from a basic connection to the most advanced for digital displays.

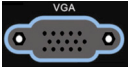
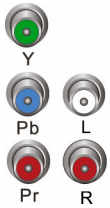
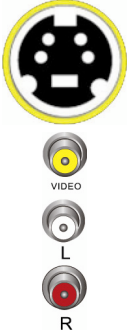
Connection Quality (type)	Connector	Description
Best (digital)	 HDMI	HDMI provides an interface between any audio/video source, such as a set-top box, DVD player, or A/V receiver and a digital television (DTV), over a single cable.
Best (digital) ----- Compatible (analog)		Connect a digital or analog antenna cable or coaxial cable to watch TV programming.
Best (analog)	 VGA	RGB PC (VGA) – This is most commonly used for PC input.
Better (analog)		Component - Component video provides a sharper image than composite video and S-video because the three video signals are transmitted via three separate channels.
Compatible (analog)		S-Video (AV) - Combining the three video signals into two channels, S-Video provides a sharper image than Composite video, but is not as good as Component video. Composite (AV) - All three video signals are combined into one channel, thus making the image less sharp than Component or S-Video.



Connecting Your Cable or Satellite Box

You have four options for connecting your cable or satellite box to your HDTV: HDMI, Component, Composite, or Coax (RF). Based on your home theater configuration, you can decide which option is the right one for you. Refer to your set-top box user manual for more information about the video output requirements or consult your cable or satellite operator.



Using HDMI (Best)

Cable and Satellite Boxes that have a HDMI digital interface should be connected to the HDMI input of the HDTV for optimal results.

Note: To maintain the display quality, use a VIZIO certified HDMI cable. Length is available up to 10 meters. See www.vizio.com or call 1-888-VIZIOCE (1-888-849-4623) for details.

1. Turn off the power to the HDTV and HDTV Set-Top Box.
2. Connect an HDMI cable to the HDMI output of your HDTV Set-Top Box and the other end to the **HDMI 1** input at the rear of the HDTV.
3. Turn on the power to the HDTV and HDTV Set-Top Box.
4. Select **HDMI 1** using the **INPUT** button on the remote control, or directly by pressing the **HDMI** button on the remote control.

Note:

- The HDMI input on the HDTV supports High-bandwidth Digital Content Protection (HDCP). HDCP encrypts the transmission between the video source and the digital display for added security and protection.
- If you are already using the HDMI1 input for another device, or you do not want to use the HDMI1 input for the Set-Top Box, you can connect the Set-Top Box to another HDMI connection.
- Refer to your HDTV Set-Top Box user manual for more information about the video output requirements of the product or consult your cable or satellite operator.



HDMI Connections for Cable or Satellite Boxes with DVI

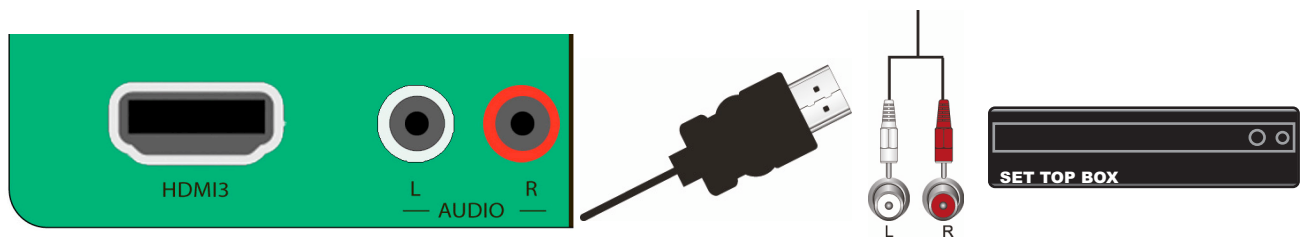

1. Turn off the power to the HDTV and HDTV Set-Top Box.
2. Using a HDMI-DVI cable, connect the DVI end to your HDTV Set-Top Box and the HDMI end to the **HDMI 3** input at the rear of the HDTV.
3. Using an audio cable, connect the cable to the audio output connectors associated with the DVI output on your HDTV Set-Top Box and connect the other end to the audio connectors associated with the HDMI input at the rear of the HDTV.
4. Turn on the power to the HDTV and HDTV Set-Top Box.
5. Select **HDMI 3** using the **INPUT** button on the remote control, or directly by pressing the **HDMI** button on the remote control.

Note:

- The HDMI input on the HDTV supports High-bandwidth Digital Content Protection (HDCP). HDCP encrypts the transmission between the video source and the digital display for added security and protection.
- Refer to your HDTV Set-Top Box user manual for more information about the video output requirements of the product or consult your cable or satellite operator.

Using Component Video (Better)

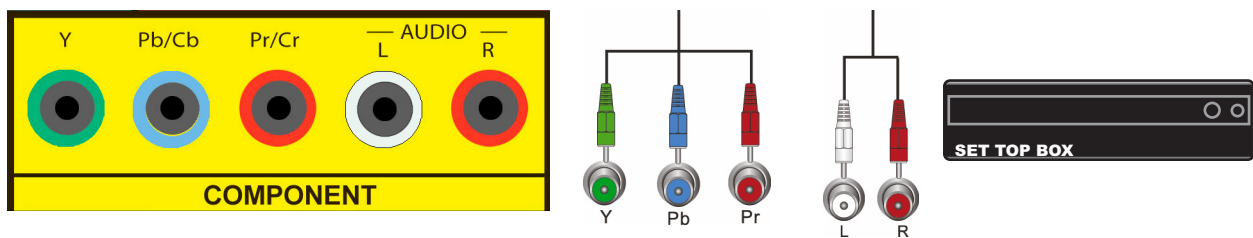

1. Turn off your HDTV and set-top box.
2. Connect the component cables (green, blue, and red) from your set-top box to the **COMPONENT** jacks on the back of your HDTV.
3. Connect the audio cables (white and red) from your set-top box to the adjacent **COMPONENT L** and **R Audio** jacks on the back of your HDTV.
4. Turn on your HDTV and set-top box.
5. Press **COMP** on the remote control to view the content.



Using S-Video (Compatible)

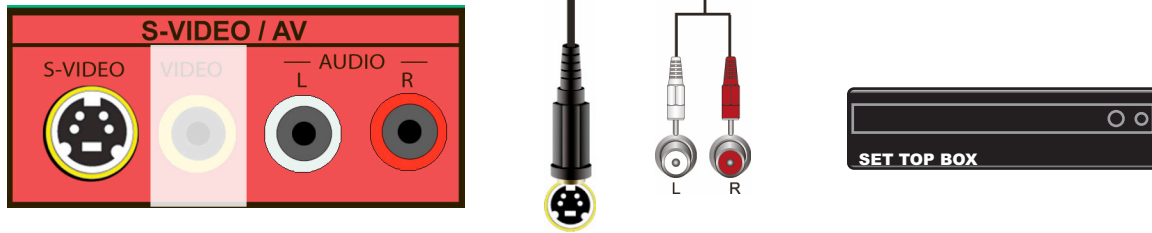

1. Turn off your HDTV and set-top box.
2. Connect the S-VIDEO cable from your set-top box to the **S-VIDEO** jack on the back of your HDTV.
3. Connect the audio cables (white and red) on your set-top box to the corresponding **L** and **R AUDIO** jacks on the back of your HDTV.
4. Turn on your HDTV and set-top box.
5. Press **AV** on the remote control to view the content.

Using Composite Video (Compatible)

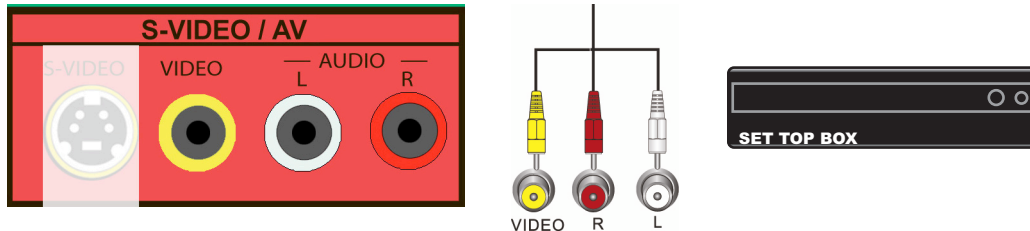

1. Turn off your HDTV and set-top box.
2. Connect the video cable (yellow) from your set-top box to the **AV** jack (yellow) on the back of your HDTV.
3. Connect the audio cables (white and red) on your set-top box to the corresponding **L** and **R AUDIO** jacks on the back of your HDTV.
4. Turn on your HDTV and set-top box.
5. Press **AV** on the remote control to view the content.

Using Coaxial (Antenna) (Compatible)



1. Turn off the power to the HDTV.
2. Connect the coaxial (RF) connector from your antenna or digital cable to the **DTV/TV CABLE/ANTENNA** connector at the rear of the HDTV.
3. Turn on the power to the HDTV.
4. Select TV using the **INPUT** button on the remote control, or directly by pressing the **TV** button on the remote control.



Connecting Coaxial (RF)

Using Your Antenna or Digital Cable for Standard TV or Digital TV



COAXIAL



1. Turn off the power to the HDTV.
2. Connect the coaxial (RF) connector from your antenna or cable to the **DTV/TV CABLE/ANTENNA** connector at the rear of the HDTV
3. Turn on the power to the HDTV.
4. Select TV using the **INPUT** button on the remote control, or directly by pressing the **TV** button on the remote control.

Using the Antenna or Cable through Your VCR



COAXIAL



1. Turn off the power to the HDTV and VCR.
2. Connect the "Output to TV", "RF Out" or "Antenna Out" connector on the rear of your VCR to the **DTV/TV CABLE/ANTENNA** connector at the rear of the HDTV.
3. Turn on the power to the HDTV and VCR.
4. Select TV using the **INPUT** button on the remote control, or directly by pressing the **TV** button on the remote control.

Note: If you have an off-air antenna or cable TV, connect it to the "Antenna In" connector on the rear of your VCR.



Connecting Your DVD Player

You have several options for connecting your DVD player to your HDTV: HDMI, Component, S-Video and Composite (AV) inputs. Based on your home theater configuration, you can decide which option is the right one for you.

Using HDMI (Best)



For optimal results, DVD players that have a digital interface such as HDMI should be connected to the HDMI input on your HDTV.

1. Turn off your HDTV and DVD player.
2. Connect a HDMI cable to the HDMI output of your DVD player and the other end to the **HDMI 1** input at the rear of the HDTV.
3. Turn on the power to the HDTV and your DVD player.
4. Select **HDMI 1** using the **INPUT** button on the remote control, or directly by pressing the HDMI button on the remote control.

Note: If HDMI 1 is being used, connect to another HDMI port instead.

HDMI Connections for DVD Players with DVI

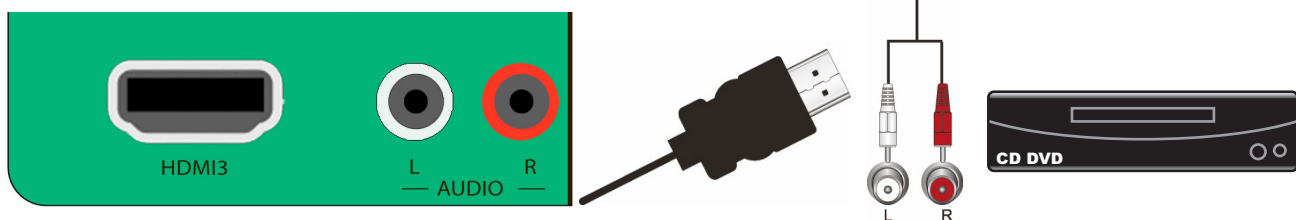

1. Turn off your HDTV and DVD player.
2. Using a HDMI-DVI cable, connect the DVI end to your DVD player and the HDMI end to the **HDMI 3** Input at the rear of the HDTV.
3. Connect the audio cables (white and red) from the DVI audio output jacks on the DVD player to the adjacent **HDMI 3 L** and **R AUDIO** jacks on the back of your HDTV.
4. Turn on the power to the HDTV and your DVD player.
5. Select **HDMI 3** using the INPUT button on the remote control, or directly by pressing the **HDMI** button on the remote control.

Note: To maintain the display quality, use a VIZIO certified HDMI cable. Length is available up to 10 meters. See www.VIZIO.com or call 1-888-VIZIOCE (1-888-849-4623) for details.



Using Component Video (Better)

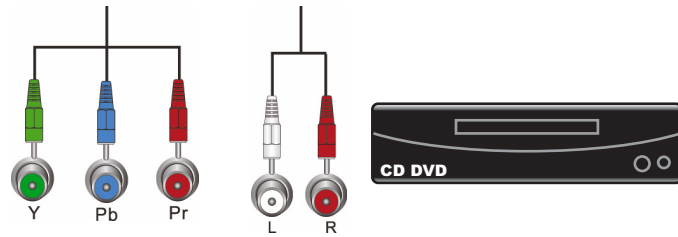
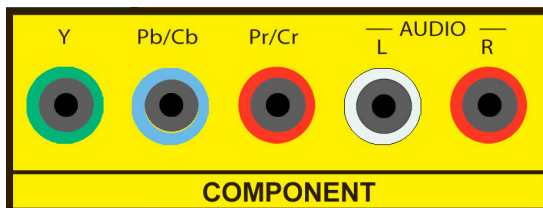

1. Turn off the power to the HDTV and DVD player.
2. Connect the component cable (green, blue, and red) from your DVD player to the **COMPONENT** jacks on the back.
3. Connect the audio cables (white and red) from your DVD player to the **COMPONENT L** and **R AUDIO** jacks on the back.
4. Turn on the power to the HDTV and DVD player.
5. Select **Component** using the **INPUT** button on the remote control, or directly by pressing the **COMP** button on the remote control.

Using S-Video (Compatible)

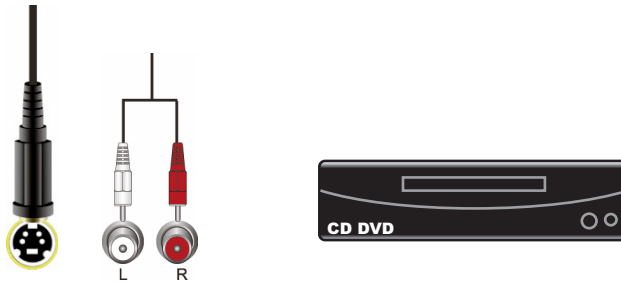
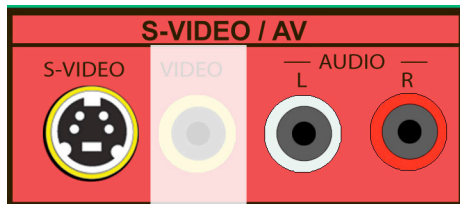

1. Turn off the power to the HDTV and DVD player.
2. Connect the S-VIDEO cable from your DVD player to the **S-VIDEO** jack on the back of your HDTV.
3. Using an audio cable, connect the cable to the audio output connectors associated with the S-Video output on your DVD player and connect the other end to the audio connectors associated with the AV input at the rear of the HDTV.
4. Turn on the power to the HDTV and DVD player.
5. Select **AV** using the **INPUT** button on the remote control, or directly by pressing the **AV** button on the remote control.



Using Composite (AV) Video (Compatible)

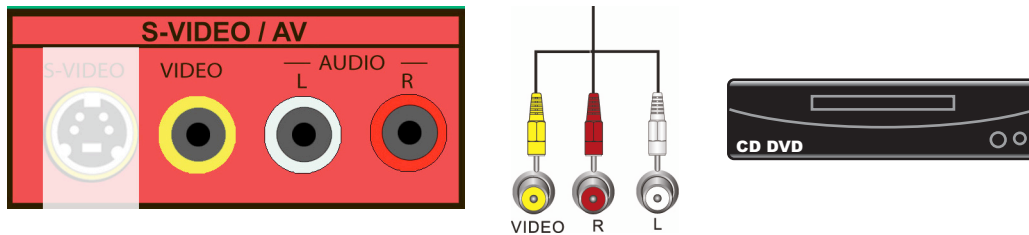

1. Turn off the power to the HDTV and DVD player.
2. Connect the Video cable (yellow) from your DVD player to the **S-VIDEO/AV** jack on the back of your HDTV.
3. Connect the audio cables (white and red) on your DVD player to the **S-VIDEO/AV L** and **R AUDIO** jacks on the back of your HDTV.
4. Turn on the power to the HDTV and DVD Player.
5. Select **AV** using the **INPUT** button on the remote control, or directly by pressing the **AV** button on the remote control.

Connecting Your VCR or Video Camera

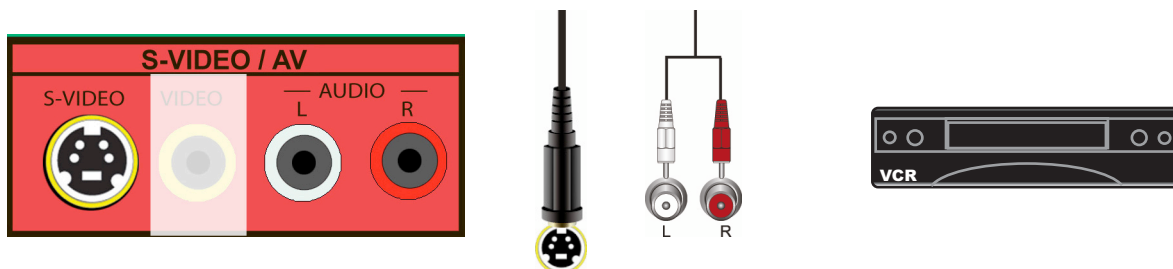

1. Turn off the power to the HDTV and VCR or Video Camera.
2. Connect the S-VIDEO cable from your VCR or video camera to the **S-VIDEO** jack on the back of your HDTV.
3. Connect the audio cables on your set-top box to the corresponding **L** and **R AUDIO** jacks on the back of your HDTV.
4. Turn on the power to the HDTV and VCR or Video Camera.
5. Select **AV** using the **INPUT** button on the remote control, or directly by pressing the **AV** button on the remote control.

Note: Refer to your VCR or Video Camera user manual for more information about the video output requirements of the product.



Connecting an External Receiver/Amp

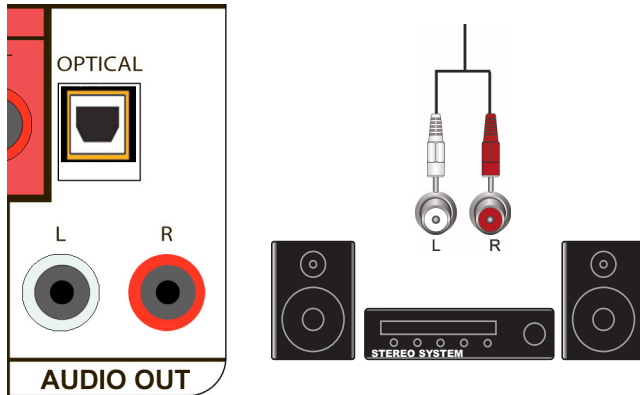

1. Turn off the power to the HDTV and Receiver/Amp.
2. Using an audio cable (white and red connectors), connect the cable to the audio input connectors on the Receiver/Amp and connect the other end to the **AUDIO OUT** audio connectors at the rear of the HDTV.
3. Turn on the power to the HDTV and Receiver/Amp.
4. Then press the **MENU** button on the remote control to open the On-Screen Display (OSD) menu.
5. Press **▼** on the remote control to highlight the Audio menu, then press **OK** to select.
6. Press **▼** on the remote control to select **SPEAKERS**.
7. Press **▶** on the remote control to select OFF so the sound from the HDTV will be routed through your Receiver/Amp system.



Note:

- Refer to your Receiver/Amp user manual to select the corresponding audio input.
- The audio output is not amplified and cannot be connected directly to external speakers.

Optical Output of audio received with HD Programs

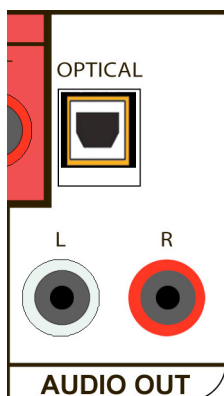

If your sound system has a SPDIF (optical) digital audio input you can connect it to the **OPTICAL** digital audio out at the rear of the HDTV. This is active when receiving audio with the programs being viewed no matter what input is being used.



Connecting a Computer

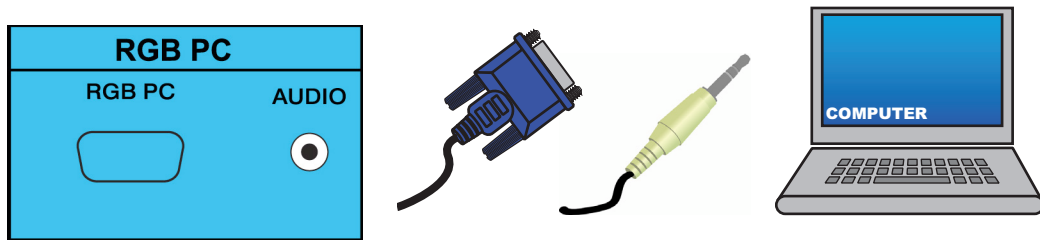

1. Turn off the power to the HDTV and Computer.
2. Connect the VGA cable from your computer to the **RGB PC** jack on the back of your HDTV.
3. Connect the 1/8-inch audio cable from your computer to the RGB PC **Audio** jack on the back of your HDTV. This step is optional and only needed if you want to transmit audio from the Computer through the TV.
4. Turn on the power to the HDTV and Computer.
5. Select **RGB** using the **INPUT** button on the remote control.

Note:

- For a better picture quality when connecting a PC computer through RGB PC, set your PC computer timing mode to VESA 1920 x 1080 at 60Hz.
- Refer to your PC computer user manual for more information about the video output requirements of the product.
- A RGB (VGA) cable and stereo mini jack cable are not included and can be purchased at an electronics store.

Preset PC Resolutions

If connecting to a PC through the RGB PC input, set the TV timing mode to VESA 1920x1080 at 60Hz for better picture quality (refer to the graphic card's user guide for questions on how to set this timing mode). See the table below for the factory preset resolutions. Also see Resolution through RGB Input chart below for the best resolution available through RGB PC input when video card supports 1920x1080 resolution.

Mode No.	Resolution	Refresh Rate (Hz)	Horiz. Freq (KHz)	Vert Freq (Hz)	Horiz Sync Polarity (TTL)	Vert Sync Polarity (TTL)	Pixel Rate (MHz)	Remark
1	640 x 480	60	31.469	59.941	N	N	25.175	Windows
2	640 x 480	75	37.500	75.000	N	N	31.500	Windows
3	800 x 600	60	37.879	60.317	P	P	40.000	Windows
4	800 x 600	72	48.077	72.188	P	P	50.000	Windows
5	800 x 600	75	46.875	75.000	P	P	49.500	Windows
6	1024 x 768	60	48.363	60.004	N	N	65.000	Windows
7	1024 x 768	70	56.476	70.069	N	N	75.000	Windows
8	1024 x 768	75	60.023	75.029	P	P	78.750	Windows
9	720 x 400	70	31.469	70.087	N	P	28.322	DOS
10	Ⓢ1920 x 1080	60	66.587	59.934	P	N	138.50	Windows

Note: P: positive, N: negative, Ⓢ: Primary mode

Resolution through RGB Input

If your PC supports VESA Reduced Blanking timing via the VGA card drive program (usually offered by the VGA Card Manufacturer), your TV set is equipped to have the 1920 x 1080 resolution display through this connection using the following timing 138.5MHz. The following parameters are often the values required by the software or programs to set up the display:

Parameters	Horizontal Values (Pixels)	Vertical Values (Lines)
Address	1920	1080
Front Porch	48	3
Sync Width	32	5
Back Porch	80	23
Total	2080	1111
Frequency	66.587 kHz	58.934 Hz
Sync Polarity	P	N
Pixel Rate (MHz)	138.5	
Refresh Rate (Hz)	59.934	



Chapter 3 Using the Media Port

With the Multimedia Viewer you can enjoy digital content such as photos, music, and movies on your HDTV using a USB flash drive connected to the Media Port on the left-hand side of the TV.

USB drives that are USB 2.0 and FAT or FAT32 are supported but the Media Port does not support hard drives or USB hubs.

If your USB drive is oversized and does not physically fit in the Media Port, use a USB extension cable. Connect one end of the cable to your USB drive and the other end to the Media Port.

Multimedia Viewer Specifications	
Supported File Extensions	Video: .asf, .wmv, .avi, .mp4, .mov, .mpg, .mpeg, .vob (DVD) Audio: .mp3 Image: .jpg, .jpeg (up to 17,000 x 10,000 pixels)
Readable Data Format	FAT and FAT32
Maximum folder depth	Folders can be up to 20 levels deep. The first folder on the drive is Level 1. A folder within that folder is Level 2, a folder within that folder is Level 3, etc.
Display Limits	The Multimedia Viewer will show the first 1000 folders and 1000 files in the list

Supported File Formats





The following are the supported file formats that can be played on your HDTV. Media server content protected by digital rights management such as WMDRM10 (Windows Media Digital Rights Management 10), may not play.

File Extension	Video Encoders Supported	Audio Encoders Supported	Resolutions Supported
.avi	H.264/AVC	AAC	Up to 1920 x 1080
.mp4	MPEG 4 ASP	AAC	Up to 1280 x 720
.asf .wmv	WMV7 (WMV1) WMV8 (WMV2) VC-1/WMV9 (WMV3/WVC1)	WMA7(V1) WMA8(V2)	Up to 1920 x 1080
.mov	H.264/AVC	AAC	Up to 1920 x 1080
.mpg .mpeg	MPEG2	AC3	Up to 1920 x 1080
.vob	MPEG2	AC3	Up to 1920 x 1080

Note: Even the supported format files listed above may or may not play properly or completely, depending on the USB device, bit rate stream and other content characteristics, as well as other factors.



Viewing Multimedia Content

1. Insert a USB device with digital content such as photos, music, and movies into the Media Port on the left-hand side of your HDTV. If a USB device is already connected, press the **MEDIA** button on the remote control. A message will appear asking if you want to play multimedia content.
2. Press ◀ or ▶ to highlight OK, and then press **OK** to select it.
3. Press ◀ or ▶ to highlight the folder that contains the content you want to see or hear, and then press **OK** to select it. A sub-menu will be displayed, showing the folders and files that are on your USB device.
4. Press ◀ or ▶ to highlight the folder or file you want to play, and then press **OK** to select it. The file will be playing.
5. While playing videos or music, fast forward or fast reverse by pressing ◀ or ▶.
 - a. Press ◀ or ▶ to increase the playback speed forward or reverse 2X. The display at the bottom will show  or .
 - b. Press ◀ or ▶ again to increase the playback speed forward or reverse 4X, 8X, 16X, or 32X. The display at the bottom will show  or .
 - c. Press ◀ or ▶ again to resume normal playback.
6. When finished, press EXIT once to return to the previous screen or repeatedly to return to the main menu.

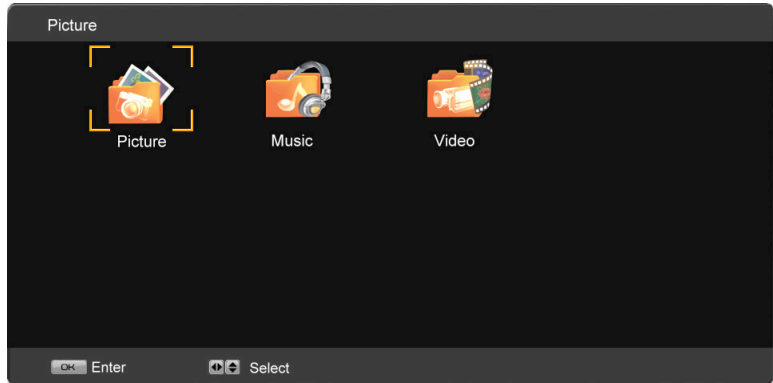
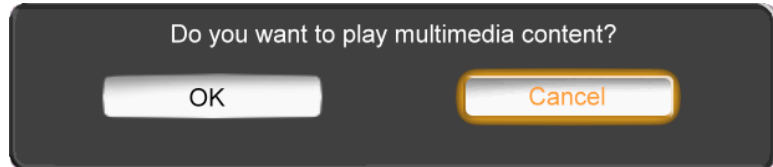

Picture Settings

When viewing pictures you can adjust various settings, including slideshow, picture duration, etc.

1. Insert a USB device and select the Picture Folder.
2. Press the **MENU** button on the remote control. The Picture menu will be displayed.
3. Press **▲** or **▼** on the remote control to highlight Picture menu option, and then press **◀** or **▶** to adjust the setting.
4. Press the **MENU** button once to close the menu.

Slideshow Mode

Choose from Shuffle, Single, and Sequence to set the slideshow mode. Single will show all of the pictures once and stop the slideshow after displaying the last picture, Sequence will show your pictures in the order they are listed on your USB device until you stop the slideshow, and Shuffle will show your pictures in random order until you stop the slideshow.

Press **OK** to begin the slideshow. Press **EXIT** to stop the slideshow.

Slideshow with Music

Choose from Off, Single, Sequence, and Shuffle to set the slideshow with music mode. The music will automatically stop when the slideshow stops.

Press **OK** to begin the slideshow. Press **EXIT** to stop the slideshow.

Music file browser

Select the slideshow music. Press **OK** to browse for music on your USB device that you want playing during the slideshow. The *Slideshow with Music* option above must be set to Single, Sequence, and Shuffle for this option to work.

Audio Mode

Choose from Flat, Rock, Pop, Classic, or Jazz to adjust the overall quality of the audio being played during the slideshow. Press **OK** to enter the Audio sub menus for additional adjustments to audio. See Audio Menu adjustment on page 42. Turn SRS TruVolume Off when listening to music.

Repeat

Choose from On or Off to repeat the slideshow.

Sort By

You can choose to sort the pictures on the USB device by Photo Date, File Date, or alphabetically (File A-Z).

Duration

Set the amount of time the picture will remain on the screen during the slideshow. Choose a time between 5 seconds and 32 seconds.

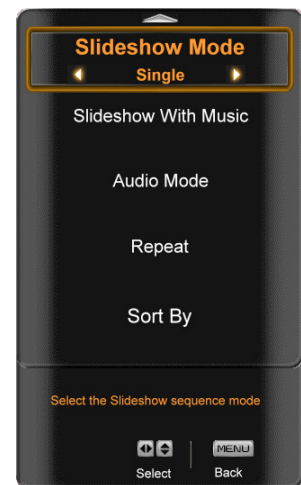

Slideshow Effect

Choose from Random, Dissolve, Wipe Right, Wipe Left, Wipe Up, Wipe Down, Box In, or Box Out to set the transition type when changing from one picture to another during a slideshow.

Thumbnail Size

Set the size of the preview pictures (thumbnails) in the menu. Choose from Small, Medium, or Large.

Info

When set to on, information about the picture briefly appears on the TV.

Music Settings

When listening to music you can adjust various settings, including selecting an audio mode, choosing repeat options, etc.

1. Insert a USB device and select the Music Folder.
2. Press the **MENU** button on the remote control. The Music menu will be displayed.
3. Press **▲** or **▼** on the remote control to highlight Music menu option, and then press **◀** or **▶** to adjust the setting.
4. Press the **MENU** button once to close the menu.

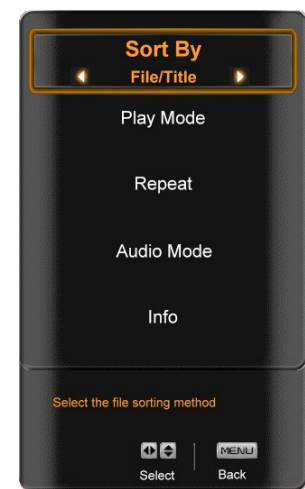

Sort By

You can choose to sort the songs by File/Title, Genre, Artist, or Album.

Play Mode

Choose from Shuffle, Single, and Sequence to set the play sequence mode. Single will play a single song once and stop playing at the end of that song, Sequence will play the songs in the order they are listed on your USB device until you stop it, and Shuffle will play the songs in random order until you stop it.

Repeat

When set to On, the music will continue playing until you stop it.

Audio Mode

Choose from Flat, Rock, Pop, Classic, and Jazz to adjust the overall quality of the audio being played.

Info

When set to on, information about the song briefly appears on the TV.



Video Settings

When watching videos you can adjust various settings, including selecting an audio mode, setting to a wider format, etc.

1. Insert a USB device and select the Video Folder.
2. Press the **MENU** button on the remote control. The Video menu will be displayed.
3. Press **▲** or **▼** on the remote control to highlight Video menu option, and then press **◀** or **▶** to adjust the setting.
4. Press the **MENU** button once to close the menu.

Sort By

You can choose to sort the videos by Type, Date, or, File Name.

Play Mode

Choose from Shuffle, Single, and Sequence to set the video sequence mode. Single will play a video once and stop playing at the end of that song. Sequence will play the videos in the order they are listed on your USB device until you stop it. Shuffle will play the videos in random order until you stop it.

Repeat

When set to On, the video(s) will continue playing until you stop it.

Picture Mode

Choose from Custom, Standard, Movie, Game, Vivid, Football, Golf, Basketball and Baseball to adjust the overall quality of the picture. Press **OK** to enter the Picture sub menus for additional adjustments to audio. See Picture Menu adjustment on page 40.

Wide Format

Set the way the picture looks on the screen:

- 4:3 Aspect Ratio: choose from Normal, Panoramic, Zoom1, or Zoom2.
- 16:9 Aspect Ratio: choose from Full, Stretch, Zoom1, and Zoom2

Audio Mode

Choose from Flat, Rock, Pop, Classic, Jazz, and Soft to adjust the overall quality of the audio being played.

Info

When set to on, information about the video briefly appears on the TV.



Chapter 4 Using your HDTV the first time

Setup Wizard

1. **Connect the Power Cable**
Connect the power cord to the power cord connector on the back of the HDTV, and then plug the power cord into an AC wall socket.
2. **Connect Audio and Video Cables to the HDTV**
(see Chapter 2 for detailed steps)
3. **Turn Power On**
Once all the components are connected, press the Power ON button on the remote control or on the side of your HDTV.
4. **Initial Setup**
 - a. After powering on the TV set, the *Initial Setup Welcome* screen will come up. Press the **OK** button on the remote control.
 - b. The *Language* choice screen will be displayed; the default English option is highlighted. If you wish to change the OSD language to Español or Français, press the ▼ button on the remote control to select the language you want.
 - c. Press the **OK** button on the remote control to go to the next screen.
 - d. The next screen will display the options **Home Mode** and **Retail Mode**. Selecting Home Mode will give you an opportunity to save energy.
 - e. Press the **OK** button on the remote control to go to the next screen.
 - f. If **Retail Mode** is selected by mistake; the next option will allow you to switch your selection back to **Home Mode**.
 - g. Press the **OK** button on the remote control to go to the next screen.

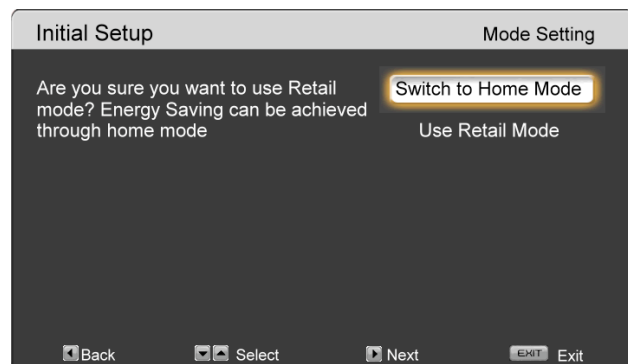
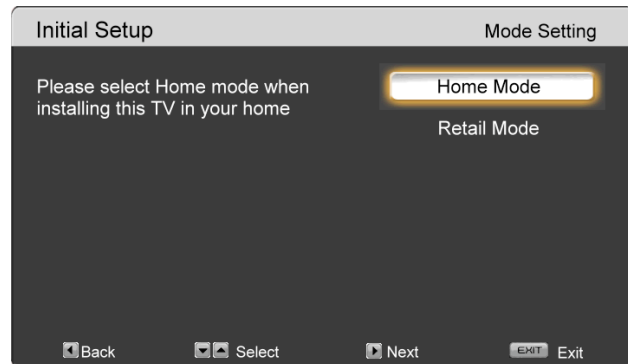
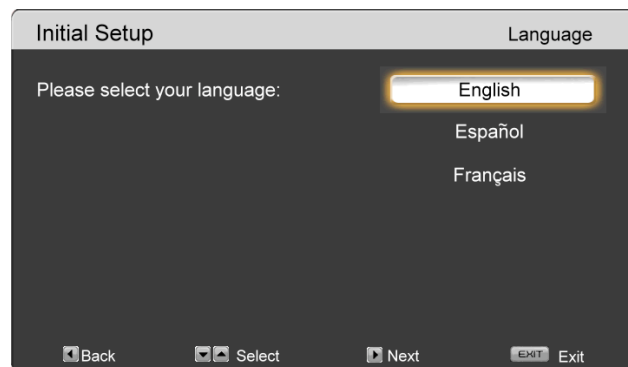
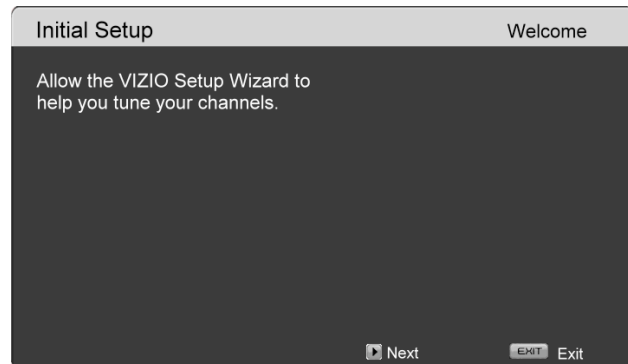

Note: At this point, if a set-top box from your cable or satellite service company is being used, press the **OK** button on the remote control and select *Skip Scan*. Otherwise continue with next step:

- h. The *Tuner* screen will be displayed. If you are using Cable Service (with no box), press the **▼** button on the remote control to choose **CABLE**.
- i. Press the **OK** button on the remote control to go to the next screen.
- j. The *Channel Scan* screen will be displayed; default choice is Scan.
- k. Press the **OK** button on the remote control to start the search for available channels.
- l. If you do not want to scan for channels at this time, press the **▼** button on the remote control to highlight *Skip Scan* and then press the **OK** button. The screen will now change to show the progress of the search for Analog (NTSC) and Digital (ATSC) channels.

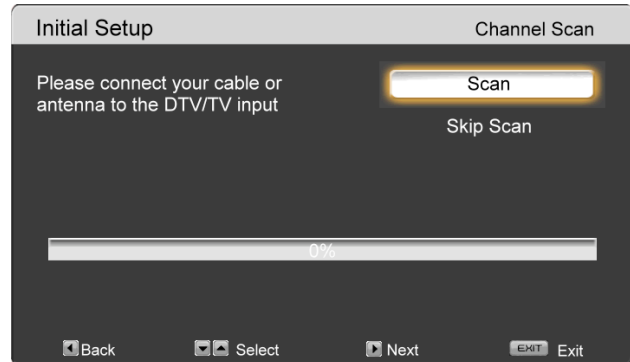
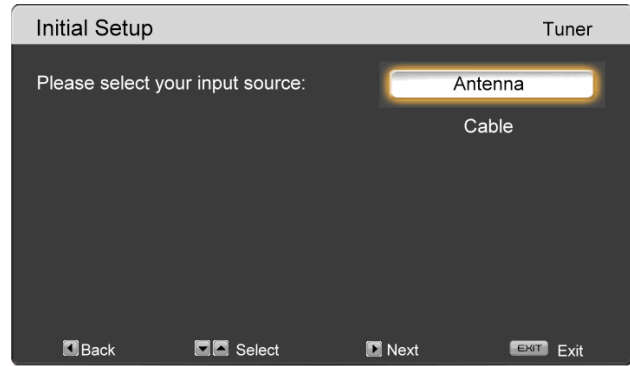

Note: If you select Skip Scan, you can scan channels at a later time by selecting the TV input, then going to the Menu and selecting the Auto Search option in the TV menu.

Note: Refer to www.antennaweb.org to get information about availability in your area, type of antenna and in which direction to point your antenna. The channel availability through cable depends upon which channels your cable operator supplies in Clear QAM; consult your cable operator for more information.

- m. When finished, the *Complete* screen will be displayed to inform you that the HDTV has completed the Initial Setup. Press the **OK** button on the remote control to exit and begin watching TV.

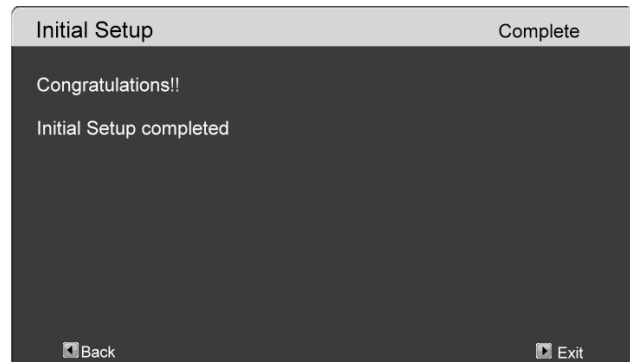
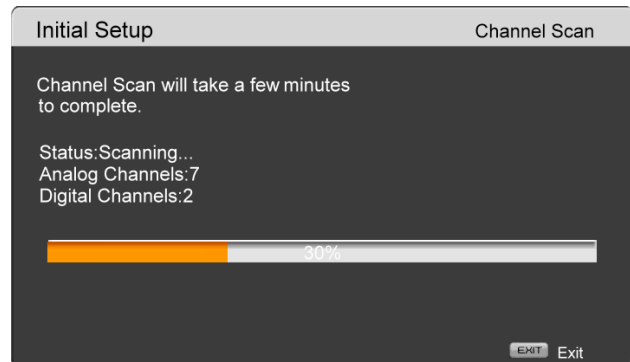

Select Input Source

Select the Input Source for the HDTV by pressing the **INPUT** button on the remote control. Pressing this button will cycle you through the following options: TV, AV, Component, RGB, HDMI1, HDMI2, and HDMI3.

Turn on your Cable Box, VCR, External TV Tuner or Satellite Receiver and you will see a picture on your HDTV. If there is no picture, make sure you have selected the correct input on the HDTV.

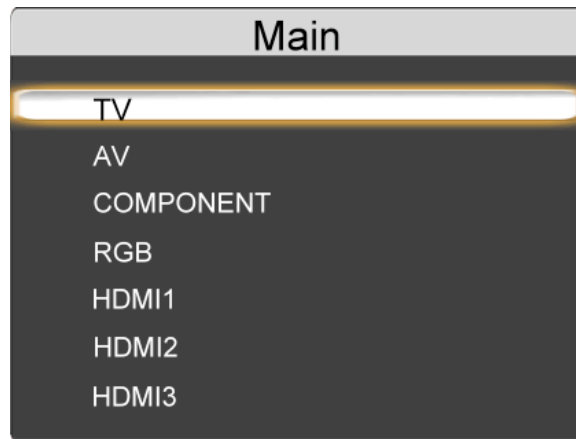

If the selected input is RF, you should be aware that the HDTV needs to be on either channel 3 or channel 4 matching the channel which has been selected on the back of the VCR, Cable Box, External TV Tuner or Satellite Receiver; please refer to Owner or User's Manual of such equipment for details.

Note: Your HDTV will display the television station or program selected by the cable box, VCR, external tuner, or satellite receiver. Use the remote control that came with that component to change programs or channels. If the service being used is the one which setup includes a box with two outputs for two different (distant) rooms, then scanning channels will help you to find the signal. Be aware that the channel to be selected varies from provider to provider. You may have to call your provider to get the specific channel when using your HDTV. Some examples of these channels are 105, 106, 115, and 116.



Fine Tuning the picture

1. Press the **MENU** button to bring up the Menu display. The Picture Menu is highlighted. Press **OK** to select it. Use the **▲** or **▼** buttons to scroll to the Advanced Video option.
2. Press the **▶** button to select it.
3. Use either **▲** or **▼** to scroll to the Color Temperature option.
4. Press the **▶** button to select it.
5. Press either **◀** or **▶** to change setting to **Normal**, and then press the **MENU** button repeatedly until the Picture Mode is displayed.
6. Press either **◀** or **▶** to change the Picture mode option to **Standard**.
7. Press either **▲** or **▼** to scroll to the TV option, and then press **OK** to select it.
8. Press either **▲** or **▼** to scroll to Time Zone, and then press either **◀** or **▶** to set the proper Time Zone of your area.
9. Press **▼** to scroll down to Daylight Saving, and then press either **◀** or **▶** to set to On or Off.
10. Press the **MENU** button once to return to the previous screen or repeatedly to return to your program if task has been completed.

Your new HDTV is now ready to use. Enjoy your TV watching!!

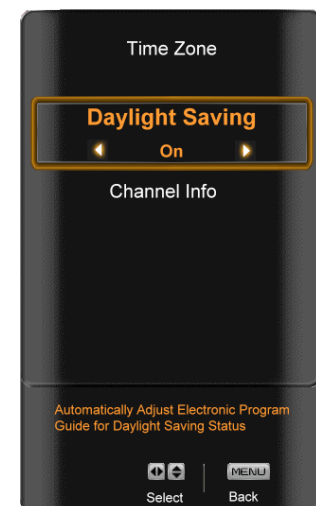
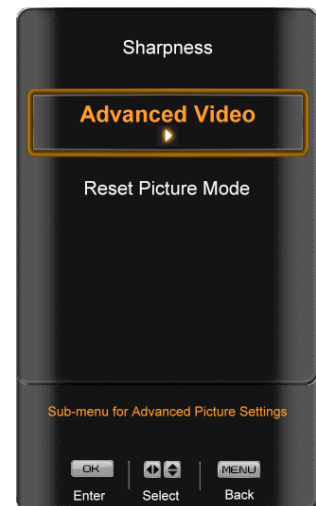

Watching a TV Program

Before you start watching TV, please make sure that any cable, satellite or off-air antenna connections are secure. Also, verify that the power cord is plugged into a correctly grounded electrical outlet or surge protector.

1. Press the power button on the remote control. The VIZIO logo on the front will change from orange to white.
2. There are 3 options for selecting your programming:
 - a. If you are using an antenna or cable connected through the DTV/TV CABLE/ANTENNA input, you can select TV directly by pressing the **TV** button on the remote control or by selecting TV from the Input menu after pressing **INPUT** on the remote control.
 - b. If you are watching broadcasts through a cable or satellite set-top box connected by an HDMI cable, select HDMI directly by pressing the HDMI button on the remote control, or by selecting HDMI from the Input menu after pressing **INPUT** on the remote control.
 - c. If you are watching broadcasts through a cable or satellite set-top box connected by a Component (YPbPr) cable, select Component directly by pressing the **COMP** button on the remote control or by selecting Component from the Input menu after pressing **INPUT** on the remote control.

Note: You should be able to see a picture. If you do not, make sure that all of the HDTV connections are secure and you have selected the correct video input source. Each press of the **HDMI** or **COMP** button on the remote control will cycle through the available inputs. Press the button until the input associated with the device you wish to view is shown in the Info box at the upper right corner of the screen.

3. When using option 2a, press the Channel buttons on the remote control or the CH **▲** or **▼** buttons to change the channel. The Channel buttons and on the remote control, control will not work if you are watching a program using HDMI, Component, or AV (S-Video or Composite) inputs.



Adjusting Basic HDTV Settings

Volume

To adjust the volume, press and hold the VOL+ or VOL- button or remote control until the desired level is reached.

TV Channels

To step up or down through the available TV channels, press the CH ▲ or ▼ button on the remote control once for the next or previous channel, or hold it depressed until the desired channel is reached. *Note: Channel up and down will only operate in TV mode.*



Program Information

When watching a digital TV program, the On Screen Display will function as follows:

- When a channel is selected, an information header is shown over the picture for a few seconds.

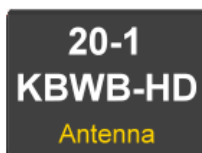

- When you press the **GUIDE** button on the remote control, the information header and a short summary of the program content, when available from the broadcaster, is displayed.

Charmed 10:00PM-11:00PM TV-14-V	English Stereo 1080i HD	20-1 KBWB-HD Antenna
Zanku taps the services of the insidious Alchemist (John Kassir) to weaken the nerves of the sisters in a poly to gain control of the Book of Shandows. Meanwhile, Darryl struggles to keep Insp. Sheridan (Jenya Lano) in the dark about the Charmed Ones. Zan		

This information consists of the channel number and name, the format in which the program is broadcast (480i SD, 480P SD, 720P HD, 1080i HD), audio channel 1/2 or 2/2 (omitted if alternate channel is not broadcast), language, program title, program start and end time, program rating and if CC is available.

- Press the **GUIDE** button one more time to close the display



Chapter 5 Advanced Adjustment of HDTV

Using the On Screen Display (OSD)

The remote control can control all the function settings. The On Screen Display (OSD) allows you to adjust contrast, brightness and other settings. The TV will save changes made to the settings, even if the TV is turned off.

The OSD consists of several menu options: Picture, Audio Mode, TV, and Setup. The main menu options may vary depending on your selected input source.

Note: Some of the main menu options may have additional submenus, for example, the TV Rating submenu for Parental Controls.

1. Press the **MENU** button on the remote control and the Picture menu will be shown on the screen.
2. Press either **▲** or **▼** on the remote control to select one of the other menu options:
 - Picture (Picture Adjust)
 - Audio Mode (Audio Adjust)
 - TV (TV Tuner Setup)
 - Setup (Global Settings)
3. Press **OK** to select the option or feature you want to adjust.
4. Once the menu option is displayed, press **▲** or **▼** on the remote control to select one of the items to adjust.
5. Press **OK** to select, and then press **◀** or **▶** to adjust the selection.
6. Press the **MENU** button once to return to the previous screen or repeatedly to return to your program if adjustments have been completed.



Picture Menu

1. Press the **MENU** button on the remote control.
2. Press **▲** or **▼** on the remote control to highlight the Picture menu, and then press **OK** to select it.
3. Press **▲** or **▼** on the remote control to select a Picture menu option.
4. Once the menu option is highlighted, press **◀** or **▶** on the remote control to adjust the setting.
5. Press the **MENU** button once to return to the previous screen or repeatedly to return to your program if the task has been completed.

Picture Mode

Choose from Custom, Standard, Movie, Game, Vivid, Football, Golf, Basketball and Baseball.

Backlight

The Backlight level adjusts the lamp current and this affects the overall brilliance of the picture but does not affect the Brightness (black level) or Contrast (white level) of the picture.

Brightness

The Brightness adjusts the black levels in the picture. If the brightness is too low you will not be able to see the detail in darker parts of the picture and if the brightness is too high the picture will look washed out.

Contrast

The Contrast adjusts the white levels in the picture. If the contrast is too low the picture will look washed out and if the contrast is too high you will not be able to see any detail in the bright parts of a picture.

Color

Color adjusts the amount of color in the picture.

Tint

The Tint adjusts the hue of the picture. The easiest way to set tint is to look at flesh tones and adjust for a realistic appearance. In most cases, the default middle position is correct. If people's faces look too orange try reducing the level of color first.

Sharpness

The Sharpness adjustment adjusts the sharpness of the edges of elements in the picture. It does not produce detail that otherwise does not exist. This adjustment is helpful when viewing (Standard Definition) sources.

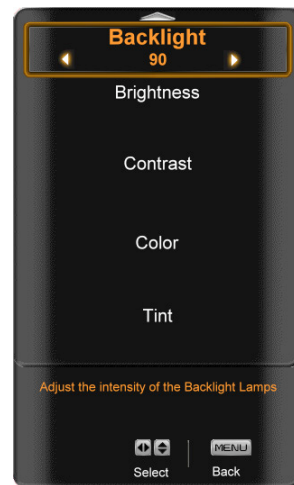

Advanced Video

To select the options in the Advanced Video sub-menu, press the **OK** button or the **▶** button. A new menu will be displayed showing the advanced functions available for fine tuning of the picture.

Noise Reduction

This feature diminishes picture artifacts caused by the digitizing of image motion content that may be present in the picture. Choose from the Off, Low, Medium, or Strong setting.

Color Enhancement

This feature increases the picture reproduction performance of the picture by reducing oversaturation of certain colors and improving flesh tones. Choose from Off, Normal, Rich Color, Green/Flesh, and Green/Blue setting.

Advanced Adaptive Luma

Large areas of brightness in the picture will result in a higher Average Picture Level (APL) and the overall picture will look too light. This feature will lower the APL to counteract this effect. Choose from Off, Low, Medium, Strong, or Extend.

Backlight Control

Set this feature to OFF, DCR, or OPC. DCR (Dynamic Contrast Ratio) improves the black level performance and increases contrast ratio. OPC (Optimum Power Control) Reduces power consumption while maintaining the same picture brightness.

Color Temperature

Color Temperature is the “warmness” or “coolness” of the white areas of the picture. Choose from Normal, Custom, Cool, or Computer. Normal is the setting for television broadcasting. Custom allows you to set a preset calibrated for a white point to suit individual preferences. Cool produces a blue-hued image. The Computer setting sets the white point at the established setting for a PC display (9300K). Each preset may also be adjusted for a customized setting.

Smooth Motion

The Smooth Motion™ Effect option activates Motion Estimation/Motion Compensation (ME/MC), which suppresses motion judder, or “stuttering” of the image when the camera pans across a scene, or there is horizontal motion in the scene. Choose from Off, Low, Middle or High.

Film Mode

Choose from Auto or Off. When set to Auto, the TV will detect the cadence (for example at 24 frames/second for film, or normal video at 60 fps). When set to Off it will stay at 60 fps.

Reset Picture Mode

Return all Picture settings to factory default. A screen will come up to confirm your selection or to cancel it. Press either **◀** or **▶** to make the selection, and then press **OK** to accept it.

Note: Only settings under the Picture menu will be reset.



Audio Menu

1. Press the **MENU** button on the remote control and the Picture menu will be shown on the screen.
2. Press **▲** or **▼** on the remote control to highlight the Audio menu, and then press **OK** to select it.
3. Press **▲** or **▼** on the remote control to select an Audio menu option.
4. Once the menu option is highlighted, press **◀** or **▶** on the remote control to adjust the setting.
5. Press the **MENU** key once to return to the previous screen or repeatedly to return to your program if the task has been completed.

Audio Mode

Choose from Flat, Rock, Pop, Classic or Jazz.

Equalizer

To select the options in the Equalizer sub-menu, press the **OK** button. A new menu will be displayed showing the volumes of different frequencies (pitches).

Starting from lowest to the highest pitch, they are 120 Hz, 500Hz, 1.5 kHz, 5 kHz and 10 kHz.

1. Press **◀** or **▶** to select the frequency to be adjusted.
2. Use **▲** or **▼** to adjust to adjust the selected frequency to your preference. Values above 0 will boost the frequency and values below 0 will attenuate the frequency.



Note: The Equalizer adjustment will only be available when SRS TSHD is set to Off.

Balance

Adjust the sound to the left or the right.

SRS TSHD

This option sets the SRS TruSurround HD surround sound process. Choose from On or Off.

Note: When SRS TSHD is ON, Equalizer adjustments are not available.

SRS TruVolume

When the programming switches to a commercial or when changing from channel to channel, volume fluctuations occur. When turned ON, SRS TruVolume™ provides the listener with a comfortable and consistent volume level. Turn this option Off when listening to music.

Digital Audio Out

This option allows selection of the type of processing for the SPDIF (Optical connector) when used with a Receiver/Amplifier/Home Theater system. Select to choose from OFF, Dolby Digital or PCM.

Speakers

Turn the internal speakers On or Off. You may want to turn the internal speakers off when listening to the audio through your Home Theater System.



Analog Audio Out

This option sets the volume control properties when using the RCA (white and red) connectors as audio line out to connect a Receiver/Amplifier/Home Theater system. Choose from Fixed or Variable. When set to Variable, volume from the external speakers will change according to the volume setting on the TV. If it is set to Fixed, the volume can only be changed by the settings on the external stereo system.

Lip Sync

Lip Sync is designed to adjust the audio of the program being viewed so that it matches the movement of the lips of someone talking on the screen.

Reset Audio Mode

Return all Audio settings to factory default. A screen will come up to confirm your selection or to cancel it. Press ◀ or ▶ to make the selection, and then press **OK** to accept it.

Note: Only settings under the Audio menu will be reset.

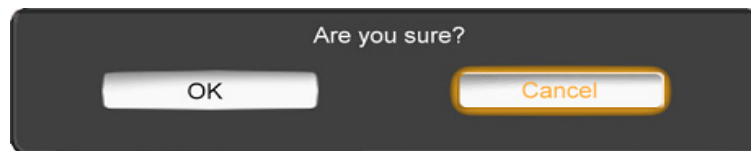

TV Menu

When you first turned on your HDTV you set up your TV for DTV / TV channels using the Initial Setup screens. If you did not do this or if your setup has changed, you can do this from the TV menu.

1. Press the **MENU** button on the remote control and the Picture menu will be shown on the screen.
2. Press **▲** or **▼** on the remote control to highlight the TV menu, and then press **OK** to select it.
3. Press **▲** or **▼** on the remote control to select a TV menu option.
4. Once the menu option is highlighted, press **◀** or **▶** on the remote control to adjust the setting.
5. Press the **MENU** key once to return to the previous screen or repeatedly to return to your program if the task has been completed.

Tuner Mode

Select Cable or Antenna depending upon which equipment you have attached to the DTV / TV Input.

Auto Search

Automatically search for TV channels that are available in your area. The TV will search for analog and digital channels.

Partial Channel Search

If you believe channels are missed from the auto search, you can do a partial channel search to look for channel in a certain channel range again. Select to scan for Analog, Digital, or both Analog/Digital channels, then press the **▼** button to highlight the "From" and "To" selection. Press the **▶** button to select the range of channel numbers you want to start searching in. Press **OK** to start channel search.

Skip Channel

After the TV has stored all of the available digital channels in memory you will find that some channels are too weak to watch comfortably or they may be channels you do not want to see. Press the **OK** button to select the channel to be skipped when using the **CH▲** or **CH▼** buttons. You will still be able to select this channel using the number buttons on the remote control.

MTS

This feature allows you to select the different languages the broadcaster is transmitting the audio with the program you are watching. This signal is usually Spanish.

Time Zone

Setting the correct Time Zone for your area will ensure that the correct program times are shown after pressing the **INFO** button on the remote control.

Daylight Saving

Setting the daylight saving time for your area will ensure that the correct program times are shown after pressing the **INFO** button on the remote control.

Channel Info

Channel Info displays the technical information of the channel including channel number, frequency, modulation type, status, SNR (signal noise ratio), and signal strength.

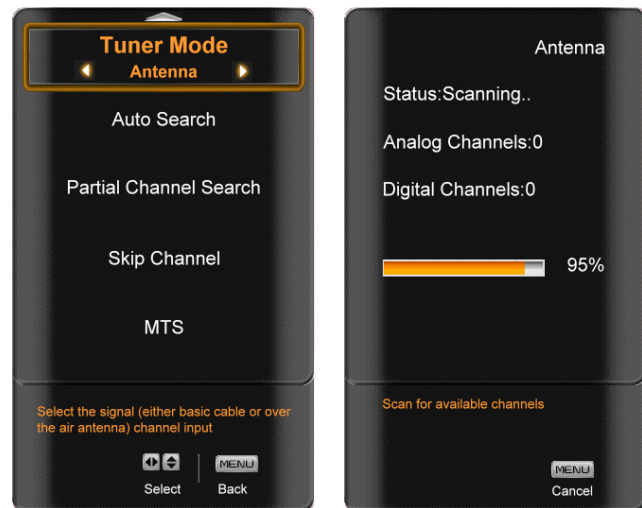

Setup Menu

1. Press the **MENU** button on the remote control and the Picture menu will be shown on the screen.
2. Press **▲** or **▼** on the remote control to highlight the Setup menu, and then press **OK** to select it.
3. Press **▲** or **▼** on the remote control to select an Input menu option.
4. Once the menu option is highlighted, press **◀** or **▶** on the remote control to adjust the setting.
5. Press the **MENU** key once to return to the previous screen or repeatedly to return to your program if the task has been completed.

Language

Select to change the Language of the OSD. The default is English. You can also select Español or Français.

PIP

Your TV features PIP mode so you can watch two pictures at the same time. One picture is displayed as the full screen (main screen) and the other picture is displayed in a small window (sub screen).

Note: PIP is only available when the Rating Enable option in the Parental Controls Menu is OFF.

To select the options in the PIP sub-menu, press the **OK** button. A new menu will be displayed showing the following PIP settings:



PIP Mode

Select from Off, PIP or POP (Picture-outside picture). In PIP mode a smaller sub-screen is displayed on top of the main screen. In POP mode the main screen and sub-screen are of equal size and are positioned side-by-side.



PIP Source

Select the input source for the sub-screen. The input sources available will vary according to which input is used for the main screen.

MAIN \ SUB	SUB					
	DTV	TV	AV	Component	HDMI1, HDMI2, HDMI3	RGB
DTV				✓	✓	✓
TV				✓	✓	✓
AV				✓	✓	✓
Component	✓	✓	✓		✓	
HDMI 1	✓	✓	✓	✓		✓
HDMI 2	✓	✓	✓	✓		✓
HDMI 3	✓	✓	✓	✓		✓
RGB	✓	✓	✓		✓	

“✓” – Indicates which inputs are available for PIP and POP modes.

PIP Position

Select where you want the PIP screen positioned over the main screen.

Size

Set the size of the PIP window. Choose from Small, Medium or Large.

Audio Source

Select the audio source associated with the main screen or the sub screen.

CEC Menu

Consumer Electronics Control (CEC) allows you to control devices that are connected through HDMI, such as a Blu-ray DVD player, with just one remote control.

- When the TV is turned off, all HDMI-CEC devices will turn off automatically.
- When an HDMI-CEC device is turned on, the TV will turn on automatically.

CEC Function

Select whether to allow the TV to control the HDMI-CEC device. Choose Enable (On) or Disable (Off).

Device Discovery

Search for all available HDMI-CEC devices connected to the TV.

Sleep Timer

Select the timer to turn off the TV in 30, 60, 90 or 120 minutes.

Wide

Select how the picture displays on the screen. As you select an option, you will see the screen adjusting to the different sizes. Refer to Understanding Viewing Features for additional details.



Input Naming

This feature helps you identify the input being watched. You can use up to 8 characters; either letters or numbers or combinations of both, to add a name that will make it easier for you to recognize the input.

1. Press the ► button to go to the next screen that shows the different inputs.
2. Press the ▼ button to select the desired input which you want to label.
3. Press the **OK** button to go to the first space in the bracket.
4. Press either the ▲ or ▼ button and select a desired letter or number.
5. Press the ► button to go to the next space and select a second character.
6. Repeat the step 4 and 5 until the name of the input is complete.
7. Press the **OK** button to accept the name of the input or the **MENU** key to cancel the setting.



CC (Closed Caption)

To select the options in the CC sub-menu, press the **OK** button or the ► button. A new menu will be displayed showing the following CC settings:

CC

The CC feature is available when watching regular analog (NTSC) TV. Select from CC1, CC2, CC3, CC4, Service1, Service2, Service3, Service4, Service5, or Service6. Closed Caption for regular TV is usually CC1 or CC2.

Digital CC Style

The Digital CC Style feature is available when watching digital TV. Select either As Broadcaster or Custom. If Custom is selected then you can customize the way Closed Caption is displayed. The options available are:

- **Font Size** (letter size)
- **Font Color** (letter color)
- **Font Opacity** (letter transparency)
- **Background Color** (color of the background where Closed Caption is displayed)
- **Background Opacity** (sets the transparency of the background)
- **Window Color** (color of the area where characters are displayed)
- **Window Opacity** (transparency of the area where characters are displayed)



H/V Position

To select the options in the H/V Position sub-menu, press the **MENU** button or the ► button. A new menu will be displayed showing the following H/V Position settings:

H-Position

Adjust the horizontal position of the picture.

V-Position

Adjust the vertical position of the picture.

H-SIZE

Adjust the horizontal size of the picture.

V-SIZE

Adjust the vertical size of the picture.

Auto Phase (for Component input only)

The TV will automatically look for the phase of the signal to fine tune the picture.

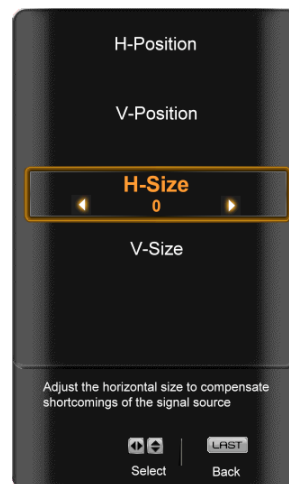

Parental

If you want to restrict certain channel and program viewing, you can do this by turning on the Parental Control. Selected programs, movies and channels can then be made available only after an authorized password has been entered and accepted by the TV.

To select the options in the Parental sub-menu, press **OK**. Enter a password to access the Parental menu. The default password set in the factory is **0 0 0 0**.

Note: The Parental menu does not appear when the input mode is set to HDMI.

A new menu will be displayed showing the following Parental settings:

Rating Enable

Select from ON or OFF. If set to OFF, you will not be able to set the US TV, US Movie, Canadian English, or Canadian French Ratings.

Channel Block

Block individual channels from being displayed.

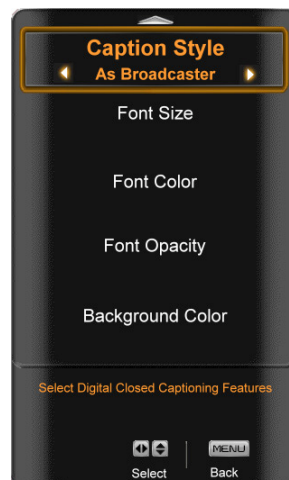
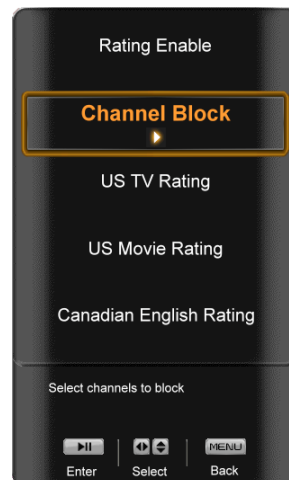

US TV Rating

Note: When Rating Enable is OFF, US TV Rating adjustments are not available.

Press the OK button to block (locked) or allow (unlocked) channels by the following US TV ratings:

- Y – All children
- Y7 – Older children
- G – General audience
- PG – Guidance suggested
- 14 – Strongly cautioned
- MA – Mature audience

You can also customize the TV ratings for the following content:

- A – All sub-ratings
- D – Sexual dialog
- L – Adult language
- S – Sexual situations
- V - Violence
- FV – Fantasy violence

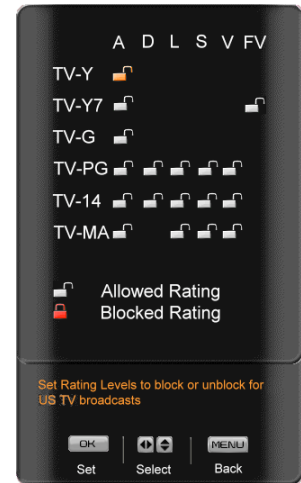

US Movie Rating

Note: When Rating Enable is OFF, US Movie Rating adjustments are not available.

Press the **OK** button to block (locked) or allow (unlocked) channels by the following US Movie ratings:

- G – General audience
- PG – Parental guidance suggested
- PG-13 – Recommended for children 13 years of age or older
- R – Mature audience
- NC-17 – No one under 17 years of age
- X – No one under 17 years of age

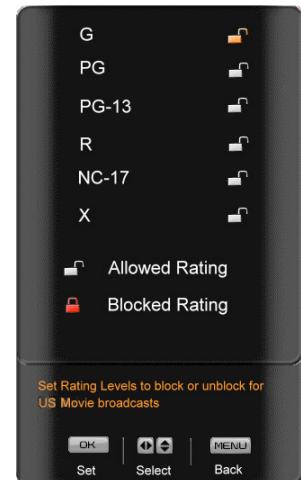

Canadian English Rating

Note: When Rating Enable is OFF, Canadian English Rating adjustments are not available.

Press the **OK** button to block (locked) or allow (unlocked) channels by the following Canadian English ratings:

- C – Children
- C8+ – Children 8 years or older
- G – General Programming, suitable for all audiences
- PG – Parental guidance
- 14+ – Viewers 14 years or older
- 18+ – Adult programming



Canadian French Rating

Note: When Rating Enable is OFF, Canadian French Rating adjustments are not available.

Press the **OK** button to block (locked) or allow (unlocked) channels by the following Canadian French ratings:

- G – General audience
- 8 ans+ – General – not recommended for young children
- 13 ans+ – Not suitable for children under 13 years of age
- 16 ans+ – Not suitable for under 16 years of age
- 18 ans+ – Adults only

DTV Rating

This option updates the TV or Movie rating table for digital programs in your local or regional area. It will allow the parental guidance control feature in your TV to have the most current parental control database for a digital signal. If *Not Available* appears at the bottom of the menu, then no update is available (the option is not activated in your area). This option may be available in the future for activation.

Block Unrated TV

Block programming that does not have a rating.

Change the Password

Select Access Code Edit to enter a new, 4-digit password using the number buttons on the remote control. Enter it a second time to confirm you entered it correctly.

Note: Make sure you write down and store the new password in a secure place. The System Reset feature (following) does NOT reset the password.



System Info

Display the technical information including model name, version and revision of firmware, source type, and resolution.

System Reset

To select the options in the System Reset sub-menu, press the **OK** button or the **▶** button. A new menu will be displayed showing the following System Reset settings:

Setup Wizard

Use this function to return to the Initial Setup menu. Use this function if you want to have a guided setup when you move your TV. Please refer to Chapter 3 for more information.

Note: Previously scanned channels will be removed.

Reset All Settings

Use this function to reset the TV to the default factory settings.

The screen will display a message to confirm that you want to reset the values to factory settings.

Note: This does **NOT** reset the Parental Control Password.



Understanding Viewing Features

Your HDTV features the following viewing modes. You can switch viewing modes using the remote control, please follow the instructions on page 14.

Viewing Modes

Normal Mode

The original 4:3 aspect ratio (1.33:1 source) is preserved, so black bars are added to the left and right of the display image. Standard TV broadcasts are displayed with a 4:3 Aspect Ratio. Movies in 4:3 Aspect Ratio may be referred to as pan-and-scan or full frame. These movies were originally filmed in 16:9 (widescreen), and then modified to fit a traditional TV screen (4:3).

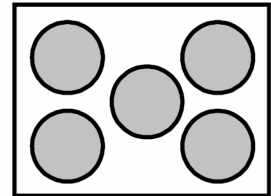

Full

Full mode allows you to view the entire picture. Recommended for HDMI and RGB / Computer viewing so you can see the complete picture without the image overstretching beyond the viewing area. If you experience “noise” along the border switch to Zoom 1. For 720p, 1080i, 1080p only.

Zoom 1

When watching a standard broadcast or full-frame movie in this mode, the display image is stretched proportionately to fill the TV screen. When watching a widescreen (1.78:1 source) program or movie, the display image fills the TV screen. If you are watching a widescreen (1.85:1 or 2.35:1 source) program or movie, there will still be black bars at the top and bottom.

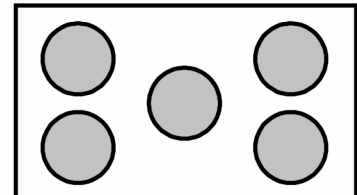

Zoom 2

Zooms in by 14% to crop the top and bottom bars for 2.35:1 film resolutions. For 480i/p, 4:3 only.

Stretch Mode

When watching a widescreen program (1.78:1 source) with black bars on the sides, the display image will stretch to fill the TV screen. People will appear wider than they really are. If you are watching a widescreen (1.85:1 or 2.35:1 source) program or movie, there will still be black bars at the top and bottom. This mode is available only when watching a widescreen program.

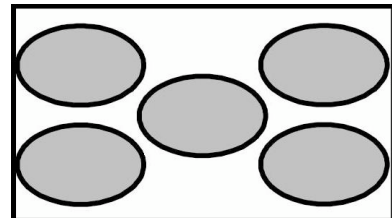

Panoramic Mode

When watching a standard broadcast or full frame movie in this mode, the 4:3 Aspect Ratio (1.33:1 source) display image is stretched horizontally on the left and right sides to fill the TV screen. The center of the image is not stretched.

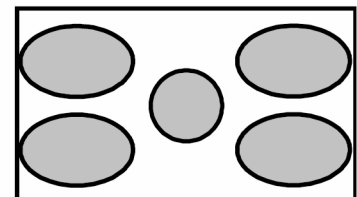

Note: When in PIP/POP the screen is fixed in Zoom1 mode.



Chapter 6

Programming the VIZIO Universal Remote Control

You can program the remote control to work with up to four different pieces of equipment including your VIZIO HDTV. Listed below are the steps for programming your VCR, Cable Box and DVD Player.

Programming for VCR

1. Manually turn on the VCR.
2. Press the VCR button on the remote control.
3. Press and hold the SET button until the LED LIGHT flashes twice.
4. Find the programming code for your VCR in the code list in the back of this book and enter it using the Number Buttons. If the code is accepted, the LED flashes twice after the last digit is entered.
If the LED does not flash twice, repeat Steps 2 through 4 with the next code listed for the component and manufacturer.
5. Point the remote control at the VCR and press the POWER button. The VCR will turn off.

Note:

- If your VCR does not respond, try all the codes for your VCR brand. If the codes do not work, or your brand is not listed, see “Searching for Component Codes.”
- Sometimes a code listed will only include limited functions. Try other codes that may include more functionality.

Programming for Cable Set-Top Box

1. Manually turn on the Cable Box.
2. Press the CBL button on the remote control.
3. Press and hold the SET button until the LED LIGHT flashes twice.
4. Find the programming code for your Cable Box in the code list in the back of this book and enter it using the Number Buttons. If the code is accepted, the LED flashes twice after the last digit is entered.
If the LED does not flash twice, repeat Steps 2 through 4 with the next code listed for the component and manufacturer.
5. Point the remote control at the Cable Box and press the POWER button. The Cable Box will turn off.
If the LED does not flash twice, repeat Steps 2 through 4 with the next code listed for the component and manufacturer.

Note:

- If your Cable Set-Top Box does not respond, try all the codes for your brand. If the codes do not work, or your brand is not listed, see “Searching for Component Codes.”
- Sometimes a code listed will only include limited functions. Try other codes that may include more functionality.



Programming for DVD Player

1. Manually turn on the DVD Player.
2. Press the DVD button on the remote control.
3. Press and hold the SET button until the LED LIGHT flashes twice.
4. Find the programming code for your DVD player in the code list in the back of this book and enter it using the Number Buttons. If the code is accepted, the LED flashes twice after the last digit is entered.
If the LED does not flash twice, repeat Steps 2 through 4 with the next code listed for the component and manufacturer.
5. Point the remote control at the DVD Player and press the POWER button. The DVD Player will turn off.

Note:

- If your DVD player does not respond, try all the codes for your brand. If the codes do not work, or your brand is not listed, see “Searching for Component Codes.”
- Sometimes a code listed will only include limited functions. Try other codes that may include more functionality.

Searching for Component Codes

If you cannot find the manufacturer in the component list or the program code does not work, you can use the remote control to search for the correct component code.

To search for a component code:

1. Turn on the component.
2. Press the matching component button on the remote control.
3. Press and hold the SET button until the LED flashes twice.
4. Press 9 9 1. The LED flashes twice.
5. Point the remote control at the component and then alternate between pressing the POWER button and the component button on the remote control until the component turns off. If the component still does not respond, clear the component button, then repeat the search procedure.

Using a Cable or Satellite Remote

Your VIZIO remote uses codes 000, 047, 050, 067, 329, 331 and 339 to work your LCD HDTV. To use a cable or satellite remote to work the LCD HDTV, refer to your cable or satellite remote user guide for more information on how to program the remote. If your cable or satellite remote uses a 5-digit code (like most Direct TV units), first try 11758 and then, if that does not work, 10178. If your cable or satellite remote uses a 4-digit code, try 1758 and then 0178 as an alternative. If your cable or satellite remote uses a 3-digit code (EchoStar or Dish Network for example), use code 627.

Note: Some buttons may not function as expected on your cable or satellite remote. Typically power, volume and mute will work.



Chapter 7 Maintenance and Troubleshooting

Maintenance

Important

1. Make sure that the power cable is removed from the socket before cleaning the TV.
2. Do not use volatile solvent (such as toluene, rosin and alcohol) to clean the TV. Such chemicals may damage the housing, screen glass and remote control, and cause paint to peel.

Cleaning the Housing and Remote Control

1. Use a soft cloth for cleaning.
2. If the housing or remote control is seriously contaminated, use a soft cloth moistened with diluted neutral cleaner to clean the display. Wring water out of the cloth before cleaning to prevent water from penetrating into the housing. Wipe the display with a dry cloth after cleaning.

Cleaning the Screen

1. Use a soft cloth to gently clean the screen.
2. The screen glass is very fragile. Do not scrape it with any sharp object. Do not press or tap the screen to avoid cracking. When the screen is seriously contaminated, use a soft cloth moistened with diluted neutral cleaner to clean the display. Wring water out of the cloth before cleaning to prevent water from penetrating into the housing. Wipe the display with a dry cloth after cleaning.



Troubleshooting Guide

If the TV fails or the performance changes dramatically, check the display in accordance with the following instructions. Remember to check the peripherals to pinpoint the source of the failure. If the display still fails to perform as expected, contact the VIZIO for assistance by calling 1-877-MYVIZIO (698-4946) or e-mail us at techsupport@vizio.com.

General TV Problems	Solution
Receive the error message "No Signal."	<ul style="list-style-type: none"> Press the INPUT button on the remote control to select a different input source. If you are using cable connected directly to the TV or an antenna, scan for channels from the Tuner menu in the OSD.
No power.	<ul style="list-style-type: none"> Make sure the power button is ON (VIZIO logo glows white). Make sure AC power cord is securely connected to the AC socket. Plug another electrical device to the power outlet to verify that the outlet is working.
No sound.	<ul style="list-style-type: none"> Press Volume + (Up) on the remote control. Press MUTE on the remote control to make sure that MUTE is not ON. Check your audio settings. The audio may be set to SAP, or the speakers are set to off. Make sure that headphones are not connected. Check the audio connections of external devices that may be connected to the HDTV. If you are using an antenna, the signal strength of the channel may be low. Make sure your antenna is connected securely to the TV and move the antenna around the room or close to a window.
If the screen is black.	<ul style="list-style-type: none"> Make sure the power button is ON (VIZIO Logo glows white). Press the INPUT button on the remote control to select a different input source. Check the connections of external devices that may be connected to the HDTV.
Power is ON but there is no image on the screen.	<ul style="list-style-type: none"> Make sure all cables attached to the HDTV are connected to the correct output on the external device. Adjust brightness, contrast or backlight. Press the INPUT button on the remote control to select a different input source.
Wrong or abnormal colors appear.	<ul style="list-style-type: none"> Check Color and Tint settings in Picture Menu. Reset Picture settings. Check the video cables to make sure they are securely connected. If you are using an antenna, the signal strength of the channel may be low. Make sure your antenna is connected securely to the TV and move the antenna around the room or close to a window.
Control buttons do not work.	<ul style="list-style-type: none"> Press only one button at a time.
Remote control does not work.	<ul style="list-style-type: none"> Point the remote control directly at the remote sensor on your TV. Remove any obstacles between the remote control and the remote sensor. Replace dead batteries with new ones. Make sure you have selected TV mode on the remote control.
There appear to be image quality issues.	<ul style="list-style-type: none"> If you are using an antenna, the signal strength of the channel may be low. Make sure your antenna is connected securely to the TV and move the antenna around the room or close to a window. For best image quality, view HD wide-screen programs where possible. If HD content is not available view "Standard Definition" from a digital source.



General TV Problems	Solution
	<ul style="list-style-type: none"> Standard, analog TV will always be noticeably inferior to HD because your digital flat panel TV has video that is many times better than old TV so you will see interference and deficiencies you did not know you had.
<p>You cannot see a picture.</p>	<ul style="list-style-type: none"> Make sure the power button is ON (VIZIO logo glows white). Make sure AC power cord is securely connected to the AC socket. Press the INPUT button on the remote control to select a different input source. Check the connections of external devices that may be connected to the HDTV. If your HDTV is connected to a computer, press any button on your keyboard to “wake” your computer. If you are using an antenna, the signal strength of the channel may be low. Make sure your antenna is connected securely to the TV and move the antenna around the room or close to a window.
<p>You see a distorted picture or hear unusual sound.</p>	<ul style="list-style-type: none"> You may be getting interference from electrical appliances, cars, motorcycles, or fluorescent lights. If you have not mounted it on the wall, try moving your HDTV to another location to see if this is the cause of the problem.
<p>The picture has abnormal patterns.</p>	<ul style="list-style-type: none"> Check the connections of external devices that may be connected to the HDTV. Make sure the specifications of external devices meet the specifications of your HDTV (i.e. resolution). If you are using an antenna, the signal strength of the channel may be low. Make sure your antenna is connected securely to the TV and move the antenna around the room or close to a window.
<p>The display image does not cover the entire screen.</p>	<ul style="list-style-type: none"> If you are in RGB mode (Computer), make sure that H-Size and V-Position in the On Screen Display (OSD) are set correctly. If you are using TV, AV, or Component with 480i input, press WIDE button on the remote control to scroll through various screen modes.
<p>You can see a picture but you cannot hear sound.</p>	<ul style="list-style-type: none"> Press Volume + (Up) on the remote control. Press MUTE on the remote control to make sure that MUTE is not ON. Check your audio settings. The audio may be set to SAP, or the speakers are set to off. Make sure that headphones are not connected. Check the audio connections of external devices that may be connected to the HDTV.
<p>The TV has pixels (dots) that are always dark or colored.</p>	<ul style="list-style-type: none"> Your HDTV is manufactured using an extremely high level of precision technology, however, sometimes some pixels of your HDTV may not display. Pixel defects within industry specifications are inherent to this type of product and do not constitute a defective product.
<p>You see “noise” or “trash” on the screen.</p>	<ul style="list-style-type: none"> When your HDTV’s digital capabilities exceed a digital broadcast signal, the signal is up-converted (increased) to match your TV’s display capabilities. Up-converting can cause noise or trash. If you are using an antenna, the signal strength of the channel may be low. Make sure your antenna is connected securely to the TV and move the antenna around the room or close to a window.
<p>You switch to a different input and the volume changes.</p>	<ul style="list-style-type: none"> The TV remembers the volume level from the last time you adjusted it. If the sound level is higher or lower from another source, then the volume will change.
<p>You switch to a different input and the screen size changes.</p>	<ul style="list-style-type: none"> The TV remembers the viewing mode from the last time you used a particular input (AV-1, AV-2, Component, HDMI and TV).
<p>Tips for High-Definition Users.</p>	<ul style="list-style-type: none"> Your HDTV is an ideal platform for viewing High Definition Content. Best image quality will be achieved by HDMI. The next best is Component,



General TV Problems	Solution
	followed by Composite. <ul style="list-style-type: none"> • Due to variances in broadcast practices, it is possible some image distortions can occur.
Tips for Letterbox Content Users.	<ul style="list-style-type: none"> • Some Letterboxed (or “Widescreen”) versions of DVD movies are formatted for standard 4:3 Televisions. Your HDTV has the ability to expand this content so the entire screen is filled at the expense of image accuracy. To use this function, press ZOOM on the remote control to cycle among the options.

Media Viewer Problems	Solution
USB device is not recognized.	<ul style="list-style-type: none"> • Make sure the device is correctly inserted. • Make sure the device is FAT or FAT32 • Make sure it contains the supported files.
Image or sound is interrupted or distorted.	<ul style="list-style-type: none"> • Make sure the device is correctly inserted. • Make sure that the file complies with the supported format, bit rate and/or profile. Also check the file for damage. • Some files that comply with the supported format may not play back or display properly.
Slideshow doesn't start.	<ul style="list-style-type: none"> • Make sure the viewer isn't in pause, rotation, or zoom mode.

Telephone & Technical Support

Products are often returned due to a technical problem rather than a defective product that may result in unnecessary shipping charges billed to you. Our trained support personnel can often resolve the problem over the phone. For more information on warranty service or repair, after the warranty period, please contact our Support Department at the number below.

Customer support and quality service are integral parts of VIZIO's commitment to service excellence. For technical assistance contact our VIZIO Technical Support Department via email or phone.

Email: techsupport@vizio.com

(877) 698-4946 Fax: (949) 585-9563

Hours of operation: Monday - Friday: 6 am to 9 pm

Saturday – Sunday: 8 am to 4 pm

Please have your VIZIO model number, serial number, and date of purchase available before you call.

VIZIO

Address:

39 Tesla

Irvine, CA 92618, USA

Telephone: (949) 428-2525 Fax: 949-585-9514

Web: www.vizio.com



Compliance

Caution: Always use a power cable that is properly grounded. Please use the AC cords listed below for each area.

USA	UL
Canada	CSA
Germany	VDE
UK	BASE/BS
Japan	Electric Appliance Control Act

FCC Class B Radio Interference Statement

NOTE: This equipment has been tested and found to comply with the limits for a Class B digital device, pursuant to Part 15 of the FCC Rules. These limits are designed to provide reasonable protection against harmful interference in a residential installation. This equipment generates, uses and can radiate radio frequency energy, and if not installed and used in accordance with the instructions, may cause harmful interference to radio communications. However, there is no guarantee that interference will not occur in a particular installation. If this equipment does cause harmful interference to radio or television reception, which can be determined by turning the equipment off and on, the user is encouraged to try to correct the interference by one or more of the following measures:

1. Reorient or relocate the receiving antenna.
2. Increase the separation between the equipment and receiver.
3. Connect the equipment into an outlet on a circuit different from that to which the receiver is connected.
4. Consult the dealer or an experienced radio/TV technician for help.

Notice:

1. The changes or modifications not expressly approved by the party responsible for compliance could void the user's authority to operate the equipment.
2. Shielded interface cables and AC power cord, if any, must be used in order to comply with the emission limits.
3. The manufacturer is not responsible for any radio or TV interference caused by unauthorized modification to this equipment. It is the responsibilities of the user to correct such interference.



Chapter 8 Specifications

Specifications	
Panel	SV320XVT: 31.55" Diagonal, 16:9 Aspect Ratio SV370XVT: 37" Diagonal, 16:9 Aspect Ratio
Resolution	1920 x 1080 pixels
Pixel (Dot) Pitch	SV320XVT: 0.36375mm(H) x 0.36375mm(V) SV370XVT: 0.42675mm(H) x 0.42675mm(V)
Display Compatibility	HDTV (1080P)
Colors	1.06 Billion
Brightness cd/m ² (typical)	500nits
Contrast	SV320XVT: 1200:1; DCR: 50,000:1 SV370XVT: 1300:1; DCR: 50,000:1
Response Time	SV320XVT: 6ms (typical) SV370XVT: 5ms (typical)
Viewing Angle	178° (horizontal/vertical)
Inputs	1x RF 1x Composite Video and stereo audio (one stereo audio shared with Component input) 1x S-Video 1x Component and stereo audio (one stereo audio shared with Composite input) 3x HDMI 1x RGB 1x Media Port (USB)
Outputs	1x SPDIF Optical Digital Audio, 1x Stereo Audio
Features	1080P HDTV, MEMC, 120Hz Panel, HDMI v1.3, 3D Comb Filter, Digital Audio Amplifier, Dolby Digital for ATSC/QAM, Signal Compatibility: 480I(SDTV), 480P(EDTV), 720P(HDTV), 1080I(HDTV), 1080P(HDTV), Channel Skip/Add, VIDEO/INPUT Naming Capability, Closed Caption, Parental Control/V-CHIP 2.0, Programmable Timer, Freeze, PIP/POP, SRS TSHD, SRS TruVolume, Zero Bright Pixel Guarantee, Dynamic Contrast Ratio Technology, HD Game Port, Game Mode, Noise Reduction, 10-bit(D) panel, 10-bit video processing, MTS Stereo Decoder, Dolby Digital for ATSC/QAM, VESA Mount Compatible. ATSC/Clear QAM tuner, NTSC video decoding, 3:2 or 2:2 reverse pull-down, Motion adaptive de-interlace, Progressive video scan via Component/VGA/HDMI, HDTV via HDMI or Component, Color temperature adjustments of 6500K/9300K/11000K, Independent Red/Green/Blue adjustments for color temperature fine tuning, Computer support at 640x480/800x600/1360x768/1920x1080 via VGA/HDMI.
Special Features	<ul style="list-style-type: none"> • Detachable Base • Mega DCR • MEMC, 120Hz Panel • SRS TruVolume, SRS TSHD • Optimal power control to reduce average power consumption
Speakers	2xBuilt-in, 10W Speakers
Panel Life	50,000 hours to half the original brightness



Power	
Input	IEC Connector for direct power line connection
Voltage Range	100~240Vac at 50/60Hz
Power Consumption	SV320XVT: 98W (Avg), <0.5W standby SV370XVT: 125W (AVG) , <0.5W standby
Environmental Conditions	
Operating	Temperature: 5°C~35°C, Relative Humidity: 20~80%, Altitude: 0~14,000 ft
Non-Operating	Temperature: -20°C~50°C, Relative Humidity: 10~70%, Altitude: 0~40,000 ft
Dimensions	SV320XVT: 30.6"W x 22.4" H x 9.3" D with stand; 30.6" W x 22.1" H x 2.2" D without stand SV370XVT: 35.6"W x 24.8" H x 9.3" D with stand; 35.6" W x 23.1"H x 2.2" D without stand
Net Weight	SV320XVT: 23.2 lbs without stand, 25.4 lbs with stand SV370XVT: 28.7 lbs without stand, 30.5 lbs with stand
Gross Weight	SV320XVT: 30.86 lbs SV370XVT: 37.04 lbs
Certifications	CSA, CSA-US, FCC Class B
Compliances	Energy Star 3.0. ATSC Spec A/65, EIA/CEA-766-A

*Product specifications may change without notice or obligation.

Note: The Federal Communications Commission (FCC), the Consumer Electronics Association (CEA) and the Consumer Electronics Retailers Coalition (CERC) have made a new tip sheet available for digital television (DTV) retailers to reproduce and distribute to consumers on the sales floor. The file may be downloaded online at www.dtv.gov. While you're there, check out the other useful information in the FCC is making available to consumers interested in learning more about the analog to digital transition.



Remote Control Codes

TV Codes (including TV/DVD, TV/VCR, TV/DVD/VCR)	
3M	10195
888	10462
A.R. Systems	10352
Abex	10065, 10256
ACE	10449
Acer	10164
Addison	10048, 10231
Admiral	10045, 10078, 10232, 10236
Advent	10221, 10291
Adventura	10066, 10261
Aiko	10053, 10231
Aim	10353
Aiwa	10178, 10207
Akai	10027, 10046, 10127, 10153, 10196, 10229, 10238, 10240, 10254, 10267, 10304, 10353
Akiba	10353
Akito	10348, 10353
Akura	10277, 10353
Alaron	10246, 10273, 10275
Alba	10353
Albatron	10219, 10222, 10286
Alfide	10240
Alleron	10055
Allstar	10353
A-Mark	10248
America Action	10234
Ampro	10220, 10289
Amstrad	10279, 10353
Amtron	10054
Anam	10234
Anam National	10054, 10264
Anhua	10455
Anitech	10353
AOC	10047, 10048, 10049, 10112,

TV Codes (including TV/DVD, TV/VCR, TV/DVD/VCR)	
	10229, 10248, 10252, 10254, 10263, 10274, 10316
Aolinpiya	10462
Aolinpu	10465
Apex	10075, 10095, 10233
Apex Digital	10288
Archer	10248
Archos	10156
Ardem	10353
Aristona	10353
Asberg	10353
Astar	10163
Atlantic	10353
Audinac	10234, 10278
Audiosonic	10352, 10353
Audiovox	10054, 10099, 10231, 10234, 10248, 10280, 10287, 10326
Aventura	10042
Awa	10048, 10351
Axon	10154, 10326
Baihehua	10461
Baihua	10460, 10462
Baile	10458, 10460
Bang & Olufsen	10244
BaoHuaShi	10462
Baosheng	10457, 10460
Barco	10282
Basic Line	10352, 10353
Baur	10249, 10281, 10353
Baysonic	10234
Beijing	10358, 10360, 10362, 10364, 10365, 10366, 10367, 10368, 10369, 10370, 10371, 10372, 10373, 10374, 10376, 10377, 10378, 10379,

TV Codes (including TV/DVD, TV/VCR, TV/DVD/VCR)	
	10380, 10383, 10384, 10385, 10392, 10394, 10428, 10431, 10448, 10457, 10458, 10460, 10461, 10462
Belcor	10047, 10252
Bell & Howell	10045
Benq	10116, 10159, 10226, 10300
Beon	10353
Bestar	10352, 10353
Bestar-Daewoo	10352
Blaupunkt	10281
Blue Sky	10282, 10353
Boots	10348
Boxlight	10290
BPL	10275, 10353
Bradford	10054, 10234
Brilliant	10160
Brinkmann	10353
Brockwood	10047, 10252
Broksonic	10078, 10234, 10236, 10248
Bush	10348, 10352, 10353
byd:sign	10214
Caihong	10360, 10362, 10368, 10457, 10460
Cailing	10464
Caixing	10366, 10367, 10378, 10380, 10390, 10461
Candle	10047, 10049, 10050, 10066, 10229, 10254, 10261, 10265
Carena	10353
Carnivale	10229, 10254
Carver	10034, 10044, 10271
Cascade	10353
Casio	10353



TV Codes (including TV/DVD, TV/VCR, TV/DVD/VCR)	
Cathay	10353
Caton	10355
CCE	10246, 10258, 10353
Celebrity	10046
Celera	10075
Centurion	10051, 10353
Changcheng	10357, 10360, 10362, 10363, 10364, 10366, 10367, 10368, 10369, 10370, 10371, 10372, 10373, 10374, 10376, 10378, 10379, 10380, 10384, 10385, 10392, 10448, 10455, 10457, 10458, 10460, 10461, 10462
Changfei	10360, 10362, 10368, 10379, 10457, 10460, 10467
Changfeng	10360, 10367, 10376, 10381, 10382, 10384, 10385, 10392, 10457, 10462
Changhai	10360, 10362, 10368, 10457, 10460, 10467
Changhong	, 10075, 10356, 10358, 10359, 10360, 10361, 10362, 10369, 10371, 10376, 10383, 10386, 10387, 10388, 10389, 10393, 10394, 10412, 10427, 10433, 10436, 10448, 10457, 10460
Chaparral	10442
Chengdu	10360, 10368, 10457
Chimei	10217
Ching Tai	10231
Chun Yun	10222, 10231, 10234, 10329, 10342
Chunfeng	10362, 10368, 10376, 10384,

TV Codes (including TV/DVD, TV/VCR, TV/DVD/VCR)	
	10385, 10392, 10405, 10460, 10462
Chung Hsin	10048, 10234, 10332
Chunlan	10397, 10468
Chunsun	10360, 10362, 10368, 10457, 10460
Cinego	10327
Cineral	10231, 10280
Citizen	10047, 10049, 10050, 10053, 10054, 10062, 10064, 10229, 10231, 10238, 10254, 10259, 10261, 10265, 10325, 10347
Clairtone	10274
Clarion	10234
Clarivox	10353
Clatronic	10353
Coby	10108
Colortyme	10047, 10049
Colt	10344
Commercial Solutions	10230
Concerto	10047, 10049, 10265
Condor	10353
Conrowa	10422, 10460, 10462
Contec	10234, 10268, 10269, 10274, 10353
Contec/Cony	10052, 10054
Cosmel	10353
Craig	10054, 10234
Crosley	10034, 10044, 10076
Crown	10054, 10058, 10234, 10240, 10259, 10353
Crown Mustang	10240
CTX	10115
Curtis Mathes	10016, 10027, 10034, 10044, 10047, 10049,

TV Codes (including TV/DVD, TV/VCR, TV/DVD/VCR)	
	10062, 10064, 10229, 10230, 10232, 10238, 10239, 10254, 10259, 10265, 10280
CXC	10054, 10234
CyberHome	10294
Cytron	10152, 10310
Daewoo	10047, 10048, 10049, 10053, 10064, 10076, 10231, 10240, 10252, 10259, 10280, 10325, 10347, 10352, 10353
Dansai	10353
Dawa	10353
Daytron	10047, 10049, 10064, 10252, 10352, 10353
Dayu	10458
De Graaf	10275
Decca	10348, 10353
Dell	10019, 10124
Denon	10239
Denstar	10284
Denver	10353
Desmet	10353
Diamant	10353
Diamond Vision	10216, 10328
Digatron	10353
Dimensia	10016
Disney	10093
Dixi	10353
DongBao	10448
DongDa	10362, 10368, 10448, 10460
Donghai	10362, 10368, 10460
DongHua	10448
Donglin	10391
Dual	10353
Dumont	10020, 10047, 10228, 10252, 10266



TV Codes (including TV/DVD, TV/VCR, TV/DVD/VCR)	
Durabrand	10042, 10078, 10227, 10234, 10236, 10248, 10272
Dux	10353
D-Vision	10353
Dwin	10232, 10293
Dynatech	10262
Dynatron	10353
Dynex	10143, 10189
Ectec	10278
Eiki	10169, 10170
Electroband	10046, 10274
Electrograph	10206, 10321
Electrohome	10046, 10047, 10049, 10078
Elektra	10228
Element	10136
ELG	10353
Elin	10353
Emerson	10042, 10047, 10049, 10052, 10054, 10055, 10064, 10076, 10078, 10135, 10234, 10236, 10252, 10259, 10269, 10272, 10273, 10274, 10325, 10347, 10353
Emprex	10215
Envision	10047, 10049, 10112, 10229, 10254, 10316
Epson	10113, 10302
Erres	10250, 10353
ESA	10042, 10127
ESC	10353
Ether	10330
Euroman	10353
Europa	10353
Exquisit	10353
Feilang	10362, 10368, 10460
Feilu	10360, 10362, 10368, 10457,

TV Codes (including TV/DVD, TV/VCR, TV/DVD/VCR)	
	10460
Feiyan	10376, 10384, 10385, 10392, 10462
Feiyue	10360, 10362, 10366, 10367, 10368, 10378, 10380, 10457, 10460, 10461
Fenmenti	10353
Fenner	10352
Ferguson	10048
Fidelity	10353
Filmnet	10440
Finlandia	10275
Finlux	10266
Firstline	10352, 10353
Firstar	10340
Fisher	10270, 10275
FlexVision	10287
Flint	10353
Fraba	10353
Friac	10353
Frontech	10277
Fujitsu	10050, 10055, 10208, 10273
Funai	10042, 10054, 10055, 10234, 10273, 10324
Furi	10336
Futuretech	10054, 10234, 10277
Galaxis	10353
Ganxin	10457, 10461
Gateway	10119, 10206, 10241, 10322
GBC	10352
GE	10016, 10047, 10049, 10056, 10057, 10070, 10088, 10230, 10253, 10264, 10272, 10280, 10345
GEC	10353
Geloso	10352
Genexxa	10353

TV Codes (including TV/DVD, TV/VCR, TV/DVD/VCR)	
GFM	10040, 10140
Gibraltar	10020, 10047, 10228, 10229, 10252, 10254
GoldStar	10047, 10048, 10049, 10052, 10064, 10065, 10229, 10252, 10254, 10256, 10272, 10346, 10353
Goodmans	10352, 10353
Gradiente	10036, 10118, 10265, 10271
Granada	10048, 10275, 10353
Grandin	10352, 10353
Great Wall	10349
Grundig	10240, 10258, 10266, 10281, 10353
Grunpy	10054, 10055, 10234, 10273
Haier	10139, 10148, 10174, 10209, 10227, 10247, 10354, 10380, 10395, 10396, 10399, 10403, 10404, 10414, 10416, 10417, 10418, 10419, 10421, 10423, 10424, 10466
HaiHong	10362, 10368, 10369, 10370, 10371, 10372, 10373, 10391, 10395, 10448, 10460
Haile	10375
Haiyan	10360, 10366, 10367, 10376, 10378, 10380, 10384, 10385, 10392, 10457, 10461, 10462
Hallmark	10047, 10049, 10272
Hankook	10234, 10330, 10339
Hannspree	10315
Hanseatic	10353
Hantarex	10313, 10353



TV Codes (including TV/DVD, TV/VCR, TV/DVD/VCR)	
Hantor	10353
Harley Davidson	10260, 10273, 10324
Harman/Kardon	10034, 10044
Harvard	10054, 10234
Harwood	10353
Hauppauge	10353
Havermy	10232
HCM	10279, 10353
Helios	10145
Hello Kitty	10210, 10280
Hewlett Packard	10101, 10301
Highline	10353
Himitsu	10234, 10284
Hinari	10353
Hisense	10121, 10288, 10338, 10350, 10356, 10358, 10361, 10368, 10381, 10382, 10386, 10395, 10396, 10397, 10400, 10401, 10407, 10408, 10416, 10417, 10418, 10419, 10426, 10428, 10431, 10459
Hitachi	10047, 10048, 10049, 10052, 10131, 10184, 10239, 10256, 10265, 10324, 10353
Hitachi Fujian	10048, 10457, 10459, 10461, 10462
Hornyphone	10353
Hongmei	10359, 10360, 10362, 10366, 10367, 10368, 10376, 10378, 10380, 10385, 10386, 10387, 10392, 10457, 10460, 10461, 10462
Hongyan	10457, 10462
Hotel TV	10447
HP	10301
Huafa	10460

TV Codes (including TV/DVD, TV/VCR, TV/DVD/VCR)	
Huanghaimei	10362, 10368, 10460
Huanghe	10360, 10362, 10366, 10367, 10368, 10378, 10380, 10383, 10395, 10406, 10457, 10460, 10461
Huanglong	10362, 10368, 10460
Huangshan	10360, 10362, 10366, 10367, 10368, 10375, 10376, 10378, 10380, 10384, 10385, 10392, 10457, 10460, 10461, 10462
Huanyu	10352, 10359, 10360, 10366, 10367, 10376, 10378, 10380, 10384, 10385, 10386, 10387, 10392, 10457, 10459, 10461, 10462
Huaqiang	10376, 10384, 10385, 10392, 10462
Huari	10462
Humax	10197
Huodateji	10455
Hypson	10277, 10353
Hyundai	10171, 10224
Iberia	10353
ICE	10277
Ilo	10149, 10151, 10307, 10320
IMA	10054
Imperial	10353
Imperial Crown	10458, 10462
Indiana	10353
Infinity	10034, 10044, 10058
InFocus	10125, 10290
Initial	10151, 10320
Innova	10258
Insignia	10141, 10142, 10143, 10181,

TV Codes (including TV/DVD, TV/VCR, TV/DVD/VCR)	
	10310
Inteq	10228
Interbuy	10353
Interfunk	10353
Internal	10353
Intervision	10277, 10353
IR	10351, 10352, 10353
Irradio	10353
IRT	10280, 10284
Isukai	10353
ITS	10353
ITV	10352, 10353
Janeil	10066, 10261
JBL	10034, 10044, 10058
JC Penney	10016, 10047, 10048, 10049, 10050, 10056, 10057, 10062, 10064, 10065
JCB	10046
Jean	10231, 10331, 10338, 10340
Jensen	10047, 10049, 10291
Jiahua	10357, 10363, 10375, 10376, 10411, 10455
JiaLiCai	10414, 10448, 10460, 10462
Jinfeng	10357, 10360, 10365, 10455, 10457
Jinhai	10359, 10386, 10387
Jinlipu	10386
Jinque	10457, 10460, 10462
Jinta	10460, 10461, 10462
Jinxing	10333, 10336, 10338, 10358, 10360, 10367, 10368, 10375, 10376, 10377, 10383, 10386, 10389, 10390, 10392, 10394, 10397, 10408,



TV Codes (including TV/DVD, TV/VCR, TV/DVD/VCR)	
	10426, 10457, 10462
Juhua	10457, 10461, 10462
JVC	10036, 10037, 10038, 10052, 10057, 10059, 10078, 10257
Kaige	10457, 10460, 10461, 10462
Kaisui	10353
Kamp	10246
Kangchong	10359, 10386, 10387
Kanghua	10395
Kangli	10422, 10448, 10457, 10458, 10460, 10461, 10462
Kangyi	10390, 10460, 10462
Kawasho	10046, 10047, 10049, 10246, 10269
Kaypani	10263
KDS	10295
KEC	10234
Kendo	10353
Kenwood	10047, 10049, 10229, 10252, 10254
Kioto	10034, 10282
Kiton	10353
KLH	10075
Kloss	10261
Kloss Novabeam	10054, 10066
Kneissel	10352, 10353
Kolin	10048, 10234, 10337
Kongque	10457, 10460, 10461, 10462
Konka	10211, 10237, 10284, 10353, 10355, 10360, 10363, 10372, 10375, 10388, 10389, 10391, 10392, 10397, 10402, 10430
Korpel	10353

TV Codes (including TV/DVD, TV/VCR, TV/DVD/VCR)	
Kost	10306
Kreisen	10298
KTV	10054, 10064, 10229, 10234, 10246, 10254, 10259, 10274
Kuaile	10460, 10462
Kunlun	10357, 10360, 10365, 10368, 10376, 10377, 10378, 10379, 10455, 10457, 10458, 10462
Lecson	10353
Lenco	10352, 10353
Leyco	10277, 10353
LG	10019, 10048, 10100, 10129, 10167, 10175, 10185, 10198, 10199, 10200, 10219, 10225, 10245, 10254, 10265, 10272, 10286, 10323, 10353
Liesenk & Tter	10353
Lifetec	10352, 10353
Lihua	10457
Lloyd's	10324
Local India TV	10275
Loewe	10058
Loewe Opta	10353
Logik	10045, 10351
Longjiang	10360, 10376, 10384, 10385, 10392, 10457, 10462
Lumatron	10353
Lux May	10353
Luxman	10047, 10049, 10265
LXI	10016, 10034, 10044, 10049, 10058, 10230, 10233, 10272
M & S	10034
Melectronic	10352, 10353
Madison	10353

TV Codes (including TV/DVD, TV/VCR, TV/DVD/VCR)	
MAG	10295
Magnasonic	10325, 10347
Magnavox	10034, 10044, 10047, 10049, 10050, 10058, 10073, 10086, 10089, 10134, 10229, 10254, 10257, 10273, 10316, 10324, 10351
Magnin	10345
Magnum	10353
Majestic	10045
Manesth	10277, 10353
Manhattan	10353
Marantz	10034, 10044, 10047, 10049, 10058, 10114, 10212, 10229, 10254, 10258, 10353
Mark	10352, 10353
Matsui	10275, 10348, 10351, 10353
Matsushita	10235, 10285
Maxent	10144, 10201, 10206, 10292
Mediator	10250, 10353
Medion	10353
Megapower	10219, 10286
Megatron	10049, 10239, 10248, 10272
MEI	10274
Meile	10457, 10461, 10462
MeiShi	10390
Memorex	10042, 10045, 10048, 10049, 10078, 10236, 10272, 10273, 10343, 10346
Mengmei	10461
Mercury	10353
Metz	10281, 10353
MGA	10047, 10048, 10049, 10229, 10252, 10254, 10272, 10345



TV Codes (including TV/DVD, TV/VCR, TV/DVD/VCR)	
Micromaxx	10353
Midland	10020, 10057, 10064, 10065, 10228, 10230, 10256, 10259
Minato	10353
Minerva	10048, 10266, 10281
Minoka	10279, 10353
Mintek	10151, 10320
Minutz	10056, 10253
Mitsubishi	10047, 10048, 10049, 10092, 10182, 10183, 10232, 10252, 10267, 10272, 10281, 10353
MoDeng	10390
Monivision	10219, 10222, 10286
Montgomery Ward	10045
Morgans	10353
Motorola	10232, 10264, 10295
Moxell	10295
MTC	10047, 10048, 10049, 10062, 10229, 10238, 10246, 10252, 10254, 10262, 10265, 10274
MTEC	10348
MuDan	10380, 10411, 10438, 10455, 10457, 10460, 10462
Multitec	10353
Multitech	10054, 10234, 10246, 10262, 10353
Multivision	10060
NAD	10049, 10233, 10258, 10265, 10272
Naiko	10353
Nakamichi	10318
Nanbao	10460, 10462
Nansheng	10360, 10376, 10384, 10385, 10392, 10457,

TV Codes (including TV/DVD, TV/VCR, TV/DVD/VCR)	
	10462
NEC	10047, 10048, 10049, 10162, 10212, 10218, 10229, 10252, 10254, 10257, 10265, 10271, 10351, 10352
Neckermann	10353
NEI	10353
Neovia	10313
Netsat	10258, 10353
Net-TV	10158, 10206, 10292
Neufunk	10353
New Tech	10353
Newave	10231, 10335, 10339
Nikkai	10277, 10353
Nikko	10049, 10053, 10229, 10231, 10254, 10272
Nisato	10278
Nokia	10352
Norcent	10112, 10288, 10301, 10316
Nordmende	10353
Normerel	10353
Norwood Micro	10307
Noshi	10251
Novatronic	10352, 10353
NTC	10053, 10231
Okano	10353
Olevia	10096, 10105, 10111, 10242, 10243, 10303, 10305, 10311
Olympus	10314
Onwa	10054, 10234
Opera	10353
Oppo	10155
Optimus	10235, 10285, 10343
Optoma	10126, 10194
Optonica	10061, 10232
Orbit	10353

TV Codes (including TV/DVD, TV/VCR, TV/DVD/VCR)	
Orion	10078, 10193, 10236, 10273, 10351, 10353
Orline	10353
Osaki	10277, 10279, 10348, 10352, 10353
Osio	10353
Osume	10353
Otto Versand	10249, 10281, 10353
Palladium	10353
Palsonic	10353
Panama	10277, 10353
Panasonic	10010, 10011, 10012, 10013, 10014, 10015, 10048, 10057, 10058, 10080, 10085, 10102, 10173, 10176, 10235, 10264, 10285, 10343
Panasonic/National	10353
Panavision	10353
Panda	10357, 10359, 10360, 10362, 10365, 10366, 10367, 10368, 10369, 10371, 10376, 10378, 10380, 10383, 10384, 10385, 10386, 10387, 10390, 10392, 10394, 10405, 10406, 10415, 10422, 10455, 10457, 10460, 10461, 10462
Penney	10229, 10230, 10233, 10238, 10248, 10251, 10252, 10253, 10254, 10256, 10259, 10272, 10345, 10346
Perdio	10353
Perfekt	10353
Philco	10034, 10044, 10047, 10048, 10049, 10050, 10052, 10058, 10078, 10229, 10252, 10254, 10353



TV Codes (including TV/DVD, TV/VCR, TV/DVD/VCR)	
Philips	10029, 10030, 10031, 10032, 10033, 10034, 10035, 10044, 10047, 10048, 10050, 10052, 10058, 10072, 10074, 10104, 10134, 10177, 10187, 10250, 10258, 10282, 10352, 10353
Philips Magnavox	10031, 10034, 10072, 10073
Phoenix	10353
Phonola	10250, 10353
Pilot	10047, 10064, 10229, 10252, 10254, 10259, 10450, 10451, 10452, 10453, 10454
Pioneer	10047, 10049, 10212, 10353
Pionier	10353
Plantron	10353
Plasmsync	10165
Playsonic	10353
Polaroid	10075, 10100, 10109, 10136, 10145, 10190, 10295, 10306, 10310
Polestar	10441
Portland	10047, 10048, 10049, 10053, 10064, 10231, 10252, 10259, 10352
Powerpoint	10353
Praxis	10443
Price Club	10062
Prima	10117, 10148, 10213, 10221, 10291
Princeton	10219, 10286
Prism	10057
Profitronic	10353
Proline	10353
Proscan	10016, 10230
Prosonic	10352, 10353

TV Codes (including TV/DVD, TV/VCR, TV/DVD/VCR)	
Protech	10277, 10353
Proton	10047, 10049, 10052, 10248, 10255, 10263, 10272
Protron	10106, 10309
Proview	10120, 10136, 10295
Provision	10353
Pulsar	10020, 10047, 10228, 10252
Pye	10250, 10352, 10353
Qingdao	10455, 10457, 10462
Quasar	10057, 10235, 10264, 10285, 10343
Quelle	10249, 10266, 10281, 10351, 10353, 10437
Radio Shack/Realistic	10016, 10047, 10049, 10052, 10054, 10061, 10064, 10065
Radiola	10250, 10353
Radiomarelli	10353
RadioShack	10016, 10229, 10230, 10234, 10252, 10254, 10256, 10259, 10265, 10272, 10324, 10353
Radiotone	10353
RBM	10266
RCA	10016, 10017, 10018, 10047, 10048, 10049, 10068, 10077, 10081, 10188, 10230, 10238, 10251, 10252, 10345
Realistic	10016, 10229, 10234, 10252, 10254, 10256, 10259, 10265, 10272
Recor	10353
Rectiligne	10353
Reflex	10353
Revox	10353

TV Codes (including TV/DVD, TV/VCR, TV/DVD/VCR)	
Rex	10277
RFT	10353
Rhapsody	10246, 10274
R-Line	10353
Roadstar	10277, 10353
Rowa	10429
Runco	10020, 10212, 10218, 10228, 10229, 10254
Ruyi	10457, 10459, 10461
Saige	10457, 10460
Saisho	10277, 10351
Saivod	10353
Sampo	10047, 10049, 10064, 10065, 10161, 10206, 10229, 10254, 10256, 10259, 10263, 10292
Samsung	10026, 10027, 10028, 10047, 10048, 10049, 10052, 10062, 10064, 10065, 10127, 10128, 10132, 10137, 10138, 10168, 10229, 10238, 10252, 10254, 10256, 10258, 10265, 10272, 10277, 10353
Samsux	10259
Sanjian	10462
Sansei	10280
Sansui	10078, 10107, 10236, 10324, 10353
Sanyo	10047, 10048, 10097, 10192, 10202, 10270, 10275, 10345, 10351
Sanyuan	10360, 10362, 10366, 10367, 10368, 10378, 10380, 10457, 10460, 10461
SBR	10250, 10353
Sceptre	10123
Schneider	10353



TV Codes (including TV/DVD, TV/VCR, TV/DVD/VCR)	
Scimitsu	10252
Scotch	10049, 10272
Scott	10047, 10049, 10052, 10054, 10055, 10150, 10234, 10252, 10272, 10273
Sears	10016, 10034, 10042, 10044, 10047, 10049, 10055, 10059, 10067, 10160, 10230, 10233, 10265, 10270, 10272, 10273, 10324, 10346
Seg	10277, 10353
SEI	10249, 10353
SEI-Sinudyne	10353
Semivox	10234
Shancha	10457, 10462
Shangguangdian	10445
Shanghai	10359, 10360, 10362, 10363, 10366, 10367, 10368, 10376, 10378, 10380, 10384, 10385, 10386, 10387, 10392, 10457, 10460, 10461, 10462, 10467
Shanshui	10358
Shaofeng	10356, 10360, 10366, 10457, 10459, 10461
Sharp	10022, 10023, 10024, 10025, 10047, 10049, 10052, 10061, 10064, 10103, 10232, 10259, 10268
Shen Ying	10231
Shencai	10362, 10368, 10376, 10384, 10385, 10392, 10460, 10462
Sheng Chia	10232, 10335
ShengCai	10386, 10448
Shengli	10456
Shenyang	10360, 10362, 10368, 10376, 10381, 10382,

TV Codes (including TV/DVD, TV/VCR, TV/DVD/VCR)	
	10457, 10460, 10462
Sherwood	10460
Shintoshi	10353
Shivaki	10353
Shogun	10047, 10252
Shuyuan	10422
Siemens	10281, 10353
Signature	10045
Signet	10306
Silva	10353
Silva Schneider	10353
SIM2 Multimedia	10308
Simpson	10050
Singer	10353
Sinudyne	10249, 10353
Sky	10258, 10353
Skygiant	10234
Skyworth	10360, 10368, 10376, 10381, 10382, 10389, 10390, 10392, 10397, 10409, 10413, 10415, 10420, 10432, 10457, 10462
Solavox	10353
Songbai	10460
SongRi	10448
Soniko	10353
Sonitron	10275
Sonneclair	10353
Sonoko	10353
Sonolor	10275
Sontec	10353
Sony	10000, 10001, 10002, 10003, 10004, 10005, 10046, 10071, 10084, 10130, 10172, 10249, 10324, 10351, 10353
Sound & Vision	10352
Soundesign	10047, 10049, 10050, 10054, 10055, 10234,

TV Codes (including TV/DVD, TV/VCR, TV/DVD/VCR)	
	10272, 10273
Soundwave	10353
Sova	10309
Sowa	10334, 10338
SOYO	10180, 10319
Spectricon	10248
Spectroniq	10295
Squareview	10042, 10067
Srypton	10353
SSS	10047, 10054, 10234, 10252
Standard	10352, 10353
Starlite	10054, 10234, 10353
Strato	10353
Studio Experience	10222
Sunstar	10353
Sunwood	10353
SuperScan	10041, 10232, 10297
SuperTech	10353
Supre-Macy	10066, 10261
Supreme	10046
SVA	10145, 10247, 10283, 10288
Sylvania	10034, 10035, 10039, 10040, 10041, 10042, 10043, 10044, 10047, 10049, 10050, 10058, 10133, 10229, 10254
Symphonic	10041, 10042, 10054, 10067, 10234, 10324
Synco	10231, 10280, 10329, 10334, 10335, 10339
Syntax	10105, 10243, 10303, 10305, 10311
Syntax-Brillian	10105, 10160
Sysline	10353
Tacico	10231, 10339
Tactus	10348
Tai Wah	10444



TV Codes (including TV/DVD, TV/VCR, TV/DVD/VCR)	
Taishan	10360, 10362, 10368, 10370, 10371, 10372, 10373, 10374, 10379, 10457, 10460
Tandy	10232
Tantec	10348
Tashiko	10353
Tatung	10147, 10179, 10241, 10248, 10262, 10264, 10307, 10322, 10331, 10334, 10338, 10348, 10351
TCL	10383, 10384, 10389, 10390, 10398, 10410, 10420, 10425, 10429, 10463
Teac	10277, 10279, 10353
Tec	10353
Tech Line	10353
Technics	10057, 10235
Technol Ace	10273
Technovision	10446
Techview	10223, 10296
Techwood	10047, 10049, 10057, 10248, 10265
Teco	10331, 10335, 10339
Teknika	10034, 10044, 10045, 10047, 10048, 10049, 10050, 10052, 10053, 10054, 10055, 10062, 10064, 10231, 10234, 10238, 10252, 10259, 10265, 10273
Telecaption	10063
Telecor	10353
Telefunken	10027, 10265, 10353
Telefusion	10353
Telegazi	10353
Telesonic	10353

TV Codes (including TV/DVD, TV/VCR, TV/DVD/VCR)	
Telestar	10353
Teletech	10353
Television	10353
Tennessee	10353
Tensai	10352, 10353
Tera	10255
Tevion	10353
Texet	10352
Thomas	10324
Thomson	10016, 10353
Thorn	10348, 10353
Thorn-Ferguson	10438
Tiane	10457
TMK	10047, 10049, 10265, 10272
TNCi	10228
TOBO	10460, 10462
Tokai	10352, 10353
Tongguang	10376, 10384, 10385, 10392, 10462
Tophouse	10234
Toshiba	10006, 10007, 10008, 10009, 10062, 10063, 10079, 10082, 10083, 10087, 10090, 10091, 10212, 10233, 10238, 10245, 10257, 10266, 10285
Tosonic	10274
Totevision	10064, 10259
Trans Continens	10353
Transonic	10353
Trical	10268
Trutech	10146
Tuntex	10231, 10330
TVS	10078, 10236
Uher	10352, 10353
Ultra	10278
Ultravox	10353
Unic Line	10353

TV Codes (including TV/DVD, TV/VCR, TV/DVD/VCR)	
United	10353
Universal	10056, 10353
Universum	10277, 10281, 10351, 10353
Univox	10353
US Logic	10307
Vector Research	10229, 10254
Vegavox	10439
Vestel	10353
Vexa	10353
Vibrant	10348
Victor	10036, 10059
Video Concepts	10267
Videocon	10436
Videosystem	10353
Vidikron	10034, 10044, 10212, 10276
Vidtech	10047, 10048, 10049, 10252, 10257, 10272
Viewsonic	10094, 10110, 10191, 10203, 10204, 10205, 10206, 10297, 10299, 10314
Viking	10066, 10261
Viore	10149, 10304
Visart	10312
Visco	10157
Vision	10353
Vito	10434
VIZIO	10047, 10094, 10122, 10166, 10241, 10297, 10299, 10322, 10323, 11000
Vortec	10353
Waltham	10353
Wards	10016, 10034, 10044, 10045, 10047, 10048, 10049, 10055, 10056, 10058, 10061, 10229, 10252, 10253, 10254, 10265, 10272, 10273
Warumaia	10458



TV Codes (including TV/DVD, TV/VCR, TV/DVD/VCR)	
Watson	10353
Wega	10353
Wega Color	10435
Weipai	10460
Westinghouse	10094, 10098, 10186, 10299
Wharfedale	10353
White Westinghouse	10076, 10078, 10236, 10353
WinBook	10317
Wyse	10316
Xiahua	10360, 10362, 10367, 10368, 10370, 10376, 10380, 10384, 10385, 10390, 10392, 10425, 10457, 10460, 10462
Xiangyang	10376, 10384, 10385, 10392, 10462

TV Codes (including TV/DVD, TV/VCR, TV/DVD/VCR)	
Xiangyu	10362, 10368, 10375, 10460
Xihu	10360, 10366, 10367, 10376, 10378, 10380, 10384, 10392, 10422, 10457, 10461, 10462
Xinaghai	10460, 10462
Xingfu	10362, 10368, 10460
Xinghai	10362, 10368, 10376, 10384, 10385, 10392
Xinsida	10467
Xuelian	10359, 10366, 10367, 10378, 10380, 10386, 10387, 10461
Yamaha	10047, 10048, 10049, 10229, 10252, 10254
Yamishi	10353

TV Codes (including TV/DVD, TV/VCR, TV/DVD/VCR)	
Yapshe	10341
YingGe	10448, 10460, 10461
Yoko	10277
Yonggu	10460, 10461
Youlanasi	10457, 10461
Yousida	10460
Yuhang	10362, 10368, 10460
Zenith	10019, 10020, 10021, 10045, 10047, 10069, 10078, 10198, 10228, 10231, 10236, 10245, 10272, 10324
Zhuhai	10362, 10368, 10379, 10460
Zonda	10248

Cable Box Codes (including Cable / PVR Boxes)	
ABC	40030, 40031, 40032, 40034, 40053, 40107, 40126, 40127
Adelphia	40001
Allegro	40038
Antronix	40036, 40037
Apache	40124
Archer	40037, 40038, 40123
AT&T	40003
BBT	40129
Belcor	40125
Bell & Howell	40033
Bell South	40113
Cable Star	40125
Cable Vision	40005
Cabletenna	40036
Cableview	40035
Century	40038
Citizen	40038, 40118

Cable Box Codes (including Cable / PVR Boxes)	
Clearmaster	40112
ClearMax	40112
Colour Voice	40039
Comcast	40000, 40007
Comtronics	40040
Contec	40041
Coolmax	40112
COX	40000
Daeryung	40071
Digi	40117
Director	40007
Dumont	40117
Eastern	40042
Emerson	40123
Everquest	40040, 40108
Focus	40111
Garrard	40038
GC Electronics	40037, 40125
GE	40030, 40031

Cable Box Codes (including Cable / PVR Boxes)	
Gehua	40007
Gemini	40043, 40108, 40123
General Instrument	40007, 40031, 40105
GoldStar	40040, 40109
Goodmind	40123, 40124
Hamlin	40044, 40045
Hitachi	40031
Hytex	40126
Illico	40119
Jasco	40038, 40108
Jerrold	40007, 40031, 40043, 40053, 40067, 40105, 40108
LG	40116
Linsay	40132
Magnavox	40046
MegaCable	40007
Memorex	40047, 40107



Cable Box Codes (including Cable / PVR Boxes)	
Motorola	40000, 40003, 40007, 40072, 40105
Movie Time	40048
Multitech	40112
Multivision	40120
NEC	40033
NET Brazil	40070
Nexus	40124
Nova Vision	40121
Novaplex	40134
NSC	40048
Oak	40041, 40126
Pace	40006, 40110
Panasonic	40051, 40107
Panther	40117
Paragon	40107
Philips	40038, 40039, 40046
Pioneer	40002, 40049, 40071, 40109
Popular Mechanics	40111
Prelude	40124
Proscan	40030, 40031
Pulsar	40107
Quasar	40107
RadioShack	40108, 40112, 40123
RCA	40035
Realistic	40037
Recoton	40111

Cable Box Codes (including Cable / PVR Boxes)	
Regal	40045
Regency	40042
Rembrandt	40031
Rogers	40119
Runco	40107
Samsung	40006, 40040, 40049, 40069, 40109
Scientific Atlanta	40001, 40002, 40003, 40034, 40071, 40106
Signal	40040, 40043, 40108
Signature	40031
SL Marx	40040
Sony	40005, 40114
Standard Component	40050
Starcom	40043, 40053, 40108
Stargate	40040, 40043, 40108, 40123, 40124
Starquest	40043, 40108
StarSight	40131
Supercable	40105
Supermax	40112
Sylvania	40127
Tandy	40128
Telecaption	40130
TeleView	40040
Texscan	40127
TFC	40133

Cable Box Codes (including Cable / PVR Boxes)	
TIME WARNER	40004
Timeless	40040
Tocom	40032
Torx	40115
Toshiba	40107
Trans PX	40105
Tristar	40112
TS	40115
Tusa	40043, 40108
TV86	40048
US Electronics	40105
Unika	40036, 40037, 40038
United Artists	40126
United Cable	40053
Universal	40036, 40037, 40038, 40125
V2	40112
Videotron	40122
View Star	40041, 40046, 40048
Viewmaster	40112
ViewStar	40128
Vision	40112
Vortex View	40112
Zenith	40052, 40068, 40107, 40113
Zentek	40111



Satellite Receiver Codes (including Sat / PVR Boxes)	
AccessHD	40096
Alpha Digital	40096
AlphaStar	40064
Apex Digital	40103
Artec	40092
CaptiveWorks	40088
Channel Master	40097
Chaparral	40056
Coolsat	40089
Coship	40093
Crossdigital	40146
Digital Stream	40102
DirecTV	40014, 40015, 40016, 40017, 40018, 40019, 40020, 40023, 40024, 40025, 40028, 40029, 40054, 40055, 40077, 40078, 40079, 40135, 40136, 40138, 40141
Dish Network System	40008, 40009, 40010, 40011, 40021, 40137, 40139, 40144
Dishpro	40137, 40139, 40144
Drake	40057
Echostar	40008, 40021, 40137, 40139, 40144, 40145
Expressvu	40139, 40144, 40145
GE	40012, 40013, 40098
General Instrument	40058, 40142

PVR Codes	
ABS	20410
Alienware	20410
AT&T	20245
Bang & Olufsen	20412
CyberPower	20410

Satellite Receiver Codes (including Sat / PVR Boxes)	
GOI	40144
Goodmind	40098
Hisense	40143
Hitachi	40029, 40065
HTS	40144
Hughes Network Systems	40016, 40018, 40019, 40023, 40025, 40054, 40135
Humax	40090
Ilo	40143
Insignia	40082
Jerrold	40142
JVC	40008, 40021, 40144
Lasonic	40099
LG	40082
Magnavox	40028, 40094
Memorex	40028
MicroGem	40100
Mitsubishi	40023, 40085
Motorola	40140, 40142
Next Level	40142
Panasonic	40017, 40083
Pansat	40086
Paysat	40028
PCT	40097
Philco	40094
Philips	40016, 40023, 40025, 40027, 40028, 40079, 40135
Pioneer	40016
Primestar	40063

PVR Codes	
Dell	20410
DirecTV	20238, 20240, 20241, 20243, 20405, 20406, 20409, 20411
Dish Network	20408
Dishpro	20408

Satellite Receiver Codes (including Sat / PVR Boxes)	
Proscan	40012, 40013, 40138
Proton	40143
RadioShack	40142
RCA	40012, 40013, 40014, 40025, 40055, 40073, 40075, 40077, 40078, 40080, 40091
Realistic	40059
Samsung	40016, 40018, 40024, 40025, 40026, 40081
Sharp	40084
Sonicview	40101
Sony	40015, 40022, 40074, 40076, 40136
Star Choice	40140, 40142
STS	40066
STS1	40060
STS3	40061
STS4	40062
Tivax	40096
Tivo	40016, 40025
Toshiba	40019
UltimateTV	40136
Uniden	40028
US Digital	40143
Viewsat	40087
Voom	40142
Winegard	40104
Zenith	40020, 40082
Zentech	40095

PVR Codes	
Echostar	20408
Expressvu	20408
Gateway	20410
GOI	20408
Hewlett Packard	20410
Howard	20410



PVR Codes	
Computers	
HTS	20408
Hughes Network Systems	20240, 20238, 20241, 20243, 20407
Humax	20238
Hush	20410
iBUYPOWER	20410
JVC	20238, 20408
Linksys	20410
Media Center PC	20410
Microsoft	20410
Mind	20410
Niveus Media	20410
Northgate	20410
Panasonic	20245
Philips	20238, 20240, 20241, 20242, 20243, 20407
RCA	20238, 20243, 20407, 20409, 20411
ReplayTV	20244
Samsung	20241, 20243, 20407
Sonic Blue	20244
Sony	20239, 20410
Stack	20410
Systemax	20410
Tagar Systems	20410
Tivo	20238, 20239, 20240, 20242, 20243
Toshiba	20410
Touch	20410
UltimateTV	20411
Viewsonic	20410
Voodoo	20410
ZT Group	20410

Blu-Ray DVD Player Codes	
Denon	20143, 20144
Insignia	20142
LG	20132
Marantz	20145, 20146
Panasonic	20128, 20129, 20130, 20197, 20198
Pioneer	20134, 20147
Samsung	20015, 20125
Sharp	20139, 20140, 20141
Sony	20005
VIZIO	22000

DVD Player Codes	
Accele Vision	20137
Accurian	20311
Advent	20288
Aiko	20348
Aiwa	20207
Akai	20161, 20282, 20317
Akishi	20349
Akustic	20348
Alco	20286
Allegro	20306
Alpine	20152
Amphion Media Works	20151, 20330
AMW	20151
Anam	20392
Aodeiong	20358
Apex	20024, 20025, 20026, 20027, 20085, 20111, 20300, 20301
Apple	20189
Arrgo	20307
Aspire	20209, 20290
Astar	20181
ATLM	20369
Audiovox	20106, 20116, 20286
Axion	20162

DVD Player Codes	
Bang & Olufsen	20302
Blaupunkt	20136, 20301
Blue Parade	20298
Bose	20076, 20086, 20393, 20394
BOSS	20138
Boston Acoustics	20331
Brand	20383
Broksonic	20007, 20282
Caixing	20389
California Audio Labs	20284
Cambridge Sound Works	20203
Caravell	20362
CAVS	20210
Changhong	20285, 20345
CineVision	20114, 20306
Clarion	20154
Classic	20131
Coby	20087, 20095, 20123, 20289
Conic	20370
Curtis	20095
Curtis Mathes	20308
CyberHome	20028, 20070, 20307, 20323, 20326
Cytron	20160
Daewoo	20093, 20306, 20317
Dayu	20388
DCS	20363
Denca	20367
Denon	20108, 20115, 20143, 20144, 20284
Desay	20185
Diamond Vision	20237
Dihe	20338
Ding Tian	20342
Disney	20090, 20096
Dual	20172



DVD Player Codes	
Durabrand	20309
DVD2000	20295
Dynex	20193
Eclipse	20126
Electrohome	20395
Emerson	20041, 20135, 20283, 20303, 20310
Enterprise	20303
ESA	20182, 20310
Fisher	20168, 20304
Funai	20310
Gateway	20327
GE	20082, 20296, 20301
Gewang	20361
GFM	20149
Giec	20355
Go Video	20306, 20327, 20396
GoldStar	20167
GPX	20112
Gradiente	20158, 20284
Greenhill	20301
Grundig	20297
Haier	20165, 20340
Haitai	20364
Haoji	20384
Harman/Kardon	20124, 20305
Hisense	20344
Hitachi	20013, 20232
Hiteker	20300
Huabao	20375
Huabaojamo	20334
iLive	20205
Ilo	20159
iLuv	20174
Initial	20159, 20301
Insignia	20142, 20150, 20164, 20202, 20310
Integra	20285, 20298

DVD Player Codes	
iSymphony	20190
Jamo	20206
JBL	20104, 20305
Jensen	20171, 20289, 20397
Jieke	20390
Jingewangpai	20375
Jingwei	20336
Jinwang	20377
Jugao	20359
JVC	20029, 20030, 20031, 20032, 20033, 20034, 20035, 20036, 20037, 20098, 20119, 20195, 20299
Jwin	20169, 20219
Kawasaki	20286
KEF	20398
Kenwood	20386
Kenwood	20122, 20284
Ketai	20376
KLH	20286, 20301
Klipsch	20332
Konka	20316
Koss	20101, 20199, 20292
Lafayette	20351
Landel	20312
Lasonic	20155, 20220, 20399
Legend-V	20365
Lenox	20291, 20309
Lexicon	20314
LG	20091, 20100, 20117, 20132, 20180, 20303, 20306
Linshuma	20378
Liquid Video	20292
LiteOn	20102, 20235, 20236, 20311, 20327
Loewe	20313, 20320
Longzhipai	20354

DVD Player Codes	
Magnavox	20081, 20142, 20283, 20294, 20297, 20310
Malata	20346
Marantz	20145, 20146, 20297
Maxview	20368
McIntosh	20211
Memorex	20090, 20282
Microsoft	20296
Mintek	20159, 20301
Mitsubishi	20092, 20295
Mitsui	20353
Mitsu	20348
NAD	20156, 20333
Nakamichi	20170, 20400
Napa	20350
Nesa	20301
Next Base	20312
NexxTech	20187
Niro	20401
Norcent	20095, 20221
Okon	20385
Onkyo	20099, 20110, 20285, 20294
Oppo	20163, 20188
Oritron	20101, 20292
Other Brand	20373
Pai Gao	20360
Panasonic	20016, 20017, 20018, 20019, 20020, 20021, 20022, 20023, 20073, 20075, 20080, 20118, 20128, 20129, 20130, 20197, 20198, 20222, 20229, 20230, 20232, 20233, 20284, 20294
Panda	20379
Parasound	20212
Philco	20286, 20351
Philips	20006, 20040, 20041, 20081, 20294, 20297,



DVD Player Codes	
	20314
Pioneer	20042, 20043, 20044, 20045, 20134, 20147, 20234, 20298
Polaroid	20027, 20133, 20208, 20402
Polk Audio	20297
Portland	20317
Power Sound	20348
Prima	20192, 20403
Primas	20335
Princeton	20315
Proceed	20300
Proscan	20082, 20296
Protron	20213
Pye	20166
Qinghuatongfang	20382
Qisheng	20372
Qixing	20391
Qwestar	20101
RCA	20038, 20039, 20082, 20286, 20296, 20298, 20301
Regent	20291
Rio	20306
Rotel	20214, 20299
Rowa	20287
Royal	20351
Saba	20404
Sampo	20157, 20325, 20328
Samsung	20011, 20012, 20013, 20014, 20015, 20077, 20079, 20083, 20088, 20125, 20176, 20191, 20231, 20284
Sansui	20127, 20282
Sanyo	20200, 20282, 20304
Sast	20336
Sensory Science	20327
Shanshui	20374

DVD Player Codes	
Sharp	20120, 20139, 20140, 20141, 20204, 20328
Sharper Image	20323
Sherwood	20203, 20317
Shinco	20136
Shinsonic	20159, 20293
Shumaling	20337
Sigma Designs	20315
Skyworth	20375
Sonashi	20356
Sonic Blue	20306, 20396
Sonico	20352
Sony	20000, 20001, 20002, 20003, 20004, 20005, 20071, 20074, 20078, 20084, 20089, 20177, 20178, 20179, 20194, 20223, 20224, 20225, 20293
Sowa	20347
Spectroniq	20215
Sungale	20184
Superscan	20103, 20283
Supersonic	20351
SVA	20319
Sylvania	20041, 20103, 20148, 20149, 20283, 20310, 20329
Symphonic	20103, 20183
Tatung	20366
TCL	20371
Teac	20136, 20286
Technics	20284
Techwood	20153
Terapin	20321
Theta Digital	20298
Tianli	20343
Toshiba	20006, 20007, 20008, 20009, 20010, 20072, 20105, 20109, 20121, 20196, 20226, 20227,

DVD Player Codes	
	20228, 20282, 20294
Tredex	20318
Trutech	20186, 20218
Tsinghuatongfang	20357
Tview	20173
Urban Concepts	20294
US Logic	20159
Venturer	20201, 20286
Victor	20380
VIZIO	20322, 20324, 22000
Vocopro	20175, 20216
VocoStar	20217
Wanbao	20355
Wanyan	20346
Weifa	20381
Westinghouse	20113
Xbox	20296
Xianpai	20338
Xindai	20387
Yamaha	20016, 20107, 20284, 20297
YMT	20356
Youbishen	20341
Yuxing	20339
Zenith	20091, 20094, 20097, 20294, 20303, 20306

Amplifier / Receiver / Tuner Codes	
Accurian	30164
ADA	30165
ADC	30133
Adcom	30104
Aiwa	30087, 30162, 30260
Alco	30139
Altec Lansing	30166
AMC	30167
Amphion Media Works	30140, 30145
Amplifier	30200



Amplifier / Receiver / Tuner Codes	
Technologies	
AMW	30140
Anam	30135, 30149
Antex	30168
Apex	30099
Apple	30169
Aragon	30201
Atlantic Technology	30170
Audio Access	30202
Audio Authority	30203
Audio Tron	30171
Audiophase	30204
AudioSource	30205
Audiotronic	30136
Audiovox	30098, 30139
B & K	30105
Bang & Olufsen	30144
Blaupunkt	30206
Bondstec	30207
Bose	30062, 30076, 30150, 30151, 30261
Boston Acoustics	30146
Cambridge Soundworks	30121
Capetronic	30133, 30208
Carver	30136, 30162
Casio	30209
Celestion	30210
Clarion	30211
Classic	30109
Clatronic	30212
Coby	30092, 30213, 30262
Compaq	30172
Creative	30173
Crown	30214
Curtis	30103, 30215
Curtis Mathes	30129
Daewoo	30216

Amplifier / Receiver / Tuner Codes	
DBX	30174
Dell	30217
Delphi	30218
Denon	30051, 30052, 30053, 30054, 30055, 30102
D-Link	30175
EAD	30219
Eclipse	30220
Elan	30176
Electrohome	30152
Emerson	30112, 30256
Fahrenheit	30221
Felston	30177
Fonmix	30163
Fosgate	30170
GE	30046, 30128
Go Video	30153
GPX	30100, 30257
Griffin	30178
Hanwah	30222
Harman/Kardon	30130, 30162
iHome	30263
iLive	30124
iLuv	30258
Imerge	30179
Inkel	30223
Insignia	30120
Insten	30180
Integra	30132
iPort	30181
iSymphony	30125, 30258
Jamo	30126
JBL	30097
Jensen	30154
Jerrold	30182
JVC	30031, 30032, 30033, 30034, 30035, 30259
Jwin	30265
KEF	30155

Amplifier / Receiver / Tuner Codes	
Kenwood	30036, 30037, 30038, 30039, 30040, 30065, 30071, 30077, 30137
KLH	30139
Klipsch	30147
Koss	30117, 30138
Krell	30110
Lasonic	30156
Left Coast	30130
Lexicon	30224
LG	30093, 30264
Ligitek	30183
Linn	30162
Luxman	30184
LXI	30225
Magnadyne	30226
Magnat	30227
Magnavox	30066, 30133, 30136, 30162
Magnum Dynalab	30228
Marantz	30106, 30130, 30136, 30162
Mark Levinson	30185
Matrix Audio	30229
MCE	30230
McIntosh	30111
Mediacom	30231
Memorex	30186
Meridian	30232
Micromega	30233
Mitsubishi	30096
Motorola	30234
Musical Fidelity	30235
NAD	30143, 30148
Nakamichi	30142, 30157
NEC	30131, 30236
Netgear	30187
Nikko	30237
Niles	30238
Niro	30158



Amplifier / Receiver / Tuner Codes	
Nubert	30188
Nuvo	30239
Olive	30189
Omnifi	30190
Onkyo	30041, 30042, 30043, 30044, 30045, 30067, 30069, 30070, 30075, 30080, 30091
Optimus	30129, 30133, 30134, 30135
Oritron	30138
Panasonic	30019, 30020, 30021, 30022, 30023, 30115, 30116, 30255
Parasound	30113
Penney	30240
Performance Technique	30241
Philips	30094, 30130, 30136, 30162
Pioneer	30024, 30025, 30026, 30027, 30028, 30029, 30030, 30060, 30063, 30078, 30127, 30129, 30133, 30134
Polaroid	30159
Polk Audio	30107, 30130, 30162
Prima	30160
Primare	30242
Proscan	30046
RCA	30046, 30047, 30048, 30049, 30088, 30129, 30133, 30134, 30135, 30139
Revox	30243
Rio	30141
Roku	30191
Russound	30244
Saba	30161
Samsung	30073
Sangean	30245
Sansui	30162, 30246

Amplifier / Receiver / Tuner Codes	
Sanyo	30118
Sharp	30101, 30122, 30259
Sherwood	30089, 30123
Shure	30131
SII	30247
Sonic Blue	30141, 30153
Sony	30000, 30001, 30002, 30003, 30004, 30005, 30006, 30007, 30056, 30057, 30058, 30059, 30061, 30064, 30074, 30077, 30082, 30083, 30084, 30085, 30086
Soundesign	30128
Soundmatters	30114
Soundstream	30248
Spatializer	30192
SpeakerCraft	30249
Stereophonics	30134
Sunfire	30137
SuperTech	30250
Teac	30135, 30139, 30258
Technics	30022, 30050
Techwood	30251
Teknika	30193
Thorens	30136
Tivoli Audio	30194
Topline	30252
Toshiba	30108
Universum	30253
Vector Research	30254
Velodyne	30195
Venturer	30119, 30139
Wards	30127, 30128, 30162
Xantech	30196
Xitel	30197
Yamaha	30008, 30009, 30010, 30011, 30012, 30013,

Amplifier / Receiver / Tuner Codes	
	30014, 30015, 30016, 30017, 30018, 30068, 30072, 30079, 30081, 30095, 30132
Zektor	30198
Zenith	30090
Zon	30199

Audio Accessory Codes (including CD Players and Soundbars)	
Acoustic Research	30294
ADC	30291
ADS	30295
Aiwa	30283
Akai	30292
ASI	33000
Audiophase	30282
Bose	30284
California Audio Labs	30296
Cambridge Audio	30297
Capetronic	30298
Carrera	30299
Carver	30300, 30331, 30332
Cary Audio Design	30301
CCE	30302
Clarion	30303
Classic	30304
Coby	30287
Cox Cable	33001
Creative	30305
DBX	30306
Denon	30267
Direct TV	33002
Dish Network	33003
DKK	30328
DMX Electronics	30331



Audio Accessory Codes (including CD Players and Soundbars)	
Dynamic Bass	30332
Emerson	30279
Garrard	30307
Genexxa	30329
GPX	30280
Harman/Kardon	30273
Hitachi	30308
iHome	30288
iLuv	30286
Inkel	30309
iSymphony	30286
JVC	30269, 30281
Jwin	30290
Kenwood	30310, 30330
KLH	30311
Koss	30312
Krell	30331
LG	30289
Linn	30331
Luxman	30293
Magnavox	30313
Marantz	30314
Mark Levinson	30315
McIntosh	30316
Memorex	30317
Miro	30328
Mission	30331
Musical Fidelity	30318
NAD	30319
Nakamichi	30320
NEC	30321
Nikko	30322
NSM	30331
Onkyo	30268
Optimus	30328, 30329, 30332
Panasonic	30278
Philips	30275, 30276
Pioneer	30272

Audio Accessory Codes (including CD Players and Soundbars)	
Polk Audio	30331
Proton	30331
QED	30331
Quad	30331
RCA	30266
Realistic	30332
Rotel	30331
SAE	30331
Samsung	30323
Sansui	30331
Sanyo	30324
SAST	30331
Sharp	30281
Sherwood	30325
Silsonic	30330
Sonic Frontiers	30331
Sony	30270, 30271, 30274
Super Atlas	33004
TAG McLaren	30331
Teac	30286
Technics	30277
Techwood	30326
Tivoli Audio	30327
VIZIO	33005
Wards	30331
Yamaha	30285
Zonda	30331

VCR Codes	
ABS	20410
Adventura	20050, 20250
Aiwa	20050, 20250
Akai	20061
Alienware	20410
American High	20249
Apex	20415
Asha	20054, 20247
Audio	20058

VCR Codes	
Dynamics	
Audiovox	20248, 20267
Beaumarck	20054, 20247
Bell & Howell	20246
Broksonic	20279
Calix	20248
Candle	20247, 20248
Canon	20249
CineVision	20280
Citizen	20247, 20248, 20420
Colortyme	20058
Colt	20417
Craig	20054, 20247, 20248
Curtis Mathes	20058, 20247, 20249
Cybernex	20054, 20247
CyberPower	20410
Daewoo	20060, 20250, 20420
Davidson	20050
DBX	20058
Dell	20410
Denon	20055
DIRECTV	20407
Durabrand	20067
Dynatech	20050, 20250
Electrohome	20052, 20248
Electroponic	20248
Emerson	20050, 20052, 20062, 20248, 20249, 20250, 20420
Fisher	20246
Fuji	20249
Funai	20050, 20062, 20250
Garrard	20050, 20250
Gateway	20410
GE	20054, 20247, 20249, 20418
Go Video	20054
GoldStar	20058, 20066,



VCR Codes	
	20248, 20419
Gradiente	20050, 20250
Harley Davidson	20250
Harman/Kardon	20058
Headquarter	20246
Hewlett Packard	20410
Hitachi	20050, 20055
Howard Computers	20410
Hughes Network Systems	20055, 20407
Humax	20407
Hush	20410
iBUYPOWER	20410
Instant Replay	20249
JC Penney	20058, 20246, 20247, 20248, 20249
JCL	20249
JVC	20056, 20057, 20058, 20246, 20254, 20264, 20265, 20266, 20268, 20269, 20270, 20271
Kenwood	20058, 20246
Kodak	20248, 20249
LG	20248
Linksys	20410
Lloyd's	20050, 20250
LXI	20248
Magnasonic	20062, 20420
Magnavox	20050, 20062, 20067, 20069, 20249
Magnin	20054, 20248, 20418
Marantz	20058, 20246, 20249
Marta	20248
Matsushita	20249
Media Center PC	20410
MEI	20249

VCR Codes	
Memorex	20050, 20054, 20067, 20246, 20247, 20248, 20249, 20250, 20414, 20416, 20419
MGA	20052, 20054, 20418
MGN Technology	20054, 20247
Microsoft	20410
Mind	20410
Minolta	20055
Mitsubishi	20052, 20255
Motorola	20249
MTC	20050, 20054, 20247
Multitech	20050, 20247, 20250
NEC	20058, 20246
Nikko	20248
Niveus Media	20410
Noblex	20054, 20247
Northgate	20410
Olympus	20249
Optimus	20062, 20248, 20416
Optonica	20065
Orion	20258, 20414
Panasonic	20017, 20018, 20019, 20046, 20249, 20273, 20274, 20413, 20416
Penney	20054, 20055, 20418, 20419
Pentax	20055
Philco	20249
Philips	20065, 20249, 20256, 20278, 20407
Philips Magnavox	20256
Pilot	20248
Polaroid	20415
Profitronic	20054
Pulsar	20067

VCR Codes	
Pye	20281
Quarter	20246
Quartz	20246
Quasar	20249, 20416
RadioShack	20050, 20065, 20248, 20249, 20065, 20246, 20247, 20250
Radix	20248
Randex	20248
RCA	20053, 20054, 20055, 20247, 20249, 20252, 20275, 20276, 20418
Realistic	20050, 20065, 20246, 20247, 20248, 20249, 20250, 20065
ReplayTV	20413
Ricavision	20410
Runco	20067
Samsung	20054, 20059, 20060, 20061, 20247, 20263, 20277, 20407
Sanky	20067
Sansui	20050, 20258, 20414
Sanyo	20054, 20246, 20247, 20418
Scott	20052, 20060
Sears	20050, 20055, 20246, 20248, 20249, 20419
Sharp	20064, 20065, 20257
Shogun	20054, 20247
Singer	20249
Sonic Blue	20413
Sony	20047, 20048, 20049, 20050, 20251, 20253, 20260, 20261, 20262, 20272, 20410
Stack	20410
STS	20055, 20249
SuperScan	20063



VCR Codes	
Sylvania	20050, 20052, 20062, 20063, 20249, 20250
Symphonic	20050, 20062, 20063, 20250
Systemax	20410
Tagar Systems	20410
Tandy	20246
Tashiko	20248
Teac	20050, 20250
Technics	20249
Teknika	20050, 20248, 20249, 20250
Thomas	20050

VCR Codes	
Tivo	20407
TMK	20054, 20247
Toshiba	20051, 20052, 20060, 20259, 20410
Totevision	20054, 20247, 20248
Touch	20410
Unitech	20054, 20247
Vector	20060
Vector Research	20058
Video Concepts	20058, 20060
Videosonic	20054, 20247

VCR Codes	
Viewsonic	20410
Villain	20050
Voodoo	20410
Wards	20050, 20054, 20055, 20065, 20247, 20248, 20249, 20250
XR-1000	20050, 20249, 20250
Yamaha	20058, 20246
Zenith	20050, 20066, 20067, 20068
ZT Group	20410



Limited Product Warranty

VIZIO provides a "ONE-YEAR LIMITED WARRANTY" against manufacturing defects in materials and workmanship to the original purchaser of a new VIZIO display purchased from an authorized VIZIO U.S. reseller and used in the fifty (50) United States or Puerto Rico.

VIZIO's Responsibility

VIZIO displays purchased new from an authorized VIZIO U.S. reseller and that are used in the fifty (50) United States or Puerto Rico are warranted to be free from manufacturing defects in materials and workmanship for one (1) year from the date of the original retail purchase. If the display fails to conform to this limited warranty, VIZIO will, at its option and sole discretion, repair or replace the display.

Labor

During the one-year limited warranty period, VIZIO will provide, when needed, service labor to repair a manufacturing defect. Repairs required on displays which are thirty (30) inches and larger generally will be made "on-site" where the display is installed. The determination for performing the on-site repair is dependent upon the manufacturing defect and is at VIZIO's option and sole discretion. Repairs required on displays which are less than thirty (30) inches generally will be performed at a VIZIO service center.

Parts

Repairs may be made with new or recertified parts, or the entire unit may be replaced with a new or recertified unit, at VIZIO's option and sole discretion. Replacement parts or replacement units provided under this limited warranty are warranted for the remaining portion of the original warranty period, or for ninety (90) days from warranty service or replacement, whichever is later.

How to Obtain Warranty Service

To obtain warranty service, contact VIZIO Technical Support via email at TechSupport@VIZIO.com, via phone at 877-MYVIZIO (877-698-4946), or via postal mail at VIZIO Technical Support, 39 Tesla, Irvine, CA 92618. You must provide the model, serial number, and date of purchase. VIZIO Technical Support is available from 6:00AM to 9:00PM Pacific Time, Monday through Friday, and 10:00AM to 2:00PM Pacific Time, Saturday and Sunday. Please note that holiday hours may vary. For up to date information, please visit www.VIZIO.com.

VIZIO reserves the right to assess all warranty claims and to determine if defects or damages are covered by this limited warranty. In case of a claim that is not covered by this warranty, you will be contacted to determine whether VIZIO should repair the damage for a fee or whether the product should be returned to you as received by the service technician or service center.

Parts and service labor that are VIZIO's responsibility under this limited warranty will be provided without charge. All other service is at the customer's expense. VIZIO reserves the right to charge the customer for any service call for anything not covered by this limited warranty. Before you ask for warranty service, please review your User Manual. You may avoid a service call and a service charge.

Please refer to the reverse side of this page for additional information regarding how to obtain warranty service.

**PLEASE DO NOT RETURN YOUR UNIT TO VIZIO WITHOUT PRIOR
AUTHORIZATION.**

Not Covered

This limited warranty does not cover the following: cosmetic defects; damage, malfunctions or failures resulting from shipping or transit, improper or faulty installation, abuse, operation contrary to furnished instructions, operation on incorrect power supplies, products not supplied by VIZIO, modification, alteration, improper servicing or tampering; damage from fire, water, lightning, power surges, abnormal environmental conditions or other acts of nature; normal wear and tear; unsatisfactory visual or audio performance not caused by a manufacturing defect; or displays with a missing or unreadable serial number. Operation of the display for commercial purposes or in applications or uses for which the display is not intended is not covered by this limited warranty. "Image Sticking", caused by static images on the screen for extended periods and or excessive brightness and contrast levels, is not covered by this



limited warranty. Installation, removal, transportation and reinstallation of a display, and routine maintenance and cleaning, are not covered by this limited warranty.

THERE ARE NO EXPRESS WARRANTIES OTHER THAN THOSE LISTED OR DESCRIBED ABOVE. ANY IMPLIED WARRANTIES, INCLUDING ANY IMPLIED WARRANTY OF MERCHANTABILITY AND FITNESS FOR A PARTICULAR PURPOSE, SHALL BE LIMITED IN DURATION TO THE PERIOD OF TIME SET FORTH ABOVE. VIZIO'S TOTAL LIABILITY FOR ANY AND ALL LOSSES AND DAMAGES RESULTING FROM ANY CAUSE WHATSOEVER, INCLUDING VIZIO'S NEGLIGENCE, ALLEGED DAMAGE, OR DEFECTIVE GOODS, WHETHER SUCH DEFECTS ARE DISCOVERABLE OR LATENT, SHALL IN NO EVENT EXCEED THE PURCHASE PRICE OF THE DISPLAY. VIZIO SHALL NOT BE RESPONSIBLE FOR LOSS OF USE, COMMERCIAL LOSS, LOST REVENUE OR LOST PROFITS, OR OTHER INCIDENTAL OR CONSEQUENTIAL DAMAGES. SOME STATES DO NOT ALLOW LIMITATIONS ON HOW LONG AN IMPLIED WARRANTY MENUS OR THE EXCLUSION OR LIMITATION OF INCIDENTAL OR CONSEQUENTIAL DAMAGES, SO THE ABOVE LIMITATIONS OR EXCLUSIONS MAY NOT APPLY TO YOU.

This warranty gives you specific legal rights, and you may also have other rights, which vary from state to state. This is the only warranty applicable; no one is authorized to extend or modify it or to grant any other warranty on VIZIO's behalf.

Owner's Responsibility

To ensure warranty service, keep the dated bill or sales receipt as evidence of the purchase date and location. This limited warranty applies only to original purchaser and is non-transferable.

Note: Warranty service conditions are subject to change. For the latest Warranty Terms and Conditions and additional information regarding VIZIO's Limited Product Warranty, please see complete details online at www.VIZIO.com.

VIZIO Return Policy

VIZIO's return policy allows for products purchased directly from VIZIO to be returned by the original purchaser during the initial thirty (30) day period following the date of purchase. A VIZIO return authorization number must first be obtained as provided below. The refund will be the purchase price actually paid by the purchaser less a ten percent (10%) restocking fee per each item returned. Shipping and handling are not refundable.

The return authorization number must first be obtained from VIZIO's Customer Service by emailing CustomerSupport@VIZIO.com or by calling 949-428-2525, 6:00AM to 9:00PM Pacific Time, Monday through Friday, and 10:00AM to 2:00PM Pacific Time, Saturday and Sunday. Please note that holiday hours may vary. For up to date information, please visit www.VIZIO.com.

Products must be returned to the address specified by VIZIO Customer Service and must be shipped in the original packaging, with freight prepaid to VIZIO, and must be received in new and unused condition. The return authorization number must be included in the packaging. VIZIO reserves the right to assess fees for any damaged or missing parts in addition to the ten percent (10%) restocking fee.

Return authorization numbers are valid for only fifteen (15) days from issuance. The customer is responsible for and must prepay all shipping charges and shall assume all risk of loss or damage to the product while in transit to VIZIO. If the product is returned to VIZIO (i) without a VIZIO return authorization number, and/or (ii) beyond the fifteen (15) day period, and/or (iii) without proper packaging, VIZIO retains the right to refuse delivery of such return or may return the unit to the customer at the customer's expense and with no refund issued. This return policy does not apply to defective products. Please read VIZIO's Limited Product Warranty for warranty terms and conditions.



On-Site Warranty Repair Procedure

On-Site Warranty Repair generally is performed on repairable displays which are 30 inches and larger.

If VIZIO Technical Support determines that a problem with a display unit may be within the terms and conditions of the VIZIO Limited Product Warranty and that an on-site repair may be performed, the customer will be provided with an on-site repair authorization number and on-site repair instructions. The determination for performing the on-site repair may be dependent upon the manufacturing defect and is at VIZIO's option and sole discretion. Proof of purchase is required to confirm the product is within the one-year limited warranty period and meets the terms and conditions of the VIZIO Limited Product Warranty.

On-site repair service is requested through VIZIO's third-party service provider. After VIZIO provides the customer with the on-site repair (OSR) authorization number, the third-party service provider will contact the customer and will schedule the repair at the customer's location. The total approximate time for the repair process, which includes the repair diagnosis, dispatching the technician, shipping the replacement part(s), and arranging the appointment with the customer, is completed within approximately 3 to 5 business days, pending availability of these factors.

If it is determined the product can not be repaired on-site, the customer will be required to ship the unit to VIZIO's service center, per the below warranty replacement procedure.

VIZIO is not responsible for the de-installation or re-installation of the product. However, some standard installation may be performed during the on-site repair, at VIZIO's option and sole discretion. Please read VIZIO's Limited Product Warranty for warranty terms and conditions.

Warranty Replacement Procedure

Warranty Replacement generally is performed on displays which are determined to be economically unrepairable.

If VIZIO Technical Support determines that a problem with a display unit may be within the terms and conditions of the VIZIO Limited Product Warranty and that a repair is not economically possible, based on certain manufacturing defects in materials and/or workmanship, and/or at VIZIO's option and sole discretion, the customer will be provided with a return authorization number and replacement instructions. Proof of purchase is required to confirm the product is within the one-year limited warranty period and meets the terms and conditions of the VIZIO Limited Product Warranty.

For displays forty-two inches (42") and larger, VIZIO will generally cover the transportation charges to perform an on-site swap of the original unit with the replacement unit. For displays under forty-two inches (42"), the customer is responsible for the transportation charges to VIZIO's service center. VIZIO will be responsible for the return transportation charges from the service center to the customer. Please read VIZIO's Limited Product Warranty for warranty terms and conditions.

Mail-In Warranty Repair Procedure

Mail-In Warranty Repair generally is performed on displays which are smaller than 30 inches.

If VIZIO Technical Support determines that a problem with a display unit may be within the terms and conditions of the VIZIO Limited Product Warranty and that a mail-in repair may be performed, the customer will be provided with a return authorization number and mail-in repair instructions. Proof of purchase is required to confirm the product is within the one-year limited warranty period and meets the terms and conditions of the VIZIO Limited Product Warranty.

The customer will be provided with instructions for packing and shipping the unit to the VIZIO service center. The original carton box and packing material, or an equivalent as designated by VIZIO, must be utilized. The cost of shipping to VIZIO's service center is at the customer's expense. After the product is repaired and tested, the VIZIO service center will ship the unit back to the customer at VIZIO's expense. VIZIO is not responsible for the de-installation or re-installation of the product. Please read VIZIO's Limited Product Warranty for warranty terms and conditions.

**PLEASE DO NOT RETURN YOUR UNIT TO VIZIO WITHOUT PRIOR
AUTHORIZATION.**



Index

Accessories.....	9	DTV Transition	5
Adjustments		DVD Player	
Closed Caption.....	14	Connecting	22
Selecting the Screen Size	14	DVI	
Advanced Adjustments	39	Cable Box	19
Antenna.....	17	DVD Player	22
Audio Menu		Satellite Box	19
Analog Audio Out adjustments.....	43	Fine Tuning the picture	36
Audio Mode adjustments.....	42	HDMI	17
Balance adjustments.....	42	Horizontal/Vertical Position adjustments	48
Digital Audio Out	42	INFO Button	38
Equalizer adjustments.....	42	Input Source	
Lip Sync adjustments.....	43	Choosing.....	35
Reset Audio Mode.....	43	Inputs	
Speaker adjustments	42	Antenna.....	4
SRS TruVolume	42	Connectors.....	17
SRS TSHD (surround sound) adjustments	42	Installation services.....	9
Audio Menu Adjustments	42	Maintenance of TV	54
Blocking Channels	48	Media Port.....	28
Brightness	40	Music Settings.....	31
Cable Box		Picture Settings.....	30
Connecting	18	Video Settings.....	32
Camcorder		Naming Inputs	47
Connecting.....	24	On Screen Display	39
CC Closed Caption	47	OSD	
CEC	46	Closed Caption Selection.....	14
CEC Function.....	46	Parental Controls	48
Device Discovery	46	Block Unrated Programming	50
CEC Function.....	46	Canadian English Rating.....	49
CEC Menu	46	Canadian French Rating	50
Changing Channels.....	38	Change the Password.....	50
Channel information	44	Channel Block.....	48
Cleaning your VIZIO TV	54	DTV Rating.....	50
Coaxial connection		Rating Enable.....	48
Satellite box.....	21	US Movie Rating	49
Coaxial Connection		US TV Rating	49
cable TV.....	21	Picture Menu	40
Color	40	Adaptive Luma	41
Component Connector	17	Advanced Video	41
Composite Connector	17	Backlight	40
Computer		Backlight Control	41
Connecting	26	Brightness	40
PC Resolutions	27	Color	40
Connecting Equipment		Color Enhancement	41
Cable.....	18	Color Temperature	41
Computer	26	Contrast	40
DVD	22	Film Mode	41
Rear Panel Connections	13	Noise Reduction.....	41
Satellite Box	18	Picture Mode	40
Sound system	25	Reset Picture Mode.....	41
Stereo	25	Sharpness.....	40
VCR	24	Smooth Motion.....	41
Video Camera	24	Tint	40
Contents.....	9	PIP	45
Contrast	40	Remote Control.....	14
Controls		Batteries.....	16
Front Panel.....	12	Component Codes	53
Side Panel.....	12	Programming the Universal Remote	52
Daylight Savings setting.....	44	Programming to work your DVD Player	53
Device Discovery	46	Programming to work your Set-Top Box	52



Programming to work your VCR.....	52	Stand Assembly	10
Range	16	Stereo	
Using your Cable or Satellite Remote to Operate your VIZIO TV	53	Connecting	25
Reset All Settings.....	50	S-Video	17
Resetting the System	50	Technical Support	57
RGB	17	Time Zone setting	44
Connecting your PC	26	Tint.....	40
Safety Instructions.....	2	Troubleshooting	55
Satellite Box		TV Menu	
Connecting	18	Auto Search adjustments	44
Screen Size explanation	51	Partial Channel Search	44
Search for channels	44	Skip Channel.....	44
Select Language (MTS)	44	Tuner Mode adjustments	44
Setting picture formats	51	TV Menu Adjustments.....	44
Setting up.....	11	VCR	
Setup Menu.....	45	Connecting	24
CC.....	47	Viewing Modes.....	51
Language setup	45	Volume	38
Parental Controls	48	Wall mounting	11
PIP	45	Warranty	81
Setup Wizard.....	50	Warranty services	9
System Menu	50	Watching TV	
Wide.....	46	Basic Adjustments.....	38
Sharpness	40	Basic connections	33
Skip Channel.....	44	First Startup.....	33
Sleep timer settings.....	46	Getting your Programs	37
Specifications		Program Information	38
Media Port.....	28	Wide.....	46
TV	59	Wizard.....	50

