



LCD FLAT PANEL HDTV

MODELS

LT-37131

LT-46131

OWNER'S GUIDE

- For questions:
 - Call Consumer Relations at 800-332-2119.
 - E-mail us at MDEAservice@mdea.com.
 - Visit our website at www.mitsubishi-tv.com.
- For information on **Demo Mode** and **System Reset**, please see the back cover.
- To order additional remote controls or Owner's Guides, call 800-553-7278.
- Guidelines for setting up and using your new widescreen TV start on page 13.





CAUTION

RISK OF ELECTRIC SHOCK
DO NOT OPEN



CAUTION: TO REDUCE THE RISK OF ELECTRIC SHOCK, DO NOT REMOVE COVER (OR BACK). NO USER SERVICEABLE PARTS INSIDE. REFER SERVICING TO QUALIFIED SERVICE PERSONNEL.



The lightning flash with arrowhead symbol within an equilateral triangle is intended to alert the user of the presence of uninsulated "dangerous voltage" within the product's enclosure that may be sufficient magnitude to constitute a risk of electric shock.



The exclamation point within an equilateral triangle is intended to alert the user to the presence of important operating and maintenance (servicing) instructions in the literature accompanying the appliance.

WARNING: TO REDUCE THE RISK OF FIRE OR ELECTRIC SHOCK, DO NOT EXPOSE THIS APPLIANCE TO RAIN OR MOISTURE.

FCC Declaration of Conformity

Product: LCD HDTV Display
Models: LT-37131, LT-46131
Responsible Party: Mitsubishi Digital Electronics America, Inc.
9351 Jeronimo Road
Irvine, CA 92618-1904
Telephone: 800-332-2119

This device complies with Part 15 of the FCC Rules. Operation is subject to the following two conditions:

- (1) This device may not cause harmful interference, and
- (2) this device must accept any interference received, including interference that may cause undesired operation.

Note: This equipment has been tested and found to comply with the limits for a Class B digital device, pursuant to part 15 of the FCC Rules. These limits are designed to provide reasonable protection against harmful interference in a residential installation. This equipment generates, uses and can radiate radio frequency energy and, if not installed and used in accordance with the instructions, may cause harmful interference to radio communications. However, there is no guarantee that interference will not occur in a particular installation. If this equipment does cause harmful interference to radio or television reception, which can be determined by turning the equipment off and on, the user is encouraged to try to correct the interference by one or more of the following measures:

- Reorient or relocate the receiving antenna.
- Increase the separation between the equipment and the receiver.
- Connect the equipment into an outlet on a circuit different from that to which the receiver is connected.
- Consult the dealer or an experienced radio/TV technician for help.

Changes or modifications not expressly approved by Mitsubishi could cause harmful interference and would void the user's authority to operate this equipment.

WARNING: This product contains chemicals known to the State of California to cause cancer and/or birth defects or other reproductive harm.

Our Thanks...

Thank you for choosing Mitsubishi as your premier Home Entertainment provider.

This Owner's Guide describes the features and functions of your Mitsubishi widescreen, high definition TV. We urge you to examine this Owner's Guide to become familiar with the innovative features and operations this unique television offers.

The very core of our corporate philosophy is to provide our customers with the very best. Our development team at Mitsubishi has worked to provide you with a television that defines "state-of-the-art," with the capability to meet your needs now and in the future.

Whether this is your first Mitsubishi electronic product, or an addition to your Mitsubishi collection, we believe you and your family will continue to enjoy your Mitsubishi home theater for many years.

Thank you,

Mitsubishi Digital Electronics America, Inc.

For Your Records

Record the model number, serial number, and purchase date of your TV. The model and serial numbers are on the back of the TV. Refer to this page when requesting assistance with this TV.

MODEL NUMBER (check one):

LT-37131

LT-46131

SERIAL NUMBER _____

PURCHASE DATE _____

Retailer Information

RETAILER NAME _____

LOCATION _____

Contents

Important Information About Your TV

General Warnings and Cautions, Notes on Installation and Operation	6
Cleaning Recommendations	7
Important Safeguards	8
Stand Removal Instructions	10

Chapter 1: Television Overview

Package Contents	12
Special Features of Your TV	12
Guidelines for Setting Up and Using Your New Widescreen TV	13
TV Front Panel, Power Button and Indicators	
Control Panel	15
System Reset Button	15
A/V Reset	15
Input 3 Jacks	15
TV Indicators	16
Manual and Power Swivel	16
CableCARD™ Technology	17
Back and Side Panels	18

Chapter 2: TV Connections

Before You Begin	
Choosing a Language for Menus	22
ClearThought® Easy Connect Auto Input Sensing	22
Digital Video and Home Recording	23
Connection Types	24
Cable Management	25
HDTV Cable Box or Satellite Receiver with Component Video	26
Standard Cable Box, Satellite Receiver, or Other Device with S-Video	26
Wall Outlet Cable (no cable box)	27
Antenna with a Single Lead	28
Antennas with Separate UHF and VHF Leads	28
VCR to an Antenna or Wall Outlet Cable	29
VCR to a Cable Box (Audio & Video)	30
HDMI Device (Cable Box, Satellite Receiver, DVD Player, or Other Device)	31
DVI Video Device (Cable Box, Satellite Receiver, DVD Player, or Other Device)	31
DVD Player with Component Video	32
A/V Receiver (Stereo System)	32
Older Cable Box	33
Camcorder	33

Chapter 3: TV Operation

Remote Control	36
Choosing a Program Source	38
ChannelView™ Channel Listings	38
Status Display	39
TV Signals and Display Formats	40

Split Screen	42
Chapter 4: TV Menu Settings	
3D Graphical ▶ViewPoint® Menu System	46
Main Menu	47
Setup Menu	48
Input Name Menu	50
Icon Order Menu	50
Channel Menu	51
Captions Menu	53
Parental Lock Menu	55
Setting a Pass Code	55
Lock TV by Time and Front-Panel Lock	55
Rating Menus	55
Bypassing the Ratings Lock and Lock by Time	57
V-Chip Signal Information	
TV Ratings	58
Movie Ratings	58
Audio/Video Menu	59
Audio Settings	60
Video Settings	61
Chapter 5: Operating Other Devices with the Remote Control	
Functions Available for Other A/V Devices	64
Programming the Remote Control	65
Programming Codes	66
Chapter 6: Using the TV with a Personal Computer	
Setup	76
Video Adjustments	76
Connecting a Computer to the TV	77
Adjusting Image Resolution	79
Computer Display Formats	80
Chapter 7: Using IEEE 1394 Devices	
Overview	82
Recording to IEEE 1394 Recordable Devices	84
The TV Remote Control and IEEE 1394 Devices	86
A/V Discs	87
Switching Between Analog and Digital IEEE 1394 Outputs	88
Appendices	
Appendix A: Bypassing the Parental Lock	91
Appendix B: Specifications	93
Appendix C: Troubleshooting	95
Trademark and License Information	102
Mitsubishi TV Software	103
Index	105

Important Information About Your TV

WARNING: This product contains chemicals known to the State of California to cause cancer and/or birth defects or other reproductive harm.

CAUTION: TO PREVENT ELECTRIC SHOCK, MATCH WIDE BLADE OF PLUG TO WIDE SLOT, FULLY INSERT.

TV WEIGHT: This TV is heavy! Exercise extreme care when lifting or moving it. Lift or move the TV with a minimum of two adults. To prevent damage to the TV, avoid jarring or moving it while it is turned on. Always power off your TV before moving it.

Stand Requirement

CAUTION: The attached TV stand needs to be used or other authorized optional mounting hardware.

For wall-mounting, the authorized hardware is:

Wall Mount Kit # PSM-2031 manufactured by Chief Manufacturing, Inc. See page 10 for more information.

Use with other than the authorized accessories may result in making the TV unstable which can cause damage to the product or possible injury.

Custom cabinet installation must allow for proper air circulation around the television.

NOTE TO CATV SYSTEM INSTALLER: THIS REMINDER IS PROVIDED TO CALL THE CATV SYSTEM INSTALLER'S ATTENTION TO ARTICLE 820-40 OF THE NEC THAT PROVIDES GUIDELINES FOR THE PROPER GROUNDING AND, IN PARTICULAR, SPECIFIES THAT THE CABLE GROUND SHALL BE CONNECTED TO THE GROUNDING SYSTEM OF THE BUILDING, AS CLOSE TO THE POINT OF CABLE ENTRY AS PRACTICAL.

Operating Notes

Demo Mode

This TV has a demo mode for use in retail stores. To turn off demo mode:

1. Press **MENU**.
2. When the Main menu appears with **Setup** highlighted, press **ENTER**.
3. When the Setup menu opens, press **▶** to highlight the on-screen **Demo Mode Off** button.
4. Press **ENTER**.

If Your TV Gets Damaged

Crystalline liquid may leak from the LCD panel and broken glass may be scattered.

CAUTION: The crystalline liquid is toxic. Avoid contact with your skin, eyes, or mouth.

- DO NOT touch the broken glass or crystalline liquid with bare hands, as cuts, poisoning, and/or skin irritation may occur.
- DO NOT let glass fragments or crystalline liquid get into your eyes or mouth.
- **Should either contact your eyes or mouth, rinse the contacted area thoroughly with water and consult your doctor.**

Disposal of Your TV

The LCD panel contains a small amount of crystalline liquid and the fluorescent tube in the panel contains mercury.

Both are toxic and should not be touched.

- DO NOT dispose of the TV with general household waste.
- Follow your local laws and regulations for legal and safe disposal of your TV.
- For disposal or recycling information, please contact your local authorities or the **Electronic Industries Alliance** at www.eiae.org.

Cleaning Recommendations

Normally, light dusting with a dry, non-scratching duster will keep your TV clean. If cleaning beyond this is needed, please use the following guidelines:

First, turn off the TV and unplug the power cord from the power outlet.

Top and Sides of the TV

- Gently wipe down your TV with a soft, non-abrasive cloth such as cotton flannel or a clean cloth diaper, lightly moistened with water. Dry with a second dry, soft, non-abrasive cloth.
- For oily dirt, add a few drops of mild liquid detergent, such as dishwashing detergent, to the water used to moisten the cloth. Rinse with a second cloth moistened only with water. Dry with a third dry, soft, non-abrasive cloth.

LCD Screen Cleaning

- **Only use a soft, dry cloth to clean the screen. Do not use any liquids.**
- Wipe the screen gently with an up and down motion.
- Clean the entire screen evenly, not just sections of the screen.

General Cleaning Warnings

- **DO NOT use any liquid to clean the screen. Only use a dry, soft cloth.**

For cleaning TV surfaces other than the screen:

- DO NOT allow liquid to enter the TV through the ventilation slots or any crevice.
- DO NOT use any strong or abrasive cleaners, as these can scratch the surfaces.
- DO NOT use any cleaners containing ammonia, bleach, alcohol, benzene, or thinner, as these can dull the surfaces.
- DO NOT spray liquids or cleaners directly on the TV's surfaces.
- DO NOT scrub or rub the TV harshly. **Wipe all surfaces gently.**

TV Software

Unauthorized Software

Do not attempt to update the software of this TV with software or cards that are not provided by or authorized by Mitsubishi Digital Electronics America, Inc. Non-authorized software may damage the TV and will not be covered by the warranty.

IMPORTANT

DO NOT apply any type of liquid to the surface of the TV screen.

Important Safeguards

Please read the following safeguards for your TV and retain for future reference. Always follow all warnings and instructions marked on the television.

1. Read, Retain and Follow All Instructions

Read all safety and operating instructions before operating the TV. Retain the safety and operating instructions for future reference. Follow all operating and use instructions.

2. Heed Warnings

Adhere to all warnings on the appliance and in the operating instructions.

3. Cleaning

Unplug the TV from the wall outlet before cleaning. Do not use liquid, abrasive or aerosol cleaners. Cleaners can permanently damage the cabinet and screen. Use a lightly dampened cloth for cleaning.

4. Attachments and Equipment

Never add any attachments and/or equipment without approval of the manufacturer as such additions may result in the risk of fire, electric shock or other personal injury.

5. Water and Moisture

Do not use the TV where contact with or immersion in water is possible. Do not use near bath tubs, wash bowls, kitchen sinks, laundry tubs, swimming pools, etc.

6. Accessories



Do not place the TV on an unstable cart, stand, tripod, or table. The TV may fall, causing serious injury to a child or adult and serious damage to the TV. Use only with a cart, stand, tripod, bracket or table recommended by the manufacturer, or sold with the TV. Any mounting of the TV should follow the manufacturer's instructions, and should use mounting accessories recommended by the manufacturer.

An appliance and cart combination should be moved with care. Quick stops, excessive force, and uneven surfaces may cause the appliance and cart combination to overturn.

7. Ventilation

Slots and openings in the cabinet are provided for ventilation and to ensure reliable operation of the TV and to protect it from overheating. Do not block these openings or allow them to be obstructed by placing the TV on a bed, sofa, rug, or other similar surface. Nor should it be placed over a radiator or heat register. If the TV is to be placed in a rack or bookcase, ensure that there is adequate ventilation and that the manufacturer's instructions have been adhered to.

8. Power Source

This TV should be operated only from the type of power source indicated on the marking label. If you are not sure of the type of power supplied to your home, consult your appliance dealer or local power company.

9. Grounding or Polarization

This TV is equipped with a polarized alternating current line plug having one blade wider than the other. This plug will fit into the power outlet only one way. If you are unable to insert the plug fully into the outlet, try reversing the plug. If the plug should still fail to fit, contact your electrician to replace your obsolete outlet. Do not defeat the safety purpose of the polarized plug.

10. Power-Cord Protection

Power-supply cords should be routed so that they are not likely to be walked on or pinched by items placed upon or against them, paying particular attention to cords at plugs, convenience receptacles, and the point where they exit from the TV.

11. Lightning

For added protection for this TV during a lightning storm, or when it is left unattended and unused for long period of time, unplug it from the wall outlet and disconnect the antenna or cable system. This will prevent damage to the TV due to lightning and power-line surges.

Important Safeguards, continued

12. Power Lines

An outside antenna system should not be located in the vicinity of overhead power lines or other electric light or power circuits, or where it can fall into such power lines or circuits. When installing an outside antenna system, extreme care should be taken to keep from touching such power lines or circuits as contact with them might be fatal.

13. Overloading

Do not overload wall outlets and extension cords as this can result in a risk of fire or electric shock.

14. Object and Liquid Entry

Never push objects of any kind into this TV through openings as they may touch dangerous voltage points or short-out parts that could result in fire or electric shock. Never spill liquid of any kind on or into the TV.

15. Outdoor Antenna Grounding

If an outside antenna or cable system is connected to the TV, be sure the antenna or cable system is grounded so as to provide some protection against voltage surges and built-up static charges.

Article 810 of the National Electric Code, ANSI/NFPA No. 70-2002, provides information with respect to proper grounding of the mast and supporting structure, grounding of the lead in wire to an antenna discharge unit, size of grounding conductors, location of antenna discharge unit, connection to grounding electrodes, and requirements for the grounding electrode.

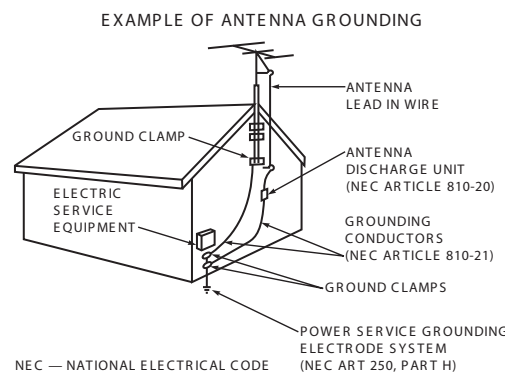

16. Servicing

Do not attempt to service this TV yourself as opening or removing covers may expose you to dangerous voltage or other hazards. Refer all servicing to qualified service personnel.

17. Damage Requiring Service

Unplug the TV from the wall outlet and refer servicing to qualified service personnel under the following conditions:

- (a) When the power-supply cord or plug is damaged.
- (b) If liquid has been spilled, or objects have fallen into the TV.
- (c) If the TV has been exposed to rain or water.
- (d) If the TV does not operate normally by following the operating instructions, adjust only those controls that are covered by the operating instructions as an improper adjustment of other controls may result in damage and will often require extensive work by a qualified technician to restore the TV to its normal operation.
- (e) If the TV has been dropped or the cabinet has been damaged.
- (f) When the TV exhibits a distinct change in performance - this indicates a need for service.

18. Replacement Parts

When replacement parts are required, be sure the service technician has used replacement parts specified by the manufacturer or have the same characteristics as the original part. Unauthorized substitutions may result in fire, electric shock or other hazards.

19. Safety Check

Upon completion of any service or repair to the TV, ask the service technician to perform safety checks to determine that the TV is in safe operating condition.

20. Heat

The product should be situated away from heat sources such as radiators, heat registers, stoves or other products (including amplifiers) that produce heat.

Stand Removal Instructions

CAUTION

- A minimum of TWO PEOPLE are needed to safely remove the stand.
- One person needs to hold the TV, while the other person removes the stand.
- Failure to follow these recommendations may result in personal injury as well as damage to the product.

1. Before starting to remove the stand, make sure to disconnect the AC power cord from the AC power outlet.
2. Spread the protective sheet that was wrapped around the TV on a **flat, even surface** (such as a sturdy table). The protective sheet will help prevent the display from being damaged.

IMPORTANT: To avoid damaging the screen, make sure there are no foreign objects under or on top of the protective sheet.

3. With two people firmly grasping the left and right sides of the TV, gently place the TV face down on the protective sheet with the display stand hanging over the edge of the table. See the illustration to the right.

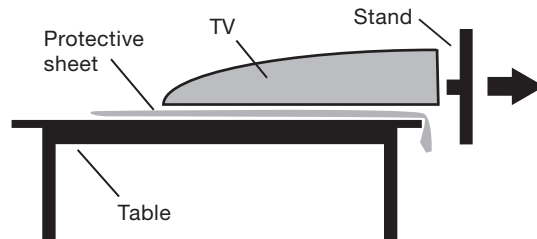

4. **LT-37131 model:** Disconnect the Power Swivel Cable from the TV only.

LT-46131 model: Skip Step 4. This model does not include the Power Swivel feature.

Both TV models can be swiveled manually thirty degrees left and right.

5. Use a Philips screwdriver to remove the four (4) stand screws. See the illustration to the right.
6. While one person holds on to the TV with both hands, the other person grasps the **plastic portion of the stand** (see illustration to the right) and removes the stand by pulling it away from the TV in the direction of the large arrow shown in both illustrations.

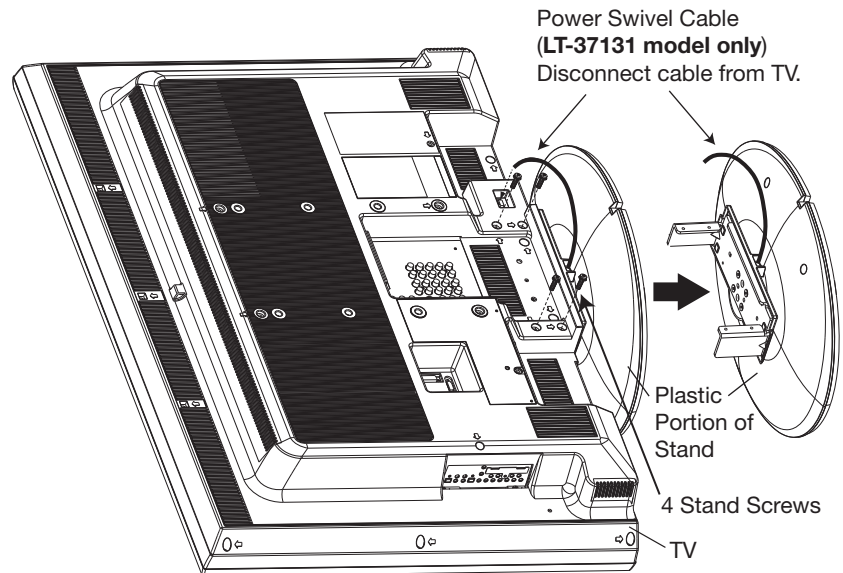

Place the stand and screws in a safe place for future use.

7. The TV is now ready for mounting. Refer to the instructions provided with the Wall Mount Kit (purchased separately).

Wall Mount Kit

To order a Wall Mount Kit (Part # PSM-2031):

Please call the Mitsubishi Parts Department at (800) 553-7278, or call Chief Manufacturing, Inc. at (800) 582-6480.

Note: Complete wall-mounting instructions are included with the wall mount kit.

IMPORTANT

Before attaching the wall mount kit to the TV, be sure to connect all necessary cables to jacks on the back of the TV. After wall-mounting, these jacks will not be accessible.

If you plan to connect a PC to the TV, before wall-mounting be sure to connect a DVI cable (or a DVI/VGA adapter cable) to the PC-DVI video input on the back of the TV. For PC audio, connect an RCA cable to the PC-DVI right/left audio inputs.



Television Overview

Package Contents	12
Special Features of Your TV	12
Guidelines for Setting Up and Using Your New Widescreen TV . . .	13
TV Front Panel, Power Button and Indicators	
Control Panel	15
TV Indicators	16
Manual and Power Swivel	16
CableCARD™ Technology	17
Back and Side Panels	18

Package Contents

Please take a moment to review the following list of items to ensure that you have received everything.

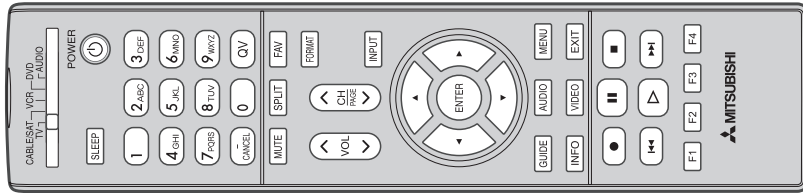

1. Remote Control
2. Two AA Batteries



3. Cable Tie (see *Cable Management*, in Chapter 2)
4. Product registration card (not pictured)
5. Owner's Guide (not pictured)
6. Quick Reference Guide (not pictured)

Special Features of Your TV

Your new high-definition widescreen 1080p LCD television has many special features that make it the perfect center of your home entertainment system, including:

16:9 Widescreen Picture Format

Enjoy a full theatrical experience in the comfort of your home. View pictures as film directors intended them. Digital TV broadcasts, DVDs and newer video game consoles support this widescreen format.

Integrated HDTV Tuner

Your widescreen Mitsubishi HDTV has an internal HDTV tuner able to receive both over-the-air HDTV broadcasts (received via an antenna) and non-scrambled digital cable broadcasts, including non-scrambled HDTV cable programming.

High-Definition Video Inputs

- ◆ **Two Component Video Inputs**, also called Y/Pb/Pr inputs. These inputs receive standard analog video formats of 480i, 480p, 720p and 1080i high-definition signals. This provides a high level of flexibility when connecting DVD players/recorders, cable boxes, and satellite receivers.
- ◆ **Two HDMI Inputs** that accept digital 480i, 480p, 720p, 1080 and 1080p video signals plus PCM digital stereo signals. Used with an adapter, these inputs also accept compatible DVI video signals. HDMI inputs provide additional high-performance, high-definition connections for maximum flexibility in your choice of home theater products. The HDMI inputs are HDCP copy-protection compatible.
- ◆ **Two IEEE 1394 Digital Interfaces** that receive and send compressed digital signals, including high-definition signals, along with digital audio and control signals between devices such as the TV, digital cable boxes, and D-VHS digital video recorders.

ClearThought® Easy Connect Auto Input Sensing

ClearThought® automatically recognizes when you plug in an input and prompts you to assign a name to it. The TV ignores any unused inputs, so the result is an uncluttered Input Selection menu where you can easily find and select connected devices by name.

Full Spectrum Color™

(LT-46131 Model only)

Mitsubishi's Full Spectrum Color™ results in 25% more color than standard LCD. Reds and yellows become more vivid and there are more available shades of Green, Cyan and Blue. The result is a more vivid and more realistic image.

Manual and Power Swivel

Both TV models (LT-37131 and LT-46131) allow you to swivel the TV manually up to 30 degrees from left to right. In addition, the LT-37131 model has the Power Swivel feature, which automatically swivels the TV left or right when you press ◀ or ▶ on the remote control. **Note:** Power Swivel is not available while the TV is in Split Screen mode.

PC Connectivity

The display has a PC (DVI) video connector that supports VGA, SVGA, XGA, or SXGA signals. Please see Appendix B for signal compatibility. Stereo audio inputs are also provided.

Digital Cable Ready (CableCARD™)

Your widescreen Mitsubishi HDTV is “Plug-and-Play” digital cable ready. It can descramble a cable provider’s one-way digital signals with the use of a CableCARD security module. The CableCARD is used in place of a traditional cable box to access digital cable programming (including high definition). Contact your local cable provider for availability information and service details.

Guidelines for Setting Up and Using Your New Widescreen TV

Getting Started

1. Read the section entitled “**Important Information About Your TV**” starting on page 5.
2. Choose a location for your TV.
 - Allow at least four inches of space on all sides of the TV help prevent overheating.
 - Avoid locations where light may reflect off the screen.
 - See the stand requirements under “**Important Information About Your TV.**”
3. Install the batteries in the remote control. See **chapter 3, “TV Operation,”** for information on use and care of the remote control.
4. Plug your TV into a power outlet. The **POWER** indicator on the front of the TV will start blinking rapidly. After the **POWER** indicator stops blinking, press the **POWER** key to power on the TV.
5. When the Welcome screen appears the first time you power on the TV, select a language for TV menus. You can later change the language through the **Setup menu**.
6. Some TVs are shipped from the factory with demo mode active for use in retail stores. If demo mode is active when you first turn on the TV:
 - a. Press **MENU**.
 - b. When the Main menu appears with **Setup** highlighted, press **ENTER**.
 - c. When the Setup menu opens, press **▶** to highlight the on-screen **Demo Mode Off** button.
 - d. Press **ENTER**.
7. Connect your other A/V devices to the TV and assign device names to the TV inputs when prompted. See **chapter 2, “TV Connections,”** for connection diagrams. You can reassign device names later if needed. See “**Input Name Menu**” in **chapter 4, “TV Menu Settings.”**

8. **Memorize channels** if you plan to watch over-the-air channels or programming over direct cable. Channel memorization may take up to 15 minutes to complete. See “**Setup Menu**” in **chapter 4, “TV Menu Settings.”**
9. You can now start watching TV or you can perform additional setup and customization through the TV menus.

Additional TV Setup

1. To program the remote control to operate your other A/V devices, see **chapter 5, “Operating Other Devices with the Remote Control.”**
2. Review **chapter 4, “TV Menu Settings,”** to customize TV operation. Press the **MENU** key to enter the menu system. Some examples of settings you may wish to change include:
 - **Energy Mode.** For faster power-on, keep the Energy Mode set to **Fast Power On**. For lower power consumption while the TV is off, use the **Low Power** setting. See “**Setup Menu.**”
 - **Input Name.** Change the device names that appear in the Input Selection menu. See “**Input Name Menu.**”
 - **Icon Order.** Rearrange the device icons in the Input Selection menu to put frequently used icons near the front. See “**Icon Order Menu.**”
 - **FAV.** Create lists of your favorite channels so you can find them quickly. See “**Channel Menu.**”
 - **Clock.** If you wish to schedule future recordings or use the Timer feature to have the TV come on automatically, you must first set the TV clock to the correct time. See “**Setup Menu.**”
 - **Parental Lock.** You can restrict TV viewing by program rating or by time of day. You can also disable the front-panel buttons—useful if you have small children. See “**Parental Lock Menu.**”
 - **Video Settings.** Change the video adjustments to get the best picture for your viewing conditions. See “**Audio/Video Menu.**”

Guidelines for Setting Up and Using Your New Widescreen TV, continued

You may wish to change the Picture Mode from the default **Brilliant** to either **Bright** or **Natural**, which are suitable for most home viewing environments.

3. If you have IEEE 1394 A/V devices, see **chapter 7, “Using IEEE 1394 Devices,”** for details on operating such devices and using the TV to control recording.

TV Operation

Review **chapter 3, “TV Operation,”** for TV features including:

- **Input Selection (viewing source).** Select a connected program source to watch, such as a VCR, DVD player, or antenna. Press **INPUT** on the remote control to select from icons for the TV inputs. See **“Input Selection Menu.”**
- **Channel Listings.** Press **GUIDE** to view ChannelView™ channel listings. See **“ChannelView™ Channel Guide.”**

- **Picture Formats.** Press **FORMAT** to cycle through the available picture sizes and shapes to find the one best suited to the program you’re watching. See **“TV Signals and Display Formats.”**
- **SPLIT.** Press **SPLIT** to view two programs at the same time. See **“Split Screen Mode.”**

Assistance

If you need assistance with this TV:

- For troubleshooting, service, and product support, see **Appendix D.**
- For warranty information, see the TV warranty in the back of this book.

TV Tips

Turning the TV On or Off

To turn the TV on or off, point the remote control at the front of the TV and press the **POWER** button. Alternatively, press the **POWER** button on the front panel of the TV.

Controlling Sound Volume

Press **VOL** \wedge/\vee to adjust the sound level.

Changing Channels

To change channels:

- Enter the channel number using the number keys on the remote control and press **ENTER**. For a two-part digital channel, such as 3-1, press **3** **-/CANCEL** **1** to enter a dash (separator).

- Press **CH** \wedge/\vee to change channels one channel at a time.
- Press and hold **CH** \wedge/\vee to move quickly through channels.
- Press **QV** (QuickView) to switch back to the previously tuned channel.
- Use the **FAV** (Favorites) feature to set up lists of favorite channels and tune to them with the **FAV** key. See **“Channel Menu”** in chapter 4.

NOTE: Memorize channels to make finding channels easier. See **“Setup Menu”** in chapter 4, **“TV Menu Settings.”**

TV Front Panel, Power Button and Indicators

Front Control Panel

To access the front control panel, gently press on the panel door located below the *Mitsubishi* logo on the front of the TV. The shaded buttons on the front control panel and the power button duplicate keys on the remote control.

See “Remote Control Overview” in chapter 3, “TV Operation,” for further details on the functions of these buttons.

These numbered items refer to the illustration on the right:

- ① Front Control Panel buttons (except for SYSTEM RESET) duplicate keys on the remote control.
- ② The **POWER** button duplicates the **POWER** key on the remote control. It is located underneath the front of the TV below the “POWER” label.
- ③ **POWER/TIMER** indicator (lit during normal operation; flashing when auto-on TV Timer is set)
- ④ **STATUS** indicator (off during normal TV operation)
- ⑤ **SYSTEM RESET** (see description on this page)
- ⑥ **REMOTE CONTROL SENSOR**
- ⑦ **INPUT 3 JACKS**

System Reset Button

If the TV does not respond to the remote control, front panel controls, or will not power on/off, press the **SYSTEM RESET** button on the front panel with a pointed object, such as the point of a pencil or end tip of a paperclip. The green LED will flash quickly for about one minute. When the green LED stops flashing, you may turn on the TV. The changes you made most recently, before using **SYSTEM RESET**, may be lost. Changes you made previously, however, are not lost.

A/V Reset

If you wish to reset the A/V (Audio/Video) settings back to the factory defaults:

- To reset all settings at once, press **GUIDE** and **FORMAT** on the front panel at the same time.
- To reset the defaults for individual devices, use the **A/V Memory Reset** selection on the Audio/Video menu.

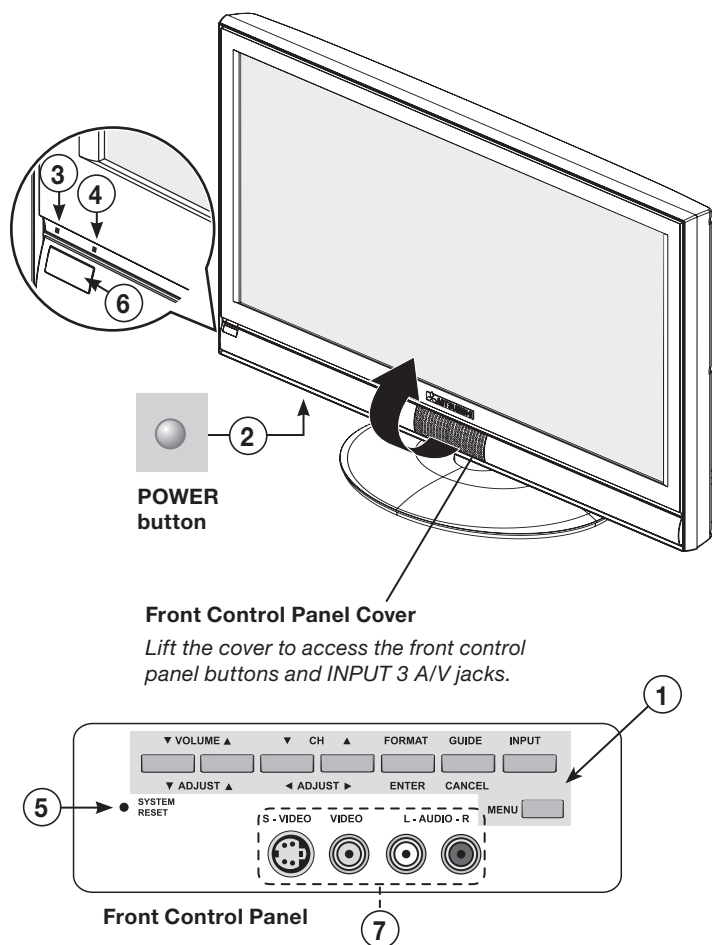

Input 3 A/V Jacks

INPUT 3 provides an easily accessible set of standard audio/video jacks. These jacks allow for convenient connection of a camcorder or other audio/video device. Note that if you connect to the **S-VIDEO** jack, the **VIDEO** jack is deactivated.

TV Indicators

○ Off ● Steady On ◐ Slow Blinking ◎ Fast Blinking

POWER/TIMER Indicator

LED Color	TV Condition	Additional Information
None ○	TV is powered off.	Normal operation.
Blue ●	TV is powered on.	Normal operation.
Blue ◎	1. TV just plugged into AC outlet.	Wait until blinking stops before turning on (approximately 1 minute). Normal operation.
	2. AC just restored after power failure.	
	3. TV Rebooting after System Reset used.	
	4. TV Rebooting after power fluctuation or receiving abnormal digital signals from digital channel, CableCARD™, or digital device.	
	5. You have begun the procedure to update software from an authorized flash memory device.	For detailed information, see the instructions that accompany the authorized software update. Important: Do not use unauthorized software at any time.
Blue ◐	TV powered off and auto-on timer is set.	Normal operation. TV can be turned on at any time.

STATUS Indicator

LED Color	TV Condition	Additional Information
None ○	Normal TV on or standby condition.	Normal operation.
Red ●	TV may require service.	Turn off the TV and unplug the set from the AC power source. Wait one minute and then plug the set back in.
		If the LED is still on, contact your dealer or a Mitsubishi Authorized Service Center. See www.mitsubishi-tv.com or call 1-800-332-2119 to receive Authorized Service Center information.

CableCARD™ Technology

CableCARD is a nationwide system standard that allows your local cable TV provider to supply you with an access card customized to your account. This card allows your TV to receive, decode, and unscramble the premium digital channels included in your cable TV subscription without the use of a cable box. When you move to a new cable provider's area, return the CableCARD to the original cable provider and get a new card from your new provider.

Please note that CableCARD is a relatively new technology and your local cable provider may not currently be offering this service. As time passes, this system will become broadly supported by most cable providers.

The CableCARD system is unidirectional, meaning your cable provider can send updates to the TV, but the TV cannot send signals back. As a result, certain advanced and interactive digital cable services, such as requests for video-on-demand and pay-per-view programs, a cable operator's enhanced program guide, and data-enhanced television services may require use of a set-top box instead. For more information, call your local cable operator.

Digital cable channels authorized by the CableCARD are available on the Firewire® IEEE 1394 network and can be shared by other products on the network. You may be unable to record or copy some digital programs, however, because of copy restrictions set by the content or copy-right owners.

Using a CableCARD™

Power on the TV and insert the CableCARD into the CableCARD slot with the top of the card oriented as indicated by **CARD TOP ▲**. When the initial screen displays, write down the information that appears and have it ready when calling your cable provider.

In order to start cable service for this device, please contact your cable provider
 1-800-xxx-xxxx
 CableCARD(tm): xxx-xxx-xxx-xxx-xxx-x
 Host: xxx-xxx-xxx-xxx-x
 Data: xxx-xxx-xxx-xx
 UnitAddress: xx-xxxxx-xxxxx-xxx
 Press EXIT to exit.

Sample CableCARD initial screen. Record the information before contacting your cable provider.

To review the information later, press **MENU** and when the Main menu appears, press **9 9 9** to re-display the screen.

Note: CableCARD™ requires the TV's **Fast Power On** setting. If you insert a CableCARD™, the TV will automatically override a **Low Power** setting and change to the **Fast Power On** setting.

CableCARD™ Menu

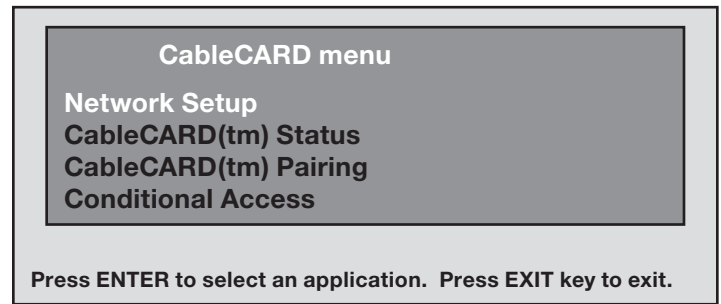

Sample CableCARD menu

To display the CableCARD menu with links to applications from your cable provider:

1. While watching CableCARD, press **INPUT** to open the Input Selection menu.
2. With the CableCARD icon highlighted, press **MENU** to open the CableCARD menu.
3. Press **▲ ▼** to highlight a link (blue text), then press **ENTER** to access the linked page.
4. To redisplay the CableCARD menu, repeat steps 1 and 2.
5. Press **EXIT** to return to TV viewing.

If there are technical problems with the CableCARD, an error screen automatically displays with information that may be needed by your cable provider when you call them for assistance.

Moving Through Other CableCARD Screens

In addition to CableCARD menus, other CableCARD application screens may display and require you to make additional selections. When using these screens on your Mitsubishi television:

- Blue text denotes a link to another screen. Press **ENTER** to move to the next application. Screens without blue text contain no links.
- You cannot move backward through the links. To exit the CableCARD system, press **EXIT**. The **CANCEL** key may not work with some CableCARD screens.

All information on these application screens is provided by your local cable company. Contact your cable provider if you have any problems with the application screen displays.

IMPORTANT

Most CableCARD screens show only status or diagnostic information and do not allow you to make changes. These screens are meaningful only to your local cable provider.

IMPORTANT

To use a CableCARD, connect the primary incoming cable to ANT 1/MAIN on the TV.

Back and Side Panels

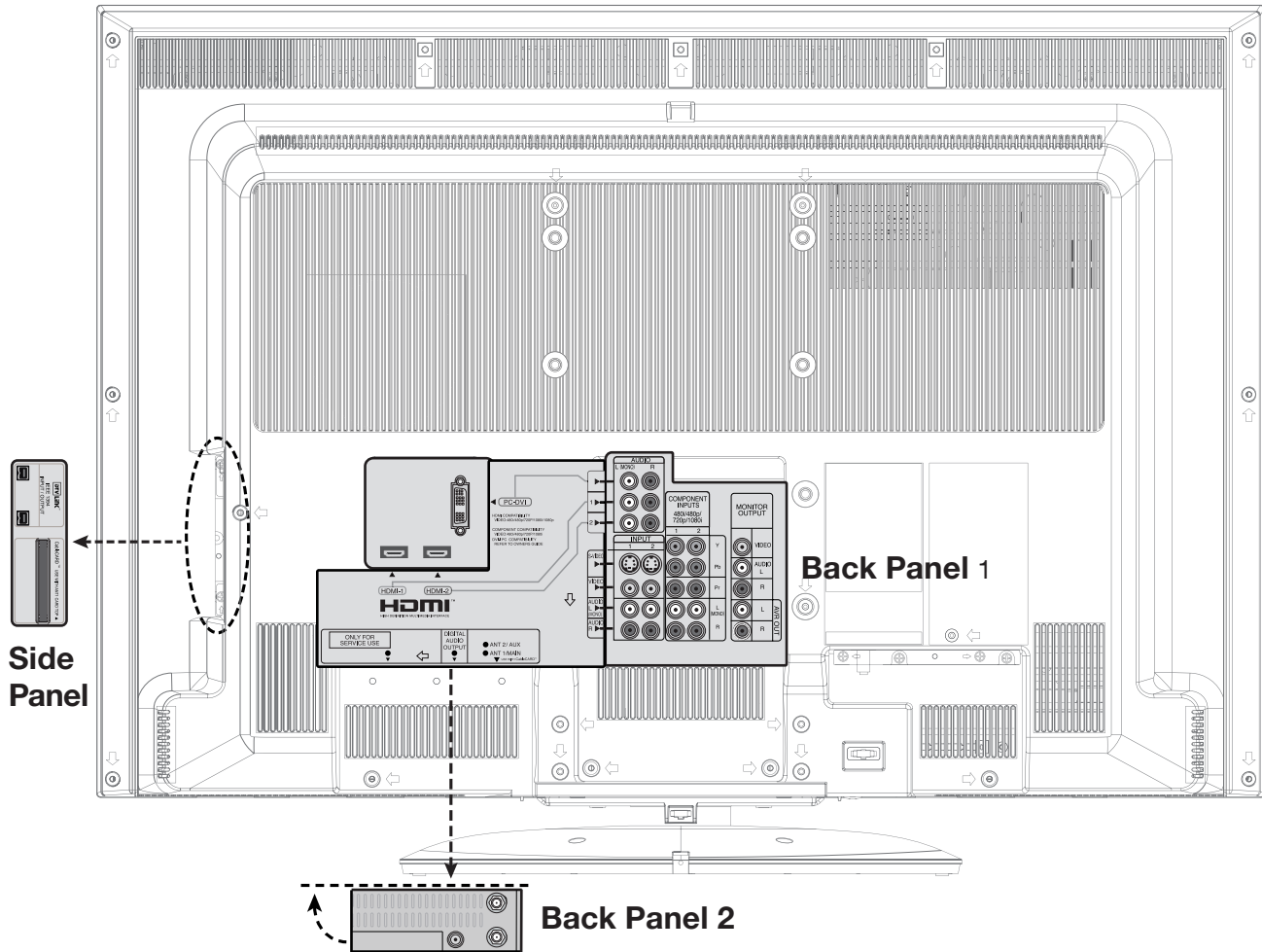

1. ANT 1/MAIN, ANT 2/AUX (Antenna)

If you are connecting an antenna, direct cable without a cable box, or are using cable with a CableCARD™, connect the main antenna or cable source to **ANT 1/MAIN**.

ANT 1/MAIN and **ANT 2/AUX** can each receive both digital and analog over-the-air channels from a VHF/UHF antenna or non-scrambled digital/analog cable source.

ANT 1/MAIN and CableCARD™

Use **ANT 1/MAIN** to receive premium subscription cable TV service authorized by the CableCARD™ access card. The CableCARD access card is provided by your local cable company. **ANT 2/AUX** can continue to receive over-the-air or non-scrambled cable signals when **ANT 1** is used for CableCARD™ service.

2. INPUT 1 and 2 Inputs

(Audio and Video)

INPUT 1 and **2** can be used to connect a VCR, Super VHS (S-VHS) VCR, DVD player, standard satellite receiver, or other A/V device to the TV. **INPUT 3** is a third set of jacks located in the front of the TV for convenience. Please note that if **S-VIDEO** and **VIDEO** are both available, you must choose to connect only one.

3. COMPONENT 1 and 2 Inputs

(Audio and Video)

Y Pb Pr (480i/480p/720p/1080i)

Use these jacks to connect devices with component video outputs, such as DVD players, external HDTV receivers, or compatible video game systems. Please see Appendix B for signal compatibility.

Back and Side Panels, continued

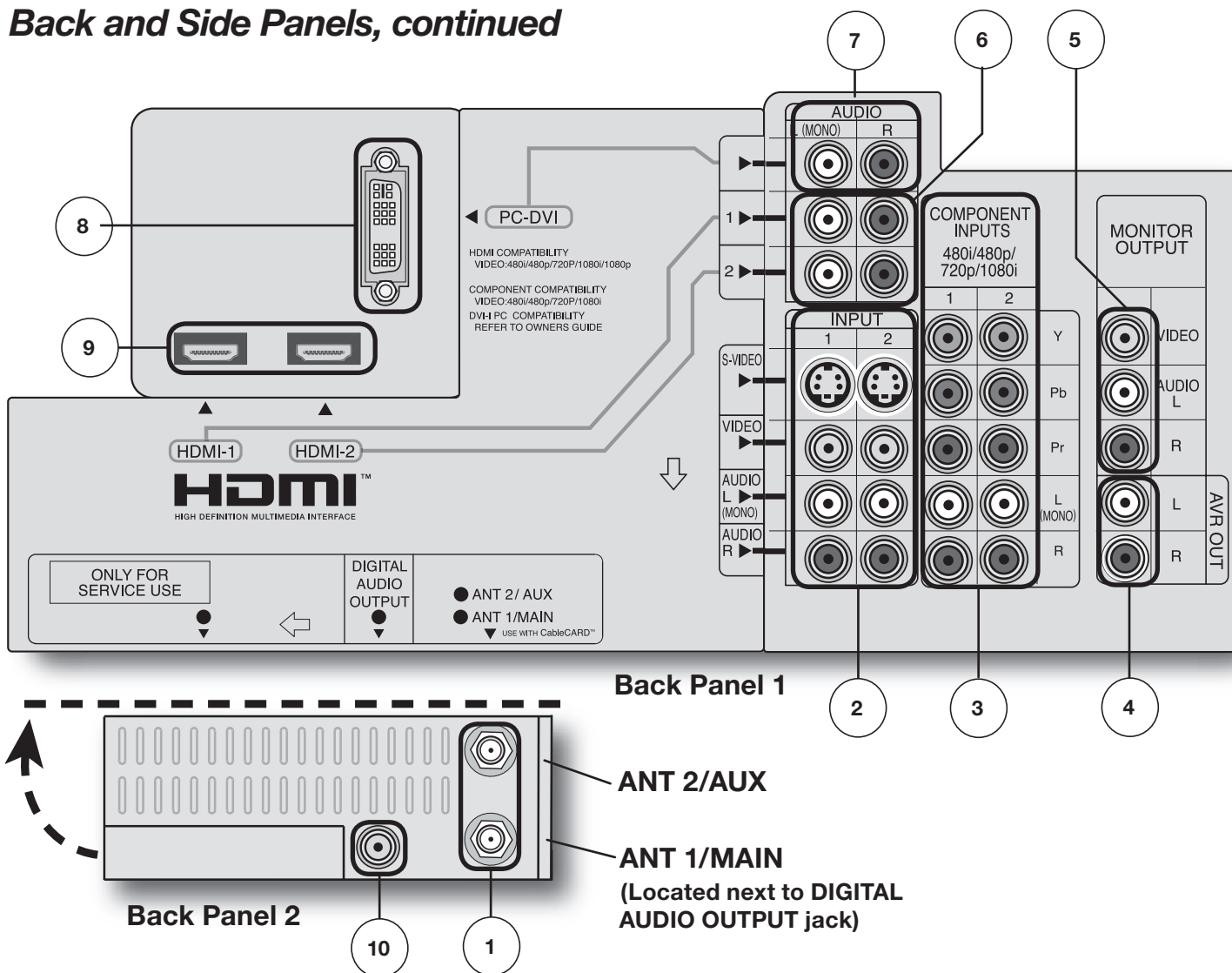

4. AVR OUT

(Audio only)

AVR OUT (AUDIO/VIDEO RECEIVER OUT) L/R jacks send analog audio of the program currently shown on the screen to an A/V surround sound receiver or stereo system. Digital audio from digital channels, FireWire® (DTVLink/IEEE 1394) devices and HDMI devices is converted to analog audio by the TV. If using an analog A/V receiver or stereo system, this is the only audio connection needed between it and the TV.

5. MONITOR OUTPUT

Use these composite video and left/right audio jacks to send analog video and audio signals to an external recording device such as a VCR. The signals from these jacks are from the program currently being viewed on the TV screen. **To make recordings from this output, the TV must be in normal full-screen mode rather than in Split-Screen mode.**

- From this output you can record audio and video signals from **ANT 1**, **ANT 2**, **INPUT 1-3**, and IEEE 1394 devices.
- Digital signals from **ANT 1**, **ANT 2**, and IEEE 1394 devices are converted to analog video and audio signals.
- Some signals cannot be recorded because of copy-protection flags in the content.
- Video signals from devices connected to **COMPONENT 1 & 2**, **HDMI 1 & 2** or **PC DVI** are not available from these **MONITOR OUTPUT** jacks.

6. HDMI/DVI AUDIO

Audio for HDMI 1 & 2: Use these analog audio inputs when connecting DVI devices to the TV's **HDMI** jacks. Unlike HDMI, DVI does not carry audio information on the same cable. **For analog audio from a personal computer, use the PC-DVI AUDIO jacks instead.**

Back and Side Panels, continued

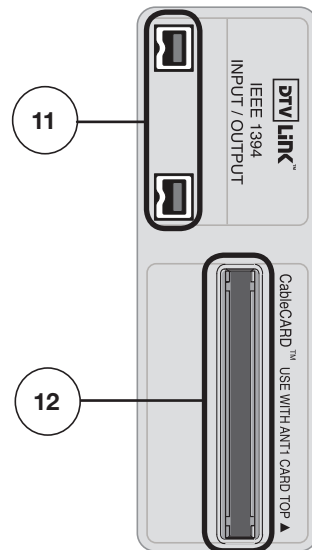

Side Panel

7. PC-DVI AUDIO

Use the **PC-DVI AUDIO** jacks in conjunction with the **PC-DVI** video input from a personal computer. These jacks allow you to send left and right analog audio from your computer to the TV.

8. PC-DVI

PC-DVI is a DVI-I input compatible with both DVI-A (analog) and DVI-D (digital) inputs. Connect your personal computer's HDMI, DVI, or VGA video output to this jack. An adapter or converter cable may be required. Please see Appendix B for signal compatibility. To hear audio from the computer, connect analog audio cables from the computer to the **PC-DVI AUDIO** jacks.

The PC-DVI input is not intended for standard video from cable boxes, satellite receivers, or DVD players.

9. HDMI™ 1 and 2

The HDMI (High Definition Multimedia Interface) supports uncompressed standard and high-definition digital video formats and PCM digital audio format. For PC video, use the **PC-DVI** input instead.

Do not connect a computer to either TV HDMI jack.

Use these inputs to connect to EIA/CEA-861 compliant devices such as a high-definition receiver or DVD player. These inputs support 480i, 480p, 720p, 1080i, and 1080p video formats.

These inputs can also accept DVI video inputs. To connect a DVI input, use an HDMI-to-DVI adapter or cable plus analog audio cables. Connect the analog audio cables to the **HDMI/DVI AUDIO** inputs on the TV to receive left and right stereo audio from your DVI device.

These inputs are HDCP (High-Bandwidth Digital Copy Protection) compliant.

These inputs are **SimplayHD™** certified for proper interoperability with other products certified by Simplay™.

10. DIGITAL AUDIO OUT

This output sends Dolby Digital or PCM digital audio to your digital A/V surround sound receiver. Analog audio from analog channels and devices is converted by the TV to PCM digital audio. If you have a digital A/V receiver, in most cases this is the only audio connection needed between the TV and your A/V receiver.

11. DTVLINK™/IEEE 1394

These jacks allow the TV to connect to external IEEE 1394 digital products by means of a single cable. See chapter 7, "Using IEEE 1394 Devices" for detailed information regarding IEEE 1394 connections and recording.

12. CableCARD™ Slot

The CableCARD access card from your cable TV service provider is inserted into this slot. When inserting, ensure that the top of the card faces in the direction indicated by **CARD TOP ▲**.

If your cable company is not currently offering CableCARD access cards, use the cable box provided and authorized by your local cable company to view scrambled channels.

TV Connections

Before You Begin

Choosing a Language for Menus.	22
ClearThought® Easy Connect Auto Input Sensing	22
Digital Video and Home Recording	23
Connection Types.	24
Cable Management.	25
HDTV Cable Box or Satellite Receiver with Component Video	26
Standard Cable Box, Satellite Receiver, or Other Device	
with S-Video	26
Wall Outlet Cable (no cable box).	27
Antenna with a Single Lead	28
Antennas with Separate UHF and VHF Leads.	28
VCR to an Antenna or Wall Outlet Cable	29
VCR to a Cable Box (Audio & Video)	30
HDMI Device (Cable Box, Satellite Receiver, DVD Player,	
or Other Device)	31
DVI Video Device (Cable Box, Satellite Receiver, DVD Player,	
or Other Device)	31
DVD Player with Component Video	32
A/V Receiver (Stereo System)	32
Older Cable Box	33
Camcorder.	33

Before You Begin

Choosing a Language for Menus

When you power on the TV for the first time, you can select either English or Spanish for all menus. You can later change the language through the Setup menu.

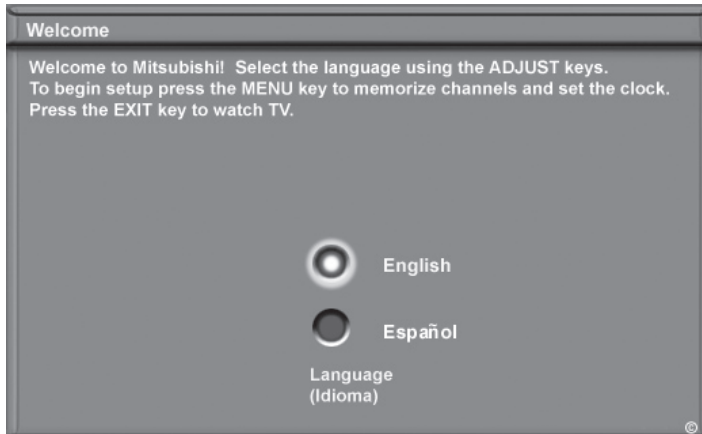

Figure 1. The Welcome screen lets you change the menu language when you first power on the TV.

ClearThought® Easy Connect Auto Input Sensing

This TV's ClearThought® auto input sensing feature allows it to detect most connections automatically. The first time you connect each device you will be prompted to identify it by selecting from a pre-set list of device names. The table below defines how connections on each TV jack are handled.

Auto Detection Active	No Auto Detection
INPUT 1, 2, 3 video jacks	ANT 1/ANT 2
COMPONENT video jacks	MONITOR OUTPUT (all jacks)
HDMI*	
PC-DVI*	
IEEE 1394	All AUDIO jacks

* If the device is powered off when connected, detection occurs when the device is next powered on.

1. Connect your devices to the TV, making note of which TV input you have used for each device.
The TV and the devices can be either on or off when connecting. If the TV is powered off, the detection process will occur the next time you turn on the TV.
2. For most devices, the Auto Input Sensing screen opens (see figure 2). With the text box highlighted, press ▲▼ to select a name for the device from the following list of names:

Cablebox
Camcorder
DVD
DVD2
DVR (digital video recorder, recordable DVD)
Game
HD Disc (high-definition disc)
Satellite
VCR

The name you assign here will appear in the Input Selection menu and can be changed later through the Input Name menu.

3. Press **EXIT** to close the screen. If you connected several devices at the same time, the screen for the next connection will open.

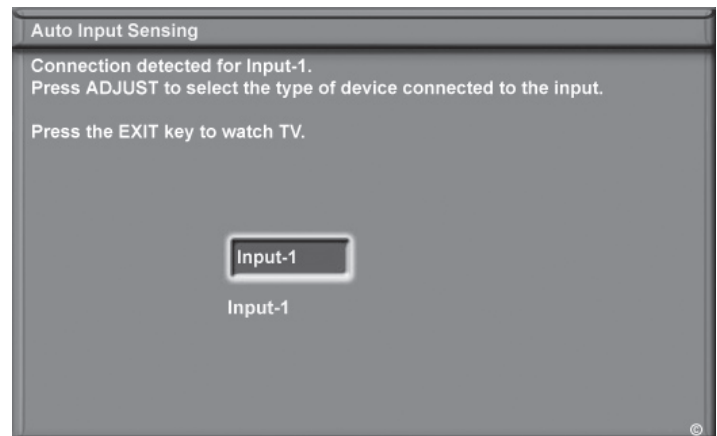

Figure 2. The Auto Input Sensing screen appears when a device is first detected. Select a name for the connected device in this screen.

More About Auto Input Sensing

- You can change the input name at a later time using the Input Name menu.
- If you disconnect a device and then later connect a different device to the unused jack, open the Input Name menu to update the device name.
- Antenna inputs (**ANT 1/ANT 2**) and TV outputs are never auto-detected.
- Be careful to choose different names for each input.

IEEE 1394 Connections

The screen in figure 3 appears when you make an IEEE 1394 connection,

IEEE 1394 Device with an Analog Connection.

Some IEEE 1394 devices have both digital and analog outputs to the TV. If you have such a device, place a check mark in the **Analog Connection** check box to:

- Allow a cable box with both analog and digital outputs to switch automatically between them.

Before You Begin, continued

- Allow you to use a TV menu to select either the analog or digital output from the device.

For instructions on switching between analog and digital outputs, see chapter 7, “Using IEEE 1394 Devices.”

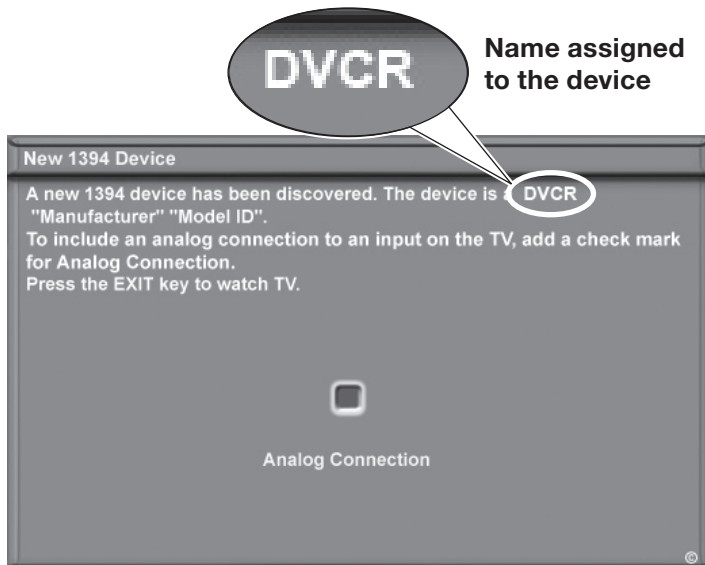

Figure 3. The ClearThought Auto Input Sensing screen for IEEE 1394 devices includes a check box for an associated analog connection.

If your IEEE 1394 device has an analog connection to the TV, follow the instructions below.

1. Connect the device to the TV with an IEEE 1394 cable first.
2. When the New 1394 Device screen appears with the Analog Connection check box highlighted, press **ENTER** to enter a check mark. See figure 3, New 1394 Device screen.

Note: It is important to check mark the box when this screen appears upon first connecting the device, as later changes can only be made after returning all TV settings to their defaults.

3. In the New 1394 Device screen, note the name assigned to the device, as you will need to use the same name in a later step. See figure 3.
 4. Connect the device to the TV with the supplemental analog cables.
 5. The next screen is the Auto Input Sensing screen (see figure 2) in which you can select a name for the device. Select the same name you noted in the New 1394 Device screen (see figure 3).
- If you select the wrong name for the device, you will be unable to switch between the analog and digital inputs to the TV.
 - If you connect an IEEE 1394 cable box and it is detected as CABLE in the New 1394 Device screen, be sure to select the name CABLE as the name for the analog input and not cablebox.

To Add an Analog Connection at a Later Time (not recommended)

1. Disconnect the IEEE 1394 device from the TV.
2. Reset all TV settings to their defaults using the TV Reset service menu as follows:
 - a. Press **MENU** to display the Main menu.
 - b. Press **1 2 3** to open the Reset service menu.
 - c. Press **ENTER**.
3. Reconnect the IEEE 1394 device to the TV.
4. When the TV recognizes the device, place a check in the **Analog Connection** check box.
5. Press **EXIT**.

Digital Video and Home Recording

The table below will help you decide which type of connection to use for digital video. Digital video comes to your home in a compressed state, whether received on recorded media (e.g., disc) or broadcast over the air, over cable, or via satellite. Some compressed digital video is available for recording as noted in the table.











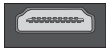

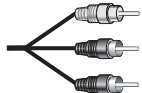
Connection Type into the TV	Effect on Home Recording
HDMI or DVI Compressed video is converted to uncompressed form by an external device such as a cable box, satellite receiver, or DVD player before it is sent to the TV on an HDMI or DVI cable.	You cannot record the resultant uncompressed video sent to the TV via HDMI or DVI.
IEEE 1394 (FireWire®) Connections Your TV can receive and decode digital channels, MPEG2 compressed digital video, and Dolby Digital audio.	You can record compressed digital video either <ul style="list-style-type: none"> • on compatible digital recorders as digital signals • as standard-definition composite video from the MONITOR OUTPUT jack converted to analog signals You may be unable to record some programming because of copy restrictions added by the content owners.

Before You Begin, continued

Connection Types

Video and Combined Audio/Video Connections





These descriptions apply to TV video only and do not cover signals from personal computers.

Picture Quality (most sources)	Name	Signal Type	Figures (not to scale)	Additional Information
Best (carry high-definition video when available)	HDMI	Digital audio and video	 	Carries digital audio and uncompressed digital video on a single one-way cable.
	DVI	Digital video	 	Carries uncompressed digital video alone on a single one-way cable; requires separate audio connections.
	Component Video	Analog video	 	Carries analog high-definition and standard-definition signals. Y Pb Pr RCA-style connectors are colored green, blue, and red.
Good	S-Video	Analog video	 	Carries analog standard-definition signals. Provides better quality video than composite or RF coaxial video.
Fair	Composite Video	Analog video	 	Carries analog standard-definition signals. RCA-style connector, usually colored yellow
Fair to Best (depending on source; carry all qualities of signals)	IEEE 1394 (FireWire®)	Digital audio and video	 	Carries compressed digital video and audio as well as device control signals on a single two-way cable.
	RF Coaxial Video	Analog and digital audio and video	 	Carries audio and video on a single cable.

Note: Only some TV signals are high-definition signals. To view high-definition programming from your cable or satellite provider, you must subscribe to the provider's high-definition service. Some over-the-air broadcasts are in high-definition and can be received with a high-quality antenna suited to your location.

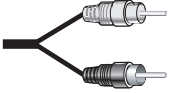
Audio-Only Connections

There are two types of audio connections used on this TV. Refer to the table below.

Audio Connection	Figures (not to scale)	Additional Information
Left/Right Analog Stereo Audio	 	RCA-style connectors usually colored white for left and red for right stereo audio. For monaural sound (all speakers playing the same sound), use only the white connector.
Digital Audio (Coaxial)	 	RCA-style connector usually colored orange. Use to send digital audio from the TV to your digital A/V receiver for surround-sound effects. Usually the only audio connection required between the TV and the A/V receiver.

Before You Begin, continued

Cable Management

Both TV models provide cable ties that help keep cables properly organized and connected, especially important when the swivel feature is used. For more information about the swivel feature, see *Manual and Power Swivel* in Chapter 1.

Cable ties #1-3 come attached to the back of the TV, and cable tie #4 is provided with the accessories and must be attached by TV owner. The number of cables that are connected to the TV will determine the number of cable ties that will be needed.

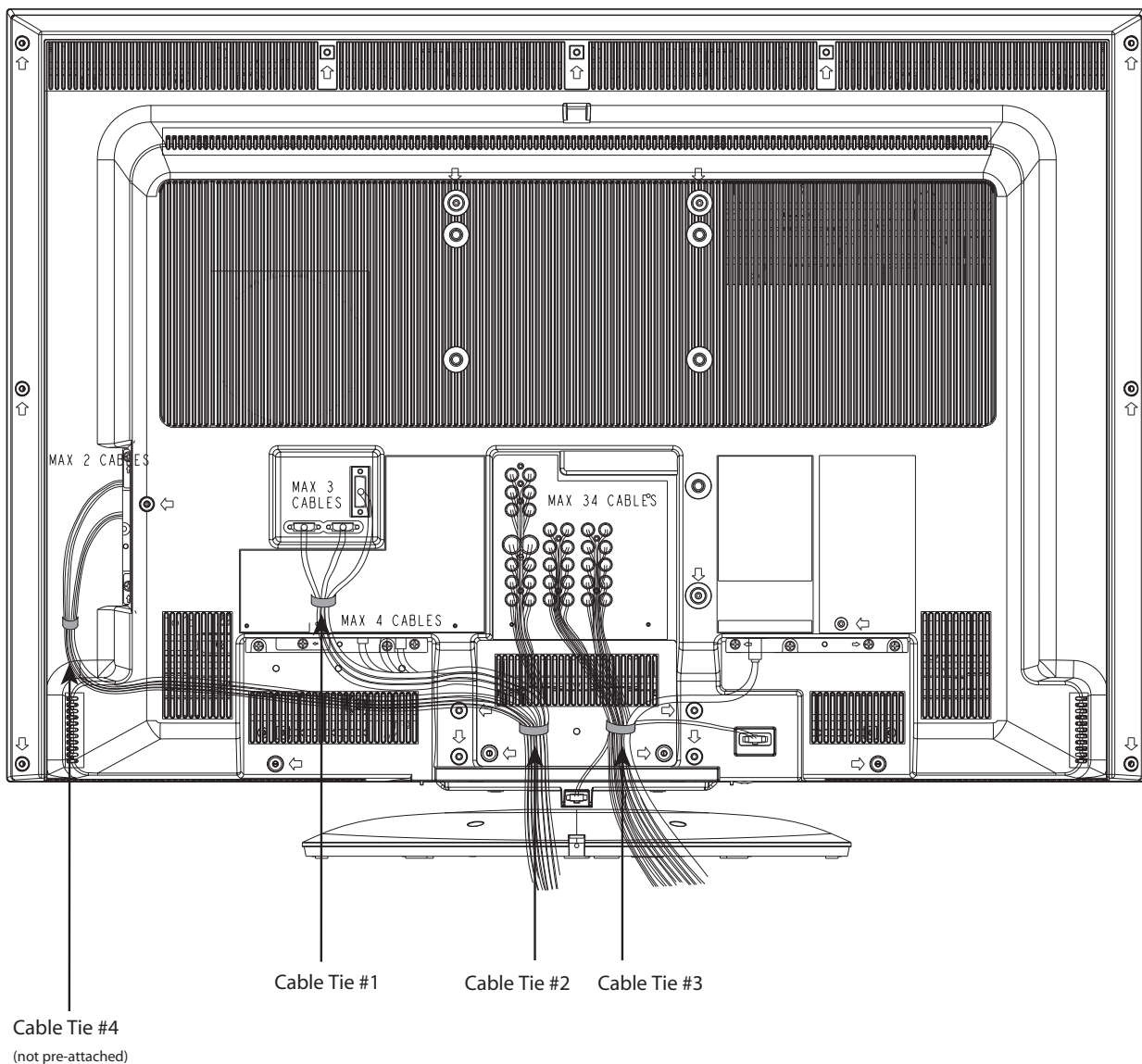

HDTV Cable Box or Satellite Receiver with Component Video

If your cable box or satellite receiver has HDMI or DVI outputs, use the connections for HDMI or DVI video devices described later in this chapter.

Required: RCA component video cables, left/right analog audio cables.

A coaxial splitter, available at most electronic supply stores, may be required to complete this installation.

1. Connect the cable from the outside cable or satellite service to **CABLE IN** or **SATELLITE IN** on the cable box or satellite receiver. See your device's owner's guide for instructions and cable compatibility.

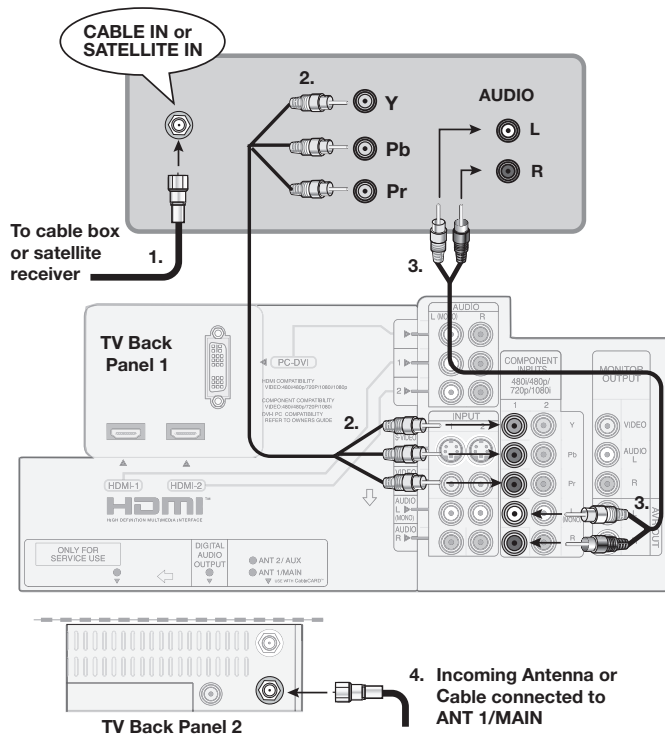

Figure 4. Connecting an external HDTV receiver with component video connections

2. Connect RCA-type cables from the Y Pb Pr outputs on the HDTV cable box or satellite receiver to **COMPONENT** on the TV back panel, matching the red, green and blue-colored connections.
3. Connect left (white) and right (red) audio cables from the HDTV cable box or satellite receiver to **COMPONENT /AUDIO LEFT** and **AUDIO RIGHT** on the TV back panel.
4. Optional: To allow use of the Split Screen feature with channels from **ANT 1** and the cable box or satellite receiver, connect the incoming terrestrial antenna or cable service (not satellite) to **ANT 1/MAIN** on the TV back panel. A coaxial splitter,

available at most electronics supply stores, may be required to complete this installation.

Note: To receive the benefits of digital surround sound, connect the digital audio output from your cable box or satellite receiver directly to your digital A/V receiver.

Standard Cable Box, Satellite Receiver, or Other Device with S-Video

Required: S-Video cable and left/right analog stereo audio cables.

1. Connect the cable from the outside cable or satellite service to **CABLE IN** or **SATELLITE IN** on the cable box or satellite receiver.
2. Connect an S-Video cable from **VIDEO OUT** on the cable box or satellite receiver back panel to **INPUT S-VIDEO** on the TV back panel.
3. Connect left (white) and right (red) audio cables from **AUDIO OUT** on the cable box or satellite receiver to **INPUT/AUDIO LEFT** and **AUDIO RIGHT** on the TV back panel.

Note: Refer to the cable box or satellite receiver Owner's Guide for cable or dish antenna connections to the receiver.

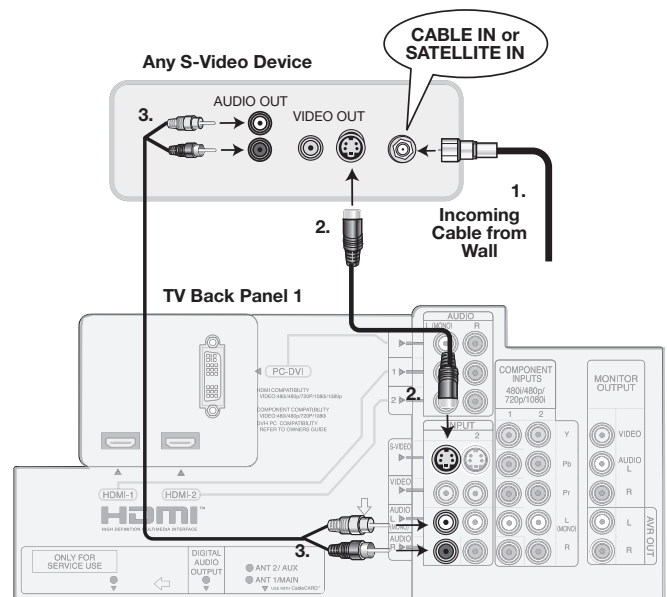

Figure 5. Connecting a device with S-Video

Wall Outlet Cable (no cable box)

(can be used with a CableCARD™)

It is very important to connect the incoming cable for your primary viewing source to **ANT 1/MAIN**, especially for CableCARD™ use.

1. Connect the primary incoming coaxial lead cable to **ANT 1/MAIN** on the TV back panel.
2. For an optional secondary antenna source, connect an antenna (or cable) to **ANT 2/AUX**.
3. If you have subscribed to a CableCARD™ service, Insert the CableCARD into the CableCARD slot. The top of the card must face in the direction indicated by the **CARD TOP** arrow.

See chapter 1, “Television Overview,” for additional CableCARD information.

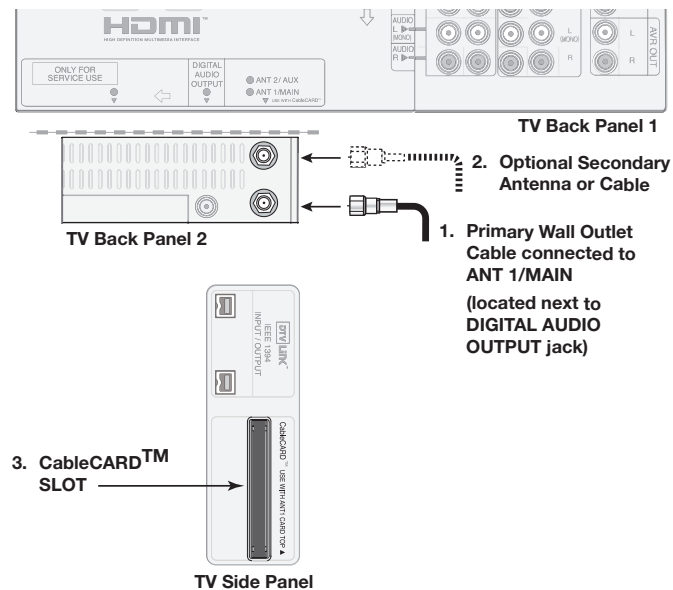

Figure 6. Wall Outlet Cable

Note: ANT 1 is located behind ANT2 when you are facing the back of the TV.

Antenna with a Single Lead

A. For an antenna with flat twin leads

A 300-ohm-to-75-ohm transformer is required. This is not included with the TV, but is available at most electronics stores.

- A1. For an antenna with flat twin leads, connect the 300-ohm twin leads to the 300-ohm-to-75-ohm transformer.
- A2. Push the 75-ohm side of the transformer onto **ANT 1** on the TV back panel.

B. For cable or antenna with coaxial lead

Connect the coaxial lead directly to **ANT 1** on the TV back panel.

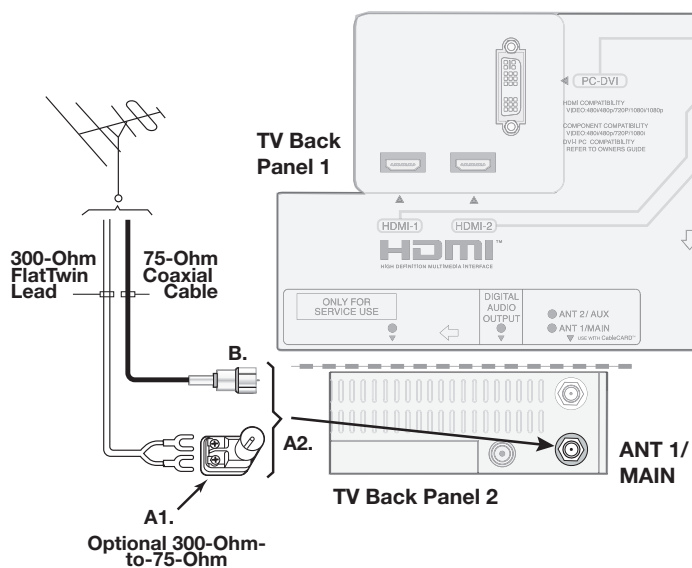

Figure 7. Connecting a Single Antenna

Note: ANT 1 is located behind ANT 2 when you are facing the back of the TV.

Antennas with Separate UHF and VHF Leads

Required: UHF/VHF combiner

This is not included with the TV, but is available at most electronics stores.

1. Connect the UHF and VHF antenna leads to the UHF/VHF combiner.
2. Push the combiner onto **ANT 1/MAIN** on the TV back panel.

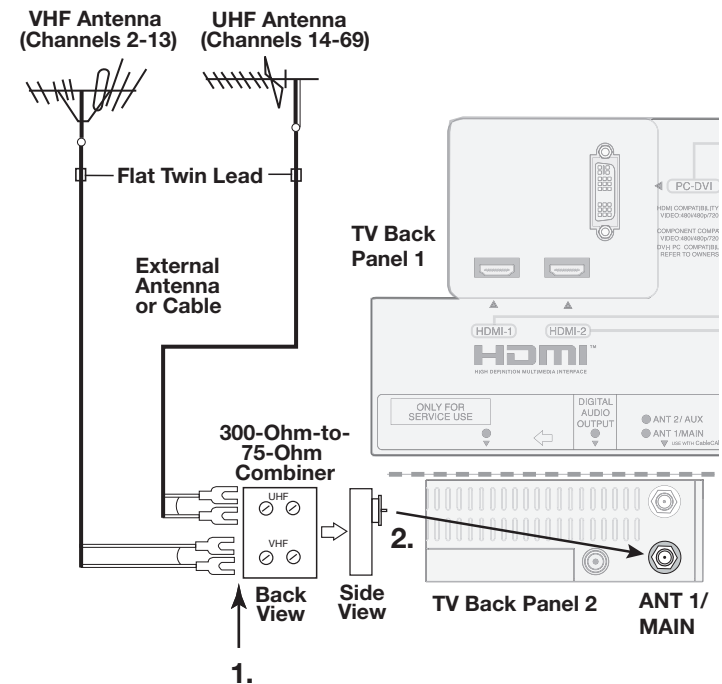

Figure 8. Connecting separate UHF and VHF Antennas

Note: ANT 1 is located behind ANT 2 when you are facing the back of the TV.

Mitsubishi strongly recommends you avoid using antennas with flat twin leads. Flat twin lead antenna wires are subject to interference which may adversely affect the performance of the TV. We recommend using coaxial antenna cable.

VCR to an Antenna or Wall Outlet Cable

Required: Two-way RF splitter, 3 coaxial cables, right and left analog audio cables, either S-video or video cable. These are not included with the TV but are available at most electronics stores.

1. Connect the incoming cable or antenna to **IN** on the RF splitter.
2. Connect one coaxial cable from **OUT** on the RF splitter to **ANTENNA IN** on the VCR back panel.
3. Connect one coaxial cable from **OUT** on the RF splitter to **ANT 1/MAIN** on the TV back panel.
4. To use the TV speakers with the VCR, connect left (white) and right (red) audio cables from **AUDIO OUT** on the VCR to **INPUT/AUDIO LEFT** and **AUDIO RIGHT** on the TV back panel. If your VCR is mono (non-stereo), connect only the white (left) cable.

5. Connect either an S-Video or composite video cable from **VIDEO OUT** on the VCR back panel to **INPUT/VIDEO** or **S-VIDEO** on the TV back panel. Connect only one type of video cable; S-Video is recommended, if available.

Optional

To record high-definition digital channels converted to analog standard-definition video and analog stereo audio, perform these two additional steps.

6. Connect left (white) and right (red) audio cables from **AUDIO IN** on the VCR to **MONITOR OUTPUT LEFT/RIGHT** on the TV back panel. If your VCR is mono (non-stereo), connect only the white (left) cable.
7. Connect a composite video cable from **VIDEO IN** on the VCR back panel to **MONITOR OUTPUT/VIDEO** on the TV back panel.

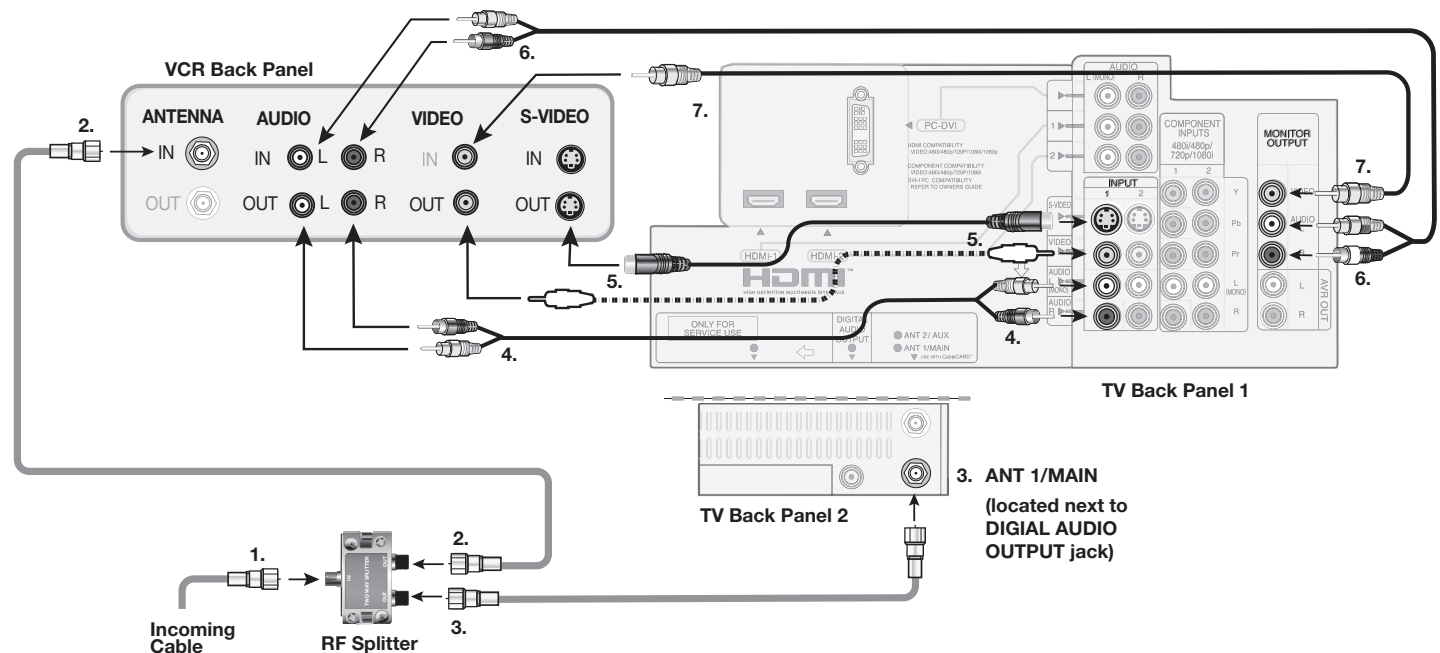

Figure 9. Connecting a VCR to an Antenna or Wall Outlet Cable

Note: ANT 1 is next to the DIGITAL AUDIO OUTPUT jack.

VCR to a Cable Box (Audio & Video)

Required: Two-way RF splitter, 4 coaxial cables, right and left audio cables, S-Video or composite video cable, plus component or S-Video cables and audio cables required to connect the TV to the cable box.

1. Connect the incoming cable to **IN** on the RF splitter.
2. Connect one coaxial cable from **OUT** on the RF splitter to **CABLE IN** on the cable box.
3. Connect one coaxial cable from **OUT** on the RF splitter to **ANT 1/MAIN** on the TV back panel.
4. Connect one coaxial cable from **OUT** on the cable box to **ANTENNA IN** on the VCR back panel.
5. Connect the cable box outputs to the TV as shown in either figure 4 or figure 5, earlier in this chapter. This connection allows the TV to receive the best available signal directly from the cable box.

Figure 4: Component video output to the TV's **COMPONENT Y Pb Pr** jacks; analog stereo audio to the associated **AUDIO** jacks.

Figure 5: S-Video output to the TV's **INPUT/S-VIDEO** jack; analog stereo audio to the associated **AUDIO** jacks.

6. To use the TV speakers with the VCR, connect left (white) and right (red) audio cables from **AUDIO**

OUT on the VCR back panel to **INPUT/AUDIO LEFT** and **AUDIO RIGHT** on the TV back panel. If your VCR is mono (non-stereo), connect only the white (left) cable.

7. Connect either an S-Video or composite video cable from **VIDEO OUT** on the VCR back panel to **INPUT/VIDEO** or **INPUT/S-VIDEO** on the TV back panel. Connect only one type of video cable. S-Video is recommended, if available.

Optional

8. To allow recording from the TV to the VCR:
 - a. Connect left (white) and right (red) audio cables from **AUDIO IN** on the VCR back panel to **MONITOR OUTPUT/LEFT** and **RIGHT** on the TV back panel.
 - b. Connect a video cable from **VIDEO IN** on the VCR back panel to **MONITOR OUTPUT/VIDEO** on the TV back panel.

Note: When using this connection configuration with the connections used in step 5, it is possible to view live cable programs through the VCR Device. For best picture quality always view live cable programs directly from the cable box device.

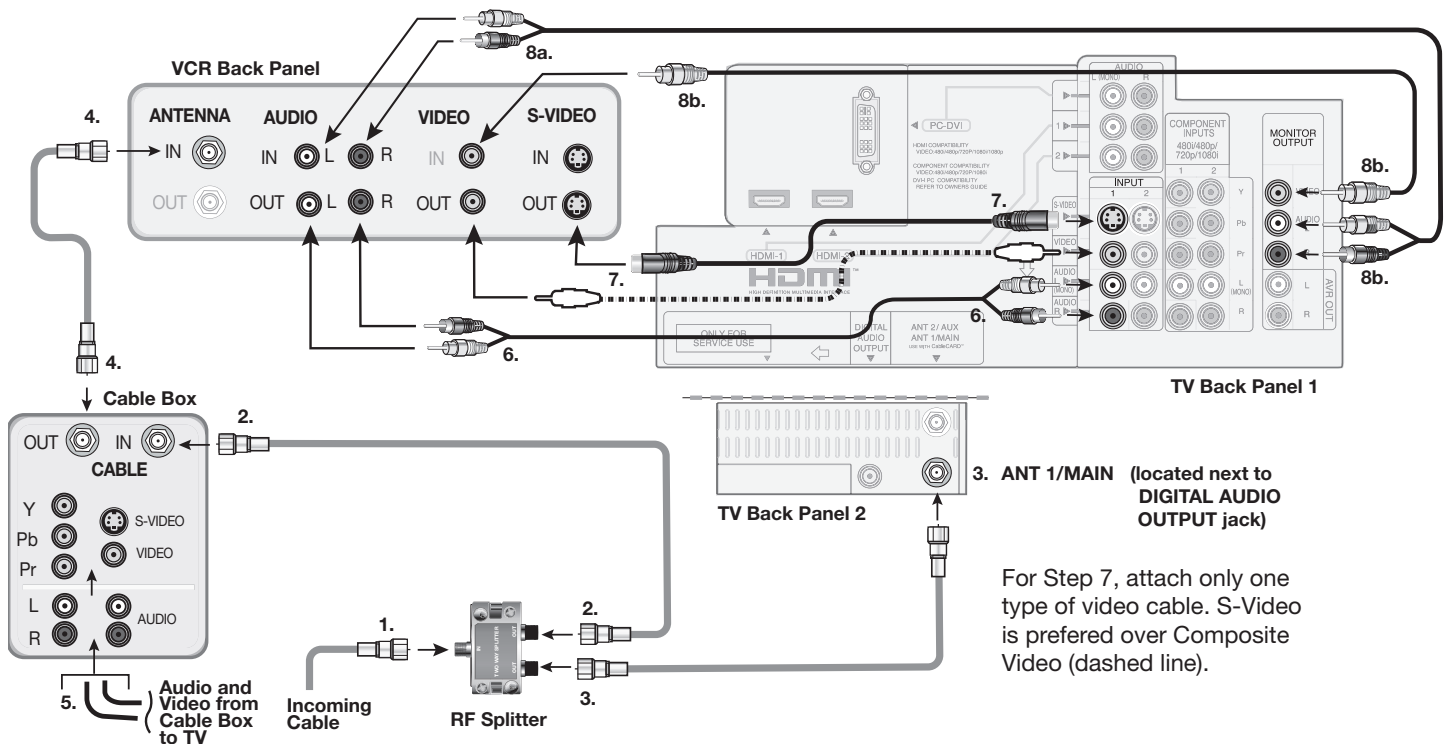

Figure 10. Connecting a VCR to a cable box

Note: ANT 1 is next to the DIGITAL AUDIO OUTPUT jack.

HDMI Device (Cable Box, Satellite Receiver, DVD Player, or Other Device)

Required: HDMI-to-HDMI cable. This is not included with the TV.

Connect an HDMI cable from the TV back panel to the HDMI device output. HDMI devices provide video and audio through this cable, so no other connection is required. You can connect two HDMI devices to the TV back panel through the HDMI connections.

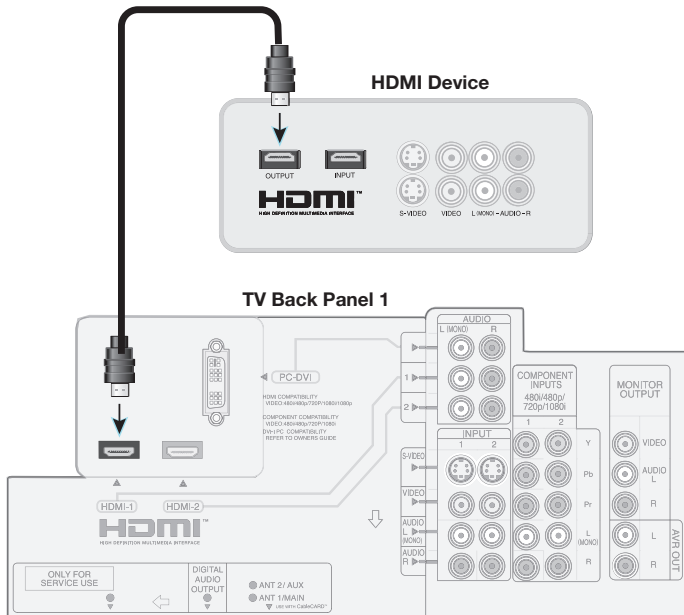

Figure 11. Connecting an HDMI device.

Note: HDMI inputs are *SimplayHD*™ certified for proper interoperability with other products certified by Simplay™.

DVI Video Device (Cable Box, Satellite Receiver, DVD Player, or Other Device)

Analog stereo audio cables and a DVI-to-HDMI cable or DVI/HDMI adapter and HDMI cable are required. These are not included with the TV. They may be available at your local electronics retailer.

1. Connect the DVI-to-HDMI cable (recommended) or HDMI cable with DVI/HDMI adapter from the DVI device's back panel to the TV back panel.

NOTE: If you are using a DVI/HDMI adapter, it is important to connect the adapter to the DVI device for best performance.

2. Connect a set of audio cables from **AUDIO OUT** on the DVI device back panel to the **HDMI/DVI AUDIO** on the TV back panel. Connect the red cable to the **RIGHT** jack and the white cable to the **LEFT** jack.

NOTE: The HDMI connection supports copy protection (HDCP).

Some devices require connecting to an analog input first, in order to view on-screen menus and to select DVI as the output. Please review your equipment instructions for DVI connectivity and compatibility.

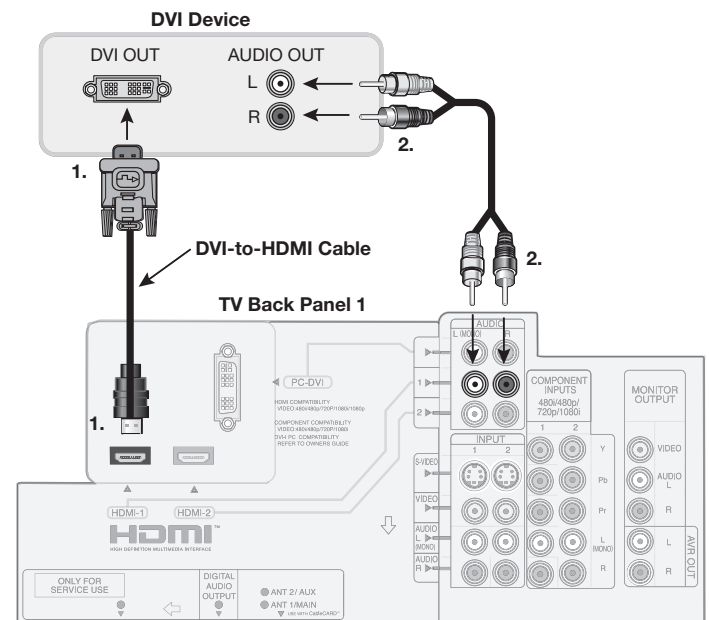

Figure 12. Connecting a DVI device

IMPORTANT

To connect a personal computer to the TV, see chapter 6, "Using the TV with a Personal Computer."

The HDMI input processes signals as standard motion video and is not designed to process computer resolutions.

DVD Player with Component Video

Component video cables and analog audio cables are required. These are not included with the TV.

1. Connect the component video cables from **Y PB PR VIDEO OUT** on the back of the DVD player to the **COMPONENT** jacks on the TV back panel, matching the red, green, and blue colored connections.
2. Connect left (white) and right (red) stereo audio cables from **AUDIO OUT** on the back of the DVD player to **COMPONENT/AUDIO LEFT** and **RIGHT** on the TV back panel.

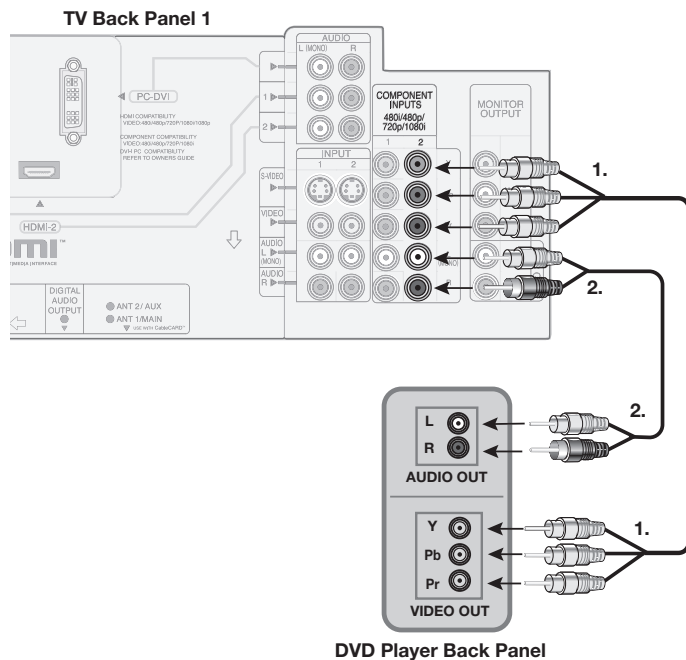

Figure 13. Connecting a DVD player with component video

A/V Receiver (Stereo System)

Most setups require either a digital audio cable or analog stereo audio cables.

The TV makes all audio available in digital and analog formats. Analog audio coming into the TV is available in digital format on the **DIGITAL AUDIO OUT** jack. Digital incoming audio is available in analog format on the **AUDIO OUT LEFT/RIGHT** jacks. Usually, only one of the following connections is required:

- **To connect an analog A/V receiver**
Connect left (white) and right (red) audio cables from **AVR OUT/LEFT** and **RIGHT** on the TV back panel to the **TV AUDIO INPUT** on the A/V receiver.
- **To connect a digital A/V receiver with Dolby Digital surround sound and PCM audio support**
Connect one end of the digital audio cable to **DIGITAL AUDIO OUT** on the back of the TV. Connect the other end to the **COAXIAL DIGITAL INPUT** on the back of the A/V receiver.

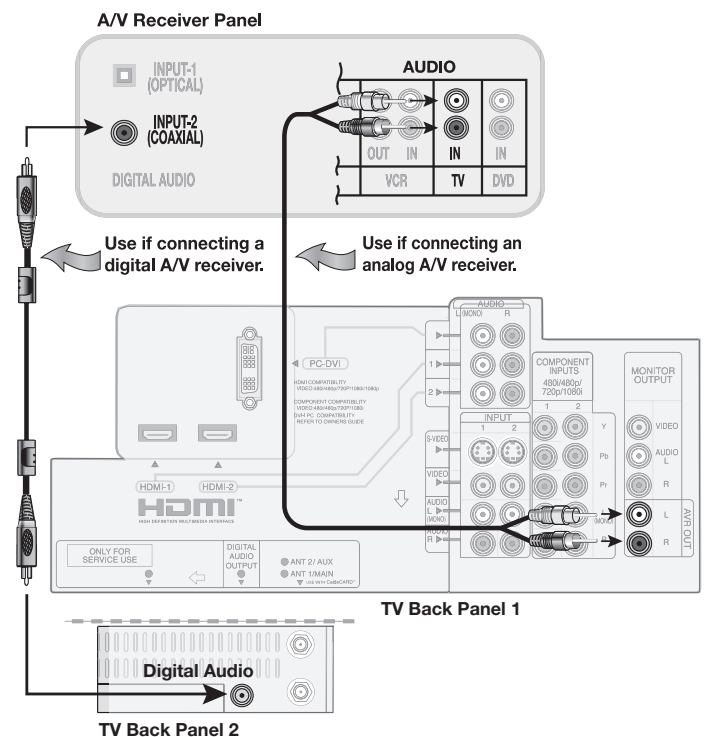

Figure 14. Connecting audio from the TV to an A/V receiver

Note:

- On rare occasions, an HDMI signal may be copy-restricted and cannot be output from the TV as a digital signal. To hear these copy-protected signals through the A/V receiver, use connections for analog A/V receivers.
- Check the A/V receiver's Owner's Guide for information concerning use of the digital input and switching between digital sound and analog stereo sound from the TV.

IMPORTANT

See Appendix B for component video signal compatibility information.

For digital audio connections to your A/V receiver, see your DVD player and A/V receiver Owner's Guides.

Older Cable Box

Required: 3 coaxial cables, one two-way RF splitter. These are not included with the TV.

When this setup is complete, you can use the TV remote control, when programmed, to change channels on the cable box.

Note: This connection is not recommended. The other connections described in this chapter provide better quality audio and video to the TV.

1. Connect the incoming cable to **IN** on the RF splitter.
2. Connect one coaxial cable from **OUT** on the RF splitter to **ANT 1/MAIN** on the TV back panel.
3. Connect one coaxial cable from **OUT** on the RF splitter to **IN** on the standard cable box.
4. Connect one coaxial cable from **OUT** on the cable box to **ANT 2/AUX** on the TV back panel.

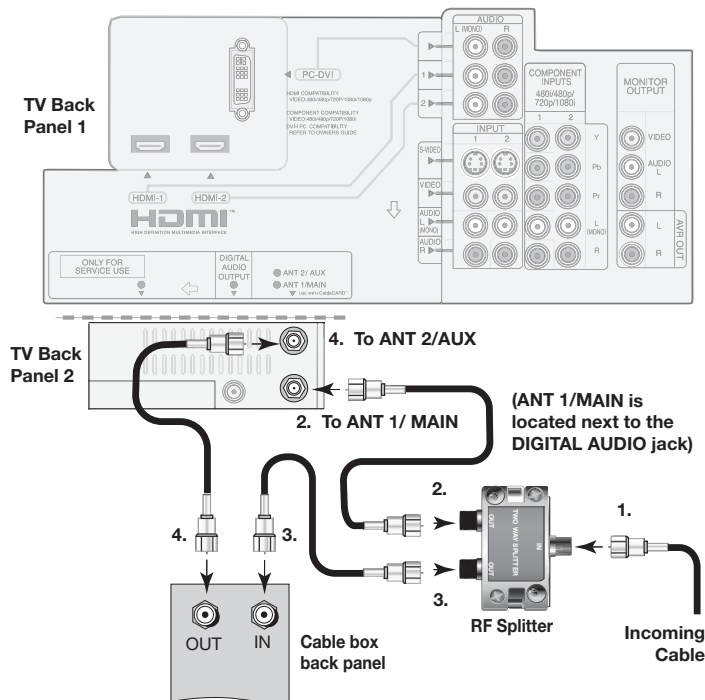

Figure 15. Connecting an older cable box

Note: ANT 1 is located behind ANT 2 when you are facing the back of the TV.

Camcorder

Required: Analog stereo audio cables and either an S-Video or composite video cable.

NOTE: For IEEE 1394 camcorders, see also chapter 7, "Using IEEE 1394 Devices."

1. Connect either an S-Video or composite video cable from **VIDEO OUT** on the camcorder to **INPUT 3/VIDEO** or **S-VIDEO** on the TV. Connect only one type of video cable; S-Video is recommended, if available.
2. Connect left (white) and right (red) audio cables from **AUDIO OUT** on the camcorder to **INPUT 3/AUDIO L** and **AUDIO R** on the TV.

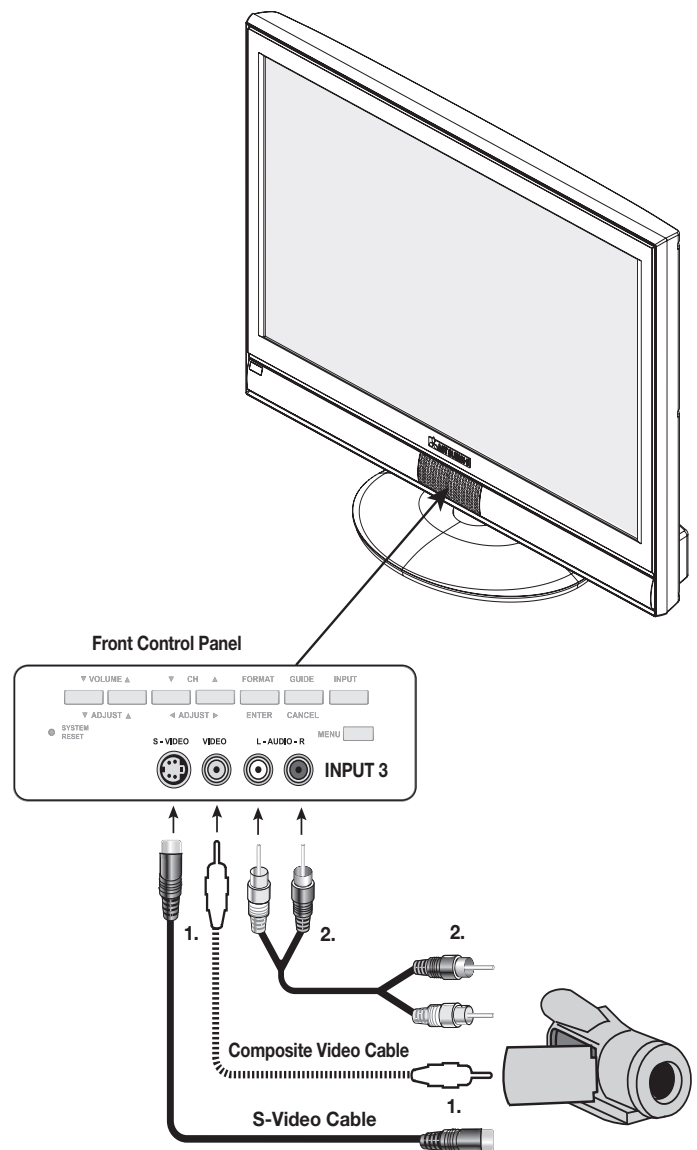

Figure 16. Analog connections for a camcorder

TV Operation

Remote Control	36
Choosing a Program Source	38
ChannelView™ Channel Listings	38
Status Display	39
TV Signals and Display Formats	40
Split Screen	42

Remote Control

Overview

See Figure 1, next page

1. **Slide Switch:** Selects the A/V device to be controlled by the remote control. Set the slide switch to TV for operation of the TV and IEEE 1394 devices. Control of other device types requires programming (see chapter 3, "TV Operation").
2. **SLEEP:** Sets the TV to turn off within 2 hours. See the next page for instructions.
3. **Digits/Letters:** Allow you to tune to a channel by entering channel numbers; press **ENTER** for faster tuning. Use numbers and the **CANCEL** key to enter digital sub-channels. Also use for entering information into menus.

To select letters when naming channels, repeatedly press the associated number key. The following special characters are available with the 1 and 0 keys:

1	!	&	blank space
0	/	*	-

4. **-/CANCEL (SUB-CHANNEL/CANCEL):** When entering digital channel numbers, adds a separator between main and sub-channel numbers. Clears FAV and some menu entries.
5. **POWER:** Turns TV power on and off.
6. **QV (QuickView™):** Switches between the current channel and the last channel viewed. This only applies to channels received from ANT 1 and ANT 2 jacks.
7. **MUTE:** Turns TV sound off or on.
8. **SPLIT:** Turns Split Screen mode on and off.
9. **VOL ^/∨ (Volume Up/Down):** Changes sound level.
10. **CH/PAGE ^/∨ (Channel or Page Up/Down):** Scans up or down through memorized channels. Pages up and down through screens when used with ChannelView™.
11. **FAV (Favorites):** Scans through memorized lists of favorite channels. See "Channel Menu" in chapter 4, "TV Menu Settings," for more information.
12. **FORMAT:** Changes the shape and size of the main TV picture. When in Split Screen mode, changes the size of the split images while maintaining their aspect ratios.
13. **INPUT:** Displays the **Input Selection** menu from which you can select an input source to view, such as an antenna input (**ANT 1/2**) or a connected device.

Note: To operate other audio/video devices:

- See chapter 5, "Programming the Remote Control" for instructions on programming.
- For control of IEEE 1394 devices, see chapter 7.

14. **▲ ▼ ◀ ▶ (Adjust Up/down/Left/Right):** Navigate menus and change settings.
 - ◀ ▶ **(Power) Swivel — LT-37131 model only:** With no menu or slider displayed, swivels the TV thirty degrees left or right. Swivel is not available in Split Screen mode.
15. **ENTER:** Selects a channel number or menu item.
16. **GUIDE:** Displays or removes ChannelView™ on-screen channel listing for **ANT 1** and **ANT 2**.
17. **INFO:** Displays an on-screen summary of the current device in use and any broadcast information available, including current V-Chip information. See chapter 3, "TV Operation," for details.
18. **AUDIO:** Selects individual audio settings for adjustment.
19. **VIDEO:** Selects individual video settings for adjustment, including **Swivel** (LT-37131 only; see item #14.)
20. **MENU:** Displays the main TV menu using the **ViewPoint** on-screen menu system. When a sub-menu is open, backs up one level.
21. **EXIT:** Closes all TV on-screen menus and displays and returns to normal TV viewing.
22. **F1-F4:** When programmed, work like the A, B, C, D buttons on some cable boxes and satellite receivers. Program the remote control for your equipment and test the keys. See chapter 5, "Operating Other A/V Devices with the Remote Control."
24. **⏸ (PAUSE):** Freezes a broadcast TV picture when no Split Screen image is displayed. When Split Screen is displayed, freezes the sub-picture. See below for use with recordable media.

Record/Playback Keys

To enable the recording and playback functions, program the remote for your VCR or DVD player/recorder and set the slide switch to **VCR** or **DVD**. See chapter 5 for instructions on programming the remote. If you have an IEEE 1394 device, see chapter 7 on IEEE 1394 devices.

23. **⏻ (RECORD):** Records with a VCR, DVR, or DVD recorder.
24. **⏸ (PAUSE):** Pauses a VCR, DVR or DVD. See above for use during TV viewing.
25. **■ (STOP):** Stops play of a VCR, DVR, or DVD.
26. **⏮ (REVERSE):** Rewinds a VCR. Reverse scans a DVR or DVD.
27. **▶ (PLAY):** Plays a VCR, DVR, or DVD.
28. **⏭ (FAST FORWARD):** Fast forwards a VCR. Forward scans a DVD or DVR.

Remote Control, continued

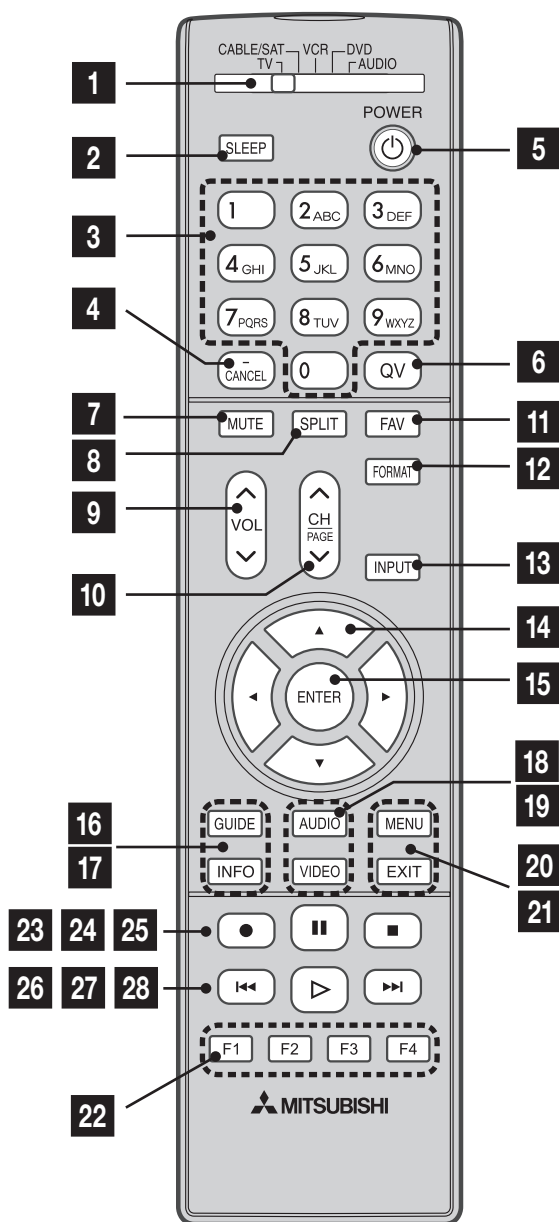

Figure 1. Remote Control Overview

Battery Installation

1. Remove the remote control's back cover by gently pressing in the tab and lifting off the cover (Figure 2).
2. Load the batteries, making sure the (+) and (-) polarities are correct. For best results, insert the negative (-) end first.
3. Snap the cover back in place.

Low Battery Indicator

If the **POWER** button blinks *five times* after you have pressed any button, the remote control batteries are low and should be replaced.

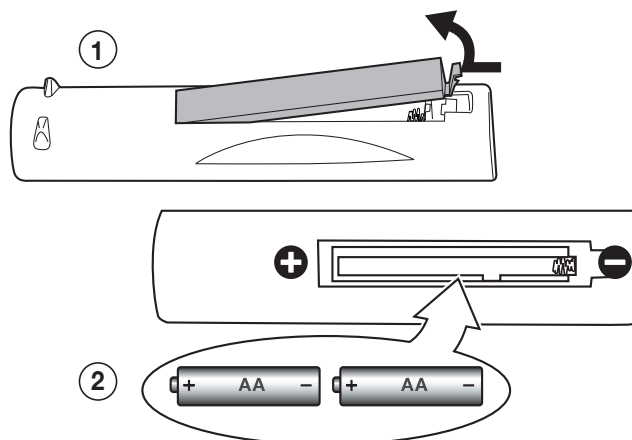

Figure 2. The remote control requires two AA alkaline batteries.

Sleep Timer

Setting the Sleep Timer

1. Press **SLEEP** on the remote control.
2. Press **SLEEP** additional times to increase the time in 30-minute increments up to the maximum of 120 minutes.
3. Press **EXIT** or wait five seconds without pressing any buttons for the message to disappear.
4. Press **SLEEP** to view the time remaining before the sleep timer turns off the TV.

Cancelling the Sleep Timer

1. Press **SLEEP** to display the on-screen message.
2. Press **SLEEP** repeatedly until **OFF** is displayed.

Note: After five seconds of inactivity, the message box will disappear.

Care

For Best Results from the Remote Control:

- Use only alkaline batteries.
- Be within 20 feet of the equipment.
- Do not press two or more buttons at the same time unless instructed to do so.
- Do not allow unit to get wet or become heated.
- Avoid dropping on hard surfaces.
- Do not use harsh chemicals to clean. Use only a soft, lightly moistened cloth.
- Do not mix old and new batteries.
- Do not heat, take apart, or throw batteries into fire.

Resetting the Remote Control

If the slide switch is set to **TV** and the TV does not respond properly, do the following to reset the remote control.

1. Press and hold **POWER** for several seconds until the button blinks twice and goes off.
2. Release the **POWER** button.
3. Press keys **0 0 9 3 5**. The **POWER** button will blink twice when you finish entering the code.

Choosing a Program Source

NOTE: If your only viewing sources are connected to the **ANT 1** and **ANT 2** antenna jacks, you can switch inputs without the Input Selection menu. Press **INPUT** to switch between **ANT 1** and **ANT 2**. To verify which is the current source while watching TV, press **INFO** to see the on-screen status display.

Selecting from Multiple Sources: The Input Selection Menu

The Input Selection menu allows you to select an input to watch on the TV. The current input appears as a gold-colored icon.

1. Press **INPUT** on the TV's remote control to display the Input Selection menu (Figure 2).
2. To select a different input, press **▲▼◀▶** on the TV's remote control to move the highlight through icons in the input section.
3. Press **ENTER** to switch to the device and close the menu.

More About the Input Selection Menu

- To assign meaningful labels to the icons, such as "VCR" or "DVD," see the "Input Name" section of chapter 4, "TV Menu Settings."
- To rearrange the icons, see the "Icon Order" section of chapter 4, "TV Menu Settings."
- To use with IEEE 1394 devices, see additional information in chapter 7, "Using IEEE 1394 Devices."

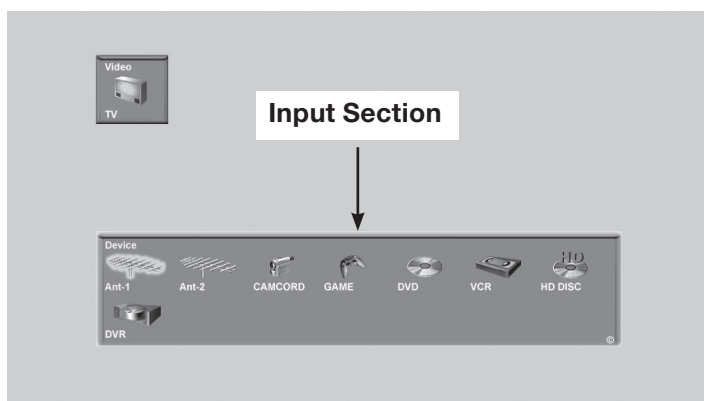

Figure 2. Input Selection menu

IMPORTANT

To receive ChannelView updates: Set the Energy Mode to Fast Power On and leave the TV powered off for a while each day. If the TV loses power, program listings will be lost until the next update.

ChannelView™ Channel Listings

ChannelView provides program information only when provided by the broadcaster for memorized digital channels on **ANT 1** or **ANT 2**. Digital channels are indicated with a "D" and analog channels with an "A."

Digital channels are shown with the major channel and sub-channels (or bitstreams). Analog channel names are shown only if they are named in the channel menu.

Note: If limited data is shown or no program data appears, it is because the broadcaster is not sending the information. *This is not a defect of your TV.*

Using ChannelView

Feature	Instructions
View listings while viewing ANT 1 or ANT 2 .	Press GUIDE .
Scan through memorized channels one by one.	Press ▲ or ▼ .
Scan quickly through memorized channels.	Press PAGE ▲/▼ .
View future program information for digital channels.	Press ▲ or ▼ to highlight a channel and press ▶ .
Return to viewing basic listings information	Press ◀ .

ChannelView™	5:47 pm, Friday, 4/28/06
2 CBS A Ant-1	
2-1 KCBS-DT D Ant-1	CBS Local News
4 A Ant-1	
4-1 KNBC-DT D Ant-1	NBC Evening News
7 ABC A Ant-1	
7-1 KABC-DT D Ant-1	ABC World News
28 PBS A Ant-1	
28-1 KCET-DT D Ant-1	The 2005 Rose Parade
28-2 KCET-DT D Ant-1	Nightly Business Report
30 A Ant-1	
62-101 D Ant-1	
62-102 D Ant-1	
128 CNN A Ant-1	
1104 KNBC-DT D Ant-1	NBC Evening News

Figure 3. ChannelView screen, current programs. Use **◀▶** to exchange displays for current and future programs.

ChannelView™	Programs for KCET Digital Int..
2 CBS A Ant-1	5:30 PM Nightly Business Report
2-1 KCBS-DT D Ant-1	6:00 PM NewsHour with Jim Leh...
4 A Ant-1	7:00 PM Life and Times
4-1 KNBC-DT D Ant-1	7:30 PM California's Gold
7 ABC A Ant-1	8:00 PM Washington Week
7-1 KABC-DT D Ant-1	8:30 PM Wall Street Week with F...
28 PBS A Ant-1	9:00 PM Now with Bill Moyers
28-1 KCET-DT D Ant-1	10:00 PM Culture of Hate: Who ar...
28-2 KCET-DT D Ant-1	11:00 PM Life and Times
30 A Ant-1	11:30 PM Charlie Rose
62-101 D Ant-1	12:20 PM Classic Arts Show
62-102 D Ant-1	
128 CNN A Ant-1	
1104 KNBC-DT D Ant-1	

Figure 4. ChannelView screen, future programs on the selected channel (digital channels only)

Status Display

The on-screen status display appears when you turn on the TV, change inputs, change channels, or press the **INFO** button on the remote control.

The most common displays are shown below. Seldom or never do all the status indicators appear at the same time.

Analog Program

1. Source Antenna or Input
2. Analog Channel being received (If an antenna source)
3. Channel Name (if named in the Channel menu)
4. Signal Type Being Received. Possible:
From **ANT-1**, **ANT-2**, or **INPUT** jacks: 480i
From **COMPONENT** jacks: 480i, 480p, 720p, 1080i
5. Screen Format in use
Possible:
Analog 480i /480p signals: Standard, Expand, Zoom, Stretch, Stretch Plus, Narrow
720p/1080i signals: Standard, Wide Expand
6. Stereo and/or SAP being broadcast. In Split Screen mode, the speaker icon is on either the left or right to indicate the sound source.
7. V-Chip Ratings
8. Channel is in current FAV bank (FAV bank 2)
9. Day and Time

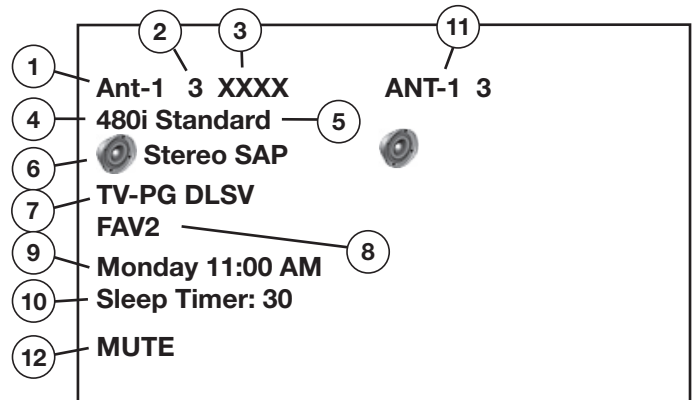

10. Sleep Timer remaining time
11. Split Screen picture source and channel
12. Audio Mute on

Digital Program

1. Digital Major and Sub-Channel Number
2. Digital Channel Name (only if broadcast)
3. Signal Type Being Received
Possible: SD 4:3, SD 16:9, HD
4. Screen Format in Use
Possible:
SD 4:3: Standard, Expand, Zoom, Stretch, Stretch Plus, Narrow
SD 16:9 or HD: Standard, Wide Expand
5. Language(s) being broadcast
6. Program Name (if broadcast)
7. Copy-Protection Status. Possible:
Copy Once: Program can be recorded
Copy Never: Program can never be recorded.

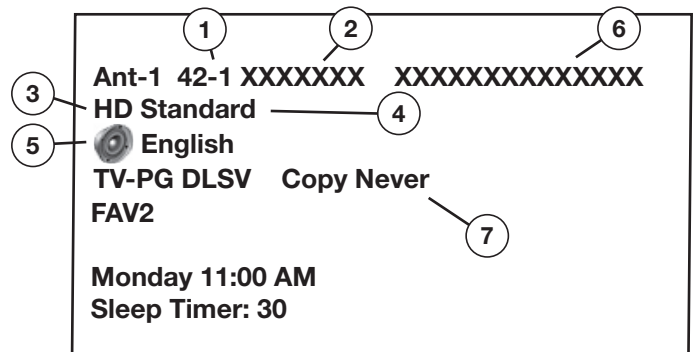

Digital IEEE 1394 Device

1. Status of D-VHS VCR or IEEE 1394 device
2. Counter of D-VHS VCR
3. Special message line (shows only when a special message is needed; may be seen with analog signals)
4. Copy-Protection Status. Possible:
Copy Once: Program can be recorded
Copy No More: Program can no longer be recorded; program may be moveable.
Copy Never: Program can never be recorded.

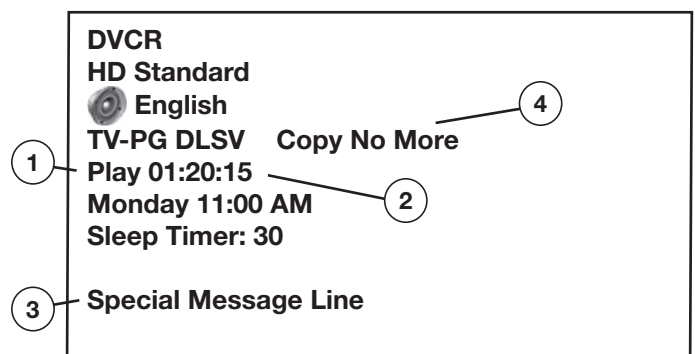

TV Signals and Picture Formats

This is a widescreen TV, also known as a 16:9 TV. This shape reflects the new types of picture formats available from HDTV and many DVDs. There are still many older style narrow-screen picture formats (for example, 4:3 aspect ratio) you will encounter. While there is no perfect solution for displaying a squarish, narrower image on a wide screen, Mitsubishi offers several picture formats from which you can choose.

Note: "Picture format" refers to the aspect ratio or the relative size/shape of the picture, such as 16:9 or 4:3.

Press **FORMAT** on the TV remote control to cycle through the available picture formats. The last-used format for each device is used when you return to that device.

Note: In Split Screen mode, the **FORMAT key changes the picture size on both sides of the screen, but the aspect ratio (relative height and width) of both pictures remains the same.**

DVD Definitions

Anamorphic (or Enhanced for WideScreen TV)

These DVDs are recorded in a special way to properly show widescreen pictures on 16:9 TV sets using the Standard format mode. This is the recommended viewing choice.

Non-Anamorphic (or 4:3, 1:33:1, Letter Box, or Full Screen)

These DVDs are recorded for use with traditionally shaped, squarish TVs. They may be full screen (4:3 or 1:33:1) which crops movies to fit the narrow TV, or letter box, which adds black top and bottom bars.

This information may be listed on the DVD case. Some DVDs support both types of recordings.

Signal Definitions

480i Signals: Traditional analog interlaced signals from or through **ANT-1** and **2**, **INPUT 1-3**, **COMPONENT 1** and **2**, **HDMI 1** and **2**.

480p Signals: Progressive-scan DVD signals on **COMPONENT** inputs and **HDMI 1** and **2**.

720p and 1080i Signals: High-definition signals received through **COMPONENT** inputs and **HDMI 1** and **2**. These signals are always 16:9 (widescreen).

1080p Signals: High-definition signals received through **HDMI 1** and **2**.

SD 4:3: Standard-definition narrow-screen format signals from digital channels and IEEE 1394 devices.

SD 16:9: Standard-definition widescreen format signals from digital channels and IEEE 1394 devices.

HD: High-definition wide-screen format signals from digital channels and IEEE-1394 devices. These signals are always 16:9 (widescreen).

TV Picture Format Definitions

Standard: This is the full-screen format. HDTV signals use this format. This format is useful for displaying Anamorphic DVDs that have 1.78:1 or 1.85:1 aspect ratios. Anamorphic DVDs that have a 2.35:1 aspect ratio are displayed with black bars at the top and bottom, but show the entire picture correctly. Narrow (4:3) pictures are stretched evenly from side to side. Available for all signals.

Expand: This enlarges the picture to fill the screen, cropping off some of the image at the top and bottom. This is useful for reducing the letter box top and bottom bars of non-anamorphic DVD images. Available for 480i, 480p, and digital SD 4:3 signals only.

Zoom: This enlarges the picture, cropping off some of the image at each side and top and bottom. This is useful for removing or reducing the black top and bottom bars on anamorphic DVDs with a 2.35:1 aspect ratio. Available for 480i and 480p and SD 4:3 signals only.

Stretch: This format stretches a narrow (4:3) picture across the screen; there is less stretch in the center than at the sides, however. This allows the entire narrow image to be displayed across the screen with less distortion than is seen in the Standard format. Available for 480i and 480p and SD 4:3 signals only.

Stretch Plus: Similar to stretch mode, but to minimize distortions on the side, the picture is expanded to crop off portions of the top and bottom. Except when displaying menus, press **▲▼** to adjust the position of the picture vertically. Available for 480i and 480p and SD 4:3 signals only.

Narrow: This format displays narrow (4:3) pictures in their original shape, and adds stationary black side bars to fill the screen. Available for 480i, 480p and SD 4:3 signals only.

Wide Expand: Enlarges the picture, cropping some of the image on both sides. This Expand format is useful to remove or reduce black side bars added to narrow pictures that are converted to 16:9 signals for digital broadcast. Available for 1080i, 720p, digital SD 16:9 and digital HD signals.

Note: All high-definition channels send widescreen (16:9) signals, but not all programming sent on these channels was created for this format. As a result, the broadcaster must convert such programming for broadcast, and may stretch the picture or add side bars to fill the widescreen area.

TV Picture Formats

See descriptions on the preceding page.

ORIGINAL SIGNAL
Non-anamorphic or SD 4:3

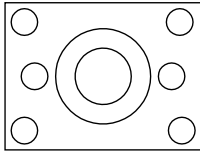

ORIGINAL SIGNAL
Anamorphic DVD

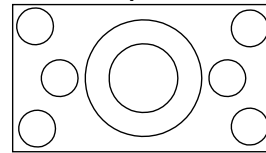

TV Display

Standard

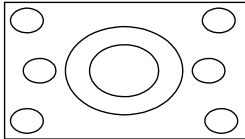

(not recommended, distorted)

TV Display

Standard

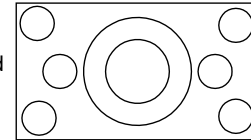

(recommended)

Expand

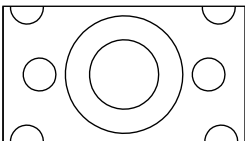

(recommended for letterboxed)

not available for
HD, SD 16:9 or
analog 720p, 1080i

Expand

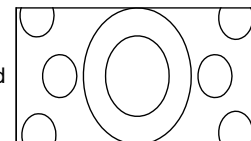

(not recommended, distorted)

not available for
HD, SD 16:9 or
analog 720p, 1080i

Zoom

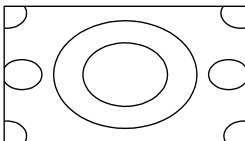

(not recommended, distorted)

not available for
HD, SD 16:9 or
analog 720p, 1080i

Zoom

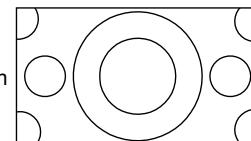

(recommended for anamorphic 2.35:1)

not available for
HD, SD 16:9 or
analog 720p, 1080i

Stretch

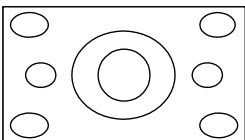

(recommended for standard broadcast)

not available for
HD, SD 16:9 or
analog 720p, 1080i

Stretch

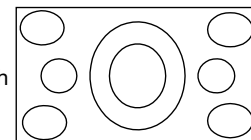

(not recommended, distorted)

not available for
HD, SD 16:9 or
analog 720p, 1080i

Stretch Plus

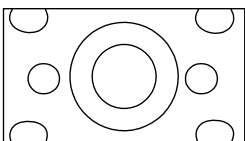

(recommended for standard broadcast)

not available for
HD, SD 16:9 or
analog 720p, 1080i

Stretch Plus

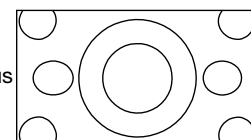

(not recommended, distorted)

not available for
HD, SD 16:9 or
analog 720p, 1080i

Narrow

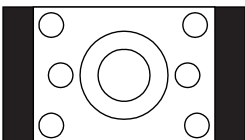

Narrow

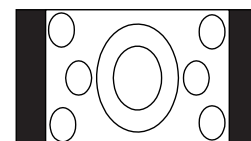

(not recommended, distorted)

not available for
HD, SD 16:9 or
analog 720p, 1080i

**SD 16:9 or
HD Digital**

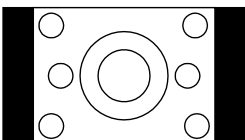

(with side bars in broadcast)

Standard
Original HD or SD
16:9, 720p or 1080i

Wide Expand

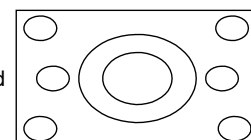

(recommended to remove side bars)

available only for
digital SD 16:9, HD,
analog 1080i or 720p

Split Screen

Split Screen allows you to view pictures from two different sources at the same time. Split Screen is available when you have video sources connected to the TV in addition to any connections to **ANT 1** and **ANT 2**.

Operation

Split Screen Operations	Instructions
Turn Split Screen on or off	Press SPLIT .
Switch the sound source between main and sub-pictures.	The speaker icon appears briefly over the active picture (main or sub-picture). The side that is active will be controlled by the remote control. Press ◀ or ▶ switch between main and sub-picture sides. 
Check which picture is the sound source.	Press INFO . The speaker icon appears in the information display to indicate the sound source.
Change the source of the sub-picture.	<ol style="list-style-type: none"> Press ▶ to make the sub-picture the sound source. Press INPUT and move the highlight to the icon for the input you wish to view as the sub-picture (see figure 5). Press ENTER to make the change. <p>Grayed-out input icons are unavailable as Split Screen sources or with the current source.</p>
Change channels (when the input source is ANT 1 or ANT 2).	<ul style="list-style-type: none"> Press CH ^/∨. With the main picture as the sound source, enter the channel number and press ENTER.
Freeze or unfreeze the sub-picture.	Press PAUSE (⏸). Press PAUSE (⏸) again to return to normal moving video.
Change the size of the main and sub-pictures.	Repeatedly press FORMAT to cycle through picture sizes. See the following page for sample displays.
Make the sub picture fill the screen.	<ol style="list-style-type: none"> Press ▶ to make the sub-picture the sound source. Press SPLIT to close Split Screen mode.

“**SPLIT**” appears under the **Video** icon to distinguish this menu from the Input Selection menu.

Choice of Split Screen sub-Picture Sources

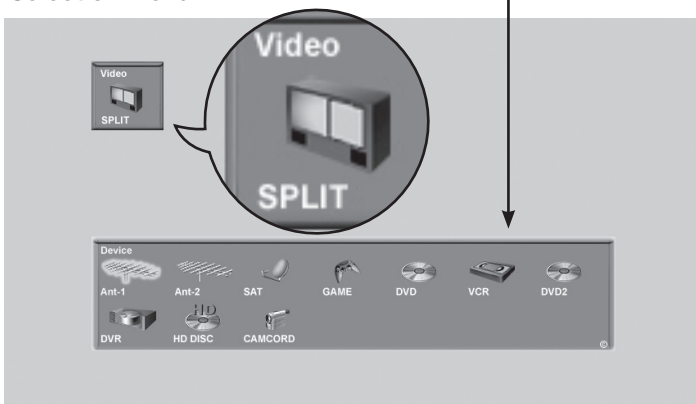

IMPORTANT

Split Screen is not available if your only inputs are **ANT 1** and **ANT 2**.

IMPORTANT

PCs and HDMI 1080p devices cannot display in the Split Screen sub-picture.

Figure 5. Change the source of the sub-picture with the Split Screen Input Selection menu.

Split Screen Displays

**16:9 Main Picture/
4:3 Sub-Picture**

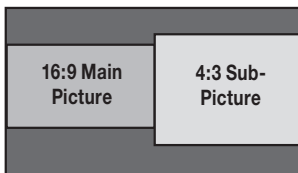

Press **FORMAT**

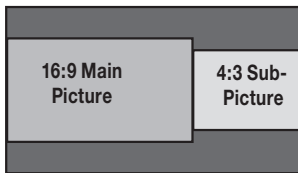

Press **FORMAT**

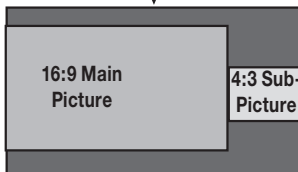

**16:9 Main Picture/
16:9 Sub-Picture**

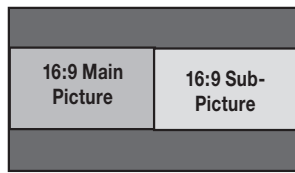

Press **FORMAT**

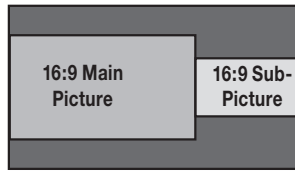

Press **FORMAT**

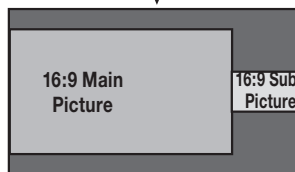

**4:3 Main Picture/
4:3 Sub-Picture**

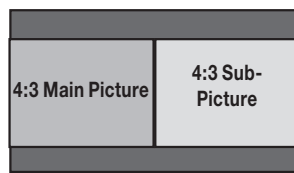

Press **FORMAT**

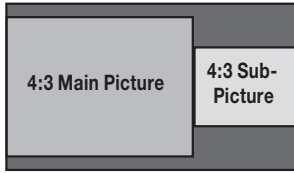

Press **FORMAT**

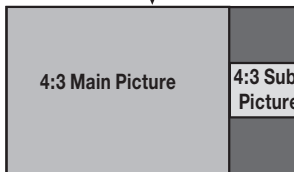

**4:3 Main Picture/
16:9 Sub-Picture**

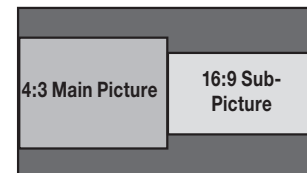

Press **FORMAT**

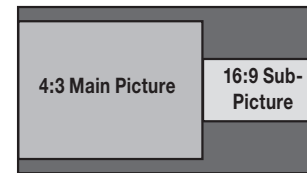

Press **FORMAT**



Display choices. Press the **FORMAT** key repeatedly while in Split Screen mode to view different displays.

Note: When PC or HDMI 1080p is the signal source for the Main picture, only one size combination is available. Pressing the Format button will not change the size of the images.

TV Inputs for Split Screen

The available Split Screen picture sources are listed below.

Available as either main picture or sub-picture	<ul style="list-style-type: none"> Analog channels Devices on VIDEO/S-VIDEO inputs Devices on COMPONENT inputs Devices on either HDMI 1 or 2 inputs. <i>Note: The main and sub-picture can not both have HDMI inputs.</i>
Available as main picture only	<ul style="list-style-type: none"> Digital channels received from HDMI 1080p PC

Combinations of picture sources you can view with Split Screen. Check marks indicate available combinations.

Main Picture \ Sub-Picture	ANT 1	ANT 2	INPUT	COMPONENT	HDMI 1 (no 1080p)	HDMI 2 (no 1080p)	IEEE 1394
ANT 1			✓	✓	✓	✓	✓
ANT 2			✓	✓	✓	✓	✓
INPUT	✓	✓	✓*	✓	✓	✓	✓
COMPONENT	✓	✓	✓	✓**	✓	✓	✓
HDMI 1 & 2	✓	✓	✓	✓			✓
IEEE 1394	✓	✓	✓	✓	✓	✓	
PC-DVI							✓

* Only when main picture and sub-picture are from different **INPUT** jacks

** Only when main picture and sub-picture are from different **COMPONENT** jacks

Manual and Power Swivel

Both TV models allow you to swivel the TV manually up to 30 degrees from left to right. In addition, the LT-37131 model has the Power Swivel feature, which automatically swivels the TV left or right when you press the ◀ or ▶ buttons on the remote control.

To use the Power Swivel feature for LT-37131:

1. Be sure no menu or slider (such as the Volume slider) is displayed.
2. Press the ◀ or ▶ buttons to swivel the TV thirty degrees left or right.

Note: Power Swivel is not available while the TV is in Split Screen mode.

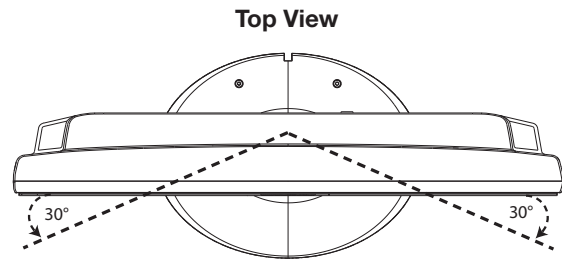

TV Menu Settings

3D Graphical ▶ViewPoint® Menu System	46
Main Menu	47
Setup Menu	48
Input Name Menu	50
Icon Order Menu	50
Channel Menu	51
Captions Menu	53
Parental Lock Menu	55
Setting a Pass Code	55
Lock TV by Time and Front-Panel Lock	55
Rating Menus	55
Bypassing the Ratings Lock and Lock by Time	57
V-Chip Signal Information	
TV Ratings	58
Movie Ratings	58
Audio/Video Menu	59
Audio Settings.	60
Video Settings.	61

3D Graphical ▶ViewPoint® Menu System

Your TV has Mitsubishi's exclusive 3D Graphical ▶ViewPoint® on-screen operating system, which provides on-screen information for menu choices and changes using the TV's remote control.

▶ViewPoint® Menu Screens



A picture (icon) is highlighted on the menu screen when selected with the directional arrows ▲▼◀▶. You may then make changes within the menu or access sub-menus, if available.



You can also open sub-menus from a button. Sometimes when you select a button, an automatic function begins.

The ▶ViewPoint® system includes the following special features:

- The currently selected icon or button is highlighted with a yellow outline; the text color is yellow.
- On-screen instructions, shown in the message line at the bottom of the menu, provide feature selection and adjustment information.
- Some on-screen menu options must be set before other options are available.

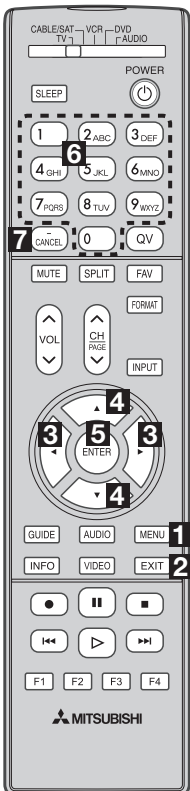

▶ViewPoint® Remote Control Buttons

The following buttons on the remote control help you navigate within the ▶ViewPoint® system:

Key	Function
1 MENU	Display or close the Main menu or move back one menu screen at a time.
2 EXIT	Close all menus and return to TV viewing.
3 ◀▶ (Adjust Left/Right Keys)	◀▶ to select a menu item to change.
4 ▲▼ (Adjust Up/Down Keys)	<ul style="list-style-type: none"> • to change the settings. • to scroll through pre-set text-box entries.
5 ENTER	Open a menu, start an automatic function, or select a check box.
6 Numbers, Letters	Enter custom names in some text boxes.
7 CANCEL	Clear a setting or stop an automatic function.

Main Menu

Press **MENU** on the remote control to open the Main menu, figure 1. See below for an overview of the options available through the Main menu.



Figure 1. Main menu.



Setup

- ◆ Select English or Spanish for menus and on-screen displays.
- ◆ Memorize the available channels for the antenna or cable service connected to the **ANT 1** and **ANT 2** jacks.
- ◆ Set the TV's internal clock either manually or have the TV set the clock automatically.
- ◆ Set the TV Timer to turn on the TV automatically at a designated time.
- ◆ Set the energy mode for power consumption when the TV is powered off.
- ◆ Turn off Demo Mode.
- ◆ View the TV's software version.



Input Name

- ◆ Assign useful names to TV inputs so that you can easily find them in the Input Selection menu.
- ◆ Select analog or digital PC DVI signal types.



Icon Order

Rearrange icons in the Input Selection menu to put frequently used icons first.



Channel

- ◆ Edit channels for the **ANT 1** and **ANT 2** inputs.
- ◆ Manually add or delete channels from memory, name analog channels, or add your favorite channels to a **FAV** (Favorites) list.
- ◆ View signal strength of a currently tuned digital channel.



Captions

- ◆ Display closed captions (if sent by the broadcaster).
- ◆ Select settings for analog or digital captions.



Parental Lock

- ◆ Block or allow programming based on rating signals sent by the broadcast station.
- ◆ Lock the TV by time.
- ◆ Lock the front-panel buttons.



Audio/Video

- ◆ Reset a selected device's A/V memory to the original factory settings.
- ◆ Customize individual audio and video settings.
- ◆ Display a blue screen when viewing a device with no video signal or a poor video signal.
- ◆ Enable/disable Film Mode.
- ◆ Turn the TV speakers on or off.

Setup Menu



Figure 2. Setup menu

Language (Setup Menu)

Choose to display the on-screen menus in either English or Spanish (Español).

To listen to audio in other languages (when available), see the “Audio Settings” section in this chapter and refer to “SAP” (analog signal) or “Language” (digital signal).

Memorize Channels (Setup Menu)

For ANT 1/MAIN and ANT 2/AUX

The memorization process performs two scans of all possible channels on the selected **ANT** input. Analog channels are scanned first, then the process is repeated for digital channels. Channel memorization may take up to 15 minutes to complete.

To start channel memorization

1. Highlight an input selection based on your connections:

Input	Condition
Ant 1 Air, Ant 2 Air	When connected to an indoor/outdoor antenna
Ant 1 Cable, Ant 2 Cable	When connected to direct cable (no cable box)

2. Press **ENTER** to start automatic channel memorization.

To stop channel memorization before completion

Press **CANCEL**.

Channels memorized before you pressed **CANCEL** are retained in memory. If you restart memorization, all previously memorized channels for the selected antenna input are erased and the process starts over from the beginning.

After channel memorization, press **CH** \wedge/\vee to tune to memorized channels. Select the Channel menu for further channel editing, such as adding and deleting channels from memory, naming channels, and saving favorite channels in custom memory banks.

Note: If using a CableCARD™, the complete list of available channels is provided through the CableCARD and the **ANT 1** option is grayed out.

Clock (Setup Menu)

Set the clock if you wish to use the TV’s Timer function or schedule delayed recordings. You can use either the manual or auto method to set the clock.

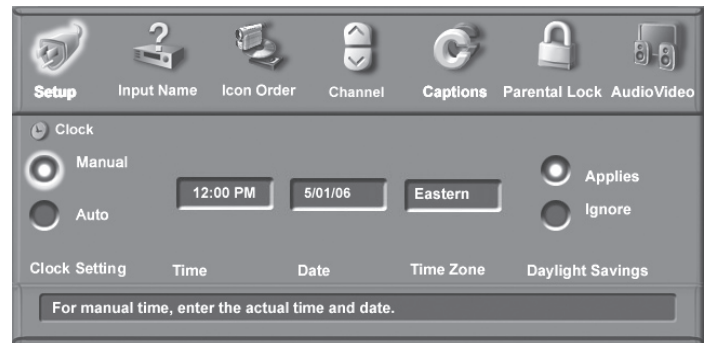

Figure 3. Clock submenu

Setting the Clock Manually

Time

With the hour highlighted in yellow characters, press \blacktriangle \blacktriangledown repeatedly to slowly increment the hour and associated **AM/PM** indicator or press and hold to quickly increment the hour. Press **ENTER** to highlight the minutes in yellow. Press \blacktriangle \blacktriangledown to set the minutes.

Date

With the month highlighted in yellow characters, press \blacktriangle \blacktriangledown to select the correct month. Press **ENTER** to highlight the day. Press \blacktriangle \blacktriangledown to select the correct day. Press **ENTER** to highlight the year. Press \blacktriangle \blacktriangledown to select the current year.

Time Zone

Select your correct time zone. Press \blacktriangle or \blacktriangledown to select the time zone for your area (**Atlantic, Eastern, Central, Mountain, Pacific, Alaska** or **Hawaii**). Press \blacktriangleright to move to the **Daylight Savings** option.

Daylight Savings

Press \blacktriangle or \blacktriangledown to select either **Applies** or **Ignore**, depending on whether or not daylight savings time is used in your area.

Note: If **Clock Setting** is set to **Manual**, each time the time change occurs, you must open this menu and set the TV’s clock ahead or back.

If you have selected **Auto** for **Clock Setting**, the TV’s clock adjusts automatically to daylight savings time.

Setting the Clock Automatically

Select the **Time Zone** and the **Daylight Savings** (DST) options for your state. Press \blacktriangle \blacktriangledown to select **Applies** or **Ignore**. You may then tune to a channel on **ANT 1** or **ANT 2** that uses Extended Data Service (XDS) time data,

Setup Menu, continued

typically a PBS channel. With **Auto** selected, the TV automatically retrieves the correct time and date information from this channel.

Be aware that if a channel displays incorrect time information, it is because of information sent from the broadcaster and is not a defect of the TV.

Note: You may find that some channels send the incorrect time and the TV clock is reset every time you tune to those channels. To prevent unwanted clock resets, first use the **Auto** method to set the clock from a channel sending the correct time, then change the method to **Manual**.

Timer (Setup Menu)

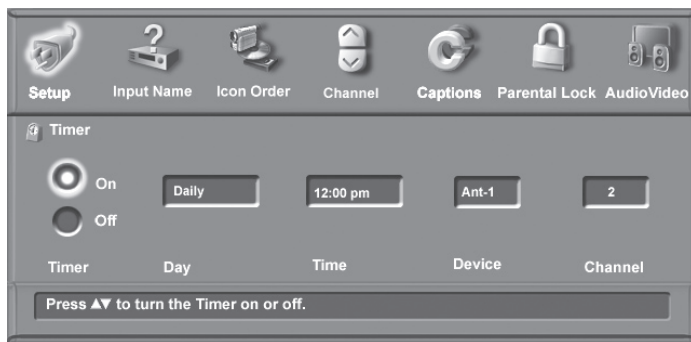

Figure 4. Timer submenu

The Timer feature allows you to set a day and time for the TV to turn on automatically and the device and channel to display when it switches on. If the TV is already on at the requested time, the TV automatically tunes to the channel you designated in the Timer menu.

When the Timer turns on the TV, the following message is displayed: “Press a button for the TV to stay on.” Press any button on the remote control within five minutes if you wish the TV to remain on.

Note: The TV clock must be set before you can use the Timer feature (see preceding page to set the clock).

On/Off

Press ▲ ▼ to enable or disable the Timer.

Set Day

Select the day or days that the TV will turn on automatically. Press ▲ or ▼ to select **Daily**, **Mon-Fri** (Monday through Friday), or individual days of the week.

Set Time

With the hour highlighted in yellow characters, press ▲ ▼ repeatedly to slowly increment the hour and associated **AM/PM** indicator or press and hold to quickly increment the hour. Press **ENTER** to highlight the minutes. Press ▲ ▼ to set the minutes.

Device

Press ▲ or ▼ to select the device to use when the Timer turns on the TV. If the TV is already on at the selected time, the Timer will switch the TV to this device.

Channel

When the selected device is an antenna, you can select a channel for the TV to tune to when it comes on. Highlight the **Channel** box and

- press **CH** ^/∨ or ▲ ▼ to choose from memorized channels.
- Enter a channel number from the remote control. You can also enter sub-channel numbers for digital channels.

Energy Mode (Setup Menu)

The Energy Mode option lets you select the TV's level of power consumption while the TV is turned off. Choose either **Low Power** or **Fast Power On**. The **Low Power** setting uses less energy, but TV power-on takes longer. The default is **Fast Power On**. Keep this setting at **Fast Power On** if you:

- Need faster power on.
- Wish to turn off the TV while recording to an IEEE 1394 device.
- Wish to schedule future IEEE 1394 recordings for a time when the TV will be off.
- Expect to use the TV Timer function to turn on the TV at a preselected time.
- Need the TV Clock to remain accurate for the TV Timer and for scheduling recordings. With the **Low Power** setting, you must reset the TV Clock if the TV is left turned off for over 48 hours.
- Wish to receive updates to the ChannelView™ channel listings.

Note: CableCARD™ requires the **Fast Power On** setting. If you insert a CableCARD™, the TV will automatically override a **Low Power** setting and change to the **Fast Power On** setting.

Demo Mode Off (Setup Menu)

Some TVs are shipped from the factory with Demo Mode active for use in retail stores. If Demo Mode is active, highlight the **Demo Mode Off** button and press **ENTER**.

Software Version (Setup Menu)

For servicing purposes it may be necessary to know the software version in your TV. This information is displayed at the right side of the Setup menu screen.

Input Name Menu

Use the Input Name menu to assign useful labels to the TV inputs that appear in the Input Selection menu. Unused inputs appear grayed out and unselectable.

Use the **PC DVI** option to specify the type of video signal coming from your computer, either **Analog** or **Digital**. For more about this option, see chapter 6, "Using the TV with a Personal Computer."

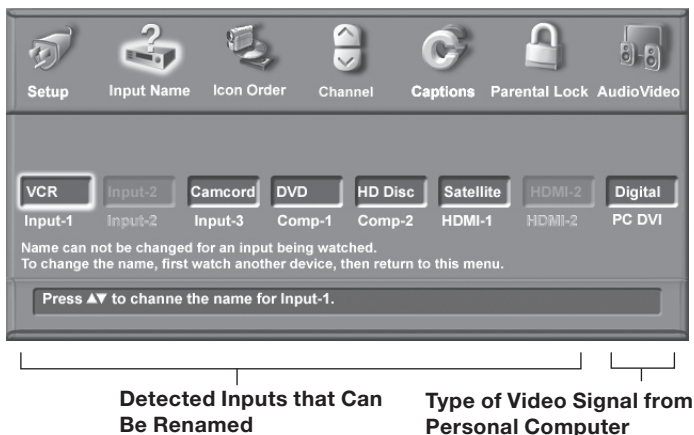

Figure 5. Input Name menu

To rename an input

1. If you are currently watching the input you wish to rename, change to another input. To do so, press **INPUT** to open the Input Selection menu, highlight a different input, and press **ENTER**.
2. With the Input Name menu displayed, press **◀▶** to move the highlight to the box for the input you wish to rename.
3. Press **▲▼** to select from the following list.

Cable Box	Game
Camcorder	HD Disc
DVD	Satellite
DVD2	VCR
DVR (digital video recorder, recordable DVD)	

Only one VCR label is available, so if you have a second VCR connected, leave the name as the default name.

IMPORTANT

It is possible to use the same name for more than one input. To avoid confusion, be sure to use different names for each input.

To Remove the Icon for an HDMI Device

When you disconnect an HDMI device, the icon remains in the Input Selection menu until you choose to remove it.

1. In the Input Name menu (see figure 5), highlight the box for the disconnected HDMI input.
2. Press **▲▼** to select Off.
3. Press **EXIT** to close all menus.

Icon Order Menu

The Icon Order menu allows you to rearrange the device icons that appear in the Input Selection menu. Change the sequence to put frequently used icons at the start of the list.

To change the icon order

1. Press **▲▼◀▶** to highlight the icon to be moved and then press **ENTER**.
2. Press **▲▼◀▶** to drag the icon to the desired position. Press **ENTER** to set the new position.

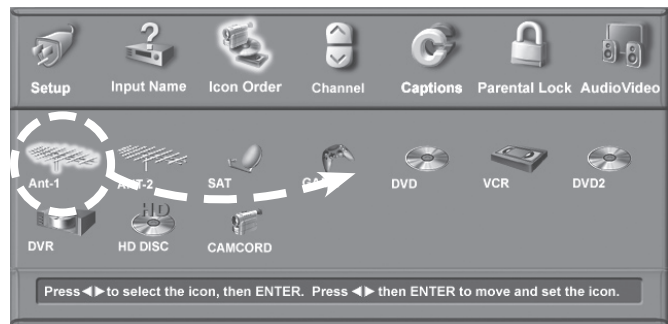

Figure 6. Icon Order menu

Channel Menu

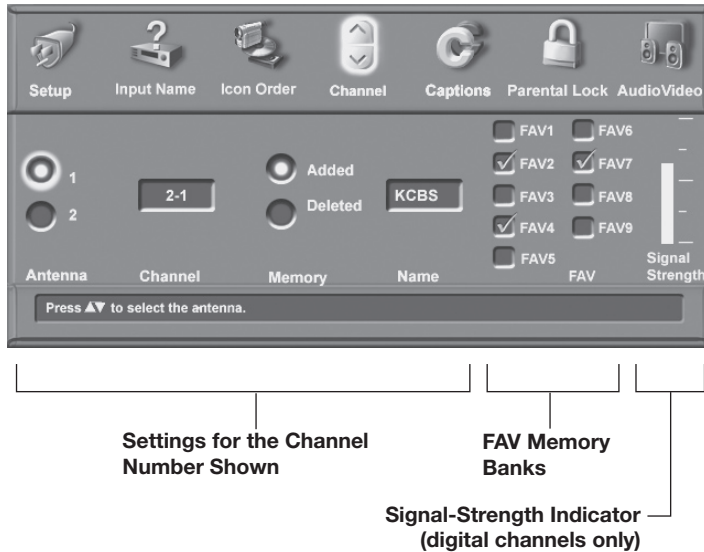

Figure 7. Channel menu

Antenna (Channel Menu)

Select either **1 (ANT 1 MAIN)** or **2 (ANT 2 AUX)** as the antenna source for the channels you wish to edit.

Channel (Channel Menu)

Select the affected channel number (shown in the Channel box) in any of three ways:

- Press **CH** \wedge/\vee to select from channels already in memory. If you also wish to tune to the channel, press **ENTER**.
- With the channel box highlighted, press $\blacktriangle/\blacktriangledown$ to move through all channel numbers, one at a time. If you also wish to tune to the channel, press **ENTER**.
- With the channel box highlighted, enter the number directly and press **ENTER**. Note that with this method, you must press **ENTER** for the screen to display settings for the selected channel.

Channel numbers can be one part, analog or digital (up to the number 16383), or two part for digital channels. For a two-part digital channel, press **CANCEL** on the remote to enter a separator after the first, second, or third number, depending on the broadcaster's channel information.

For digital channels, when the broadcaster has sent a virtual channel number, the virtual channel number is shown in the text box and the original physical digital channel is shown below on screen as a reference. One original channel number can be associated with several different virtual channels.

Memory (Channel Menu)

After the available channels have been memorized with **Memorize Channels** on the Setup menu, you can add weaker channels or delete unwanted channels using this option. For example, if you wish to see only digital channels listed, use this menu to delete analog channels from memory.

Press **CH** \wedge/\vee to review the channels in memory. Press $\blacktriangle/\blacktriangledown$ to select **Added** or **Deleted** for the channel shown in the **Channel** box.

Name

Analog channels from **ANT 1** and **ANT 2** can be named with up to four characters. The name you enter here will appear on the TV screen as part of the on-screen status display. Digital channels may already be named if the broadcaster sends the information.

1. Press a number key repeatedly to cycle through the characters associated with the key. You can also use $\blacktriangle/\blacktriangledown$ to change a highlighted character.
2. Press **ENTER** to set the letter and move to the next letter position. Press **CANCEL** to move back one position.

Signal Strength (Channel Menu)

Displays the approximate signal strength of the currently tuned digital channel. Use this indicator to help you adjust the antenna direction for best signal reception. The taller the bar, the stronger the signal. This indicator applies only to digital channels.

To view the effects of antenna adjustments on digital channels, tune to the digital channel you wish to measure while remaining in this menu. To tune to a channel, either:

- Highlight the channel box, press **CH** \wedge/\vee or $\blacktriangle/\blacktriangledown$ to display the desired channel number, and press **ENTER**.
- Enter the channel number on the remote control and press **ENTER**.

Terminology

Virtual Channel Number

A channel number used by a local broadcaster to help you identify their digital channel. Usually this is associated with their traditional analog channel number.

Physical Digital Channel Number

The channel number officially assigned to the actual broadcast frequency.

Channel Menu, continued

FAV (Channel Menu)

The FAV feature lets you store groups of favorite channels in up to nine different FAV memory banks. For example, each household member can store favorite channels in their own bank or you can store groups of channels by content, e.g., news, sports, children's programming, etc. You can store the same channel in multiple FAV banks.

Once you have added a channel to FAV memory, **FAV** and the memory bank number appear under the tuned channel number on the TV screen. You can access the FAV feature through the Channel menu or you can bypass the menu and use only the remote control.

FAV Setup Using the Channel Menu	
Initial Setup of a FAV Bank and Adding FAV Channels Using the Menu	<ol style="list-style-type: none"> 1. With the Channel menu displayed, select a channel using one of the methods described on the preceding page, for example, press CH \wedge/\vee for a memorized channel. 2. Highlight the desired bank (FAV1–FAV9) and press ENTER to check mark the selected FAV memory bank. The channel number displayed has now been added to the checked FAV bank. 3. With the FAV bank still highlighted, press CH \wedge/\vee to display the next channel you wish to add to the FAV bank. 4. Press ENTER to add a check mark next to the highlighted FAV bank. 5. Repeat steps 2–4 for additional channels and FAV banks.
Removing FAV Channels Using the Menu	<ol style="list-style-type: none"> 1. With the Channel menu displayed, press CH \wedge/\vee to display the memorized channel you wish to remove. 2. Highlight the desired FAV memory bank (FAV1–FAV9). 3. Press ENTER to remove the check mark.

Using FAV Channels	
Viewing FAV Banks	<ol style="list-style-type: none"> 1. Press the FAV key. Wait for the TV to tune to a channel in the current FAV bank. 2. Press the FAV key repeatedly to cycle through the channels available in the current FAV bank.
Changing FAV Banks	<ol style="list-style-type: none"> 1. Press the FAV key. Wait for the TV to tune to a channel in the current FAV bank. 2. When tuning is complete and while the TV status display is still visible on screen, press the number key for the desired bank. <p>Note: Wait for the channel change to finish before pressing the number key. Otherwise, the TV may ignore the FAV number.</p>
If No FAV Banks Are Set Up	The FAV key switches to the previously tuned channel; works like the QV key.

FAV Setup Using Only the Remote Control	
Adding FAV Channels	<ol style="list-style-type: none"> 1. While watching TV, tune to the channel you want to add to the current FAV memory bank. See the instructions above if you need to first change to a different FAV bank. 2. Press and hold the FAV button for about 2 seconds. When FAV and the memory bank number appear under the channel number, the channel has been successfully added.
Removing FAV Channels This procedure removes the channel only from the selected bank and leaves the other banks unchanged.	<ol style="list-style-type: none"> 1. While watching TV, press the FAV button 2. While the TV status display is still visible on screen, press the number key for the memory bank. 2. Press the FAV button repeatedly until you see the desired channel. 3. While the channel number and FAV indicator (with correct bank number) are still displayed on the screen, press CANCEL. You must press CANCEL before the On-Screen Display (OSD) disappears. When the FAV indicator disappears while the OSD is visible, the channel has been successfully removed.

Captions Menu

For analog channels, broadcasters can send either standard closed captions or text service. Standard closed captions follow the dialogue of the characters on screen and display in a small section of the screen. Text-service closed captions often contain information such as weather or news and cover a large portion of the screen.

For digital channels, broadcasters can send up to six different captioning selections or can send analog captions that are the same as those sent by the analog station. Each TV station may broadcast only one or two types of captions or none at all. The TV cannot decode closed captions received on component or HDMI inputs.

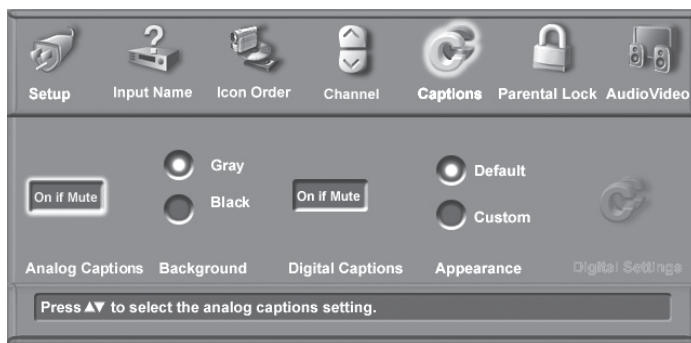

Figure 8. Captions menu

Analog Captions

The TV can display one of the following captions for analog sources:

- **CC1, CC2, CC3, or CC4:** standard closed-caption signals
- **Text1, Text2, Text3, or Text4:** Text-service signals
- **On if mute:** Closed captions appear when audio is muted. When selected, press MUTE on the TV remote control to turn on/off the standard closed-caption signal CC1.
- **Off:** No closed captions.

Background

To make the analog closed captions easier to read, you can choose to display the background color as either black or gray behind the text.

IMPORTANT

When analog text closed captioning is selected, a large black or gray box appears on your TV screen if no signal is broadcast.

Digital Captions

The following display options are available for digital sources:

- **Captions 1–6:** Sent by broadcaster.
- **On if Mute:** Closed captions are displayed when audio is muted. When selected, press MUTE on the TV remote control to turn captioning on/off (Caption 1).
- **Off:** No closed captions.

Note: For digital programs, if the broadcaster is sending only analog captions converted to digital format, then the analog caption settings apply.

Appearance

The closed-captions provider selects the default options when sending digital closed captions. Select **Custom** to override defaults and customize the appearance of closed captions. These settings do not apply to analog closed captioning converted to digital.

Digital Settings

The Digital Settings menu allows you to customize the appearance of the closed captions sent by the broadcaster. Digital settings do not apply to analog closed captions converted to digital.

To open the Digital Settings menu, select **Custom** for the **Appearance** option. Move the highlight to the **Digital Settings** icon and press ENTER.

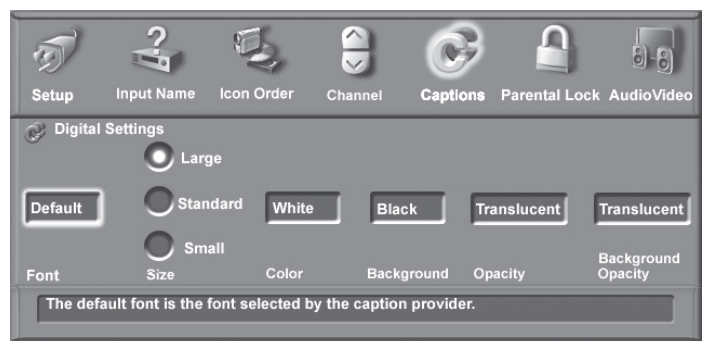

Figure 9. Closed Captions, Digital Settings sub-menu

Font

The available font options are as follows:

- **Default:** Selected by the closed-captions provider
- **Font 1:** Monospaced font with serifs
- **Font 2:** Proportionally spaced font with serifs
- **Font 3:** Monospaced font without serifs
- **Font 4:** Proportionally spaced without serifs

Captions Menu, continued

- **Font 5:** Casual font
- **Font 6:** Cursive font
- **Font 7:** Small capitals

Size

Select the desired font size. Large is the recommended font size.

Color

The available font colors are listed below. Text and background cannot be set to the same color.

White	Yellow
Black	Green
Magenta	Cyan
Red	Blue

Background

You can change the background color to make the digital closed captions easier to read. The available background colors are listed below. Text and background cannot be set to the same color.

White	Yellow
Black	Green
Magenta	Cyan
Red	Blue

Opacity (Font)

You can customize the visibility of your fonts using the following settings:

- **Translucent:** TV program is dimmed behind the text
- **Transparent:** Invisible text reveals the TV program behind.
- **Opaque:** Solid text blocks view of the TV program
- **Flashing:** Text flashes at intervals

Background Opacity

You can customize the background for digital captions using the following settings:

- **Translucent:** TV program is dimmed behind the background
- **Transparent:** No visible background
- **Opaque:** Solid background covers TV program
- **Flashing:** Background flashes at intervals

IMPORTANT

Mitsubishi recommends you use contrasting colors for captions and background.

Black translucent background combined with a white font makes an easy-to-read combination.

Use care when selecting custom colors. Your choice may affect the readability of captions.

IMPORTANT

The content of captions is determined by the broadcaster. If your captions show strange characters, misspellings, or odd grammar, it is not a malfunction of the TV.

Parental Lock Menu

The Parental Lock menu gives you control over three different types of parental controls. You must use a pass code to open this menu to enable/disable the lock options. The three parental controls available are:

- **Ratings (U.S. Ratings/Other Ratings)**
V-Chip technology lets you restrict access to programming based on program-rating signals sent by the broadcaster. For U.S. ratings, you can also set the time of day for these restrictions to be in effect.
- **Lock by Time**
Lets you restrict TV use by time of day.
- **Front Panel Lock**
Lets you disable the controls on the front of the TV. Use this option if there are small children near the TV who may be tempted to press the buttons.

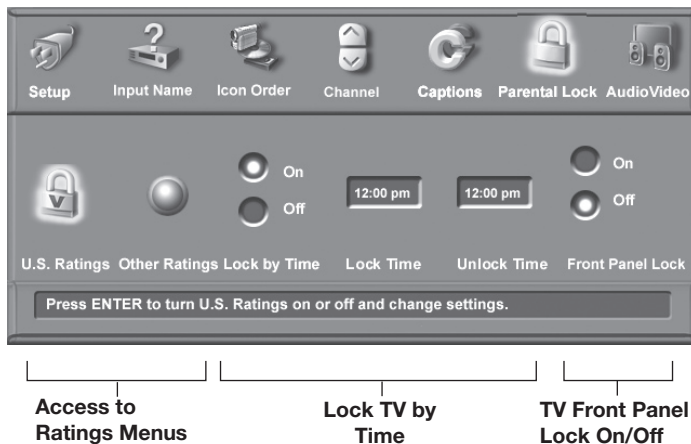

Figure 10. Parental Lock menu

Setting a Pass Code

You are prompted to enter a pass code whenever you select Parental Lock on the Main menu. To set a pass code for the first time:

1. Press **MENU**, highlight **Parental Lock**, then press **ENTER**. A screen prompting you for a pass code will display.
2. Input a four-digit pass code using the number keys on the remote control.
 - Press **CANCEL** to delete a number and move back one space.
 - Press **MENU** or **EXIT** to close the menu without setting a pass code.
3. Press **ENTER** to set the pass code just input.

To reset the pass code, see the procedure in Appendix A.

IMPORTANT

If you forget your four-digit pass code, see Appendix A.

Lock TV by Time and Front-Panel Lock

Lock by Time (Parental Lock Menu)

Lock by Time allows you to block all use of the TV during specified hours. During the lock time, you must use your pass code to view the TV. To lock the TV by time:

1. Press **▲ ▼** to select **On** or **Off** for **Lock by Time**.
2. Press **▶** to move to the **Lock Time** box.
 - a. With the hour number highlighted in yellow, press **▲ ▼** repeatedly to change the hour and associated **AM/PM indicator**. You can also just press and hold to change the hour.
 - b. Press **ENTER** to move the highlight to the minutes.
 - c. With the minutes number highlighted in yellow, press **▲ ▼** repeatedly to change the minutes. Just press and hold to move quickly through the numbers.
 - d. Press **▶** to move to the **Unlock Time** and set the time as described above.

NOTE: To make **Lock by Time** active 24 hours a day, set **Lock** and **Unlock** to the same time.

Front Panel Lock (Parental Lock Menu)

Front Panel Lock lets you disable controls on the front panel to prevent inadvertent changes to TV settings. Select **On** to disable the buttons and select **Off** to restore their operation.

To release the front button lock without using the remote control:

- When Energy Mode is set to **Fast Power On**, press and hold the **MENU** button on the front panel for over eight seconds. If the TV is on, a message will display confirming release of the Front Panel Lock.
- When Energy Mode is set to **Low Power**, press **POWER** on the front panel to turn on the TV. Press and hold the **MENU** button on the front panel for over eight seconds.

Rating Menus

The rating menus allow you to:

- Turn rating restrictions on or off
- Change the permitted rating level
- Set the time of day to enforce rating restrictions (U.S. ratings only)

The TV comes from the factory with pre-set U.S. V-Chip ratings and with the rating locks turned off. The pre-set ratings are TV rating TV-PG and movie rating PG. If you turn on V-Chip blocking, these presets allow only programs rated TV-PG/PG or lower until you change the rating level.

After changing the channel or device, there may be a delay of up to five seconds before the rating restrictions take effect.

Parental Lock Menu, continued

U.S. Ratings Menu

Use this menu to turn U.S. rating restrictions on or off and to change the permitted rating levels.

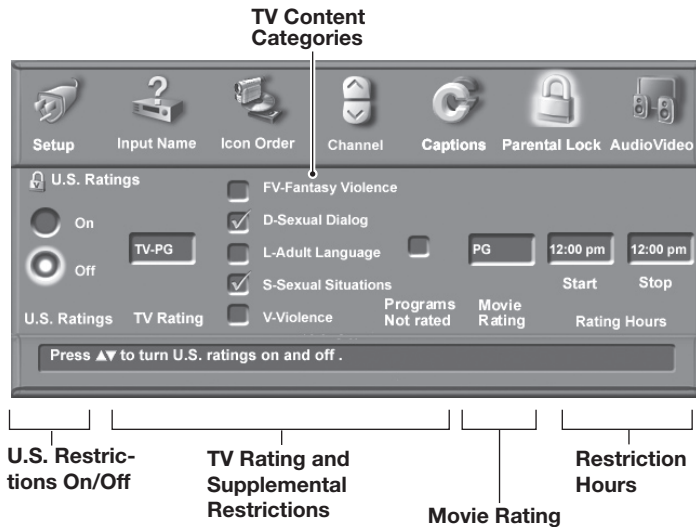



Figure 11. U.S. Ratings menu

1. Highlight the **U.S. Ratings** icon  on the Parental Lock menu (figure 10) and press **ENTER** to open the U.S. Ratings menu (figure 11).
2. Press **▲▼** to select **On** or **Off**.
3. If you selected **On**, press **▶** to move to the **TV Rating** box.
4. Press **▲▼** to select the TV rating level you want to allow.
5. Press **▶** to move to the TV content categories. This section allows you to specify content blocking in addition to that blocked by the TV rating. See the section on V-Chip ratings for an explanation of TV content categories.
 - Press **▲▼** to move the highlight among the categories.
 - Press **ENTER** to add a check mark to each TV content category you want to block.
6. Press **▶** to move to the **Programs Not Rated** box. Press **ENTER** to add or remove a check mark to allow or block programs that are not rated.

Note: Use care when choosing to block unrated programming. News programs and emergency bulletins carry the “None” or “NR” (Not Rated) V-Chip signal, and they are blocked with this option active.

7. Press **▶** to move to the **Movie Rating** box. Press **▲▼** to select the movie rating level you want to allow. Detailed information on rating guidelines follows this discussion of the Parental Lock menu.

8. To set the time of day for these restrictions to be in effect, press **▶** to move to the **Start** box. To make the rating restrictions active twenty-four hours a day, set **Start** and **Stop** to the same time. To set the time:
 - a. With the hour number highlighted in yellow, press **▲▼** repeatedly to change the hour. You can also just press and hold to change the hour.
 - b. Press **ENTER** to move the highlight to the minutes.
 - c. With the minutes number highlighted in yellow, press **▲▼** repeatedly to change the minutes. Just press and hold to move quickly through the numbers.
 - d. Repeat these steps for the **Stop** time.
9. Press **MENU** to return to the Parental Lock menu or press **EXIT** to close all menus.

Other Ratings Menu

This TV can recognize new rating systems that may come into effect in the future. The Other Ratings menu allows you to block digital programming based on such alternate rating systems. The alternate rating systems will apply to digital programming only.

Note: The **Other Ratings** button remains inaccessible until the TV receives signals for an alternate rating system.

The first time you tune to a channel broadcasting an alternate rating system, the TV defaults to the most restrictive setting. Use this menu to change the allowed rating if you are unable to watch a program broadcast with an alternate system.



Figure 12. The Other Ratings menu is available only if the TV receives broadcast signals carrying an alternate rating system.

IMPORTANT

New rating systems recognizable by the TV may be new U.S.-based systems not included in the original V-Chip rating system. The use of “Canadian” in the sample screen is just one possibility.

Parental Lock Menu, continued

1. Highlight the button labelled **Other Ratings** on the Parental Lock menu (figure 10) and press **ENTER** to open the Other Ratings menu (figure 12).
2. Press **▲ ▼** to select **On** or **Off**.
3. If you selected **On**, press **▶** to move to the **Rating Group** box.

Note that you can change settings only for the rating system available on the currently tuned channel. In the figure above, for example, the Canadian rating system is in effect. To change settings at a later time for the Canadian rating system, you must again tune to a channel broadcasting the Canadian system.

4. Press **▲ ▼** to select from the subgroups available for the rating system—**English** or **French** in this example.
5. Press **▶** to move to the **Rating** box.
6. Press **▲ ▼** to select the program rating level you want to block.
7. Press **ENTER** to add a check mark to indicate blocking is in effect for the rating. When a rating shows a check mark, press **ENTER** to remove the check mark and allow programs with this rating.
8. Repeat steps 3 through 7 for each additional rating system you would like to set up.
9. Press **MENU** to return to the Parental Lock menu or press **EXIT** to close all menus.

Bypassing the Ratings Lock and Lock by Time

If you try to watch blocked programming, a notice appears prompting you for a pass code. To use the TV:

- Input your four-digit pass code and press **ENTER**.
- Change to a channel airing an allowed program or change to another device.

If you try to use the TV when it is locked by time, a similar screen appears, prompting you for your pass code.

To reactivate the rating lock or TV Lock by Time after using the pass code, power the TV off and then on.

V-Chip Signal Information

When provided by the broadcaster or program source, V-Chip ratings let you control the types of programming that can be viewed on the TV. When V-Chip ratings are supplied, they are displayed when you change the channel or press **INFO** on the remote control.

TV Ratings

TV ratings apply to TV programs and made-for-TV movies. You can apply supplemental blocking to TV ratings based on the TV content categories described below. TV ratings are:

- TV-Y** Youth. For children under the age of 7.
TV-Y7 Youth 7 and older.
TV-G General Audience. For the entire family to view.
TV-PG Parental Guidance. Parental Guidance is recommended; may not be suitable for some children.
TV-14 Adolescent 14 and older. Not recommended for children under the age of 14.
TV-MA Mature Audience. For adults only.

TV Content Categories

Used in association with the TV ratings above, TV content categories allow you to apply supplemental blocking. Apply supplemental blocking using the U.S. Ratings menu.

- FV Fantasy Violence.** Applies to TV-Y7 only.
D Sexual Dialog. Applies in different degrees to TV-PG and TV-14.
L Adult Language. Applies in differing degrees to TV-PG, TV-14, and TV-MA.
S Sexual Situations. Applies in differing degrees to TV-PG, TV-14, and TV-MA
V Violence (graphic or realistic). Applies in differing degrees to TV-PG, TV-14, and TV-MA.

TV Rating	FV	D	L	S	V
TV-Y					
TV-Y7	X	Not Applicable			
TV-PG	Not Applicable	X	X	X	X
TV-14	Not Applicable	X	X	X	X
TV-MA			X	X	X

TV content categories. Boxes marked with an "X" indicate supplemental blocking you can apply to each rating level.

The TV rating you select is for the least-restrictive program level allowed. For example, if you select TV-PG, programs rated TV-Y, TV-Y7, and TV-PG can be viewed, but programs rated TV-14 and TV-MA are blocked.

When you select a TV content category to block, all TV programs with the same content category listing are blocked. For example, if you select to block V (Violence) at the TV-14 level, any programs with the V category listing rated TV-PG are also blocked.

V-CHIP EXCEPTIONS

- V-Chip blocking is ineffective for programs viewed on devices connected to component or HDMI inputs. Many of these devices, however, have their own parental-control systems.
- Videotapes, laser discs, and DVDs may not contain V-Chip rating signals. V-Chip cannot block playback of recordings without V-Chip rating signals.
- Broadcasters are not currently required to include V-Chip rating signals. V-Chip cannot block programming broadcast without the V-Chip rating signal.

Movie Ratings

Movie ratings are the MPAA ratings used for theater-released and direct-to-video movies. Movie ratings are:

- G General Audience.** Designed for the entire family to view.
PG Parental Guidance. Parental Guidance is recommended, may not be suitable for some children.
PG-13 Parental Guidance, 13 and Older. Not recommended for children under the age of 13.
R Restricted. Restricted in theaters to 17 years old and older unless accompanied by an adult.
NC-17 No Children 17 or Under. Restricted in theaters to 18 years old and older.
X Adult. Designed for and restricted in theaters to adult audiences only.

The movie rating you select is for the least-restrictive program level that can be viewed. For example, if you select the PG-13 rating, movies rated G, PG and PG-13 can be watched, but movies rated R, NC-17, and X are blocked.

Programs Not Rated: This refers to programs that carry no rating, such as news, sports, weather, emergency bulletins, or movies prior to or without MPAA ratings. This does not include programs without V-Chip signals.

IMPORTANT

If you enable blocking with the Programs Not Rated option, you may block news or emergency bulletins carrying the "None" or "NR" Not Rated V-Chip rating. Use care when blocking programming that is not rated.

Audio/Video Menu

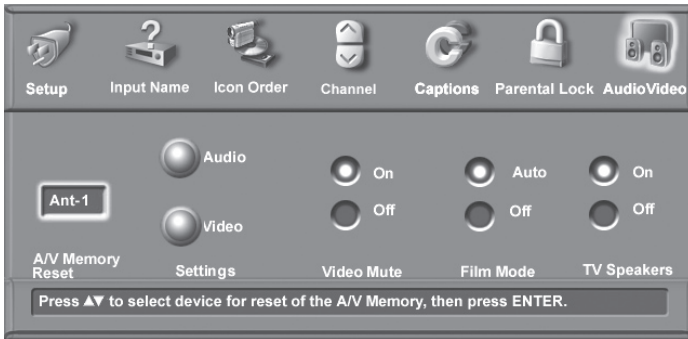

Figure 13. Audio/Video Menu

A/V Memory Reset

A/V Memory Reset allows you to reset a specific input's A/V settings to the original factory settings. Highlight the box and press **▲▼** to select the input name. Next press **ENTER**.

The audio settings of **Balance**, **Listen to**, and **Language** are general TV settings unaffected by A/V Memory Reset.

To reset all A/V settings at once, including the three general settings, perform an A/V Reset by pressing the front-panel buttons **GUIDE** and **FORMAT** simultaneously.

Settings (Audio and Video)

Each input or device has its own A/V memory. Press **▲▼** to select the input or device in the **A/V Memory Reset** box, then select **Audio** or **Video** to adjust individual settings. Press **ENTER** to close the menu and display the individual settings.

Use **▲▼** to cycle through the individual settings. Use **◀▶** to change the setting values. Press **EXIT** to return to normal TV viewing. For descriptions of the individual A/V settings, see the following pages.

Video Mute

The default is **On**, which displays a blue background when no signal is being received on the **INPUT**, **COMPONENT**, or **HDMI** jacks.

Film Mode (480i signals only)

Auto is the default setting. With **Auto** selected, the TV automatically detects and applies film-decoding correction for images that originated on 24-frame-per-second film cameras and were converted to 30-frame-per-second video for broadcast (3:2 pulldown conversion). Try the **Off** setting if the TV adds noticeable jagged edges to the images.

When the original video was filmed on 30-frame-per-second cameras, the **Auto** setting automatically applies video decoding, the same as used with the **Off** setting.

Film Mode is not effective for high-definition signals.

TV Speakers

This selection turns the TV's internal speakers on or off. Select **Off** when sending the sound through a separate stereo system or surround sound A/V receiver.

Note: To prevent damage from a sudden increase in volume, turn the TV volume down low before changing this option to **On**.

Audio/Video Settings and the Remote Control

To adjust individual audio or video settings directly with the remote control:

1. Press **AUDIO** or **VIDEO** repeatedly to cycle through the available settings.
2. Press **◀▶** to adjust the setting. The setting display will disappear after five seconds of inactivity.

Audio/Video Menu, continued

Audio Settings

Analog and Digital Audio Settings

Enter the audio adjustment mode using either the Audio/Video menu or the **AUDIO** key. Press **AUDIO** repeatedly until you highlight the desired audio control, then use ◀ ▶ to change the setting, which has a corresponding numeric value shown on screen. Values can be adjusted from 0 to 63, with 31 as the midpoint.

Note: The effects of the audio settings of **Bass**, **Treble**, **Balance**, and **Surround** affect only the sound heard through the TV speakers.

◇ Bass

Enhances or reduces low-pitched sound.

◇ Treble

Enhances or reduces high-pitched sound.

◇ Balance

Adjusts the level of sound between the left and right TV speakers.

◇ Surround

Creates simulated stereo and surround effects through the TV speakers. Your choices are:

- **Off:** No surround effects (default).
- **Simulated Stereo:** The TV creates a simulated stereo effect when watching a non-stereo program.
- **Surround Sound:** The TV creates a simulated surround effect when watching a stereo program.

◇ Level Sound

When on, automatically equalizes the volume level when there are significant sound-level differences between program segments, such as between regular programming and commercials.

- To receive the best fidelity with music programs, change this setting to **Off**.
- When connecting to an A/V receiver, set **Level Sound** to **Off** and turn off the TV speakers to send full dynamics to the A/V receiver.

Analog-Only Audio Settings

You can set analog-only audio settings while viewing either analog or digital sources, but the settings affect only broadcast analog content.

◇ Listen To

Determines how your TV receives a broadcast audio signal and plays the sound you hear.

Your choices are:

- **Stereo:** Default setting. The TV plays stereo broadcasts in stereo and mono broadcasts in mono. The word **Stereo** is displayed when you tune to a channel broadcasting in stereo.
- **SAP** (Second Audio Program): Additional monaural sound track that you cannot hear during normal TV viewing. The SAP signal might be related to the program you are watching, (such as a sound track in a foreign language), or it might be unrelated (such as a weather report). If an SAP signal is broadcast, the letters **SAP** are displayed when you tune to the channel.
- **Mono:** Reduces background noise. Use when receiving a weak stereo audio signal. All audio is played mono with this setting.

Listen To is not available for digital channels, 1394 devices or devices connected to the **INPUT**, **COMPONENT** and **HDMI** jacks.

Digital-Only Audio Settings

You can set digital-only audio settings while viewing either analog or digital sources, but the settings affect only broadcast digital content.

◇ Language

Determines what possible language you can hear. Your choices are:

English	Portuguese
French	Spanish
German	Other
Italian	

IEEE 1394 Amplifier Settings

Available settings for some MPEG2 amplifiers:

◇ Balance

Adjusts the level of sound between the left and right speakers. The slider range is 0–254, with 127 as the midpoint.

◇ Loudness

When on, makes the audio level more uniform.

◇ Preset

Select the mode that matches the audio source. Your choices are:

Off	Classical Music
Jazz	Movie
Rock	Speech

◇ Equalizer

Equalizes the sound.

Audio/Video Menu, continued

Video Settings

Enter the video adjustment mode using either the Audio/Video menu or the **VIDEO** key. Press the **VIDEO** key repeatedly to cycle through the video options to the one you want to change. Use ◀ ▶ to change settings.

Note: A slider displays on screen for some settings. When the slider is displayed, it represents numeric values, with 63 as the maximum, 31 as the mid-point, and 0 as the minimum.

◇ **(Power) Swivel:** For LT-37131 model only. Swivels the TV up to thirty degrees left or right. When a menu or slider is displayed, Power Swivel can not be accessed using ◀ ▶.

Note: Power Swivel is not available while the TV is in Split Screen mode.

◇ **Picture Mode:** Set the Picture Mode first before adjusting other settings, as each Picture Mode stores its own values for Contrast, Brightness, and Color Temperature. Picture Modes allow you to optimize the image for different lighting conditions. The Picture Modes are:

- **Bright:** Suited for most daytime viewing.
- **Natural:** Suited for most nighttime viewing.
- **Brilliant:** The default setting. For use under strong light.

◇ **Contrast** (Bright/Natural/Brilliant): Provides a slider to adjust the white-to-black level. Low contrast shows a variety of shades in darker images, while high contrast shows darker images more uniformly black and makes colors appear more vibrant. In most home lighting situations, a medium contrast looks best. High contrast is good for brightly lit environments.

◇ **Brightness** (Bright/Natural/Brilliant): Provides a slider to adjust the overall brightness of the picture.

◇ **Color:** Provides a slider to adjust color intensity.

◇ **Tint:** Provides a slider to adjust the red-to-green ratio.

◇ **Sharpness:** Provides a slider to adjust the detail and clarity.

◇ **Color Temperature** (Bright/Natural/Brilliant): Allows you to adjust how white is displayed.

- **Low:** White images have a warm cast. This adjustment is an average and can vary due to ambient room lighting, video scene brightness, and the TV's age. Natural/Color Temp at the low setting displays video at the 6500K industry standard for NTSC pictures.
- **High:** White images have a cool cast. This setting may provide the most realistic picture under bright lighting.

◇ **PerfectColor™:** Lets you adjust the intensity of any or all of six colors (Magenta, Red, Yellow, Green, Cyan and Blue) to create color balance for the current image source. PerfectColor settings are memorized for each TV input or device. Select the **PerfectColor** option and press **ENTER** to open the adjustment screen.

Individual sliders for each color are displayed.

Highlighted text shows which slider you are adjusting. Press **CANCEL** while in the PerfectColor screen to reset all colors to the default settings.

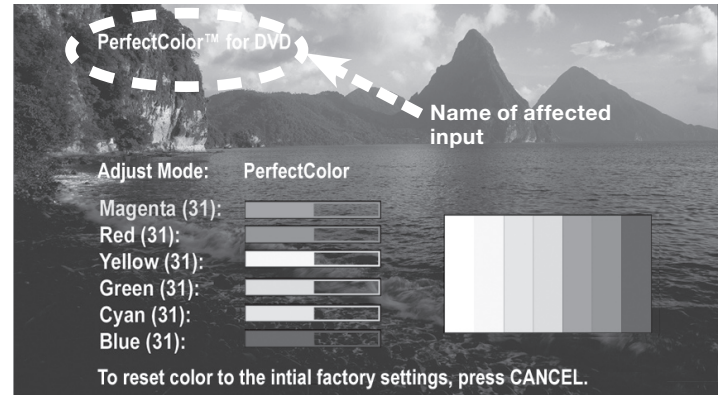

Figure 14. Set PerfectColor adjustments independently for each TV input.

◇ **Video Noise:** Reduces minor noise (graininess) in the picture. Use the **Low** setting with good-quality signals. Use **Medium** or **High** with poor-quality signals. Turn off to leave the picture unaltered.

◇ **Back Light:** Lets you adjust the TV's back light peak brightness settings for optimal viewing in different room lighting conditions. A higher setting looks more vibrant in brightly lit rooms; a lower setting may look more natural when viewing in a darkened room.

Personal Computer Video Settings

Video settings available for images from a personal computer are:

◇ **Contrast**

◇ **Brightness**

◇ **PerfectColor™.** The adjustment screen displays without the vertical color bars when used for a computer image,

◇ **Auto Position:** Press **ENTER** to automatically center the position of PC video.

◇ **HorizPosition (Horizontal Position):** Manually adjust the horizontal position of PC video. This selection overrides the Auto Position selection.

◇ **VertPosition (Vertical Position):** Manually adjust the vertical position of PC video. This selection overrides the Auto Position selection.

◇ **Fine Detail:** Manually adjust the picture quality of PC video, analog signals only. This selection overrides the Auto Position selection.

Operating Other Devices with the Remote Control

Functions Available for Other A/V Devices.	64
Programming the Remote Control	65
Programming Codes.	66

Functions Available for Other A/V Devices

The TV's remote control can be programmed to operate other types and brands of A/V products. To use the remote when programmed, set the slide switch to the position labelled for the product type. The functions performed in each switch position can vary depending on the product. Not all functions work for all models. The most common functions available are listed on this page.

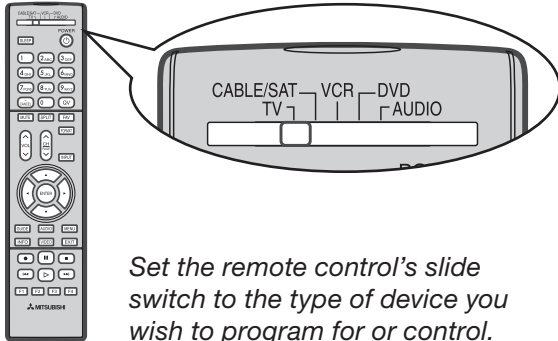

Set the remote control's slide switch to the type of device you wish to program for or control.

IMPORTANT

Some manufacturers may change their products or they may use more than one remote control system. The TV's remote control may be unable to operate your A/V equipment in these cases.

VCRs and DVRs

- | | |
|--|---|
| <ul style="list-style-type: none"> • CH \wedge/\vee • POWER • SLEEP • $\blacktriangleright\blacktriangleright$ (FAST FORWARD) • \parallel (PAUSE) • \blacktriangleright (PLAY) | <ul style="list-style-type: none"> • \bullet (RECORD) • $\blacktriangleleft\blacktriangleleft$ (REVERSE) • \blacksquare (STOP) • GUIDE (on DVRs) • MENU (on DVRs) • 0-9 Number Buttons |
|--|---|

Mitsubishi VCRs are compatible with some additional buttons.

Cable Boxes and Satellite Receivers

- | | |
|---|---|
| <ul style="list-style-type: none"> • AUDIO (page up) • CANCEL (on some models) • CH \wedge/\vee • ENTER (on some models) • GUIDE (on some models) • POWER • $\blacktriangle\blacktriangledown\blacktriangleleft\blacktriangleright$ (on some models) • VIDEO (page down) • QV (ENTER; for channels on some models) | <ul style="list-style-type: none"> • 0-9 Number Buttons (on some models) • F1-F4 (A, B, C, D keys on some models) <p>The record/playback keys (on some models):</p> <ul style="list-style-type: none"> • $\blacktriangleright\blacktriangleright$ (FAST FORWARD) • \parallel (PAUSE) • \blacktriangleright (PLAY) • \bullet (RECORD) • $\blacktriangleleft\blacktriangleleft$ (REVERSE) • \blacksquare (STOP) |
|---|---|

A/V Receivers

- | | |
|--|---|
| <ul style="list-style-type: none"> • MUTE • POWER • SLEEP • VOLUME • 0-9 Number Buttons | <ul style="list-style-type: none"> • Direct Input Selection buttons: numbers, FAV and QV (on some Mitsubishi models) |
|--|---|

CD Players

(not all functions for all models)

- | | |
|--|---|
| <ul style="list-style-type: none"> • SLEEP • $\blacktriangleright\blacktriangleright$ (FAST FORWARD) • \parallel (PAUSE) • \blacktriangleright (PLAY) | <ul style="list-style-type: none"> • $\blacktriangleleft\blacktriangleleft$ (REVERSE) • \blacksquare (STOP) • 0-9 Number Buttons |
|--|---|

DVD and Laser Disc Players

(not all functions for all models)

- | | |
|---|--|
| <ul style="list-style-type: none"> • CANCEL (on some models) • CH \wedge/\vee (on some models) • ENTER • MENU • POWER • SLEEP • $\blacktriangle\blacktriangledown\blacktriangleleft\blacktriangleright$ (on some models) | <ul style="list-style-type: none"> • $\blacktriangleright\blacktriangleright$ (FAST FORWARD) • \parallel (PAUSE) • \blacktriangleright (PLAY) • \bullet (RECORD) • $\blacktriangleleft\blacktriangleleft$ (REVERSE) • \blacksquare (STOP) • 0-9 Number Buttons (on some models) |
|---|--|

Programming the Remote Control

Method 1: Code Entry

1. Move the slide switch at the top of the remote to the position for the product you want to control. Refer to the table below. Only one of each device type can be controlled in each slide-switch position.

Switch Position	Affected Device
CABLE/SAT	Cable Box DTV Receiver Satellite Receiver
VCR	VCR DVR Laser Disc Player DVD Player/Recorder
DVD	DVD Player/Recorder DVR Laser Disc Player VCR
AUDIO	A/V Receiver Audio Amplifier CD Player

2. Press and hold **POWER** on the remote control for several seconds until the button blinks twice and goes off.
3. Release the **POWER** button.
4. Enter the first five-digit code listed for your equipment.
 - The **POWER** button blinks twice when you start to enter the code and then once for each additional keypress.
 - The **POWER** button blinks twice when you finish entering a valid code.
 - Move the slide switch to another position if you need to start over or wish to exit programming mode.
5. Point the remote control at the equipment and press **POWER**. If the product has no power on/off function, press a different key, such as **▶ (PLAY)**, **■ (STOP)**, **VOL ▲**, or **MUTE**.
 - If the equipment responds, the remote control is properly programmed to operate the equipment.
 - If the equipment does not respond, repeat steps 2–4 with the next five-digit code listed for your equipment.

IMPORTANT

You may need to reprogram the remote control after changing the batteries.

6. Once you have found the correct code, write it in the space below for future reference.

Switch Position	Device Type	Code
CABLE/SAT		
VCR		
DVD		
AUDIO		

Method 2: Code Search

In this method of programming, you step through the remote control's internal code library to find the correct code for your A/V product.

1. Move the slide switch at the top of the remote control to the correct position for the product. See the table under "Method 1."
2. Press and hold **POWER** on the remote control for several seconds until the button blinks twice and goes off.
3. Press keys **9 9 1**
4. Press the number 1, 2, or 3 depending on the slide-switch position and the table below.

Switch Position	Number
CABLE/SAT	1
DVD, VCR	2
AUDIO	3

5. Press **CH ▲** and **POWER** repeatedly until the product responds by powering on or off. You can press **CH ▼** to move backward through the code library if needed.

NOTE: If the product has no power on/off function, check for a response using a different function. Press **▶ (PLAY)**, **■ (STOP)**, **VOL ▲**, or **MUTE** and then repeatedly press **CH ▲/▼** to check for a response.

6. When the product responds, press **ENTER** to set the code.

Code Verification

To determine the code programmed for any position of the slide switch:

1. Move the slide switch to the position you wish to verify.
2. Press and hold **POWER** on the remote control for several seconds until the button blinks twice and goes off.
3. Press keys **9 9 0**
4. Press 1 and count the blinks of the power button. Write down the number of blinks as the first digit of the code.
5. Repeat step 4 for the second, third, fourth, and fifth digits of the code.

Audio Lock: Universal A/V Receiver Control

With Audio Lock active, the remote control operates the volume and mute functions of the A/V receiver in all positions of the slide switch. Activate Audio Lock if you normally use an A/V receiver with your TV and other A/V equipment.

1. Program the **AUDIO** position for your A/V receiver as described earlier in this section.
2. Move the slide switch to the **AUDIO** position.
3. Press and hold **POWER** on the remote control for several seconds until the button blinks twice and goes off.
4. Press keys **9 9 3 ENTER**
The **POWER** button will blink twice to indicate Audio Lock is active.

To Reset the Remote Control to Operate Volume and Mute for the TV Speakers

1. Press and hold **POWER** for several seconds until the button blinks twice and goes off.
2. Press keys **9 9 3 VOL ^**.
The **POWER** button will blink four times to indicate Audio Lock has cleared.

Programming Codes

Audio Amplifiers	
Brand	Code
Acurus	30765
Adcom	31100, 30577
Altec Lansing	31742
Aragon	30765
Bel Canto Design	31583
Bose	30674
Carver	30892
Classe	31462, 31461
Curtis Mathes	30300
Durabrand	31561
Elan	30647
GE	30078
Harman/Kardon	30892
JVC	30331
Klipsch	30765
Left Coast	30892
Lenox	31561
Lexicon	31802
Logitech	31408
Marantz	30892
Mark Levinson	31483
McIntosh	30251
Mondial	30765
Optimus	30823, 30395, 30300
Philips	30892
Pioneer	30823, 30300, 30257, 30013
Polk Audio	30892
RCA	30823, 30300
Realistic	30395
Sharp	30226
Sony	30815
Soundesign	30078
Technics	30374, 30372
Toshiba	30353
Victor	30331
Wards	30078, 30013
Yamaha	30354

A/V Receivers	
Brand	Code
ADC	30531
Adcom	31617, 31616
Aiwa	31641, 31405, 31388, 31347, 31321, 31243, 30189, 30121
Akai	31255
Alco	31390
AMC	31077
Amplifier Technologies	31584
Anam	31609, 31074
Apex Digital	31774, 31430, 31257
Arcam	31189
Atlantic Technology	31487
Audiophase	31387

Programming Codes, continued

A/V Receivers	
Brand	Code
Audiotronic	31189
Audiovox	31627, 31390
B & K	30840, 30820, 30701
Bel Canto Design	31584
BK	30702
Bose	31253, 31229, 30639
Brix	31602
Cambridge Soundworks	31477
Capetronic	30531
Carver	31289, 31189, 30189, 30121
Coby	31263
Curtis	30797
Delphi	31414
Denon	31360, 31311, 31142, 30121,
Fisher	31801, 31409
Fosgate	31487
Glory Horse	31263
GPX	31299
Harman/Kardon	31306, 31304, 31289, 30891, 30189, 30110
Hitachi	31801, 31273
Integra	31320, 31298, 30135
JBL	31306, 30110
JVC	31811, 31643, 31495, 31374, 31282, 31263, 31058
Kenwood	31570, 31569, 31313
KLH	31428, 31390
Koss	31497, 31366
Linn	30189
Liquid Video	31497
Magnavox	31514, 31269, 31189, 30531, 30189
Marantz	31289, 31269, 31189, 30200, 30189,
McIntosh	31289
Micromega	31189
Mitsubishi	31957, 31922, 31921, 31920, 31393, 30176
Myryad	31189
Nakamichi	31555, 31313, 30097
Onkyo	31320, 31298, 30842, 30135
Optimus	31074, 31023, 30849, 30797, 30670, 30531
Oritron	31497, 31366
Outlaw	31487
Panasonic	31764, 31763, 31633, 31548, 31518, 31509, 31363, 31350, 31316, 31308, 31288, 30309
Philips	31368, 31365, 31283, 31269, 31268, 31266, 31189, 30189
Pioneer	31384, 31343, 31023, 30630, 30531, 30150, 30014
Polk Audio	31414, 31289, 30189
Proscan	31254
RadioShack	31263

A/V Receivers	
Brand	Code
RCA	31609, 31511, 31390, 31254, 31074, 31023, 30531
Rio	31869
Samsung	31500, 31295
Sansui	31189, 30189
Sanyo	31801
Sharp	31386, 31361
Sharper Image	31416, 31411, 31410, 31409, 31385, 31263, 30797
Sherwood	31077
Sirius	31811, 31627, 31602
Sonic Blue	31869
Sony	31858, 31759, 31758, 31658, 31622, 31558, 31529, 31503, 31458, 31441, 31406, 31382, 31371, 31367, 31258, 31131, 31058
Soundesign	30670
Stereophonics	31023
Sunfire	31313
Sylvania	30797
Teac	31528, 31390, 31267, 31074
Technics	31633, 31518, 31308, 30309
Thorens	31189
Toshiba	30135
Venturer	31390, 30849
Wards	30189, 30014
XM	31414, 31406
Yamaha	31375, 31331, 31276, 31176, 30176

CD Players	
Brand	Code
Aiwa	30157
Akai	30156
Arcam	30157
Audio-Technica	30170
Burmester	30420
California Audio Labs	30303, 30029
Carver	30437, 30299, 30179, 30157
Classic	31297
Denon	30873, 30034, 30003
DKK	30000
DMX Electronics	30157
Emerson	30305
Fisher	31325, 30179, 30174
Garrard	30420, 30393
Gemini	30625
Genexxa	30305, 30032
GPX	31296
Harman/Kardon	31202, 30173, 30157, 30083
Hitachi	30032
Integra	30101

Programming Codes, continued

CD Players	
Brand	Code
JVC	31294, 30072
Kenwood	30826, 30681, 30626, 30190, 30037, 30028,
KLH	31711, 31373, 31372, 31318
Koss	31317
Krell	30157
LG	31208
Linn	30157
LXI	30305
Magnavox	30305, 30157, 30038
Marantz	30626, 30435, 30180, 30157, 30038, 30029
Mark Levinson	31484
McIntosh	30660, 30290, 30256
MCS	30029
MGA	30083
Miro	30000
Mission	30157
Mitsubishi	30098, 30083
MTC	30625, 30420
NAD	30299, 30019
Nikko	30625, 30174, 30170
NSM	30157
Onkyo	31327, 30868, 30102, 30101
Optimus	31075, 31063, 30468, 30437, 30420, 30305, 30179, 30145, 30087, 30037, 30032, 30000
Panasonic	30752, 30388, 30303, 30029
Parasound	30420
Philips	30626, 30274, 30157
Pioneer	31087, 31063, 31062, 30551, 30468, 30305, 30032
Polk Audio	30157
Proceed	30420
Proton	30157
QED	30157
Quad	30157
Quasar	30029
RadioShack	31075
RCA	31062, 30764, 30468, 30420, 30305, 30179, 30053, 30032
Realistic	30420, 30180, 30179
Rotel	30420, 30157
SAE	30157
Sansui	30305, 30157
Sanyo	30179, 30087
Scott	30305
Sears	30305
Sharp	30861, 30265, 30180, 30037
Sherwood	31067, 30180
Sonic Frontiers	30157
Sony	31364, 30673, 30605, 30604, 30490, 30185, 30100, 30000
Soundesign	30145
Sugden	30157

CD Players	
Brand	Code
Symphonic	30305
TAG McLaren	30157
Tascam	30420
TDK	31208
Teac	30420, 30393, 30378, 30180, 30174
Technics	30303, 30029
Tivoli Audio	31553
Toshiba	30299, 30019
Victor	30072
Wards	30157, 30053
Yamaha	31292, 30888, 30490, 30261, 30187, 30170, 30036,
YBA	30625
Yorx	30461

Cable Boxes	
Brand	Code
ABC	10017, 10014, 10013, 10011, 10008, 10007, 10003, 10001
Allegro	10315, 10153
Americast	10899
Antronix	10207, 10022
Archer	10797, 10207, 10153, 10022
BBT	10267
Belcor	10056
Bell & Howell	10014
Bell South	10899
Cable Star	10056
Cabletenna	10022
Cableview	10022
Century	10153
Citizen	10315, 10153
Clearmaster	10883
ClearMax	10883
Colour Voice	10031, 10025
Comtronics	10040
Contec	10019
Coolmax	10883
Digeo	11187
Digi	10637
Director	10476
Dumont	10637
Eastern	10002
Emerson	10797
Everquest	10040, 10015
Focus	10400
Garrard	10153
GC Electronics	10207, 10056
Gemini	10797, 10015
General Instrument	10810, 10476, 10276, 10011, 10003
GoldStar	10144, 10040
Goodmind	10797

Programming Codes, continued

Cable Boxes	
Brand	Code
Hamlin	10273, 10259, 10034, 10020, 10009
Hitachi	10011
Hytex	10007
i3 Micro	11602
Jasco	10315, 10153, 10015
Jerrold	10810, 10476, 10276, 10024, 10015, 10014, 10012, 10011, 10003
Linsay	10440
Magnavox	10027
Memorex	10000
Motorola	11376, 11254, 11187, 11106, 10810, 10476, 10276, 10014
Movie Time	10156, 10063
Multitech	10883
Myrio	11602
Novaplex	10618
NSC	10156, 10063
Oak	10019, 10007
Optimus	10021
Pace	11877, 10237, 10008
Panasonic	10107, 10021, 10000
Panther	10637
Paragon	10000
Philips	11305, 10317, 10153, 10031, 10027, 10025
Pioneer	11877, 10877, 10533, 10144, 10023
Popular Mechanics	10400
Pulsar	10000
Quasar	10000
RadioShack	10883, 10797, 10315, 10015
RCA	11256, 10021
Realistic	10207
Recoton	10400
Regal	10279, 10273, 10259, 10020
Regency	10002
Rembrandt	10011
Runco	10000
Samsung	10144, 10040
Scientific Atlanta	11877, 10877, 10477, 10017, 10008,
Seam	10510
Sejin	11602
Signal	10040, 10015
Signature	10011
SL Marx	10040
Sony	11006
Sprucer	10021
Starcom	10015, 10003
Stargate	10797, 10040, 10015
Starquest	10015
StarSight	10422
Supercable	10276
Supermax	10883

Cable Boxes	
Brand	Code
Sylvania	10001
Tandy	10258
TeleCaption	10221
Televue	10040
Texscan	10001
TFC	10310
Thomson	11256
Timeless	10418, 10040
Tocom	10013, 10012
Torx	10003
Toshiba	10000
Tristar	10883
Tusa	10015
TV86	10063
Unika	10207, 10153, 10022
United Artists	10007
Universal	10207, 10191, 10153, 10056, 10022,
V2	10883
Viewmaster	10883
Viewstar	10258, 10063, 10027
Vision	10883
Vortex View	10883
Zenith	10899, 10525, 10054, 10000
Zentek	10400

DVD Players/Recorders	
Brand	Code
Adcom	21094
Aiwa	20641
Akai	21089, 20770
Alco	20790
Allegro	20869
Amphion Media Works	20872
AMW	20872
Apex Digital	21100, 21061, 21056, 21020, 21004, 20797, 20796, 20794, 20755, 20717, 20672
Aspire Digital	21407, 21168
Audiologic	20736
Audiovox	21072, 21041, 20790
Axion	21072
B & K	20662, 20655
Bel Canto Design	21571
Blaupunkt	20717
Blue Parade	20571
Broksonic	20695
California Audio Labs	20490
CAVS	21057
Cinea	20831
CineVision	20876, 20869, 20833
Citizen	21277
Coby	21351, 21177, 21165, 21107, 21086, 20852, 20778
Craig	20831

Programming Codes, continued

DVD Players/Recorders	
Brand	Code
Curtis Mathes	21087
CyberHome	21129, 21117, 21024, 21023, 20874, 20816
Daewoo	21242, 21234, 21172, 21169, 20869, 20833, 20784, 20705
Daytek	20872
Denon	20634, 20490
Desay	21407
Disney	21270, 20675
Dual	21085, 21068
Durabrand	21127
DVD2000	20521
Emerson	21268, 20675, 20591
Enterprise	20591
Fisher	20670
Funai	21334, 21268, 20675
Gateway	21158, 21077, 21073
GE	20815, 20717, 20522
Go Video	21730, 21304, 21158, 21144, 21099, 21075, 21044, 20869, 20833, 20783, 20744, 20741, 20715
Go Vision	21072
GoldStar	20741
GPX	20769, 20699
Gradiente	20490
Greenhill	20717
Grundig	20539
Harman/Kardon	20702, 20582
Hitachi	20664, 20573
Hiteker	20672
iLo	21348
Initial	20717
Integra	20627, 20571
Jaton	21078
JBL	20702
JSI	21423
JVC	21275, 21164, 20867, 20623, 20558
jWin	21051, 21049
Kawasaki	20790
Kenwood	20737, 20682, 20534, 20490
KLH	21149, 21020, 20790, 20717
Konka	20721, 20711
Koss	21423, 20896, 20651
Landel	20826
Lasonic	21173, 20798
Lecson	21533
Lenoxx	21127
LG	20869, 20801, 20741, 20591
LiteOn	21440, 21416, 21158, 21058
Loewe	20511
Magnavox	20675, 20646, 20539, 20503
Malata	21159, 20782
Marantz	20539

DVD Players/Recorders	
Brand	Code
McIntosh	21533, 21273
Memorex	21270, 20831, 20695
Microsoft	20522
Mintek	20839, 20717
Mitsubishi	21521, 20521
Momitsu	21082
Myryad	20894
NAD	20741, 20692, 20591
Nakamichi	21222
NEC	20785
Nesa	20717
Next Base	20826
NexxTech	21402
Norcent	21265, 21107, 21003, 20872
Onkyo	20792, 20627, 20503
OptoMedia Electronics	20896
Oritron	20651
Panasonic	21762, 20703, 20632, 20503, 20490
Philips	21354, 21267, 20675, 20646, 20539, 20503,
PianoDisc	21024
Pioneer	21571, 20632, 20631, 20571, 20525
Polaroid	21086, 21061, 21020
Polk Audio	20539
Portland	20770
Princeton	20674
Proceed	20672
Proscan	20522
ProVision	20778
Qwestar	20651
RCA	20822, 20790, 20717, 20571, 20522
Rio	20869
RJTech	21360
Rotel	21178, 20623
Rowa	20823
Sampo	20752, 20698
Samsung	21075, 21044, 20820, 20744, 20573, 20490
Sansui	20695
Sanyo	20873, 20695, 20670
Sensory Science	21158
Sharp	21256, 20752, 20675, 20630
Sharper Image	21117
Sherwood	21077, 21043, 20770, 20633
Shinsonic	20839, 20533
Sigma Designs	20674
Sonic Blue	21099, 20869
Sony	21533, 21431, 21033, 20864, 20533
Sungale	21074
SVA	21105, 20860
Sylvania	21268, 20675
Symphonic	21268, 20675
TAG McLaren	20894
Teac	20809, 20790

Programming Codes, continued

DVD Players/Recorders	
Brand	Code
Technics	20703, 20490
Technosonic	20730
Techwood	20692
Terapin	21031
Theta Digital	20571
Toshiba	21154, 20695, 20503
Tredex	20804, 20803, 20800, 20799
Urban Concepts	20503
US Logic	20839
Venturer	20790
Vizio	21226, 21064
Vocopro	21027
Xbox	20522
Xwave	21001
Yamaha	20545, 20539, 20490
Yamakawa	20872
Zenith	20869, 20741, 20591, 20503
Zoece	21265

Laser Disc Players	
Brand	Code
Aiwa	20203
Carver	20323, 20194, 20064
Denon	20243, 20241, 20172, 20059
Disco Vision	20023
Funai	20203
Harman/Kardon	20194
Hitachi	20023
Kenwood	20258
Magnavox	20243, 20241, 20217, 20194
Marantz	20194, 20064
Mitsubishi	20059
NAD	20059
Optimus	20059
Panasonic	20204
Philips	20194, 20064
Pioneer	20059, 20023
Polk Audio	20194
Quasar	20204
Realistic	20203
Samsung	20323
Sega	20023
Sony	20270, 20201, 20193
Technics	20204
Theta Digital	20194
Yamaha	20451, 20217

Satellite Receivers	
Brand	Code
AlphaStar	10772
Chaparral	10216
Crossdigital	11109

Satellite Receivers	
Brand	Code
DirecTV	11856, 11749, 11640, 11639, 11609, 11444, 11443, 11442, 11414, 11392, 11377, 11142, 11109, 11108, 11076, 10819, 10749, 10724, 10639, 10566, 10392, 10247, 10099
Dish Network System	11775, 11505, 11170, 11005, 10775,
Dishpro	11775, 11505, 11005, 10775
Echostar	11775, 11505, 11170, 11005, 10775
Expressvu	11775, 10775
GE	10566, 10392
General Instrument	10869
GOI	11775, 10775
Goodmans	11246
Hisense	11535
Hitachi	11250, 10819
HTS	11775, 10775
Hughes Network Systems	11749, 11444, 11443, 11442, 11142, 10749
iLo	11535
Jerrold	10869
JVC	11775, 11170, 10775
LG	11414, 11226
Magnavox	10724, 10722
Memorex	10724
Mitsubishi	10749
Motorola	10869, 10856
NEC	11270
Next Level	10869
Panasonic	10701, 10247
Paysat	10724
Philips	11749, 11442, 11142, 11076, 10819, 10749, 10724, 10722, 10099
Pioneer	11442
Proscan	10566, 10392
Proton	11535
RadioShack	10869
RCA	11392, 10855, 10566, 10392, 10143,
Samsung	11609, 11442, 11377, 11276, 11142, 11109, 11108
Sanyo	11219
Sony	11640, 11639, 10639
Star Choice	10869
Tivo	11444, 11443, 11442, 11142
Toshiba	11749, 11285, 10819, 10790, 10749
UltimateTV	11640, 11392
Uniden	10724, 10722
US Digital	11535
USDTV	11535
Voom	10869
Zenith	11856

Programming Codes, continued

VCRs and DVRs	
Brand	Code
ABS	21972
Admiral	20479, 20209, 20048
Adventura	20000
Aiko	20278
Aiwa	20307, 20124, 20037, 20000
Akai	20242, 20175, 20106, 20061, 20041
Alienware	21972
America Action	20278
American High	20035
Asha	20240
Audiovox	20278, 20037
Beaumarck	20240
Bell & Howell	20104
Broksonic	20479, 20295, 20209, 20184, 20121, 20002
Calix	20037
Canon	20035
Capehart	20020
Carver	20081
CCE	20278, 20072
Citizen	20278, 20037
Colt	20072
Craig	20271, 20240, 20072, 20047, 20037
Curtis Mathes	20760, 20162, 20060, 20041, 20035
Cybernex	20240
CyberPower	21972
Daewoo	20637, 20561, 20278, 20045, 20020
Daytron	20020
Dell	21972
Denon	20042
DirecTV	20739
Durabrand	20039, 20038
Dynatech	20000
Electrohome	20043, 20037
Electroponic	20037
Emerex	20032
Emerson	21593, 20637, 20593, 20561, 20479, 20295, 20278, 20212, 20209, 20208, 20184, 20121, 20068, 20061, 20043, 20037, 20036, 20002, 20000
Fisher	20104, 20066, 20054, 20047
Fuji	20035, 20033
Funai	21593, 20593, 20000
Garrard	20000
Gateway	21972
GE	20761, 20760, 20240, 20202, 20060, 20035
Go Video	20643, 20526, 20432, 20240
GoldStar	20038, 20037
Gradiente	20000

VCRs and DVRs	
Brand	Code
Harley Davidson	20000
Harman/Kardon	20081, 20075, 20038
Harwood	20072, 20068
Headquarter	20046
Hewlett Packard	21972
HI-Q	20047
Hitachi	20105, 20089, 20042, 20041, 20000
Howard Computers	21972
HP	21972
Hughes Network Systems	20739, 20042
Humax	20739
Hush	21972
iBUYPOWER	21972
Jensen	20041
JVC	21162, 20067, 20041, 20008
KEC	20278, 20037
Kenwood	20067, 20041, 20038
KLH	20072
Kodak	20037, 20035
LG	21037
Linksys	21972
Lloyd's	20208, 20000
Logik	20072
LXI	20037
Magnasonic	20593
Magnavox	20593, 20563, 20149, 20110, 20081, 20039, 20035, 20000
Magnin	20240
Marantz	20081, 20035
Marta	20037
Matsushita	21162, 20162, 20035
Media Center PC	21972
MEI	20035
Memorex	21262, 21162, 21037, 20479, 20307, 20240, 20209, 20162, 20104, 20048, 20047, 20046, 20039, 20037, 20035, 20000
MGA	20240, 20061, 20043
MGN Technology	20240
Microsoft	21972
Mind	21972
Minolta	20105, 20042
Mitsubishi	20443, 20242, 20214, 20173, 20075, 20067, 20061, 20043
Motorola	20048, 20035
MTC	20240, 20000
Multitech	20072, 20000
NEC	20104, 20067, 20041, 20040, 20038
Nikko	20037
Nikon	20034
Niveus Media	21972
Noblex	20240
Northgate	21972
Olympus	20035
Onkyo	20222

Programming Codes, continued

VCRs and DVRs	
Brand	Code
Optimus	21262, 21162, 21062, 21048, 20593, 20432, 20162, 20104, 20048, 20037
Optonica	20062
Orion	20479, 20295, 20209, 20184, 20002
Panasonic	21262, 21162, 21062, 20616, 20225, 20162, 20077, 20035
Penney	20240, 20054, 20042, 20040, 20038, 20037, 20035
Pentax	20105, 20042
Philco	20035
Philips	21181, 21081, 20739, 20618, 20110, 20081, 20062, 20035
Pilot	20037
Pioneer	20067
Polk Audio	20081
Portland	20020
Profitronic	20240
Proscan	20761, 20760, 20202, 20060
Protec	20072
Pulsar	20039
Quarter	20046
Quartz	20046
Quasar	21162, 20162, 20077, 20035
RadioShack	21037, 20000
Radix	20037
Randex	20037
RCA	20880, 20761, 20760, 20240, 20202, 20149, 20106, 20105, 20077, 20060, 20042
Realistic	20104, 20066, 20062, 20048, 20047, 20046, 20037, 20035, 20000
ReplayTV	20616, 20614
Ricavision	21972
Ricoh	20034
Runco	20039
Salora	20075
Samsung	20739, 20240, 20045
Samtron	20643
Sanky	20048, 20039
Sansui	20479, 20271, 20209, 20067, 20041, 20000
Sanyo	20240, 20159, 20104, 20047, 20046
Scott	20212, 20210, 20184, 20121, 20045, 20043
Sears	20105, 20104, 20066, 20054, 20047, 20046, 20042, 20037, 20035, 20000
Sharp	20848, 20062, 20048
Shintom	20072
Shogun	20240

VCRs and DVRs	
Brand	Code
Singer	20072
Sonic Blue	20616, 20614
Sony	21972, 21032, 20636, 20035, 20034, 20033, 20032, 20000
Stack 9	21972
STS	20042
Sylvania	21593, 20593, 20110, 20081, 20043, 20035, 20000
Symphonic	21593, 20593, 20000
Systemax	21972
Tagar Systems	21972
Tatung	20041
Teac	20041, 20000
Technics	20162, 20035
Teknika	20037, 20035, 20000
Thomas	20000
Tivo	21503, 20739, 20636, 20618
TMK	20240, 20208, 20036
Toshiba	21972, 21503, 21008, 20212, 20210, 20209, 20066, 20045, 20043
Totevision	20240, 20037
Touch	21972
Unitech	20240
Vector	20045
Vector Research	20040, 20038
Video Concepts	20061, 20045, 20040
Videomagic	20037
Videosonic	20240
Viewsonic	21972
Villain	20000
Voodoo	21972
Wards	20760, 20240, 20212, 20149, 20081, 20072, 20062, 20060, 20048, 20047, 20042, 20035, 20000
White Westinghouse	20637, 20209, 20072
XR-1000	20072, 20035, 20000
Yamaha	20038
Zenith	21139, 20637, 20479, 20209, 20039, 20034, 20033, 20000
ZT Group	21972

6

Using the TV with a Personal Computer

Setup	76
Video Adjustments	76
Connecting a Computer to the TV	77
Adjusting Image Resolution	79
Computer Display Formats	80

Setup

1. See the TV specifications in Appendix B to confirm that your computer video signal is compatible with the TV.
2. Note whether the computer supplies a digital or analog video signal. You will need this information during the setup procedure.
 - Digital video signal: Comes from the computer's DVI or HDMI output.
 - Analog video signal: Comes from the computer's VGA 15-pin output and requires a VGA-to-DVI cable or a VGA cable and VGA/DVI adapter.
3. Power on the TV.

IMPORTANT

In the next step, select the correct video signal type (analog or digital) in the Input Name menu. Otherwise, the TV will be unable to display a picture from the computer.

4. Press **MENU** to open the Main menu, highlight the **Input Name** icon and press **ENTER**.
5. Highlight the **PC-DVI** text box and press **▼** to change the setting to match your computer's video signal type, either **Digital** or **Analog**.

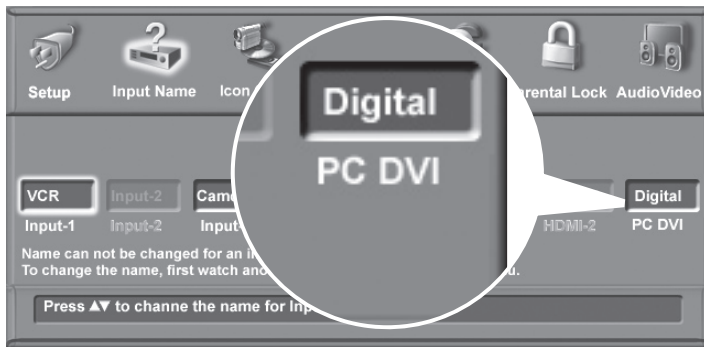

Figure 1. Specify your computer's video signal type (analog or digital) in the Input Name menu.

6. Press **EXIT** to close all menus.
7. Connect the computer's video output to the TV's **PC-DVI** jack. See the connection diagrams in this chapter to find the method best suited to your equipment.
8. Connect the computer's audio output using one of these options:
 - Connect analog left/right audio to the TV's **PC -DVI AUDIO** jack.
 - If your computer offers digital audio output, connect it to a digital A/V receiver instead.

IMPORTANT

See Appendix B for signal compatibility.

Video Adjustments

1. Power on the computer if it is not already on.
2. Select **PC** from the Input Selection menu. To do this, press **INPUT** to open the Input Selection menu, move the highlight to the PC icon, and press **ENTER**.
3. Change the resolution of the computer image. The goal is to maximize the computer resolution while maintaining a suitable aspect ratio for the image. See the explanation later in this chapter.
4. Perform TV video adjustments. Press **VIDEO** repeatedly to cycle through the video-adjustment options. The following additional adjustments are available for computer video:

Auto Position. Press **ENTER** to automatically center the position of the PC video.

HorizPosition (Horizontal Position). Manually adjust the horizontal position of the PC. This selection overrides the **Auto Position** selection.

VertPosition (Vertical Position). Manually adjust the vertical position of the PC. This selection overrides the **Auto Position** selection.

Fine Detail (analog DVI-A signals only). Manually adjust the picture quality of the PC. This selection overrides the **Auto Position** selection.

5. Change the TV picture format to suit the image. Press **FORMAT** to cycle through the available picture formats. See the chart later in this chapter showing how various computer resolutions are displayed on the TV.

To Remove the Computer Icon from the Input Selection Menu

When you disconnect an analog video connection from a personal computer, the computer icon remains in the Input Selection menu until you remove it.

1. In the Input Name menu, highlight the **PC DVI Input** box.
2. Press **▼** to select **Digital**.
3. Press **EXIT** to close all menus.

The next time you open the Input Selection menu, the computer icon will no longer appear.

Note

- The **PC-DVI** input on the TV can accept either analog (DVI-A) or digital (DVI-D) signals.
- You must specify the **PC-DVI** setting in the Input Name menu as either **Analog** or **Digital**, depending on the signal type sent by your computer.
- If your computer offers digital audio output, you can connect your computer's digital audio out to a digital input on a digital A/V receiver.

Connecting a Computer to the TV

Computer with DVI Monitor Output

Required: DVI-to-DVI cable, stereo audio cables

If the computer's audio output is a single mini jack, a mini audio-to-RCA-male "Y" adapter cable is also required.

1. Connect the DVI-to-DVI cable from the computer **DVI** output to the **PC-DVI** jack on the TV back panel.
2. Connect the left (white) and right (red) audio cables from **AUDIO OUT** on the PC back panel to **PC-DVI AUDIO** on the TV back panel.

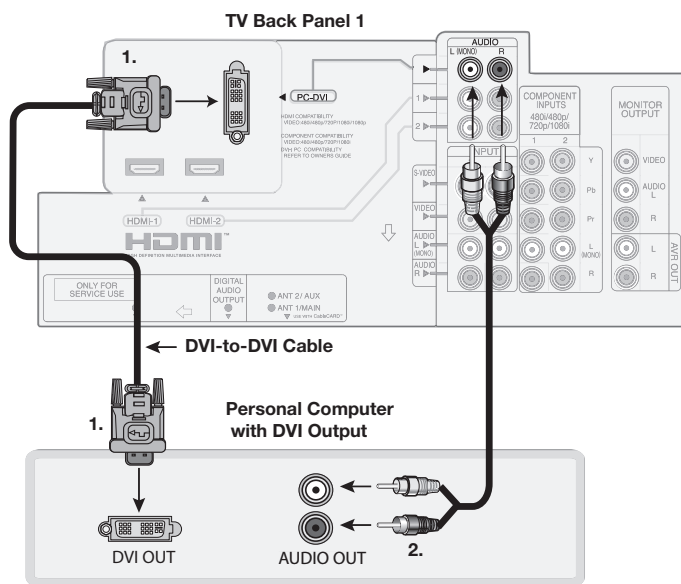

Figure 2. Connecting a personal computer with DVI Monitor Output

Computer with HDMI Monitor Output

Required: HDMI-to-DVI cable or an HDMI cable with an HDMI/DVI adapter, stereo audio cables

If the computer's audio output is a single mini jack, a mini audio-to-RCA-male "Y" adapter cable is also required.

1. Connect the computer's **HDMI** output to the TV's **PC-DVI** jack. Use either an HDMI-to-DVI cable or an HDMI cable with an HDMI/DVI adapter.
2. Connect the left (white) and right (red) audio cables from the computer's **AUDIO OUT** to **PC-DVI AUDIO** on the TV back panel.

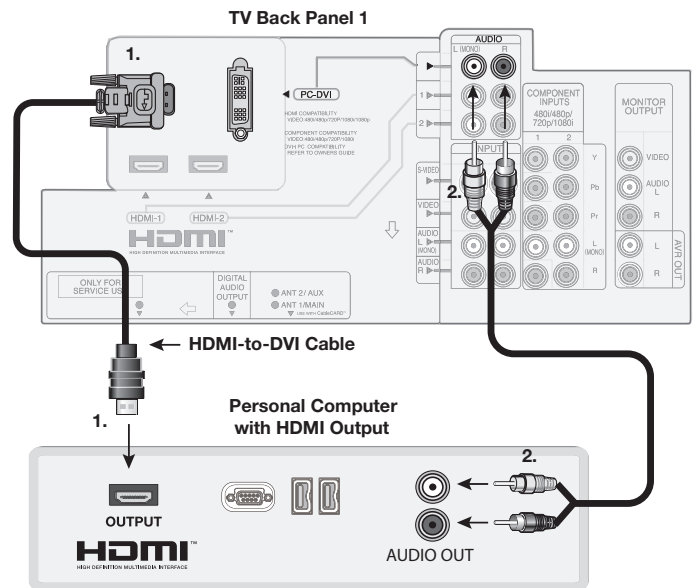

Figure 3. Connecting a personal computer with an HDMI monitor output

Connecting a Computer to the TV, continued

Computer with VGA 15-Pin Monitor Output (Analog Video)

Required: 15-pin computer VGA-to-DVI cable or a VGA computer cable and a DVI/VGA adapter, stereo audio cable.

If the computer's audio output is a single mini jack, a mini audio-to-RCA-male "Y" adapter cable is also required.

IMPORTANT

To use this connection, you must first select the **Analog** setting in the PC DVI box of the Input Name menu. See the "Setup" section for more.

1. Connect the computer's **PC MONITOR OUT** to **PC-DVI** on the TV back panel. Use either a VGA-to-DVI monitor cable or a VGA computer cable with a VGA/DVI adapter.
2. Connect the left (white) and right (red) audio cables from the computer's analog audio output to **PC-DVI AUDIO** on the TV back panel.

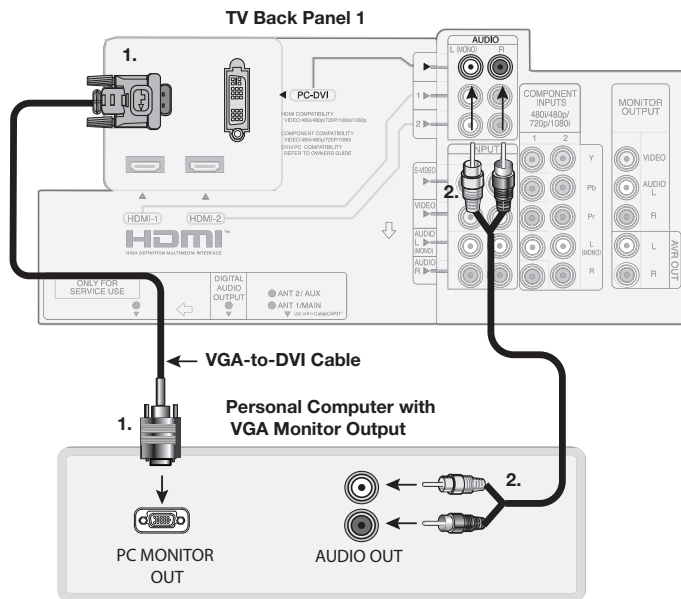

Figure 4. Connecting a computer with a VGA 15-pin monitor output.

Adjusting Image Resolution

Your Mitsubishi TV can display resolutions from standard VGA (640 x 480) through 1920 x 1080 signals at a refresh rate of 60 Hz. Note that 1280 x 1024 and 1920 x 1080 signals are supported only for digital computer signals, and 1920 x 1080 at 24, 30, and 60 Hz. See Appendix B in this book for more on compatible screen resolutions.

In most cases, the computer will select the best resolution match to display on the TV. You can override this setting if you wish. The instructions below are for setting the resolution on most personal computers.

1. In the PC's Start menu, select **Settings**.
2. Select **Control Panel**.
3. Select **Display**.
4. Choose the **Settings** tab.
5. Change the resolution to the highest resolution with the aspect ratio best suited for the image. See the table on the next page showing possible PC formats. Depending on your computer's operating system, adjust the resolution with either:
 - the Screen area slider.
 - the Screen Resolution slider
6. To change the refresh rate, click on the **Advanced** button.

7. On the **Monitor** tab, select a setting from the Screen refresh rate drop-down list. The resolution of 1920 x 1080 is supported at 24, 30, and 60 Hz; other resolutions are supported at 60 Hz.

You may need to restart the computer for this change to take effect.

NOTE: Whenever the TV is powered on, the lamp is in use, even if the TV screen appears dark. As a reminder that the TV is powered on and that time is being added to the lamp's elapsed hours, set the computer's screen saver to a pattern that will display after several minutes of inactivity.

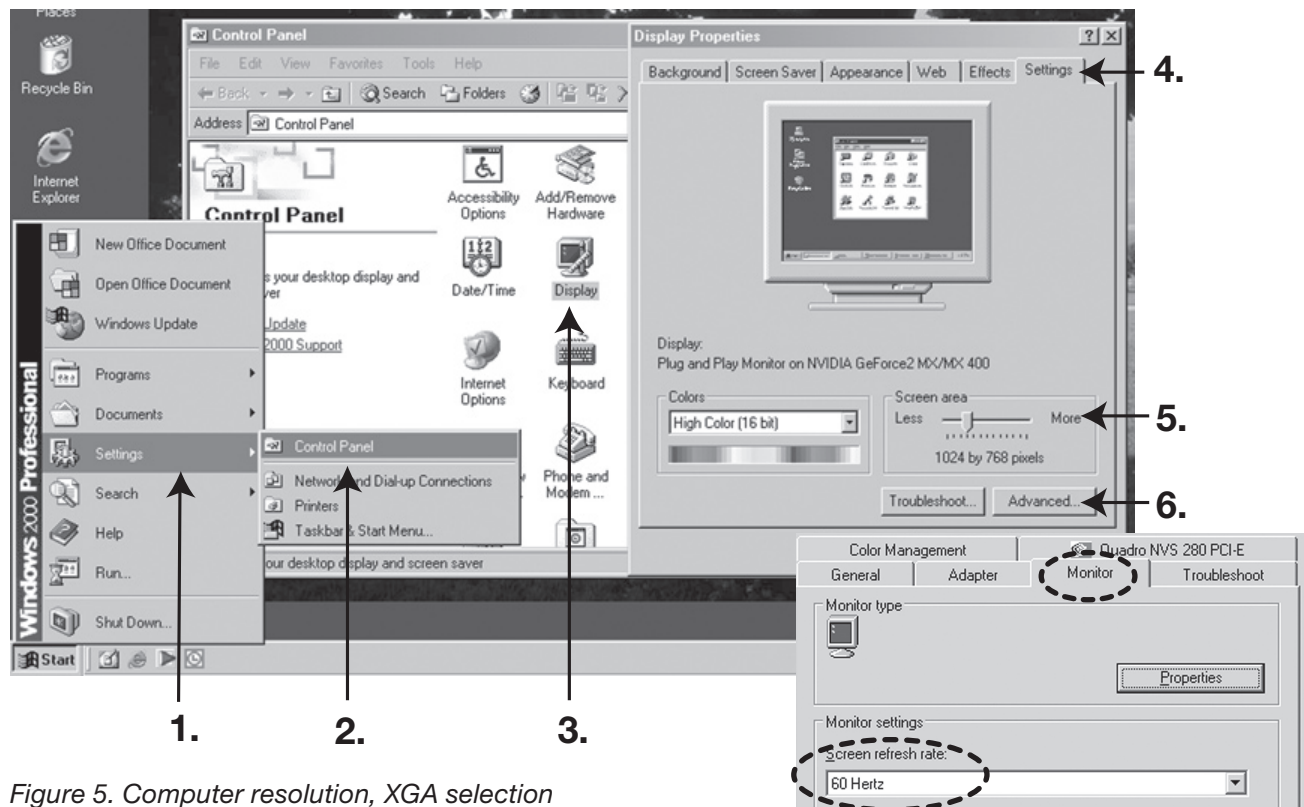
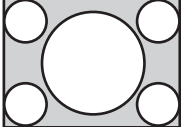
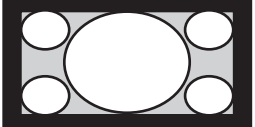
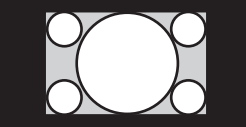
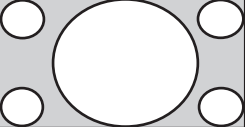
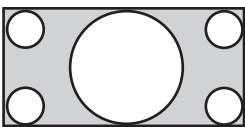
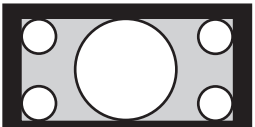
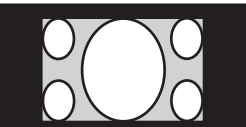
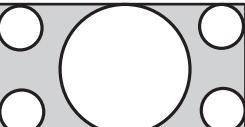
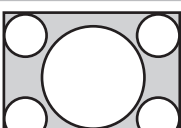
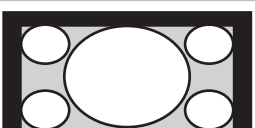
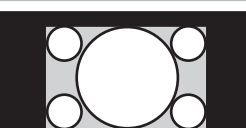
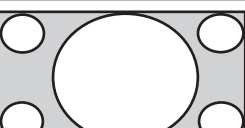
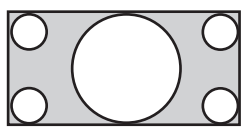
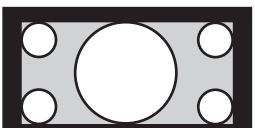
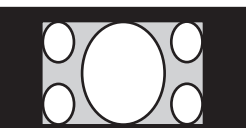
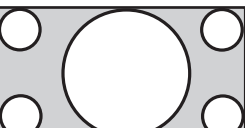
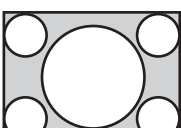
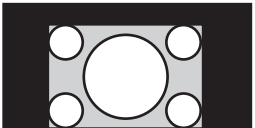

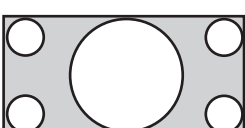
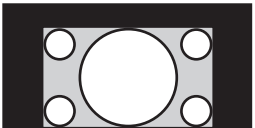
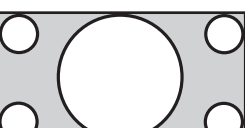
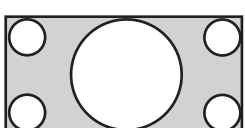
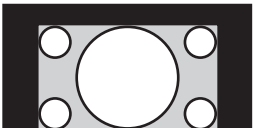
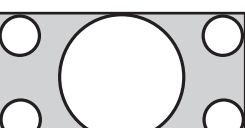
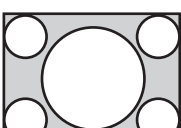
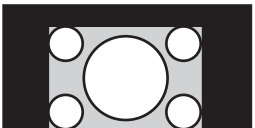
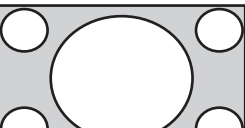
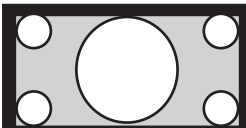
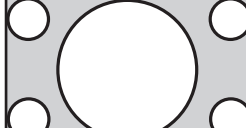

Figure 5. Computer resolution, XGA selection

Computer Display Formats

Repeatedly press the **FORMAT** key to cycle through the TV displays available for your computer's video signal.

Computer Signal		As Displayed on TV Screen		
Format		16 X 9 Standard	4 X 3 Standard	Zoom
VGA 640 X 480				
WVGA 848 X 480				
SVGA 800 X 600				
WSVGA 1064 X 600				
XGA 1024 X 768				
PC 720p 1280 X 720				
WXGA 1365 X 768				
SXGA 1280 X 1024 (DVI-D signals only)				

Format	Reduced	Standard
PC 1080p 1920 X 1080 (DVI-D signals only)		

Using IEEE 1394 Devices

Overview	82
Recording to IEEE 1394 Recordable Devices	84
The TV Remote Control and IEEE 1394 Devices	86
A/V Discs.	87
Switching Between Analog and Digital IEEE 1394 Outputs	88

Overview

Compatible IEEE 1394 Devices

Compatible A/V devices include some, but not all, cable boxes, D-VHS VCRs, A/V discs, and future products. Some devices may have IEEE 1394 connectors but are not compatible with the TV. Areas of compatibility to consider are:

1. Digital Video Signals

The TV can decode MPEG2 video as provided by cable boxes and some camcorders. Many camcorders provide DV video, which the TV cannot decode. Connect a DV camcorder to the TV using analog audio plus composite video, S-video, or component video, or use HDMI audio/video. Other types of digital video, such as PC video provided by some computers, must be decoded by the source device and sent to the TV as analog video, S-video, or DVI/HDMI video.

2. Digital Audio Signals

When received with video signals, the TV can decode Dolby Digital signals and MPEG audio signals. Other types of digital audio as provided by some digital recording devices, such as DTS audio, cannot be decoded by the TV when received over IEEE 1394 connections.

The TV may not be able to pass incompatible digital audio signals on the coaxial digital audio output. These signals may pass to other devices, however, on the IEEE 1394 cable.

3. Digital Control Signal

The TV can serve as the control center for IEEE 1394 audio/video devices, such as VCRs, A/V Discs, tuners, cable boxes, and amplifiers that are compatible with the following IEEE 1394 control standards.

- **EIA-775.** Designed for tuning devices such as cable boxes, allowing the device to send simple graphics. This standard does not, however, allow the TV to control the cable box by IEEE 1394.
- **AV/C (Audio Video Control).** Designed to provide basic controls such as play, stop, channel selection, and volume, as appropriate for the device.

Four-Pin and 6-Pin Connections

There are two different types of connectors used for IEEE 1394 terminals and cables: a 4-pin and a 6-pin type. Both types send the same digital audio, video, and control signals, but the 6-pin connectors can also supply low-voltage electrical power to connected devices. This TV uses only 4-pin type connectors.

A 6-pin connector cannot be connected directly to a 4-pin jack, and vice versa. To connect a 6-pin device to a 4-pin device, use a 6-pin-to-4-pin adapter or adapter cable. These cables are available from electronics and computer stores.



4-pin connector 6-pin connector 6-pin-to-4-pin adapter

If you wish to connect a 6-pin device to the TV (such as a camcorder), and the device is designed to receive electrical power from another 6-pin device, there are several ways to provide electrical power to the device:

- Connect the camcorder directly to the household AC.
- Use the camcorder's battery for power.
- Connect the camcorder directly to another 6-pin device in the network that can provide power.

Connection Methods

There are two connection methods for IEEE 1394 devices. Use the method that fits your network of audio/video products.

Direct Device-To-Device Method

The IEEE 1394 interface allows you to chain devices, unlike audio and video connections that require you to connect each individual device directly to the TV. For example, you can connect your D-VHS to your 1394 A/V disc and then connect the 1394 A/V disc to the TV. The resulting IEEE 1394 chain allows you to add more devices to the chain. You will see an icon for each device in the TV's Input Selection menu and can also send information from any IEEE 1394 device to other compatible devices.

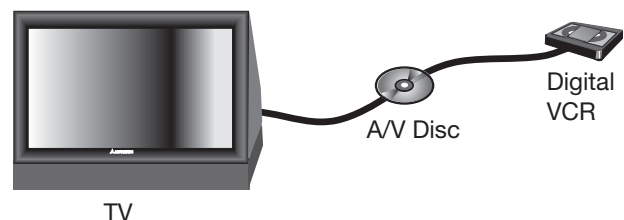

Hub Connection Method

The IEEE 1394 standard allows you to use the TV as a hub within the audio/video network. Each device can send information, which may include audio and video, to any other device in the network.

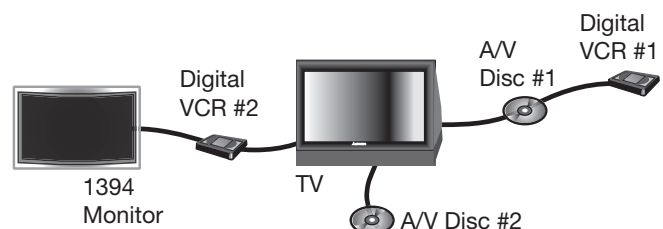

Overview, continued

Tips for Connecting IEEE 1394 Devices

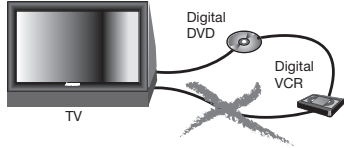
- Do not loop the last device in the chain back to the TV. When the device chain is looped, the TV may not be able to work with the other devices.
- 
- Place devices that have only a mechanical (two-position) power switch at the end of the chain or leave the power switch in the on position. When turned off, IEEE 1394 signals may not be able to pass through the device to other devices.
 - Place devices with the slowest communication speed at the end of the chain. Sometimes the communication speed is marked near the IEEE 1394 connector with an “S” number. The higher the number, the faster the communication speed. This TV has a communication speed of s400. Devices with slow communication speeds can interfere with IEEE 1394 signals from faster devices. When setting up a digital recording between a faster device and a slower device, make the slower device the source and make the faster device the recorder.
 - Use IEEE 1394 cables 15 feet or less in length between devices.
 - This TV is an IEEE 1394a device. It can be used with an IEEE 1394b system when an IEEE-1394a-to-1394b convertor is used. 1394b systems are capable of greater distances and multi-room applications.
 - The TV can recognize a maximum of seven IEEE 1394 devices.

IEEE 1394 Devices and the Input Selection Menu

Select an IEEE 1394 device to watch from the Input Selection menu just as you would any other device. See figure 3, Input Selection menu.

When you connect an IEEE 1394 device to the TV network and power it on, the new device is automatically detected. Some non-audio/video or incompatible IEEE 1394 devices, such as personal computers (PCs), may not be detected by the TV and do not appear in the Input Selection menu. Such devices can, however, coexist and are still available to other devices on the IEEE 1394 network that are compatible with these non-audio/video devices.

Some devices may be a combination of two or more types of devices, such as a recording device that is also a tuning device. Each portion of the device is called a sub-unit. When you select a device on the Input Selection menu

that has sub-units, a pop-up menu will appear to allow you to select the sub-unit you wish to use.

IEEE 1394 Amplifiers

You can use the TV to control switching between the TV speakers and speakers connected to your IEEE 1394 amplifier.

- Press **INPUT** to open the Input Selection menu. The screen will show an icon for a connected IEEE 1394 amplifier. If an IEEE 1394 amplifier has been connected, AVR and TV speaker icons will display.
- Press **AUDIO** to move the highlight to the audio section.
- Press **◀ ▶** to select either the TV speakers or the IEEE 1394 amplifier.
- Press **ENTER** to select and hear the new audio source.

IEEE 1394 Camcorders

- Control Functions.** Connect the camcorder to the TV’s IEEE 1394 jack on the rear of the TV and test using the TV’s remote control to operate the camcorder. If your model does not operate properly, use the camcorder’s control buttons instead.
- MPEG Camcorder.** If you are unable to play back over the IEEE 1394 interface, use the analog audio/video connections described in chapter 2, “TV Connections.”
- DV Camcorder.** Connect the camcorder using the analog audio and video connections described in chapter 2, “TV Connections.”

You can connect an IEEE 1394 camcorder with an IEEE 1394 cable or with analog audio/video cables. In either case, test using the TV’s remote control to operate the camcorder over the IEEE 1394 cable.

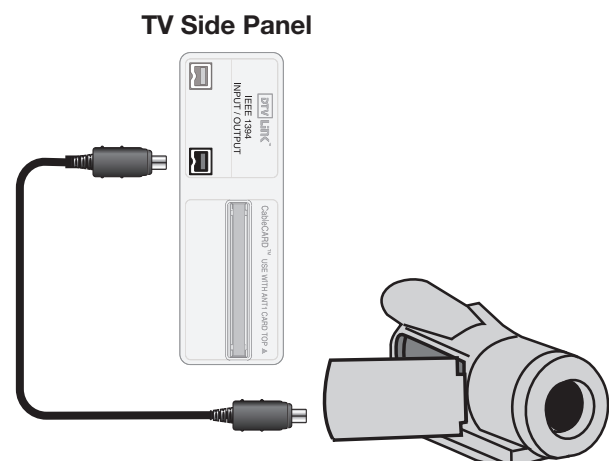

Recording to IEEE 1394 Recordable Devices

You can use the TV to control recording to IEEE 1394 devices. While recording, you can view a program on a different input or power off the TV. The following table lets you see what signals can be recorded to an IEEE 1394 digital VCR or A/V disc.

Recording Availability	Signal Type	TV Input
Can be recorded	Digital channels, including high-definition channels	ANT 1, ANT 2
	Digital signals, including high-definition signals	IEEE 1394 devices
Cannot be recorded	Analog channels	ANT 1, ANT 2
	Analog signals	INPUT 1-3, COMPONENT 1 and 2
	Digital signals	HDMI 1 and 2, PC-DVI

Summary of signal inputs and recording to an IEEE 1394 digital VCR or A/V disc.

There are two ways to record digital content to an IEEE 1394 recordable A/V disc or DVCR:

- From the TV's Recording Setup menu
- From the TV's ChannelView™ channel guide

Immediate Recording from the Recording Setup Menu

Recording Now from the Menu

1. Press **(RECORD)** to open the Recording Setup menu.

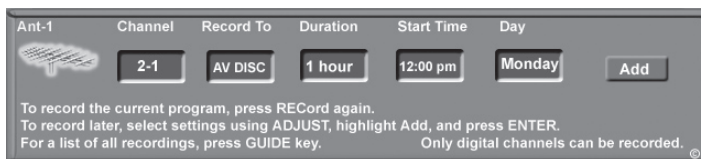

Figure 1. The Recording Setup menu

2. Review the recording setup information. Move the highlight to each box you need to change.
 - With the leftmost icon highlighted (the source), press **▲▼** to change the source input if needed.
 - **Channel.** If the source is an antenna, select a memorized digital channel using **▲▼, CH ▲/▼**, or enter the channel number from the remote control.
 - **Record To.** If you have more than one recordable IEEE 1394 device connected, use **▲▼** to select it from the list in the **Record To** box.

- **Duration.** Use **▲▼** to select a recording duration of from 30 minutes to six hours in 30-minute increments. The default is one hour.

3. Press **(RECORD)** a second time to start recording.

Time-Delayed Recording from the Menu

1. Ensure that TV Energy Mode is set to **Fast Power On** and the TV clock is set to the correct time and day. See "Setup Menu" to make changes.
2. Press **(RECORD)** to open the Recording Setup menu.
3. Review the recording setup information. To change the source, recording device, or duration, follow the steps described above under "Recording Now."
4. Specify when to start the recording.
 - **Start Time**
 - a. With the hour highlighted in gold characters, press **▲▼** to select the hour, including **AM** or **PM**. Press **ENTER** to move the highlight to the minutes.
 - b. With the minutes highlighted, press **▲▼** to select the minutes.
 - **Day.** Use **▲▼** to select a day of the week.
5. Select **Add** and press **ENTER** to add the recording to the Record List. A confirmation message will be displayed if your selection is successful. If you pick overlapping times, day(s), or destination devices, you will see a message stating there is a conflict.
6. While the Recording Setup menu is displayed, press **GUIDE** to view a list of scheduled recordings and verify the addition of the recording to the Record List, figure 2.
7. From the Record List you can:
 - Press **GUIDE** to return to the Recording Setup menu.
 - Press **EXIT** to return to TV viewing,

Record List				
The list of recordings for the next week. To cancel a recording, select the recording with the ADJUST keys, then press the CANCEL key. Press the GUIDE key to return to the Record screen.				
Day	Start	Duration	Device	Record To
Monday	8:00 pm	1 hour	Ant-1 5-1	DVCR
Tuesday	8:00 pm	1 hour	Ant-1 2-1	AV Disc
Every Wed	8:00 pm	30 min	Ant-1 2-1	AV Disc
Wed	9:00 pm	1 hour	Ant-1 4-1	AV Disc
Thursday	8:00 pm	1 hour	Ant-2 13-1	AV Disc
Thursday	9 :00pm	1 hour	Ant-1 7-1	DVCR
Friday	8:00 pm	30 min	Ant-2 2-1	AV Disc
Every Sat	11:30 pm	1 hour 30 min	Ant-1 4-1	DVCR

Figure 2. Record List screen. From the Record menu, press **GUIDE** to open the Record List to review or cancel scheduled recordings.

Recording to IEEE 1394 Recordable Devices, continued

Recording from the ChannelView™ Channel Guide

ChannelView provides program listings, as sent by the broadcasters, for memorized channels on **ANT 1** and **ANT 2**. Press the **GUIDE** key while watching **ANT 1** or **ANT 2** to view ChannelView listings and to set up immediate or future recordings as described here.

Immediate Recording from ChannelView

1. Press **INPUT** to open the Input Selection menu. Highlight an **ANT 1** or **ANT 2** program source and press **ENTER**.
2. Press **GUIDE** to open the ChannelView channel guide for the current input.
3. Use **▲▼** to highlight the digital channel and program you wish to record from the list of channels.
4. Press **RECORD**.
A red “R” temporarily displays next to the program listing to indicate the program will be recorded.
5. Press **EXIT** to return to TV viewing.

Time-Delayed Recording from ChannelView

Set Up the Recording

1. Ensure that TV Energy Mode is set to **Fast Power On** and the TV clock is set to the correct time and day. See “Setup Menu” in chapter 4, “TV Menu Settings.”
2. Perform steps 1 and 2 described above.
3. Press **▲▼** to highlight the source channel you wish to record from.
4. Press **▶** to view a list of future programs on that channel.
5. Press **▲▼** to highlight a future program.
6. Press **RECORD**.
A red “R” temporarily displays next to the program listing to indicate the program will be recorded. You can schedule a maximum of 32 recordings.
7. Press **EXIT** to close the menu.

Confirm the Recording Setup

1. Press **RECORD** to open the Record menu.
2. Press **GUIDE** to open the Record List (figure 2, on the previous page) and view all scheduled recordings. Press **CH ▲/▼** to page quickly through the list.
3. Verify that the program you wish to record appears in the list.
4. Press **EXIT** to close the menu.

Cancelling Recordings

To Cancel a Recording in Progress

1. Press **INPUT** to open the Input Selection menu.
2. Move the highlight to the source input icon. There is no need to press **ENTER**.
The Input Selection menu displays an icon for an active recording connection to a recordable IEEE 1394 device. See the IEEE 1394 connection icon in figure 3.
3. Press **CANCEL**. The connection icon will disappear to indicate termination of the recording connection.
4. Press **EXIT** to return to TV viewing.

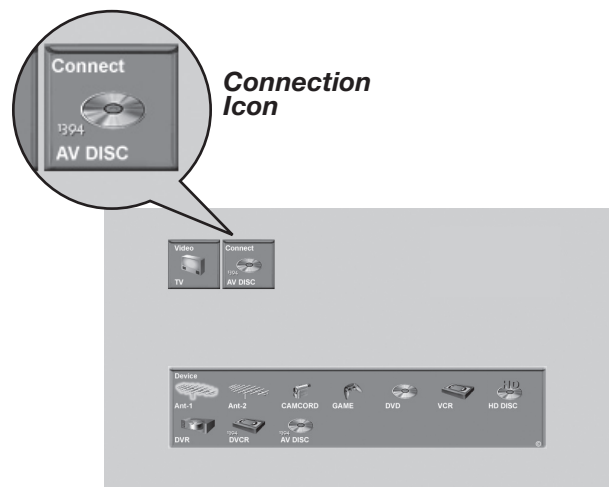

Figure 3. The Input Selection menu displays specialized icons for IEEE 1394 devices.

The audio icons are displayed (in the upper right corner) only when an IEEE 1394 amplifier is connected.

To Cancel a Scheduled Recording

1. Press **RECORD** to open the Record menu.
2. Press **GUIDE** to open the Record List (figure 2) and view all scheduled recordings. Press **CH ▲/▼** to page quickly through the list.
3. Highlight the program you wish to remove from the Record List and press **CANCEL**.
4. Press **EXIT** to close the menu.

The TV Remote Control and IEEE 1394 Devices

If the 1394 cable box or satellite receiver provides guide information for 1394 content:











- For compatible satellite receivers and some cable boxes, the TV remote control **GUIDE** key displays the on-screen programming guide for the receiver or cable box. Press **▲▼◀▶** and **ENTER** to navigate the displayed program guide.
- For satellite receivers, you may also be able to use the numbers or other additional buttons.
- For an IEEE 1394 cable box or satellite receiver, you can also try using the **CABLE/SAT** position of the TV remote control to see if it can operate the device. If not, use the remote control that came with the device.

To Power On or Off a Compatible IEEE 1394 Device

- Press **INPUT** to open the Input Selection menu.
- Move the highlight to the icon for the device. There is no need to press **ENTER**.
- Press **POWER**.
- Press **EXIT** to return to TV viewing.
Or: press **ENTER** to switch to the highlighted device.

Operation of IEEE 1394 Devices with the TV's Remote Control

(slide switch set to TV position)

Device 				AMPLIFIER (some MPEG2 models only)
Remote Control Key	CABLE/SAT	A/V DISC	DVCR	
POWER	Power the device on/off when highlighted in the Input selection menu. See the instructions above.			
CH  	Channel up/down	Page up/down (when track list is displayed)	Index search forward/ reverse (if supported by DVCR)	
VOL  				Volume Up/Down
MUTE				Mute On/Off
0-9 (DIGITS)	Number functions	Search by time (when followed by ENTER)		
QV	Last Channel Recall			
EXIT	Exit menus/displays	Exit menus/displays	Exit menus/displays	
ENTER	Enter or select	Enter or select	Enter or select	
CANCEL	Cancel function	Delete recording from Track List	Cancel function or counter reset	
GUIDE	Digital-channel guide (may need to press twice)	Display Track List.		
▲▼◀▶	Up/down/left/right	Skip Forward 30 seconds during playback Skip Backwards 12 seconds during playback Skip to end or beginning of program Up/down in track list	Up/down/left/right	
 PLAY		Play	Play	
 STOP		Stop	Stop	
 RECORD		Record	Record	
 REV		Reverse picture scan or Slow Play	Reverse or Slow Play	
 FFWD		Fast picture scan or Fast Play	Fast Play	
 PAUSE		Pause	Pause	

A/V Discs

A/V Disc Track List Screen

When viewing an A/V Disc:

- Press **GUIDE** to display its Track List (see figure below).
- Press **▲** or **▼** to navigate through the Track List.
- To play a track, select it on the list, then press **ENTER**.
- Press **INFO** to view details for a highlighted track.
- To move through listings quickly, press **PAGE ▲/▼**.
- To delete a track, highlight it and press **CANCEL**.

Track List for AV DISC					Free Disk Space: 11G	
Channel	Station	Date	Time	Program	Watched	
62	KNBC-DT	Su 7/25	8:00 pm	West Wing	N	
45 min 6G COPY FREE						
02.01	KCBS-DT	Su 8/08	5:30 pm	CBS Local News	N	
04.01	KNBC-DT	M 8/09	5:30 pm	NBC Evening News	Y	
7		M 8/09	8:00 pm		N	
1104	KNBC-DT	W 8/11	8:30 pm	NBC Evening News	N	

Select a program with the ADJUST keys. Press **ENTER** to watch the program. Press **CANCEL** to delete.

Figure 4. A/V Disc Track List screen

A/V Disc Search by Time

While playing an IEEE 1394 A/V disc you can search to a specific time in the recording.

1. Start playing the desired track on the A/V disc.
2. Use the number buttons to enter the time code position of hours followed by minutes. For example, to enter one hour and twenty-two minutes (1:22) into the track, enter 1, 2, 2.
3. Press **ENTER** to skip to the time code position. To cancel the request or to start over, press **CANCEL** instead of **ENTER**.

Copying or Moving A/V Disc Recordings

Tracks you record to disc may have copy restrictions assigned to them. To learn a track's copy status, highlight the track in the Track List and press **INFO**. Tracks are assigned one of these ratings:

Copy Free (or no status shown)	No copy restrictions apply.
Copy Never	The track cannot be transferred to another recording device. Tracks of this type may have an assigned retention period. See below for more information.

Copy Never, Movable	You can transfer the track to a different recording device. The track on disc is deleted as it is moved.
Copy No More	No more recordings are allowed. You have already recorded from another source.

Retention Period

Some **COPY NEVER** tracks have a retention period assigned by the content provider. The retention period is the length of time you can keep and view the recording. The initial retention period, if any, is shown next to the copy status in the Track List **INFO** display (see figure 4). To check how much time remains of the retention period, start viewing the recording and press **INFO**.

Note: The retention period for all tracks on the disc expires if there is any loss of power to the TV, even momentary. For example, expiration of the retention period will occur if you:

- Unplug the TV from the AC power source.
- Experience a power outage or power fluctuation.

Remember that you can safely turn off TV power using the **POWER** button without affecting the retention period.

To Copy or Move a Track to Another IEEE 1394 Device

1. Press **INPUT** on the remote control and press **▲▼◀▶** to select the source A/V disc. Press **ENTER** to open the Track List.
2. Press **▲** or **▼** to select a track. Then press **ENTER** to start playback.
3. Press **(||)** (**PAUSE**) to pause playback.
4. Press **(●)** (**RECORD**) on the TV remote. The Record menu will display.
5. In the **Record To** section, review the destination device (A/V Disc, DVCR). Change if necessary. If moving, leave the other settings unchanged.
6. Set the duration to the length of the original track or longer.
7. Press **(●)** a second time to start recording.

Switching Between Analog and Digital IEEE 1394 Outputs for the Same Device

To enable switching between analog and digital outputs for the same device, you must have check-marked the **Analog Connection** box when the New 1394 Device screen displayed when you first connected the device. See the section “Before You Begin” in chapter 2, “TV Connections.”



Figure 5. The ClearThought Auto Input sensing screen for IEEE 1394 devices. Place a check in the Analog Connection box if your device has both analog and digital outputs.

1. Press **INPUT** to display the Input Selection menu.
2. Highlight the icon for the IEEE 1394 device and press **ENTER**.
3. Press **▲ ▼** to switch between icons representing the analog and digital outputs of the device. See figure 6.

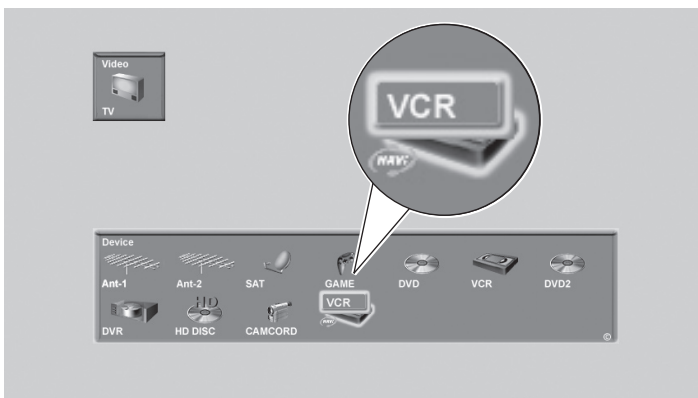

Figure 6. The Input Selection menu shows icons for the analog and digital outputs of the IEEE 1394 device.

4. Press **ENTER** to select the device output.

Appendices

Appendix A: Bypassing the Parental Lock	91
Appendix B: Specifications	93
Appendix C: Troubleshooting	95

Appendix A: Bypassing the Parental Lock

Lock Bypass Instructions Have Been Filed for Future Reference

IMPORTANT

Cut along the dotted line and file bypass instructions in a safe place for future reference.

Bypassing the Parental Lock

After you set the lock, you must use your pass code to view a locked program, view the locked TV, cancel the lock, or enter the Parental Lock menus.

If you forget your pass code, you can view the locked TV without entering your pass code. When you are prompted for your pass code, press the number 9 and QV buttons on the TV remote control at the same time. This process temporarily unlocks the TV.

When entering the Parental Lock menu, this process deletes your old pass code and prompts you to enter a new pass code.

- You can either enter a new pass code to open the Parental Lock menu and make changes or press EXIT to close the menu.
- If any of the locks are turned on and you exit the menus when prompted for a new code, the old code and all lock settings are retained.
- If all locks are turned off and you exit the menus when prompted for a new code, then the previous code is erased.

IMPORTANT

When changing or deleting your pass code, you must use the remote control included with this TV. You cannot use a Mitsubishi remote control from another component or a “universal” remote.

This page intentionally left blank

Appendix B: Specifications

Picture Technology		
LCD Screen	Color active matrix LCD 1920 x 1080 dots	
Backlight	LT-37131: Direct Type 18 CCFTs ; LT-46131: Direct Type 24 CCFTs	
Reception		
Channel Frequency Reception	Over-the-Air: VHF 2–13, UHF 14–69 Analog Cable: 1–125 Digital Cable: 1–135	
Channel Type*	Over the Air:	Analog NTSC, Digital ATSC with sub-channels (all 18 video formats)
	Cable:	Analog NTSC (non-scrambled) Digital QAM 64 and 256 with sub-channels (non-scrambled)
	CableCARD™: (LT-37131, LT-46131)	Authorized scrambled and non-scrambled digital channels
<p>* Note for Digital Channels: The channel numbers displayed on screen are determined by the broadcaster or cable company and can vary from the standard frequency number. If there is no channel-number information provided by the broadcaster or cable company, the TV creates a channel number. The created channel number uses the frequency number as the main channel number and the program number as the sub-channel number. When using an authorized CableCARD, the channel numbers are determined by the cable company.</p>		

Inputs			
Description	Qty.	Signal Type	Input Specifications
Antenna/Cable input	2	RF	F connector, 75-ohm
HDMI (digital video/audio)	2	HDMI EIA-861B standard for digital audio and video	HDMI standard connector Video: 60 Hz: 480i, 480p, 720p, 1080i 24 Hz, 30 Hz, 60 Hz: 1080p Audio: PCM stereo Note: Not for use with personal computers.
Video/S-Video (one front, two rear)	3	NTSC 480i only	Video: RCA Pin Plug, 1.0 V p-p, 75 ohm S-Video: Four-Pin DIN Plug Y: 1.0 Vp-p 75-ohm C: 0.286 Vp-p (burst signal), 75-ohm
Component Video (Y/Pr/Pb)	2	EIA-770.1 & EIA 770.2 480i, 480p, EIA 770.3 720p and 1080i (video standards)	RCA Pin Plug (EIA-770.3 Standard Levels and Timing) Y: 1.0 Vp-p (includes sync), 75-ohm Pr: 700 mV p-p, 75-ohm Pb: 700 mV p-p, 75-ohm
Audio Inputs	8 pairs	analog left and right audio	RCA Pin Plug 500 mV (full scale), 43-k ohm
PC DVI-I Input	1	analog and digital video	VGA (640 x 480, 60 Hz) W-VGA (848 x 480, 60 Hz) SVGA (800 x 600, 60 Hz) W-SVGA (1064 x 600, 60 Hz) XGA (1024 x 768, 60 Hz) 1280 x 720, 60 Hz
		digital video only	SXGA (1280 x 1024, 60 Hz) 1920 x 1080 (24 Hz, 30 Hz, 60 Hz) WXGA (1360 x 768, 60 Hz)

Appendix B: Specifications, continued

Outputs		
Description	Qty.	Output Specifications
Video	1	Video: RCA Pin Plug 1.0 Vp-p, 75-ohm Signal Type: NTSC 480i only
Audio (Signal)	2 pairs	RCA Pin Plug, 500 mV rms \pm 200 mV (full scale) for analog sources, 1.5 Vrms \pm 0.5 Vrms (full scale) for digital sources.
Audio (Speakers)	2	Woofers, 5.5" x 2.2"

Digital Interfaces		
Digital Audio Output	1	RCA Pin Plug, Signal Type, Dolby Digital, PCM
IEEE 1394 (input/output) (2 rear)	2	IEEE 1394 Four-Pin-Type Terminal, S400

Physical Characteristics and Power Consumption					
Model	Dimensions (inches)			Weight	Power Consumption
	Height	Width	Depth		
LT-37131	26.8	36.0	13.35	58.8 lbs.	250 w
LT-46131	31.7	44.6	15.59	89.0 lbs.	350 w

Environmental Conditions	
Model	Operating Temperature
LT-37131	41° F ~ 95° F (5° C ~ 35° C)
LT-46131	41° F ~ 95° F (5° C ~ 35° C)

IEEE 1394 System Compatibility

- This television is designed to conform to IEEE 1394 AV/C Software standards in effect at the time of development. This networking and control technology is designed to provide high-performance digital connections and product control, making the product easier to use.
- Mitsubishi D-VHS VCRs are fully compatible with this TV in audio, video, and control.
- As other manufacturers distribute products that use the IEEE 1394 AV/C standards, they will be responsible for developing products that meet the standards of the technology, as well as compatibility testing with other products. Mitsubishi cannot be responsible for their efforts, and therefore cannot promise compatibility with these other products. Any compatibility problems with other manufacturers' products should be brought to the attention of those manufacturers.

HDMI

The HDMI input is compliant with EIA-861B standards for standard, extended, and high-definition video; digital audio, and HDCP copy protection. The HDMI inputs on this TV are not intended for use with personal computers or devices outputting video signals with computer resolutions.

Appendix C: Troubleshooting

TV Reset Functions

You can resolve many common TV problems using the reset functions described in the following table. See also the additional troubleshooting suggestions later in this appendix.

IMPORTANT

Before you change sound or picture settings: If picture or sound settings seem wrong for a broadcast

channel (a channel from **ANT 1**, **ANT 2**, a cable box, or satellite receiver), first check other channels from the same input before changing settings. If most other channels from the same input seem correct, there is likely a problem with the broadcast rather than with the TV. Use care in this case, as changes you make to fix problems on individual channels also affect all other channels on the same input.

Reset Name	When to Use	How to Use	Resulting Action
Demo Mode Turn-Off	To turn off the retail demo mode slide show.	<ol style="list-style-type: none"> While viewing the TV, press MENU to display the TV Main menu with the Setup icon highlighted. Press ENTER to display the Setup menu. When the Setup menu is displayed, use ▶ to highlight the Demo Mode Off button and press ENTER. 	The demo mode will be turned off. The Demo Mode Off button in the setup menu will turn gray and be unselectable. The demo mode slide show cannot be turned on again.
Format	When the picture shape seems incorrect, use FORMAT to change the shape of the picture.	Press the FORMAT key to cycle through the available formats to find the best format for the current picture.	The last-used format for a signal type is memorized for each input. The next time the same input and the same signal type is viewed, the last-used format will be recalled.
PerfectColor™ (for the single input currently being watched)	When the color intensities seem out of balance, use PerfectColor resets to reset the color balances to the original factory settings.	<ol style="list-style-type: none"> While viewing the input to be reset, press VIDEO repeatedly to cycle to the PerfectColor™ option. Press ENTER to display the PerfectColor menu. Press CANCEL to reset the colors. 	All PerfectColor sliders are reset to the original center position. The PerfectColor settings for other inputs remain unchanged.
A/V Memory Reset (for the single input currently being watched)	When audio and/or video settings for a single input seem incorrect, use A/V Memory Reset to return the input to the original factory settings.	<ol style="list-style-type: none"> While viewing the input to be reset, press MENU to display the TV Main menu. Use ▶ to highlight the Audio/Video icon and press ENTER. When the Audio/Video menu is displayed with the AV Memory Reset text box highlighted, press ENTER to reset. Press EXIT to exit the menu. 	All Audio and Video settings for the individual input are reset except for the Listen To, Language, Audio Balance, and Closed Caption settings.
A/V Reset (for all inputs)	To reset audio and video adjustments for all inputs to the original factory settings.	While viewing the TV, press the front panel buttons GUIDE and FORMAT at the same time.	All Audio and Video settings are returned to the original factory settings, including Listen To and Language, plus Closed Captions settings and Format settings .
Channel Memorization	To erase and re-memorize channels on ANT 1 or ANT 2 .	<ol style="list-style-type: none"> While viewing the TV, press MENU to display the TV Main menu with the Setup icon highlighted. Press ENTER to display the Setup menu. When the Setup menu is displayed, use ▲ ▼ ◀ ▶ to highlight the antenna and reception mode button and press ENTER to start memorization. 	All previously memorized channels for the selected antenna input are erased and a new set of memorized channels is created. To add or delete individual channels, see the Channel Menu instructions in chapter 4, "TV Menu Settings."

Appendix C: Troubleshooting, continued

Reset Name	When to Use	How to Use	Resulting Action
Parental Lock Pass Code	To change your Parental Lock Pass Code	This information is listed on the cutout page in Appendix A. Please refer to that page.	Allows a new code to be established.
Front-Panel Lock Release	To re-enable the front-panel controls after activation of the Front-Panel Lock	<ul style="list-style-type: none"> When Energy Mode is set to Fast Power On, press and hold the MENU button on the front panel for over eight seconds. When Energy Mode is set to Low Power, press POWER on the front panel to turn on the TV. Press and hold the MENU button on the front panel for over eight seconds. 	Allows the front panel to be unlocked if the remote control is misplaced.
System Reset	If the TV does not turn on or off, does not respond to the remote control or front panel buttons, or has audio but no video.	Press the SYSTEM RESET button on the front panel with a pointed object such as the point of pencil or end tip of a paperclip.	The TV will turn off and the green LED will flash quickly for about one minute. When the blue LED stops flashing, you may turn on the TV. The changes you made most recently, before using SYSTEM RESET , may be lost. Changes you made previously, however, are not lost.
TV Reset IMPORTANT: Use this reset only if all other resets have been unsuccessful.	To reset all consumer-accessible settings and all memories to the original factory defaults. CAUTION: All owner-performed setups and adjustments will be erased.	<ol style="list-style-type: none"> While viewing the TV, press MENU to display the TV Main menu. With the Main menu displayed, press number keys 1 2 3 to display the Reset Menu. READ THE ON SCREEN WARNING AND INSTRUCTIONS. <ul style="list-style-type: none"> If you do not wish to use this reset, press EXIT or MENU to back out. If you do wish to use the reset, press ENTER to erase all memories and settings. 	The TV will start the initialization process. The TV will then turn off and the front blue LED will start flashing. When the LED stops flashing, you can turn the TV on again. The Parental Lock Access code will remain unaffected, but all other memories and settings outlined in this Owner's Guide will need to be set again.

Service and Support

Service

If you are unable to correct a problem with your TV, consult your Mitsubishi dealer or Mitsubishi Consumer Relations at (800) 332-2119.

- DO NOT adjust any controls other than those described in this Owner's Guide.
- DO NOT remove the protective back cover of your TV.

Support

- To order replacement or additional remote controls or Owner's Guides, visit our website at www.mitsubishiparts.com or call (800) 553-7278.
- For questions:
 - Call Consumer Relations at 800-332-2119.
 - E-mail: MDEAservice@mdea.com
 - Website: www.mitsubishi-tv.com

Appendix C: Troubleshooting, continued

General TV Operation		
	Symptom	Remarks
1.	The TV remote control does not work.	<ul style="list-style-type: none"> • Check that the batteries are installed correctly. • Check that the slide switch is set to TV. • Be no more than 20 feet from the TV when using the remote control. • Program the remote control to operate the TV or other device (see chapter 5).
2.	TV does not respond to the remote control or to front panel control and TV will not power on or off.	Use the System Reset button.
3.	When a device is selected from the Input Selection menu, the screen is blue (no signal source).	<ul style="list-style-type: none"> • Make sure the selected device is turned on. • Begin play of the VCR.
4.	Devices are grayed out in the Input Selection menu or the Split Screen Input Selection menu.	<ul style="list-style-type: none"> • A recording is in progress. Cancel the recording to select the device. • PCs and HDMI 1080p devices cannot display in the Split Screen sub-picture.
5.	You have forgotten your Parental Lock pass code.	See Appendix A, Bypassing the Parental Lock.
6.	Rating restrictions are not working.	Open the Parental Lock menu and: <ul style="list-style-type: none"> • Verify that the U.S. Ratings or Other Ratings setting is On. • Check the Lock Time/Unlock Time to check if rating restrictions are disabled. • Rating restrictions apply only to content on ANT 1 and ANT 2, INPUT 1–3, and IEEE 1394 inputs.
7.	On-screen displays appear each time you change a function.	Normal TV operation.
8.	Cable provider needs information to start CableCARD™ service.	On the remote control, press MENU and then enter the numbers 999 to display the Host ID and CableCARD™ ID information.
9.	The TV remote POWER button blinks <i>five</i> times.	Batteries in the remote control are low and should be replaced.

TV Channels		
	Symptom	Remarks
1.	The TV takes several seconds to respond to channel changes.	<ul style="list-style-type: none"> • It is normal for digital channels to take longer to tune in. • Press ENTER after a channel number to avoid delays. • Use a 4-digit number for an over-the-air digital channel. • Use a 6-digit number for digital cable channels if your cable service is able to recognize 6-digit channel numbers.
2.	You cannot access a channel.	<ul style="list-style-type: none"> • Use number keys instead of CH \wedge/\vee. • Be sure the channel you want to view is in memory. See “Channel Menu” in chapter 4, “TV Menu Settings.” • Check that the TV is turned to the correct device or antenna for that channel by pressing the INPUT button. • Make sure the Parental Lock is off. • If you cannot tune to a virtual digital channel even though the TV has already memorized digital channels, tune to the actual (physical) channel number used by the broadcaster. The virtual channel will then be automatically added to memory.
3.	Name options are not available for some channels.	Only memorized analog channels can be named.
4.	When ChannelView™ list is displayed, information appears incomplete	Available information is sent from the broadcaster or cable provider. No other data is available.

Appendix C: Troubleshooting, continued

TV Power On/Off		
Symptom		Remarks
1.	TV takes an excessively long time to power on.	<ul style="list-style-type: none"> When switched on, the TV needs time to boot up, just as a computer does. TV Energy Mode is set to Low Power. To change TV Energy Mode to Fast Power On: Press MENU, open the Setup menu, highlight the Fast Power On radio button, press ENTER.
2.	You cannot program the TV to turn on automatically (Timer function)	<ul style="list-style-type: none"> The TV may be locked. The clock may not be set. A time-delayed recording may have started. TV Energy Mode is set to Low Power. Change to Fast Power On in Setup menu.
3.	The TV will not turn on after being plugged in.	If blue light on front panel is blinking, wait for at least one minute for the light to turn off, then press POWER again.
4.	TV turned itself off and the light on the front panel started to blink.	<ul style="list-style-type: none"> Momentary power fluctuation caused the TV to turn off to prevent damage. Wait for the blue light to stop flashing and turn on again. If the TV does not stay turned on, use the System Reset button on the front panel. If this happens frequently, obtain an AC line power conditioner/surge protector. An unusual digital signal may have been received, triggering a protection circuit. Wait for the light to stop flashing and turn TV on.
5.	TV will not power off.	Use the System Reset button.

Picture		
Symptom		Remarks
1.	Picture does not look like a high-definition picture.	Not all signals are high-definition signals. To receive high-definition programming from your cable or satellite provider, you must subscribe to the provider's high-definition service. Some over-the-air broadcasts are in high-definition and can be received with a high-quality antenna suited to your location.
2.	Split Screen does not display a sub-picture.	<ul style="list-style-type: none"> Make sure the Parental Lock is off. Not all inputs can be displayed as a sub-picture.
3.	CableCARD channel is not shown as Split Screen sub-picture when CableCARD channel is the main image.	CableCARD allows only one channel at a time to be used.
4.	There is a large black or gray rectangle on the screen.	The TV's analog closed captioning has been set to "text" mode in the Captions menu. Turn off because there is no text information being broadcast.
5.	You cannot view a picture when playing a VHS tape.	Check your VCR's owner's guide for further troubleshooting.
6.	When viewing a stopped VCR, white lines are rolling on the screen.	<ul style="list-style-type: none"> Turn off video mute for the VCR. Begin playing the tape. Change the VCR input to the antenna input.

Appendix C: Troubleshooting, continued

Picture		
	Symptom	Remarks
9.	DVCR analog/digital problems.	If the tape is currently playing but no picture displays, there may be a mismatch of the media with the display. Press INPUT to display the Input Selection menu. Press ENTER for the DVCR device. If digital is selected, try analog, or if analog is selected, try digital.

Indicators		
	Symptom	Remarks
	Status indicator light is a steady/flashing red.	Service is required. Contact your dealer or a Mitsubishi Authorized Service Center to arrange for a service evaluation. Listings of Mitsubishi Authorized Service locations can be obtained from our web site, www.mitsubishi-tv.com or by calling 1-800-332-2119.

Sound		
	Symptom	Remarks
1.	There is no sound even when the volume is turned up.	<ul style="list-style-type: none"> • Check if the MUTE button is on. • The TV's "Listen to:" setting may be set to SAP. • Check that the TV Speakers setting is On in the Audio/Video menu. • If using an IEEE 1394 amplifier, check audio source in Input Selection menu. • Perform System Reset.
2.	The sound does not match the screen picture.	<ul style="list-style-type: none"> • The TV's Listen to: setting may be set to SAP. • If using stereo or A/V receiver speakers, check their input selection. • If using stereo or A/V receiver, check that AUDIO OUTPUT LEFT/RIGHT or DIGITAL AUDIO OUTPUT on TV's back panel is connected to the A/V receiver.

IEEE 1394 Recording		
	Symptom	Remarks
1.	Program to be recorded was correctly selected from ChannelView, however, incorrect program was recorded.	The broadcaster supplied program information that was incorrect and/or was changed after a recording was added to the Record List.
2.	Incomplete ChannelView program recorded.	Recording device may lack sufficient blank space to make a full recording.
3.	ChannelView program recording failed.	<ul style="list-style-type: none"> • Connection and compatibility issues with IEEE 1394 (FireWire®) digital devices. This may include too many Firewire devices in use at one time, or the recording device not understanding the record command. • Television lost power long enough to lose current clock time. • TV energy Mode was set to Low Power. Change TV Energy mode to Fast Power On. Press MENU, open the Setup menu, highlight the Fast Power On radio button, press ENTER.

Appendix C: Troubleshooting, continued

IEEE 1394 Recording	
Symptom	Remarks
4. Cannot record to or from the IEEE 1394 device, including dubbed recordings.	<ul style="list-style-type: none"> To initiate a recording to IEEE 1394 device, press the  (RECORD) key. The Record menu displays allowing setup of the recording. The source device for the recording is not powered on. When dubbing, the destination device for the recording is not powered on. The program is copy protected. The program has already been recorded once and the copy protection only allows one recording. Unapproved source device for copy protected material. The recording device can not decode the copyright signal included in the signal source (try another device if available). The playing device (for dubbing) does not support copy-righted material. Source for recording is copyrighted Too many IEEE 1394 devices in network. Insufficient bandwidth available. Disconnect unused devices. Source Device has higher speed (S 400) than record device. If possible, reverse devices, play in the slower device and record in the faster device.

IEEE 1394 Devices	
Symptom	Remarks
1. Excessive digital artifacts appear when viewing an IEEE 1394 device.	<ul style="list-style-type: none"> The IEEE 1394 cable is too long; 15 feet between devices is the maximum. There may be a slow device in the middle of the IEEE 1394 network. Move the slow devices to the end so that connections for faster devices do not pass through them.
2. D-VHS recordings for digital cable have drop-outs (loss of picture or sound), or no playback.	Digital cable signals on IEEE 1394 can exceed the data rate standards supported by DVCR.
3. There is no audio and video from the IEEE 1394 device.	<ul style="list-style-type: none"> The device is not turned on. Turn the device power on. No media (tape or disc) is inserted into the device. The media is blank (has no recording). The play command failed - Try pressing play again on the device's remote control or front panel. The device is already in use (for example, the device is currently recording). The source is copy-protected or violates copy protection. The device's digital video signal is not supported by the TV, as may be the case with an IEEE 1394 signal from a computer. Use analog connections instead, if available. The device is not an audio/video device. Too many other devices are already communicating over IEEE 1394. Remove or stop some devices and try again.
4. The IEEE 1394 Device is no longer listed in the Input Selection menu.	<ul style="list-style-type: none"> The IEEE 1394 plug is disconnected or loose. The IEEE 1394 device has not been powered on. Turn on. The device has not been discovered. The device is not an audio/video device

Appendix C: Troubleshooting, continued

IEEE 1394 Devices		
	Symptom	Remarks
5.	The IEEE 1394 device cannot be selected (is grayed out).	The device may be busy with a recording. Cancel the recording.
6.	When the Input Selection Menu is displayed, a menu does not display when I press the MENU button.	<ul style="list-style-type: none"> • The IEEE 1394 device does not provide a menu. • The TV cannot support IEEE 1394 menus.
7.	All IEEE 1394 devices disappear.	<ul style="list-style-type: none"> • The connected devices must not be in a loop that returns to the TV. Make sure a device is connected at the end. • Disconnect all the cables and devices from the TV. Replace them one by one to locate the problem device or cable. • Use System Reset (front control panel).
8.	Cannot rediscover a deleted IEEE 1394 device.	The device has been disconnected. Plug it in.
9.	An IEEE 1394 device has been plugged in but does not appear in the Input Selection menu (not discovered).	<ul style="list-style-type: none"> • The IEEE 1394 connection to the TV or another device is not secure or is loose. • The IEEE 1394 device is not powered on. • A device in the IEEE 1394 chain is not powered on. Turn on all the devices. • The device discovery can take as long as a minute to initiate. • IEEE 1394 cable is too long (maximum of 15 feet between devices). • The IEEE 1394 device uses an incompatible protocol and will not be discovered. • The TV can not decode DV video.
10.	Cannot view video from an IEEE 1394 DV camcorder.	Use analog connections for video and audio. You can still use the IEEE 1394 connection for control functions, however.
11.	An IEEE 1394 device is not responding properly.	<ul style="list-style-type: none"> • Unplug the device's power cord. Wait at least ten seconds and plug it in again. • Some IEEE 1394 devices are not supported by the TV because of incompatible standards.

Trademark and License Information

LICENSOR'S SUPPLIERS DO NOT MAKE OR PASS ON TO END USER OR ANY OTHER THIRD PARTY, ANY EXPRESS, IMPLIED OR STATUTORY WARRANTY OR REPRESENTATION ON BEHALF OF SUCH SUPPLIERS, INCLUDING, BUT NOT LIMITED TO THE IMPLIED WARRANTIES OF NON-INFRINGEMENT, TITLE, MERCHANTABILITY OR FITNESS FOR A PARTICULAR PURPOSE.

CableCARD™ is a trademark of Cable Television Laboratories, Inc.

DCR™ Certification Logo is a trademark of the Consumer Electronics Association.

Manufactured under license from Dolby Laboratories. Dolby is a trademark of Dolby Laboratories.

DTVLink™ Certification Logo is a trademark of the Consumer Electronics Association.

HDMI™ the HDMI logo and High-Definition Multimedia Interface are trademarks or registered trademarks of HDMI Licensing LLC.

This product incorporates copyright protection technology that is protected by U.S. patents and other intellectual property rights. Use of this copyright protection technology must be authorized by Macrovision, and is intended for home and other limited pay-per-view uses only unless otherwise authorized by Macrovision. Reverse engineering or disassembly prohibited.

This product includes technology owned by Microsoft Corporation and cannot be used or distributed without a license from Microsoft Licensing, Inc.

The  logo and the words "Simplay™" and "Simplay HD™," are the trademarks of silicon Image, Inc.

ChannelView™, ClearThought®, Diamond Shield™, MediaCommand™, NetCommand®, MonitorLink™, PerfectColor™, QuickView™, ViewPoint® are trademarks of Mitsubishi Digital Electronics America, Inc.

Mitsubishi TV Software

END-USER LICENSE AGREEMENT FOR EMBEDDED SOFTWARE

IMPORTANT – READ CAREFULLY: This License Agreement is a legal agreement between you (either an individual or an entity) and Mitsubishi Digital Electronics America, Inc. (MDEA) for all software pre installed and/or provided along with this television (“Software”). By utilizing this television and Software, you agree to be bound by the terms of this License Agreement.

The Software is protected by United States copyright laws and international treaty provisions, as well as other intellectual property laws and treaties. The Software is licensed, not sold.

1. **LICENSE GRANT.** MDEA grants you a non-exclusive, non-transferable, limited right and license to use one copy of the Software only with the Mitsubishi television model that included this owner’s guide and owned by you.

2. **RIGHTS AND LIMITATIONS.**

Software Not for Resale. You may not resell or otherwise transfer for value the Software, except in conjunction with a sale of the TV that Software has been pre installed.

Prohibition on Reverse Engineering, Decompilation and Disassembly. The Software contains trade secrets or other proprietary material in its human perceivable form and to protect them, you may not reverse engineer, decompile, or disassemble, or otherwise reduce the Software to any human perceivable form, except to the extent that the foregoing restriction is expressly prohibited by applicable law.

Separation of Components. The Software is licensed as a single product. Its component parts may not be separated for use on more than one TV.

No Rental. You may not rent, lease, lend, or sublicense the Software.

Trademarks. This License Agreement does not grant you any rights to any trademarks of MDEA.

3. **VIOLATIONS.** You understand that any use, copying or transfer of the Software, except as permitted pursuant to this License, may subject you to serious criminal and civil penalties including damages and an award to MDEA of attorneys’ fees in connection with any violation of this License. You further understand that you may be held legally responsible for any copyright infringement or other violation of intellectual property rights that is caused, encouraged, or induced by your failure to abide by the terms of the License. This license is effective until terminated, and will terminate immediately without notice from MDEA or judicial resolution if you fail to comply with any provision of this License.

4. **COPYRIGHT.** All title and intellectual property rights in and to the Software (including but not limited to any images, photographs, animations, video, audio, music, text, and “applets” incorporated into the Software), and any accompanying printed materials are owned by or licensed to MDEA. All title and intellectual property rights in and to the content which may be accessed through use of the Software is the property of the respective content owner and may be protected by applicable copyright or other intellectual property laws and treaties. This License Agreement grants you no rights to use such content, except that you own the media on which the Software is recorded, but MDEA and its licensors retain ownership of the Software itself. All rights not expressly granted are reserved by MDEA.

5. **EXPORT RESTRICTIONS.** MDEA is licensing the Software for use within the United States. You agree that you will not export or re-export the Software. You specifically agree not to export or re-export the Software: (i) to any country to which the U.S. has embargoed or restricted the export of goods or services, which currently include, but are not necessarily limited to Cuba, Iran, Iraq, Libya, North Korea, Sudan, and Syria, or to any national of any such country, wherever located, who intends to transmit or transport the Software back to such country; (ii) to any person or entity who you know or have reason to know will utilize the Software in the design, development, or production of nuclear, chemical, or biological weapons; or (iii) to any person or entity who has been prohibited from participating in U.S. export transactions by any federal agency of the U.S. government. You warrant and represent that neither the BXA nor any other U.S. federal agency has suspended, revoked, or denied your export privileges.

6. **DISCLAIMER OF WARRANTY. EXCEPT AS OTHERWISE PROVIDED IN THIS LICENSE OR IN THE LIMITED WARRANTY APPLICABLE TO THE TV, MDEA MAKES NO OTHER WARRANTIES OF ANY KIND WHATSOEVER REGARDING THE SOFTWARE AND HEREBY EXPRESSLY DISCLAIMS ALL WARRANTIES OF ANY KIND WHATSOEVER, EXPRESS OR IMPLIED, WITH RESPECT TO THE SOFTWARE. ALL IMPLIED WARRANTIES, INCLUDING, WITHOUT LIMITATION, THE IMPLIED WARRANTIES OF MERCHANTABILITY AND FITNESS FOR A PARTICULAR PURPOSE ARE HEREBY EXPRESSLY DISCLAIMED BY MDEA. IN NO EVENT SHALL MDEA BE LIABLE TO YOU OR ANY THIRD PARTIES, IN CONTRACT, IN TORT OR OTHERWISE, FOR ANY DIRECT, INDIRECT, SPECIAL, INCIDENTAL OR CONSEQUENTIAL DAMAGES OF ANY KIND OR NATURE. BECAUSE SOME JURISDICTIONS DO NOT ALLOW THE EXCLUSION OR LIMITATION OF IMPLIED WARRANTIES, THE ABOVE LIMITATION MAY NOT APPLY TO YOU.**

7. **LIMITATION OF LIABILITY. MDEA SHALL NOT, UNDER ANY CIRCUMSTANCES BE LIABLE TO YOU OR ANY THIRD PARTIES FOR ANY DAMAGES OF ANY NATURE, WHETHER INDIRECT, SPECIAL, INCIDENTAL, CONSEQUENTIAL OR OTHERWISE, INCLUDING, BUT NOT LIMITED TO, ANY CLAIMS FOR LOST PROFITS, LOSS OF GOOD WILL OR EXPENDITURES MADE OR COMMITTED FOR IN RELIANCE ON THE CONTINUATION OF THIS LICENSE. YOU AGREE THAT NEITHER MDEA’S BREACH OF THIS LICENSE NOR ITS FAILURE TO REPAIR A DEFECT, ERROR OR BUG SHALL CONSTITUTE A FAILURE OF THE ESSENTIAL PURPOSE OF THIS LICENSE. BECAUSE SOME JURISDICTIONS DO NOT ALLOW THE EXCLUSION OR LIMITATION OF LIABILITY FOR CONSEQUENTIAL OR INCIDENTAL DAMAGES, THE ABOVE LIMITATIONS MAY NOT APPLY TO YOU. MDEA’S liability to you for direct damages for any cause whatsoever and regardless of the form of the action, will be limited to the money paid by you for the TV (based on fair market value of the TV) that caused the damages.**

8. **GENERAL.** This License Agreement will be governed by the laws of the State of California.

WARNING: This product contains chemicals known to the State of California to cause cancer and/or birth defects or other reproductive harm.

MITSUBISHI LCD FLAT PANEL HDTV LIMITED WARRANTY

MITSUBISHI DIGITAL ELECTRONICS AMERICA, INC. ("MDEA") warrants to the original purchaser of this **LCD Flat Panel HDTV** that if purchased from an authorized MITSUBISHI Audio/Video Dealer, should it prove defective by reason of improper workmanship and/or material:

a. Parts. All parts (except any software incorporated into this **HDTV** are warranted for a period of one year from the date of the original purchase at retail. We will repair or replace, at our option, any defective part without charge for the part. Parts used for replacement may be replaced with those of like kind and quality and may be new or remanufactured. Parts used for replacement are warranted for the remainder of the original warranty period.

b. Embedded Software. MDEA warrants that all software incorporated into this **HDTV** (the "Embedded Software") will perform in accordance with the functional description of Embedded Software in all material respects, but MDEA does not warrant that the Embedded Software is error-free. MDEA also does not warrant that the Embedded Software will be compatible under IEEE 1394 AV/C and HAVi software standards with products produced by any other manufacturer. The warranty contained in this section shall continue for a period of one year, from the date of the original purchase from the dealer. If, after prompt notice within the warranty period, MDEA determines that the Embedded Software has failed to perform in accordance with such functional description in all material respects and if such failure is not due to accident, misuse, modification or misapplication of the Embedded Software, then MDEA shall modify or replace the nonconforming Embedded Software at no charge to you, which at MDEA's sole discretion may be fulfilled by means of modification or replacement software contained on a replacement memory card for Customer installation. The foregoing shall be MDEA's sole obligation to you under this limited warranty. All rights under this limited warranty on the Embedded Software also subject to your compliance with the terms of the Software License Agreement applicable to this **HDTV**, and this limited warranty on the Embedded Software shall be null and void if the Embedded Software is modified or changed in any manner except as specifically authorized by MDEA.

c. Labor. For certain items that are designed to be replaced by the consumer, including (but not limited to) some Embedded Software, the consumer is solely responsible for any replacement labor. For all other parts, we will provide the labor for a warranty repair by an authorized MITSUBISHI service center without charge for one year from the original date of purchase at retail.

d. Notice. To obtain warranty service, you must notify an authorized MITSUBISHI service center of any defect within the applicable warranty time period.

BEFORE REQUESTING SERVICE, please review the TV owner's guide to insure proper installation and correct customer control adjustment. If the problem persists, please arrange for warranty service.

1. TO OBTAIN WARRANTY SERVICE:

a. Contact your nearest authorized MITSUBISHI service center whose name and address can be obtained from your MITSUBISHI dealer, by writing to the address provided below, calling MDEA at 800-332-2119, or using the support feature of our website at www.Mitsubishi-tv.com.

b. Warranty service will be provided in your home or, if required, at an authorized service shop, provided that your television is located within the geographic territory customarily covered by an authorized MITSUBISHI service center. If not, you must either deliver your television to an authorized service location at your own expense, or pay for any travel and/or transportation costs the service center may charge to and from you home. Actual service labor will be provided without charge.

c. Proof of purchase date from an authorized MITSUBISHI dealer is required when requesting warranty service. Present your sales receipt or other document which establishes proof and date of purchase. **THE RETURN OF THE OWNER REGISTRATION CARD IS NOT A CONDITION OF WARRANTY COVERAGE.** However, please return the Owner Registration Card so that we can contact you should a question of safety arise which could affect you.

2. THIS LIMITED WARRANTY DOES NOT COVER:

a. Up to .01% pixel outages (small dot picture elements that are dark or incorrectly illuminated).

b. Cosmetic damage or any other damage where such damage is caused by unauthorized modification, alteration, repairs to or service of the product by anyone other than an authorized

MITSUBISHI service center; physical abuse to or misuse of the product (or any product damaged by excessive physical or electrical stress); any products that have had a serial number or any part thereof altered, defaced or removed; product use in any manner contrary to the Owner's Guide; freight damage; or any damage caused by acts of God or other factors beyond the reasonable control of MDEA, such as power surge damage caused by electrical system or damages caused by use of third party mounting brackets or stands. This limited warranty also excludes service calls where no defect in the product covered under this warranty is found, service calls related to unsatisfactory audio or visual reception or signal unless caused by a defect in the product that is covered under this limited warranty, all costs, expenses or any other damages arising from product installation, removal from or re-installation into custom installations or on wall mountings, or set-ups, any adjustments of user controls (including contrast, brightness, color, tint, fine tuning, sharpness), other adjustment necessary to prepare the unit for display or use, connection with any external audio receiver, antenna, cable or satellite systems, or service of products purchased or serviced outside the U.S.A. Please consult the operating instructions contained in the Owner's Guide furnished with the product for information regarding user controls.

3. ANY EXPRESS WARRANTY NOT PROVIDED HEREIN, AND ANY REMEDY WHICH, BUT FOR THIS PROVISION, MIGHT ARISE BY IMPLICATION OR OPERATION OF LAW, IS HEREBY EXCLUDED AND DISCLAIMED. THE IMPLIED WARRANTIES OF MERCHANTABILITY AND OF FITNESS FOR ANY PARTICULAR PURPOSE ARE EXPRESSLY LIMITED TO A TERM OF ONE YEAR.

4. UNDER NO CIRCUMSTANCES SHALL MDEA BE LIABLE TO PURCHASER OR ANY OTHER PERSON FOR ANY INCIDENTAL, SPECIAL OR CONSEQUENTIAL DAMAGES, WHETHER ARISING OUT OF BREACH OF WARRANTY, BREACH OF CONTRACT, OR OTHERWISE.

5. Some states do not allow limitations on how long an implied warranty lasts, or the exclusion or limitation of incidental, special, or consequential damages, so the above limitations or exclusions may not apply to you.

6. This limited warranty gives you specific legal rights, and you may also have other rights which vary from state to state.

In no event shall Mitsubishi have any liability, including without limitation, for general, consequential, incidental, or special damages for loss, destruction, damage or corruption of recorded data, media or software resulting from use of this television, or cost of recovery of lost data, media or software therefore.



Index

A

- A/V Discs 87
- A/V Memory Reset. *See* Reset
- A/V Receiver
 - Connecting 32
- A/V Reset. *See* Reset
- Adjust Keys (Up/Down/Left/Right) 36, 46
- Anamorphic Picture Format
 - DVD Definitions 40
- Antenna
 - Adjusting and the Signal Strength Meter 51
 - Connecting 28
- Antenna Inputs (ANT 1/MAIN, ANT 2/AUX) 18
- Audio/Video Menu 47, 59
- Audio Settings 60
- Auto Input Sensing 22

B

- Back Panels 19
- Batteries. *See* Remote Control

C

- CableCARD™ 13, 17, 20, 48
- Cable Box
 - and the Remote Control 36, 64, 86
 - Connecting 26, 30, 33
 - IEEE 1394 82
- Cable Management 25
- Camcorder
 - Connecting (Analog) 33
 - DV (Digital Video) 83, 101
 - IEEE 1394 Camcorders 83
 - Power 82
- Captions Menu 47, 53
- Channels. *See also* FAV
 - and TV Timer 49
 - Changing 14
 - Digital Channel Numbers 93
 - Memorizing 48
 - Naming 51
 - Status Display 39
- ChannelView™ Channel Listings 38
- Channel Menu 47, 51
- Cleaning 7
 - LCD Screen 7
- ClearThought® Auto Input Sensing 22
- ClearThought Auto Input Sensing 12
- Clock, Set Date and Time 48
- Closed Captions. *See* Captions Menu
- Color Adjustments 61
- Component Inputs (Y Pb Pr) 18
- Computer. *See* Personal Computer

- Computer Icon, Removing the 76
- Connection Types 23
- Copy Restrictions 87
 - and Status Display 39

D

- Date. *See* Clock
- Daylight Savings Time 48
- Demo Mode, turning off 95
- Digital Audio Out 20
- Dolby Digital 20, 32, 94
 - and IEEE 1394 82
- DTVLink™ 20
- DV 83
- DVDs
 - and the Remote Control 36, 64
 - and V-Chip Ratings 58
- DVD Player with Component Video,
 - Connecting 32
- DVI Device, Connecting 31
- DVI Jack (for Personal Computer) 20

E

- Energy Mode 49

F

- Fast Power On (Energy Mode) 49
- FAV 52
- Film Mode 59
- FireWire®. *See* IEEE 1394
- Freeze Picture. *See* Pause
- Front Panel 15
- Front Panel Lock 55
- Full Spectrum Color 12

G

- GUIDE Key (button) 36

H

- HDMI
 - HDMI Device 31
 - HDMI Inputs 12
 - HDMI Jack, Description 20
 - Personal Computer with HDMI Output 77
- HDTV Receiver with Component Video, Connecting 26
- HD (High-Definition Signal) 40

I

- Icon Order Menu 47, 50
- IEEE 1394 Devices
 - Amplifier Settings 60
 - and Analog Outputs 22, 88
 - and Recording 84
 - and Status Display 39

- Compatible IEEE 1394 Devices 82
- Connecting IEEE 1394 Devices 83
 - Inputs on TV 20
 - TV Connection Speed 83
- Important Information About Your TV 6
- INFO Key Status Display 39
- Input Jacks on TV (Standard Audio/Video) 18
- Input Name Menu 47, 50
- Input Selection Menu
 - Remove the Computer Icon from the Input Selection Menu 76

L

- Language
 - Audio Setting (Digital Channels) 60
 - for TV Menus 48
- LED Indicator Lights
 - POWER/TIMER Indicator 16
 - STATUS Indicator 16
- Lock by Time 55
- Lock TV. *See* Parental Lock
- Low Power (Energy Mode) 49

M

- Memorizing Channels 48
- MONITOR OUT Jacks 19
- Mute
 - Audio
 - and Closed Captions 53
 - and status Display 39
 - MUTE key 36
 - Video Mute 59

N

- Noise Reduction (Video) 61

P

- Parental Lock
 - Bypassing 91
 - Front Panel Lock 55
 - V-Chip Ratings 58
- Pass Code
 - Resetting 91
 - Setting 55
- PAUSE Key 36
- PC Icon, Removing the. *See* Computer Icon
- PerfectColor 61
- Personal Computer 83
 - Connecting 77
 - Remove the Computer Icon 76
 - Setup 76

- Picture Formats, TV 40
 - Picture Format Definitions 40
 - Picture Quality
 - and Connection Types 24
 - and Film Mode 59
 - Troubleshooting 98
 - Power Consumption 49, 94
 - Power On/Off 98
 - Power Swivel. *See* Swivel, Manual and Power
- Q**
- QV (QuickView™) 36
- R**
- Recording
 - and MONITOR OUT Jacks 19
 - Cancelling Recordings
 - IEEE 1394 devices 85
 - Recording Setup Menu
 - and IEEE 1394 Devices 84
 - RECORD Button 100
 - Record List
 - and IEEE 1394 Devices 84
 - Signals Available for Recording 23
 - Remote Control
 - Batteries 37
 - Keys and Functions 36
 - Low Battery Indicator 37
 - Programming Codes (reference chart) 66
 - Programming Instructions 65
 - Reset 37
 - Reset
 - A/V (all settings) 15
 - A/V Memory (for individual devices) 59
 - DVCR Counter 86
 - Pass Code 91
 - PerfectColor 61
 - Remote Control 37
 - System Reset Button 95
 - Reset Functions, TV 95
- S**
- S-Video
 - Connecting 26
 - Connector Illustration 24
 - Safeguards 8
 - SAP (Second Audio Program) 60
 - Satellite Receiver
 - and the Remote Control 64
 - Connecting 26
 - IEEE 1394 86
 - SD (Standard-Definition Signal) 40
 - Search A/V Disc. *See* A/V Discs
 - Service and Support 96
 - Setup Menu 47, 48
 - Side Panel 20
 - Signals
 - 1080p 40
 - 480i 40
 - 480p 40
 - 720p and 1080i 40
 - Signal Definitions 40
 - Sleep Timer 37
 - Speakers, Turning TV Speakers On or Off 59
 - Specifications, TV 93
 - Split Screen
 - Description 42
 - Standard-Definition Signal 40
 - Stand Removal Instructions 10
 - Stand Requirement 6
 - Status Display 39
 - STATUS Indicator. *See* LED Indicator Lights
 - Stereo System. *See* A/V Receiver
 - Swivel, Manual and Power 12, 36, 44
 - System Reset 15, 96
- T**
- 3:2 pulldown 59
 - Time. *See* Clock
 - Timer (TV Timer) 49
 - Time Zone. *See* Clock
 - Troubleshooting 95
- V**
- VCR
 - Connecting 18, 29, 30
 - IEEE 1394 82
 - Troubleshooting 98
 - Video Noise Reduction 61
 - Video Settings 61
 - Viewing Device. *See* Input Selection Menu
- W**
- Wall Outlet Cable 27



Website:
www.mitsubishi-tv.com

E-mail:
MDEAservice@mdea.com

**For questions, call Consumer Relations at
800-332-2119**

**To order replacement or additional
remote controls or Owner's Guides:**

visit www.mitsuparts.com

or call 800-553-7278

Demo Mode

This TV has a demo mode for use in retail stores. Demo mode causes the TV to display a series of screens outlining the TV's features.

To turn off demo mode:

1. Press **MENU**.
2. When the Main menu appears with **Setup** high-lighted, press **ENTER**.
3. When the Setup menu opens, press **▶** to high-light the on-screen **Demo Mode Off** button.
4. Press **ENTER**.

System Reset

If the TV does not respond to the remote control, front panel controls, or will not power on/off, press the **SYSTEM RESET** button on the front panel with a pointed object, such as the point of a pencil or end tip of a paperclip.

The green LED will flash quickly for about one minute. When the green LED stops flashing, you may turn on the TV.