

# LCD User's Guide

Changing Entertainment. Again.

## Find Inside:

- *Connections* ..... page 6
- *Remote*..... page 18
- *Features* ..... page 19
- *Menus* ..... page 26
- *FAQs*..... page 34
- *Troubleshooting* ..... page 35



[rca.com/television](http://rca.com/television)

# Important Information

## CAUTION

RISK OF ELECTRIC SHOCK  
DO NOT OPEN

Caution: To reduce the risk of electric shock, do not remove cover (or back). No user serviceable parts inside. Refer servicing to qualified service personnel.



This symbol indicates "dangerous voltage" inside the product that presents a risk of electric shock or personal injury.



This symbol indicates important instructions accompanying the product.

## WARNING

To reduce the risk of fire or electric shock, do not expose this product to rain or moisture. The apparatus shall not be exposed to dripping or splashing. No objects filled with liquids, such as vases, shall be placed on the apparatus.

## WARNING

The TV is unstable until it is properly attached to the base or mounted to the wall. Please follow the base or wall mounting instructions provided in the User's Guide to ensure your safety.



This symbol indicates that this product contains mercury. Special disposal of this product for environmental reasons may be required under the laws applicable to your jurisdiction. For disposal or recycling information, please contact your local authorities or the Electronic Industries Alliance: [www.eiae.org](http://www.eiae.org).

Refer to the identification/rating label located on the back panel of your product for its proper operating voltage.

FCC Regulations state that unauthorized changes or modifications to this equipment may void the user's authority to operate it.

**Cable TV Installer:** This reminder is provided to call your attention to Article 820-40 of the National Electrical Code (Section 54 of the Canadian Electrical Code, Part 1) which provides guidelines for proper grounding and, in particular, specifies that the cable ground shall be connected to the grounding system of the building as close to the point of cable entry as practical.

**Important:** This television is a table model and is designed to sit on a firm, flat, surface. Don't place the TV on soft carpeting or similar surface because the ventilation slots on the bottom of the unit will be blocked resulting in reduced lifetime from overheating. To assure adequate ventilation for this product, maintain a spacing of 4 inches from the top and sides of the TV receiver and 2 inches from the rear of the TV receiver and other surfaces.

Also, make sure the stand or base you use is of adequate size and strength to prevent the TV from being accidentally tipped over, pushed off, or pulled off. This could cause personal injury and/or damage the TV. Refer to the Important Safety Instructions on the next page.

## Product Registration

Please fill out the product registration card (packed separately) and return it immediately. For US customers: Your RCA Consumer Electronics product may also be registered at [www.rca.com/productregistration](http://www.rca.com/productregistration). Registering this product allows us to contact you if needed.

## Product Information

Keep your sales receipt to obtain warranty parts and service and for proof of purchase. Attach it here and record the serial and model numbers in case you need them. These numbers are located on the product.

Model No. \_\_\_\_\_ Serial No. \_\_\_\_\_ Purchase Date \_\_\_\_\_

Dealer/Address/Phone \_\_\_\_\_

## Important Safety Instructions

### Important Safety Instructions

1. Read these instructions.
2. Keep these instructions.
3. Heed all warnings.
4. Follow all instructions.
5. Do not use this apparatus near water.
6. Clean only with dry cloth.
7. Do not block any ventilation openings. Install in accordance with the manufacturer's instructions.
8. Do not install near any heat sources such as radiators, heat registers, stoves, or other apparatus (including amplifiers) that produce heat.
9. Do not defeat the safety purpose of the polarized or grounding-type plug. A polarized plug has two blades with one wider than the other. A grounding type plug has two blades and a third grounding prong. The wide blade or the third prong is provided for your safety. If the provided plug does not fit into your outlet, consult an electrician for replacement of the obsolete outlet.
10. Protect the power cord from being walked on or pinched particularly at plugs, convenience receptacles, and the point where they exit from the apparatus.
11. Only use attachments/accessories specified by the manufacturer.
12. Use only with the cart, stand, tripod, bracket, or table specified by the manufacturer, or sold with the apparatus. When a cart is used, use caution when moving the cart/apparatus combination to avoid injury from tip-over.
13. Unplug this apparatus during lightning storms or when unused for long periods of time.
14. Refer all servicing to qualified service personnel.



Servicing is required when the apparatus has been damaged in any way, such as power-supply cord or plug is damaged, liquid has been spilled or objects have fallen into the apparatus, the apparatus has been exposed to rain or moisture, does not operate normally, or has been dropped.

15. If an outside antenna or cable system is connected to the product, be sure the antenna or cable system is grounded so as to provide some protection against voltage surges and built-up static charges. Section 810 of the National Electrical Code, ANSI/NFPA No. 70-1984 (Section 54 of Canadian Electrical Code, Part 1) provides information with respect to proper grounding of the mast and supporting structure, grounding of the lead-in wire to an antenna-discharge unit, size of grounding conductors, location of antenna-discharge unit, connection to grounding electrodes, and requirements for the grounding electrode. See following example.

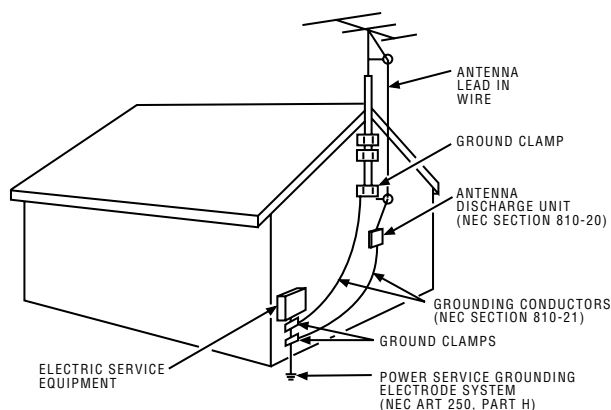

# Table of Contents

---

Important Safety Instructions .....	i
-------------------------------------	---

## Chapter 1: Connections and Setup

<b>Things to Consider Before You Connect</b> .....	5
Protect Against Power Surges.....	5
Protect Devices from Overheating .....	5
Position Cables Properly to Avoid Audio Interference .....	5
Use Indirect Light.....	5
Check Supplied Parts .....	5
<b>Get the Picture</b> .....	6
Receiving Digital Channels.....	6
Receiving Analog Channels.....	6
<b>Choose Your Connection</b> .....	7
Video Connection .....	8
HDMI/DVI Connection .....	10
VGA Connection .....	12
<b>Plug in the TV</b> .....	13
<b>Put Batteries in the Remote</b> .....	13
<b>Turn on the TV</b> .....	13
<b>How to Use the Remote Control to Complete the Initial Setup</b> .....	13
<b>Complete the Initial Setup</b> .....	14
Set the Menu Language .....	14
Complete Channel Setup .....	14
<b>What To Expect</b> .....	15
Watching TV.....	15
Changing Channels.....	15
<b>Explanation of Jacks (in alphabetical order)</b> .....	16
<b>Buttons and Other Jacks On Your TV</b> .....	17
Front Panel Buttons.....	17
Right Side Input Jacks (when facing back of TV)	17
<b>The Buttons on the Remote Control</b> .....	18

## Chapter 2: Using the TV's Features

<b>Channel Banner</b> .....	19
<b>Parental Controls and V-Chip</b> .....	20
How V-Chip Works for USA and Canada.....	20
Lock/Unlock Parental Controls.....	20
US V-Chip TV Ratings.....	21
Blocking Canadian V-Chip Ratings .....	22
V-Chip Movie Rating Limit .....	23

Block Channels.....	23
Block Digital Channels.....	23
Front Panel Block.....	24
Lock Time Menu.....	24
Blocking Unrated/Exempt Programs .....	24
Future Rating Region .....	24
<b>Additional Features</b> .....	25
MultiTask Audio.....	25
Calendar .....	25

## Chapter 3: Using the TV's Menu System

<b>Using the Menu System</b> .....	26
<b>Sound Menu</b> .....	26
<b>Picture Menu</b> .....	28
<b>Setup Menu</b> .....	30
<b>Parental Control Menu</b> .....	33
<b>Time Menu</b> .....	33

## Chapter 4: Other Information

<b>Frequently Asked Questions (FAQs)</b> .....	34
<b>Troubleshooting</b> .....	35
<b>Mounting Your TV to the Wall</b> .....	38
<b>V-Chip Rating Explanations</b> .....	39
US V-Chip Rating System .....	39
Canadian English V-Chip Rating System.....	39
Canadian French V-Chip Rating System .....	40
<b>Autotuning</b> .....	41
How to Set Up the Autotuning Feature.....	41
<b>Limited Warranty</b> .....	42
<b>Care and Cleaning</b> .....	43

## Things to Consider Before You Connect

### Protect Against Power Surges

- Connect all devices before you plug any of their power cords into the wall outlet or power strip. NEVER plug your TV into an outlet that is controlled by a wall switch.
- Turn off the TV and/or device(s) before you connect or disconnect any cables.
- Make sure all antennas and cables are properly grounded. Refer to the Important Safety Instructions sheet packed with your TV.

### Protect Devices from Overheating

- Don't block ventilation holes on any of the devices. Arrange the devices so that air can circulate freely.
- Don't stack devices.
- If you place devices in a stand, make sure you allow adequate ventilation.
- If you connect an audio receiver or amplifier, place it on the top shelf so the heated air from it won't flow around other devices.

### Position Cables Properly to Avoid Audio Interference

- Insert each cable firmly into the designated jack.
- If you place devices above the TV, route all cables down the side of the back of the TV instead of straight down the middle.
- If your antenna uses 300-ohm twin lead cables, do not coil the cables. Also, keep the twin lead cables away from audio/video cables.

### Use Indirect Light

Don't place the TV where sunlight or room lighting will be directed toward the screen. Use soft or indirect lighting.

### Check Supplied Parts

Check that the following parts were packed with your product.

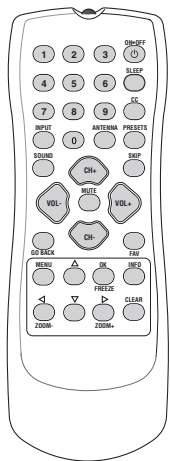

Remote control  
Part # R130A1

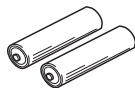

2 AA batteries

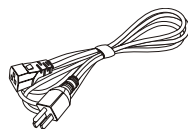

Power cord

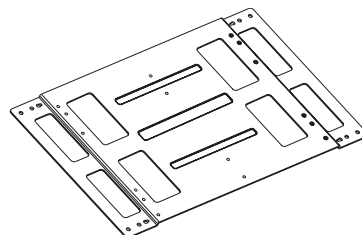

Wall mount plate (only  
available for model L26WD12)

**Note:** If you need to replace your remote, call 1-800-338-0376. A shipping and handling fee, and the appropriate sales tax, will be charged upon ordering. Have your Visa, MasterCard, or Discover Card ready.

# Connections and Setup

ANTENNA/CABLE  
ANALOG INPUT

ANTENNA/CABLE  
DIGITAL INPUT

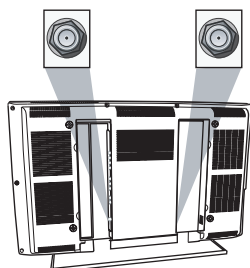

## Get the Picture

The first part of connecting your TV is to get the picture, or a signal. The back panel of your TV allows you to receive analog channels by using the ANTENNA/CABLE ANALOG INPUT and digital channels by using the ANTENNA/CABLE DIGITAL INPUT. See the graphic to the left for these locations.

## Receiving Digital Channels

### What You Need

- Antenna ("rabbit ears") or outdoor antenna with coaxial cable

OR

- Coaxial cable with cable box or satellite receiver ready to receive high-definition channels.
- A. Do you have an indoor or outdoor antenna? If not, go to step B. If so, plug the antenna or coaxial cable from the wall outlet into the ANTENNA/CABLE DIGITAL INPUT to receive free off-air local digital channels.
  - B. Do you have digital cable or satellite service? If so, plug the coaxial cable from the digital cable outlet into the ANTENNA/CABLE DIGITAL INPUT to receive your digital cable channels. Call the cable company to make sure you're signed up to receive high-definition channels.

### What You Need To Know

- Visit [www.antennaweb.org](http://www.antennaweb.org) to get help deciding what type of antenna to use to receive the local digital channels available to you. By entering where you live, this mapping program tells you what local analog and digital stations are available using a certain antenna.
- When you get to the *Channel setup* screen in the Initial Setup, make sure you set the options for using a digital signal source. To complete a channel search now, go to page 14.
- When you are ready to watch channels, make sure you are tuned to the Digital Input. Press the ANTENNA button to tune to the Digital Input (look for *D* at the bottom of your channel banner. Go to page 15 for more information).

## Receiving Analog Channels

### What You Need

- Antenna ("rabbit ears") or outdoor antenna with coaxial cable

OR

- Coaxial cable with cable or satellite service
- A. Do you have an indoor or outdoor antenna? If not, go to step B. If so, plug the antenna or coaxial cable from the wall outlet into the ANTENNA/CABLE ANALOG INPUT to receive free off-air local analog channels.
  - B. Do you have cable or satellite service? If so, plug the coaxial cable from the wall outlet into the ANTENNA/CABLE ANALOG INPUT to receive your cable channels.

### What You Need to Know

- Visit [www.antennaweb.org](http://www.antennaweb.org) to get help deciding what type of antenna to use to receive the local analog channels available to you. By entering where you live, this mapping program tells you what local analog and digital stations are available using a certain antenna.
- When you get to the *Channel setup* screen in the Initial Setup, make sure you set the options for using an analog signal source. To complete a channel search now, go to page 14.
- When you are ready to watch channels, make sure you are tuned to the Analog Input. Press the ANTENNA button to tune to the Analog Input (look for *A* at the bottom of your channel banner. Go to page 15 for more information).



Coaxial cable

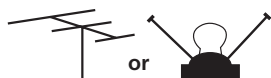

Outdoor or Indoor antenna



Coaxial cable

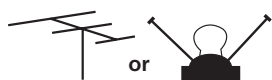

Outdoor or Indoor antenna

## Choose Your Connection

There are several ways to connect your TV. Please use the following chart to determine which connection is best for you. Proceed to the appropriate page and connect your TV.

*Note for US customers: If you prefer, we can provide you with the name of an Authorized Service Representative who will visit your home for a fee to install your electronic entertainment system and to instruct you in its operation. For details about this service, call 1-888-206-3359.*

*For additional assistance while using your RCA product, please visit [www.rca.com/customersupport](http://www.rca.com/customersupport).*

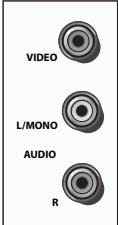
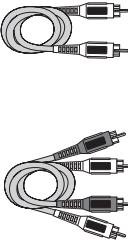
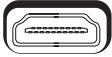
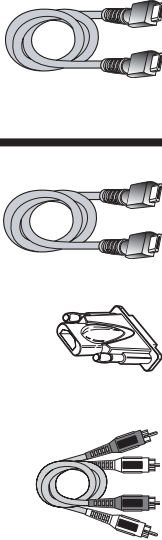
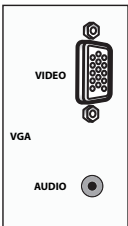
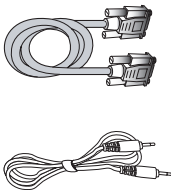
Jacks Used	Cables Needed	Go to...
 <p><b>Video</b></p> <p><b>Audio R and L/MONO</b></p> <p>These jacks are located on the right side of the TV when facing the back.</p>	 <p><b>Video</b></p> <p><b>Audio</b></p>	<p><b>page 8-9</b></p>
 <p><b>HDMI/DVI</b></p>	 <p><b>HDMI™</b></p> <p><b>OR</b></p> <p><b>HDMI</b></p> <p><b>+</b></p> <p><b>HDMI/DVI adapter</b></p> <p><b>+</b></p> <p><b>Audio</b></p>	<p><b>page 10-11</b></p>
 <p><b>VGA</b></p> <p><b>Audio</b></p>	 <p><b>VGA</b></p> <p><b>Audio</b></p>	<p><b>page 12</b></p>

HDMI, the HDMI logo, and High-Definition Multimedia Interface are trademarks or registered trademarks of HDMI Licensing LLC.

# Connections and Setup

## Video Connection

This is an example of a connection using the Video jack.

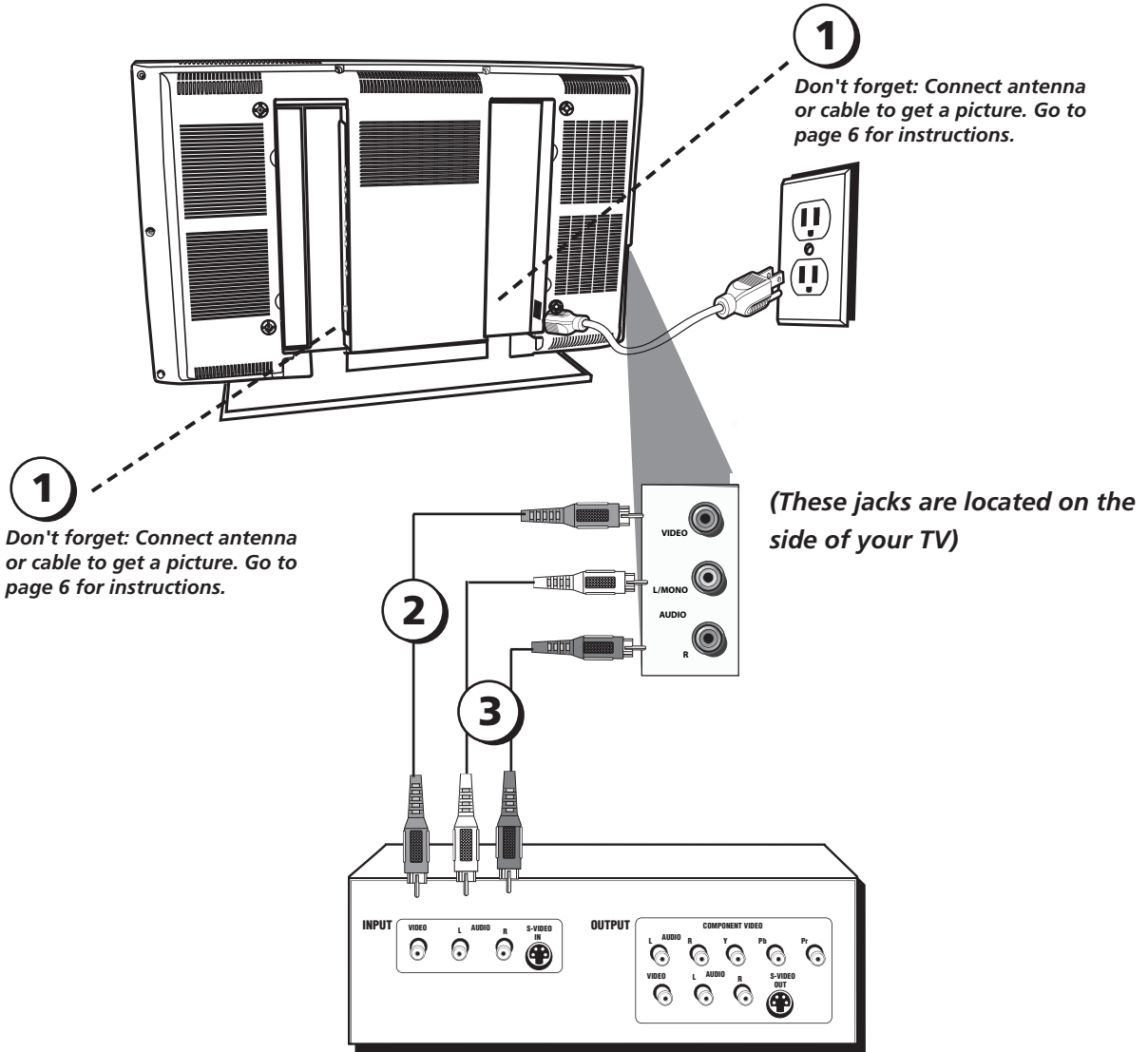



## Connecting the Device

This connection allows you to connect a device that has a Video Out jack, for example, a DVD player.

**Note:** If the device you're connecting also has Component Video jacks and you have component video cables, we recommend you use the COMPONENT VIDEO (CMP1 or CMP2) input for better quality. If you want to use that connection, you need to purchase three video cables or bundled component video cables.

Using the example of a DVD player:

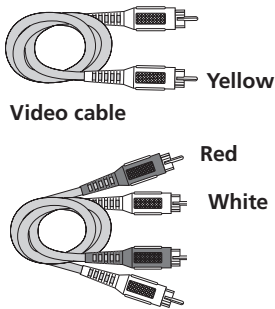

Video cable

Audio cables are color coded- Red= right audio; White= left audio

①. Connect your cable and/or off-air antenna as described on page 6.

②. Connect your yellow video cable to the side of the TV.

Connect a video cable to the VIDEO Input jack on the side of the TV and to the Video Output on the DVD player.

③. Connect your red and white audio cables to the side of the TV.

Connect the audio (red and white) cables to the AUDIO R and L/MONO jacks on the side of the TV and to the Audio Output jacks on the DVD player.

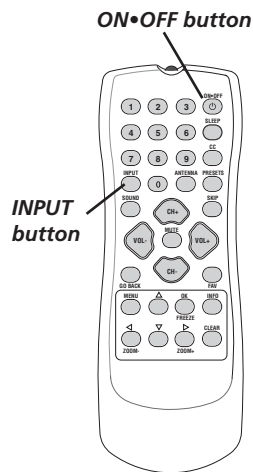

Use these buttons to view the picture of the device you've connected to the TV.

## Viewing the Picture from the Connected Device

The device in this connection is connected to the TV's VIDEO Input jack. To view this device:

1. Plug in the TV (see page 13 for details) and the device, if they aren't already plugged in.
2. Turn on the TV and the device you want to view, for example a DVD player.
3. Repeatedly press the INPUT button on the remote control to scroll through the Video Input Channels until you see VID displayed at the bottom of the TV's screen. To go back to viewing TV channels, press the ANTENNA button.

**Note:** If the picture from the DVD player appears black and white, you might be tuned to the wrong input. Make sure you press INPUT until you see VID displayed at the bottom of the TV's screen.

• If you're done connecting devices to your TV, go to page 14 to complete the Initial Setup.

• To continue connecting devices, go to the next page.

# Connections and Setup

## HDMI/DVI Connection

This is an example of a connection using the HDMI/DVI jack.

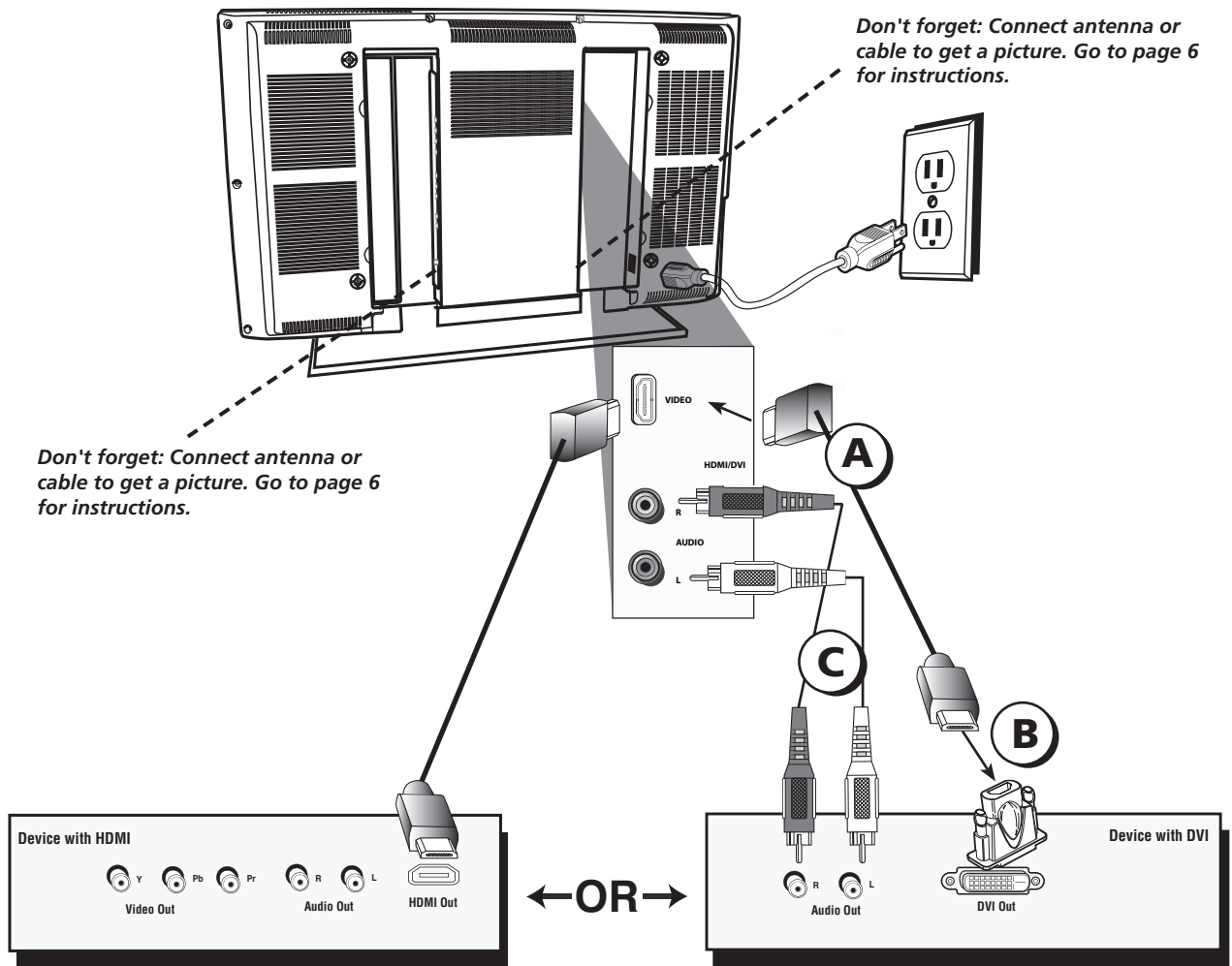

## Connecting the Device

High-Definition Multimedia Interface (HDMI) technology is an uncompressed digital connection that carries both video and audio data by way of an integrated mini-plug cable. Since HDMI technology is based on Digital Visual Interface (DVI), the jack on the back of your TV is also compatible with devices that have a DVI output jack.

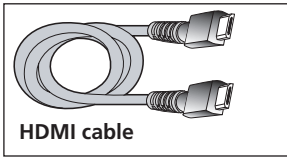

### Using the example of a set-top box:

- **If your set-top box has an HDMI jack, connect an HDMI cable.**

Connect an HDMI cable to the HDMI/DVI INPUT jack on the back of the TV and to the HDMI Out jack on the back of the device.

–OR–

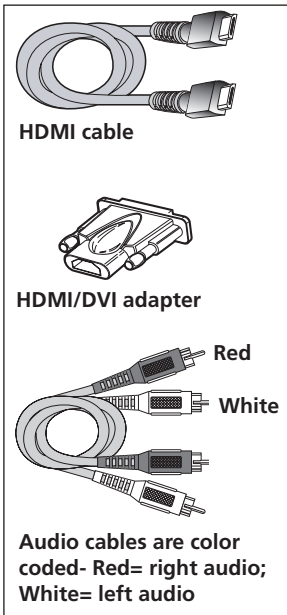

- **If your set-top box has a DVI jack, connect an HDMI cable and an HDMI/DVI adapter.**

- Connect an HDMI cable to the HDMI/DVI INPUT jack on the back of the TV.
- Attach an HDMI/DVI adapter to the end of the HDMI cable, then connect the adapter to the DVI Out jack on the set-top box.
- Since you're using an HDMI/DVI adapter, you need to connect Audio left and right cables to the HDMI/DVI R and L AUDIO jacks on the back of the TV and to the R and L jacks on the back of the device.

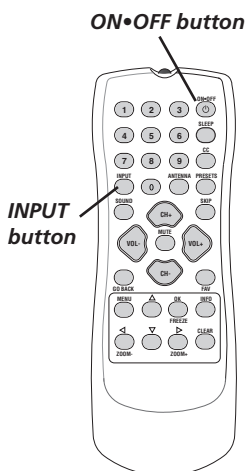

Use these buttons to view the picture of the device you've connected to the TV.

## Viewing the Picture from the Connected Device

The device in this connection is connected to the HDMI/DVI jack. To view this device:

1. Plug in the TV (see page 13 for details) and the device, if they aren't already plugged in.
2. Turn on the TV and the device you want to view, for example a set-top box.
3. Repeatedly press the INPUT button on the remote control to scroll through the Video Input Channels until you see *HDMI* displayed at the bottom of the TV's screen. To go back to viewing TV channels, press the ANTENNA button.

• If you are done connecting devices to your TV, go to page 14 to complete the Initial Setup.

• If you experience HDMI problems, go to the HDMI Troubleshooting section on page 36.

# Connections and Setup

## VGA Connection

This is an example of a connection using the VGA jacks.

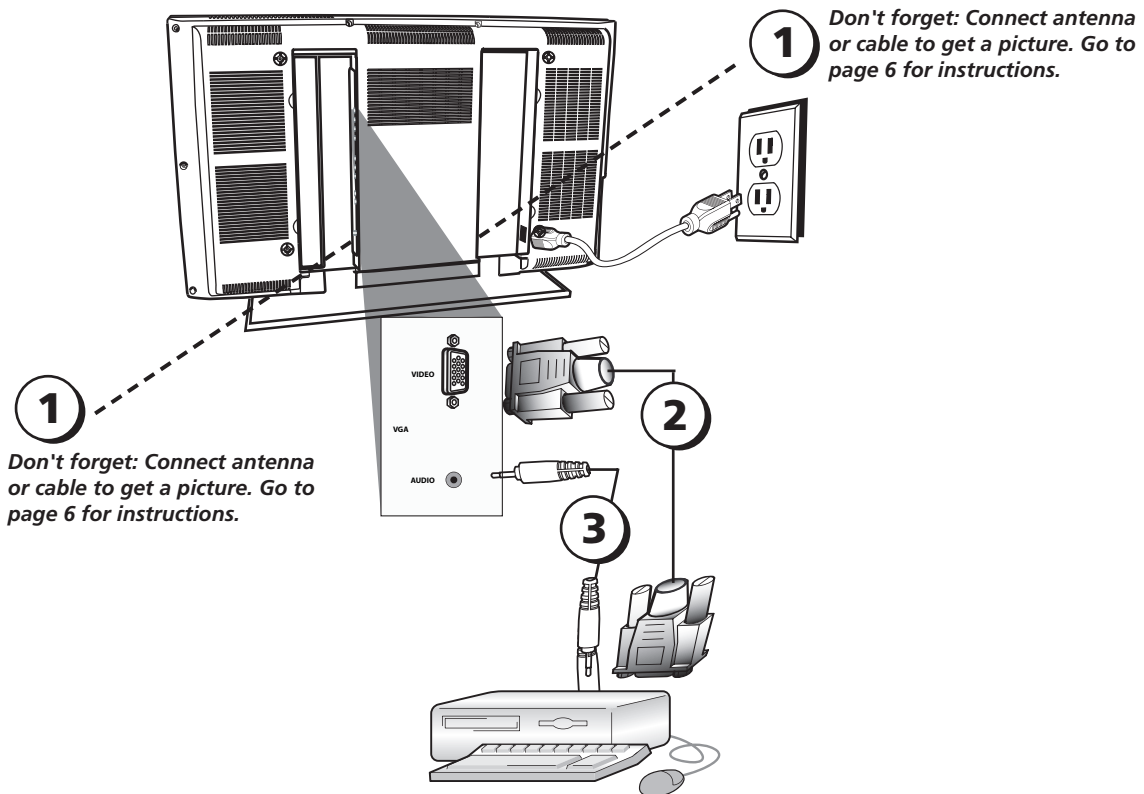

## Connecting the Device

This connection allows you to connect to a personal computer.

- 1. If necessary, connect your cable and/or off-air antenna as described on page 6.**
- 2. Connect your monitor cable.**

Connect one end of a 15-pin monitor cable to the VGA VIDEO jack on the TV and the other end to the PC's video output jack. Note, if your PC's video output isn't 15-pin, you'll need an adapter that can connect to a 15-pin monitor cable.

- 3. Connect your audio cable.**

Connect a 3.5 mm stereo mini pin cable (sometimes referred to as 1/8" stereo mini pin) to the VGA AUDIO jack on the back of the TV and the other end to the Audio Output jack on the PC.

**Notes:** The maximum panel resolution is 1366 x 768. Be sure to set your PC to the correct monitor output setting.

The MultiTask Audio™ feature allows you to listen to the sound from the TV while the PC is connected. Go to page 25 for more information.

## Viewing the PC

1. Plug in the TV (see page 13 for details) and the PC, if they aren't already plugged in.
2. Turn on the TV and the PC.
3. Press the INPUT button on the remote control to scroll through the Video Input Channels until you see VGA displayed at the bottom of the TV's screen. To go back to viewing TV channels, press the ANTENNA button.

## Plug in the TV

Plug the end of the power cord into the back of the TV. Plug the other end into a grounded wall outlet. Insert the plug completely into the outlet. Do not plug into an outlet controlled by a light switch.

## Put Batteries in the Remote

- Remove the battery compartment cover from the back of the remote by pushing the tab and lifting off the cover.
- Insert two fresh batteries. Make sure the polarities (+ and -) are aligned correctly.
- Replace the cover.

## Turn on the TV

Turn on your TV by pressing the Power button on the front of the TV or ON•OFF on the remote control.

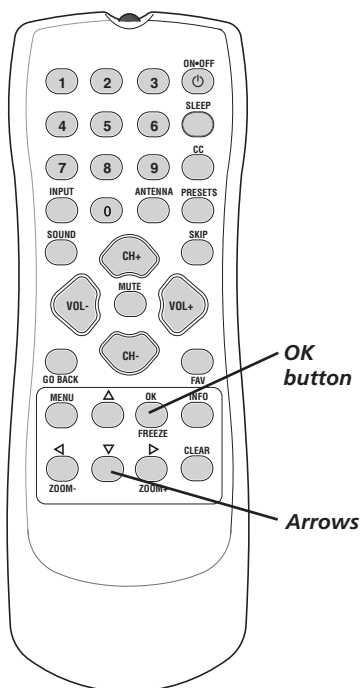

## How to Use the Remote Control to Complete the Initial Setup

The technical term is “Navigation” – how you move through the on-screen menus. The theory is the same throughout the menu screens: highlight your choice and select it.

To highlight a menu item, press the arrow buttons on the remote to highlight one of the items listed on the screen. Use the up or down arrow button to move up or down. Use the right or left arrow button to view other selections for menu choice or display a sub-menu. More than one selection displays, for example, *On...*; a menu choice with a sub-menu displays dots (...).

**Note:** *Highlighted means that the menu item stands out from other menu items on the list (appears darker, brighter, or a different color).*

---

### Tip

To access the setup menus manually, press MENU and choose Setup.

---

## Complete the Initial Setup

The menu system in your TV allows the TV's features to work properly. The first time you turn on your TV, the language screen appears.

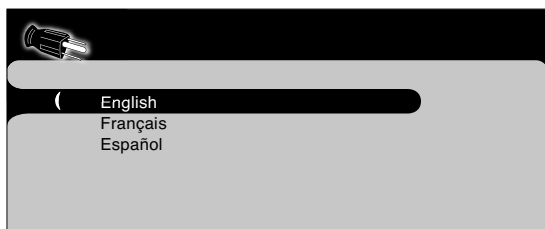

### Set the Menu Language

The first part of the setup allows you to select your preferred language for the menu system.

If English is your preferred language, press OK. To choose another language, press the down arrow button until that language is highlighted, and press OK.

## Complete Channel Setup

Make sure you've connected the TV to cable and/or an off-air signal before you start the next part of the setup.

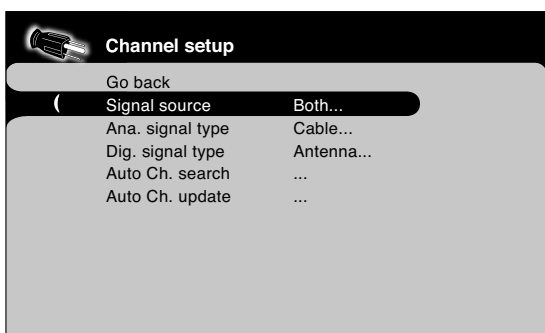

1. A. Did you connect a signal to both ANTENNA/CABLE ANALOG and DIGITAL INPUTS on the back of your TV? If not, go to step 1B. If so, press the down arrow button to highlight *Ana. signal type* and go to step 2.

B. Did you connect a signal to only the ANTENNA/CABLE ANALOG INPUT? If not, go to step 1C. If so press the right arrow button to select *Analog* and then press the down arrow button to highlight *Ana. signal type*. Go to step 2.

C. Did you connect a signal to only the ANTENNA/CABLE DIGITAL INPUT? If not, go to step 4 on the next page. If so, press the right arrow button to select *Digital* and then press the down arrow button to highlight *Dig. signal type*. Go to step 3.

2. A. Did you connect cable to the ANTENNA/CABLE ANALOG INPUT? If not, go to step 2B. If so, leave the option set to *Cable* and then press the down arrow button to highlight *Dig. signal type*. Go to step 3.

B. Did you connect an antenna to the ANTENNA/CABLE ANALOG INPUT? If not, go to step 3. If so, press the right arrow button to highlight *Antenna* and then press the down arrow button to highlight *Auto Ch. search*. Go to step 4.

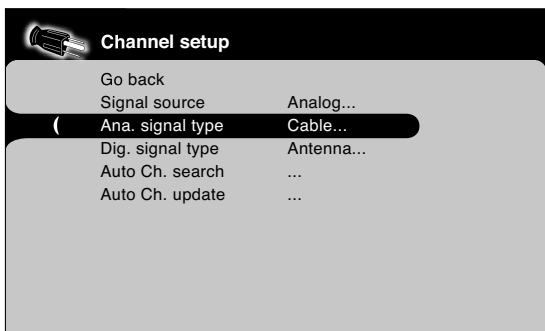

3. If you connected a signal to the ANTENNA/CABLE DIGITAL INPUT, leave the option set to *Autodetection*. The signal type is chosen for you and changes on-screen according to that type when you press the down arrow button. Press the down arrow button to highlight *Auto Ch. search*.

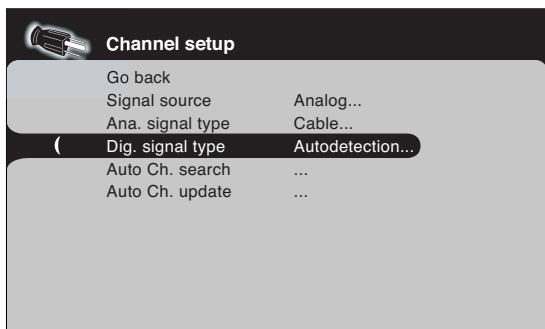

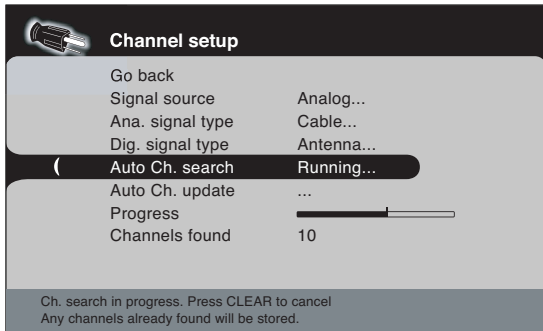

If you connected both cables to the ANALOG and DIGITAL INPUTS, the TV runs 2 separate channel searches.

4. Even though the initial channel search can take several minutes, you must complete it in order for your TV to display channels and programming. Press OK to begin the channel search. The menu shows the TV is running a channel search. When it's complete, the *Channel setup* menu remains on-screen. To exit the menu system, press CLEAR.

Some channels might have been found during the channel search that are unavailable to view and you might want to get rid of these so they don't appear as you change channels. To do this press OK (the *List and Labels* menu appears). Note that removing channels from your channel list may be time consuming, so you might want to do it later. Go to page 30 for details on editing your channel list.

## What To Expect

### Watching TV

- **Remember:** If you have an analog signal connected to your ANTENNA/CABLE ANALOG INPUT, then view analog channels on your Analog Input. Look for an *A* at the bottom of the screen. Press the ANTENNA button if the *A* isn't appearing.

Analog channels are sent in a 4:3 format, which cannot fill a 16:9 screen like your TV so you'll see black bars on each side of the TV program. Press the ZOOM buttons to choose a format that may eliminate the black bars.

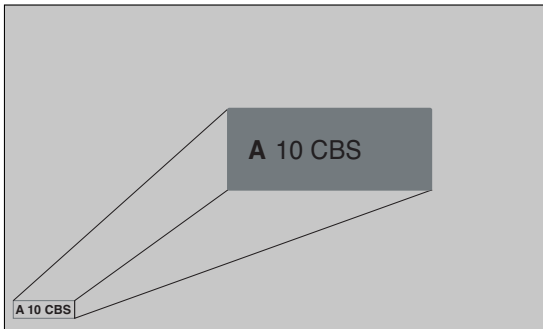

Look for the *A* to make sure you're on the Analog Input.

- **Remember:** If you have a digital signal connected to your ANTENNA/CABLE DIGITAL INPUT, then view digital channels on your Digital Input. Look for a *D* at the bottom of the screen. Press the ANTENNA button if the *D* isn't appearing.

Most digital channels are sent in a 16:9 format which do fill your screen, but not always. It depends on how the station is formatting the video. If the TV program has black bars on each side, unfortunately you can't get rid of them.

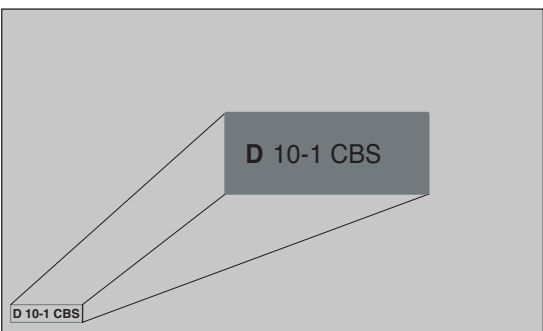

Look for the *D* to make sure you're on the Digital Input.

### Changing Channels

- Digital channels can have both primary channels (like the analog channel number) and sub-channels. First tune to the Digital Input by pressing the ANTENNA button and look for a *D* at the bottom of the screen. To tune to a digital channel with a sub-channel, enter the primary channel number, then press the right arrow button. Enter the sub-channel number and press OK.
- Depending upon the type of signals you have connected to your HDTV, you might notice that the channels change slower than you're used to. This is perfectly normal. Digital cable channels sometimes take longer to tune.

## Explanation of Jacks (in alphabetical order)

This section describes the jacks on the back panel of your TV. There are several ways to connect devices.

**ANTENNA/CABLE ANALOG INPUT** Lets you connect a coaxial cable to receive the signal from the antenna, cable, or cable box.

**ANTENNA/CABLE DIGITAL INPUT** Lets you connect a coaxial cable to receive the signal from the antenna, digital cable, or digital cable box.

**COMPONENT INPUTS** Lets you connect a device that has component video jacks, such as a DVD player.

- **CMP1 Y Pb/Cb Pr/Cr (Component Video)** Provides optimum picture quality because the video is separated into three signals. Use three video-grade component cables for the connection. When using CMP1 Y Pb/Cb Pr/Cr, make sure you connect left and right audio cables to the CMP1 L and R AUDIO jacks.
- **CMP1 L AUDIO** Provides left audio connection when using the CMP1 video inputs. The left audio connector is usually white.
- **CMP1 R AUDIO** Provides right audio connection when using the CMP1 video inputs. The right audio connector is usually red.
- **CMP2 Y Pb/Cb Pr/Cr (Component Video)** Same as described for CMP1 Y Pb/Cb Pr/Cr and CMP1 Audio above. Make sure you connect the left and right audio cables to the CMP2 L and R AUDIO jacks.

**HDMI/DVI Input** Lets you connect a device, such as a digital cable box, with an HDMI or a DVI output.

- **HDMI/DVI INPUT** (High-Definition Multimedia Interface/Digital Visual Interface) Provides an uncompressed digital connection that carries both video and audio data by way of an integrated mini-plug cable. Since HDMI technology is based on Digital Visual Interface (DVI), the jack on the back of your TV is also compatible with DVI devices.
- **L AUDIO (used for DVI only)** Provides left audio connection when using the DVI jack. The left audio connector is usually white.
- **R AUDIO (used for DVI only)** Provides right audio connection when using the DVI jack. The right audio connector is usually red.

*Note: Remember to connect the left and right audio cables because the DVI cable carries only the picture signal, not the sound.*

**MONITOR OUT** Connect a VCR or DVD-recorder to record digital and analog programs from the Cable or Antenna Input (excluding copy-protected programs and component video formats) while the TV is turned on. You must leave the TV on the same channel you are recording.

- **L (Audio)** Provides left audio connection when using the MONITOR OUTPUT jack. The left audio connector is usually white.
- **R (Audio)** Provides right audio connection when using the MONITOR OUTPUT jack. The right audio connector is usually red.

**VGA** Connect your computer, or other device with a VGA output, to this jack using a 15 pin D-sub cable.

**VGA AUDIO (Stereo mini jack)** Use to obtain sound when a PC is connected to the VGA jack. Use a 3.5 mm stereo mini pin cable (sometimes referred to as 1/8" stereo mini pin) to connect a PC to your TV. Go to page 12 for more information.



## Buttons and Other Jacks On Your TV

### Front Panel Buttons

If you cannot locate your remote, you can use the front panel buttons of your TV to operate many of the TV's features.

**MENU** Brings up the TV Main menu.

**VOL >** Increases the volume. In the TV menu system, acts like the right arrow button on the remote control and adjusts menu controls.

**VOL <** Decreases the volume. In the TV menu system, acts like the left arrow button on the remote control and adjusts menu controls.

**CH ^** Scans up through the channel list. In the TV menu system, acts like the up arrow button on the remote control and adjusts menu controls.

**CH v** Scans down through the channel list. In the TV menu system, acts like the down arrow button on the remote control and adjusts menu controls.

**POWER** Turns the TV on and off.

### Right Side Input Jacks (when facing back of TV)

**L/MONO and R AUDIO** Receives audio from another device such as a camcorder, video game console, VCR, or DVD player. Use when connecting to the VIDEO or S-VIDEO Input.

**VIDEO Input** Receives video from another device such as a camcorder, video game console, VCR, or DVD player. To access a device connected to the VIDEO jacks press the INPUT button on your remote until *VID* appears at the bottom of the screen.

**S-VIDEO Input** Allows you to connect an S-Video cable from another device. Make sure you also connect audio cables from the device to the TV. To access a device connected to the VIDEO jacks press the INPUT button on your remote until *SVID* appears at the bottom of the screen.

**Note:** Do not connect an S-Video and a regular video cable to the front jacks at the same time.

 **(Headphones)** Allows you to connect headphones to listen to the sound coming from the TV. To adjust volume control of the headphones, go to the *Headphone settings* option in the *Sound* menu.

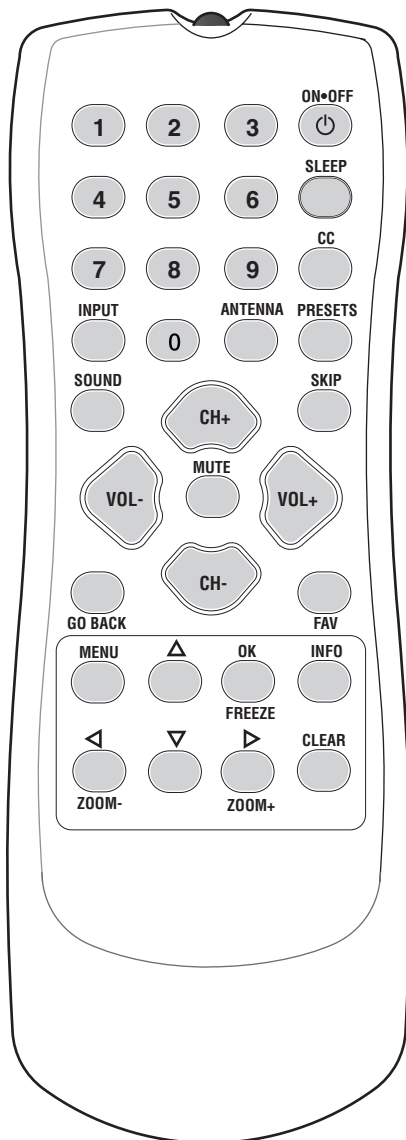

Remote control part number  
R130A1

**Note:** If you need to replace your remote, call 1-800-338-0376. A shipping and handling fee, and the appropriate sales tax, will be charged upon ordering. Have your Visa, MasterCard, or Discover Card ready.

## The Buttons on the Remote Control

**Arrows** Used to highlight different items in the TV menu and to adjust the menu controls.

**(0-9) Number Buttons** Enter channel numbers and time settings directly through the remote control.

To enter a one-digit channel, enter a zero first. To enter a two-digit channel, press the two digits. To enter a three-digit channel, press and hold the “1” button until “1” and two dashes (– –) appear, then add the second two digits. Example: to tune to channel 123, press and hold 1 until “1– –” appears, release the 1 button and then press 2 and 3.

To enter a digital channel with a sub-channel, enter the main channel, then press the right arrow to enter the sub-channel and press OK.

**ANTENNA** Switches between Analog and Digital input channel.

When tuned to an input, press to go back to the most recently used tuner (Antenna or Digital input).

**CC** For the Analog input, displays the *CC setting* and *Analog CC type*; for the Digital input, displays the *CC setting*, *Digital CC type*, and *Digital CC preset*.

**CH + or CH -** Scan up or down through the current channel list. Press once to change the channel up or down; press and hold to continue changing channels.

**CLEAR** Removes any menu or display from the screen and returns you to normal viewing.

**FAV (Favorite- only available for Analog input)** Press to browse the channels set in your *Favorite List*. Go to page 31 for more information.

**FREEZE** While watching TV, freezes the picture. Press OK again to unfreeze.

**GO BACK** Returns you to the previous channel.

**INFO** Brings up the channel banner; press again to clear the screen.

**INPUT** Accesses the available video input channels (*VID*, *SVID*, *CMP1*, *CMP2*, *VGA*, and *HDMI*). Press the CH+ or CH- or ANTENNA button to resume TV viewing.

**MENU** Displays the menu system. If in a sub-menu, takes you back to the previous menu.

**MUTE** Reduces the TV’s volume to its minimum level. Press again to restore the volume.

**OK** When in the menu system, displays sub-menus.

**ON•OFF** Turns the TV on and off.

**PRESETS** For the Analog input, displays *Picture* and *Sound preset* option. For the Digital input, displays *Picture* and *Sound preset*; and *Dig. Ch. Aud. Lang.* and *CH+/CH-* buttons.

**SKIP** Press once before changing channels and the TV will wait 30 seconds before returning you to the original channel. Press repeatedly to add more time. Press CLEAR to cancel SKIP.

**SLEEP** Sets the TV to turn off. Each time you press the right arrow button the clock adds 5 minutes (up to 120 minutes).

**SOUND** For the Analog input, displays the *Tone control* menu. For the Digital input, displays *Picture* and *Sound preset*; and *Dig. Ch. Aud. Lang.* and *CH+/CH-* buttons. In VGA mode, switches to the TV’s audio.

**VOL - or VOL +** Decreases or increases the TV’s volume.

**ZOOM - or ZOOM +** Press left or right to change the size of the picture on-screen.

## Channel Banner

There are several indicators that might appear when you press the INFO button on the remote. This display is called the Channel Banner. The following list describes the items on the Channel Banner screen (left to right and top to bottom).

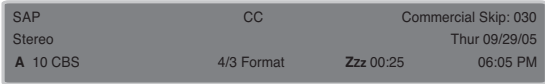

Analog Channel Banner

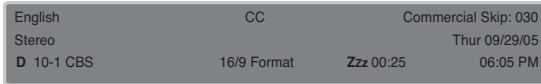

Digital Channel Banner

- SAP** The current channel is broadcasting SAP (Second Audio Program) information.
- CC** Closed Captioning is available on the current channel.
- Commercial skip 0:30** Shows the time remaining on the commercial skip (SKIP) timer.
- Stereo** *Stereo* appears when the current channel is broadcasting in stereo. *Mono* appears when the current channel is broadcasting in mono.
- Thur 09/29/05** Current date.
- A 10 CBS (analog)** The *A* means it's an analog channel. The channel and program you're currently viewing are displayed.
- D 10-1 CBS (digital)** The *D* means it's a digital channel. The channel, sub-channel (if available), and program you're currently viewing are displayed.
- 4/3 or 16/9 format** Current screen format.
- Zzz 00:25** Current time left on sleep timer, if the sleep timer is set.
- 06:05 pm** Current time.

# Using the TV's Features

## Parental Controls and V-Chip

The choices in the *US V-Chip* and *Canada V-Chip* menus involve software inside your TV (referred to as V-Chip) which allows you to block TV programs and movies based on violence, sex, or other content you may believe children should not view.

Once you block programs, you can unblock programs by entering a password.

By default, the software inside your TV is turned off or unlocked. For instructions to lock V-Chip, see below.

**Note:** *Parental control settings are not available for HDMI or CMP1 or 2 inputs.*

## How V-Chip Works for USA and Canada

V-Chip reads the program's age-based rating (TV-MA, TV-14, etc.) and content themes [(Violence (V), Adult Language (L), etc.)]. If you have blocked the rating and/or content themes that the program contains, you will receive the message *This channel is blocked. Change channel or press OK to enter your password and temporarily deactivate the parental controls.*

Broadcasters are not required to provide content themes, so programs received with no content themes will only be blocked if you block their age-based rating. You can also block out programs that have been given an Exempt rating, and programs that are considered unrated. Go to page 38 for the US and Canada ratings explanations.

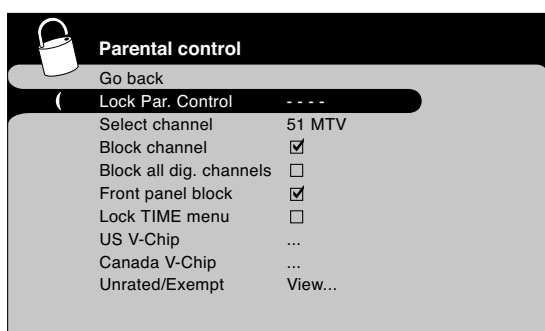

## Lock/Unlock Parental Controls

Selecting this option lets you lock and unlock parental controls settings using a password.

If you do not lock parental controls, none of the settings for V-Chip, Channel Block, or Front Panel Block will take effect.

If you forget your password, turn off the TV. Simultaneously press and hold VOL- on the front panel and CLEAR on the remote for 10 seconds. Next time you enter the *Parental control* menu enter a new password.

## The V-Chip Rating Screen

The following is an example of where items are located within the Rating Limit screen.

### Rating Status Field

Lets you select whether the status of the age-based rating limit to the left is View or Block.

### Rating Field

Lets you select from a list of age-based ratings you can block or view.

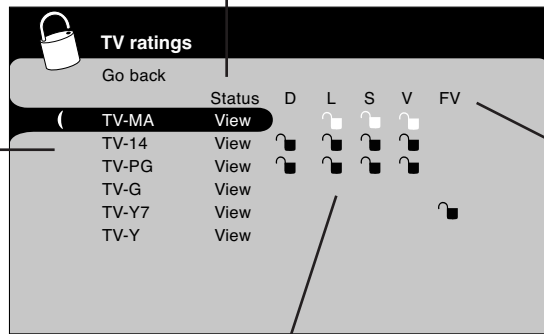

### Content Themes

Lets the content themes you can block or view.

### Content Status Fields

Lets you select which content themes to view for the selected rating, and whether the status of the content theme is currently unlocked (🔓) or locked (🔒).

Hierarchy of Age-Based Ratings	
TV-MA	Mature Audience Only
TV-14	Parents Strongly Cautioned
TV-PG	Parental Guidance Suggested
TV-G	General Audience
TV-Y7	Directed to Children 7 years and older
TV-Y	All Children

## US V-Chip TV Ratings

### Blocking Age-Based Ratings

You can automatically block all program ratings above a specified age-based rating level.

1. Choose *Parental control* from the Main Menu. If Parental controls have previously been locked, you must enter your password.
2. Highlight and select *US V-Chip*. Then select *TV ratings*.
3. Press the up or down arrow button to scroll to the rating corresponding with the lowest rating you do not want the child to watch.
4. Press the OK button to toggle between *View* and *Block*. The status for the rating and all higher ratings automatically changes to Block.
5. Use the up/down arrow buttons to highlight *Go back* and press OK.
6. Select *Lock Parental Controls* from the *Parental Control* menu for rating limits to take effect.

**Note:** If you forget your password, turn off the TV. Simultaneously press and hold VOL- on the front panel and CLEAR on the remote for 10 seconds. Next time you enter the Parental control menu enter a new password.

To view age-based ratings after you've locked them, follow the same steps as above to unlock.

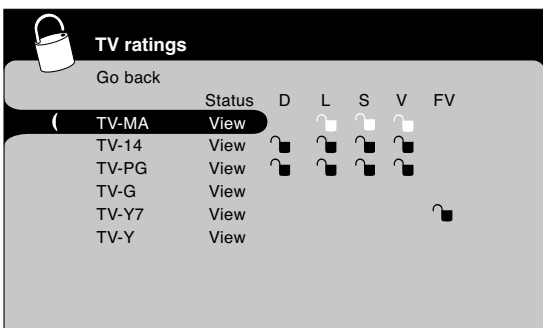

# Using the TV's Features

Content Themes	
D	Sexually explicit dialogue
L	Adult language
S	Sexual situations
V	Violence
FV	Fantasy Violence

## Blocking Specific Content Themes

You can block programs based on their content. (Content is represented by the *D*, *L*, *S*, *V* and *FV* on your screen.) When you block a content theme for a particular rating, you automatically block that content theme for higher rated programs as well.

To block program content:

1. Determine the content themes you want to block.
2. Press the down arrow button to scroll to the rating whose content theme you want to change.
3. Press the right arrow button to move the highlight to a particular content theme.
4. Press the OK button to change its status to lock. (In the example to the left, you block the language (L) corresponding with TV-14. The language for TV-MA is blocked as well.)

**Notes:** Broadcasters are not required to provide content themes or age-based ratings.

You must remember to lock Parental controls for rating limits to take effect.

To view content theme after you've locked them, follow the same steps as above to unlock. Note that if you unlock the language corresponding with TV-14, the language for TV-MA doesn't unlock. You have to unlock the content theme status for each rating separately.

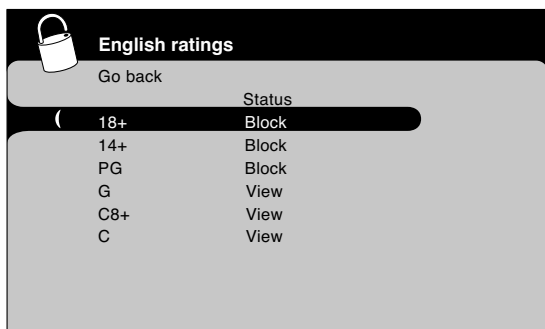
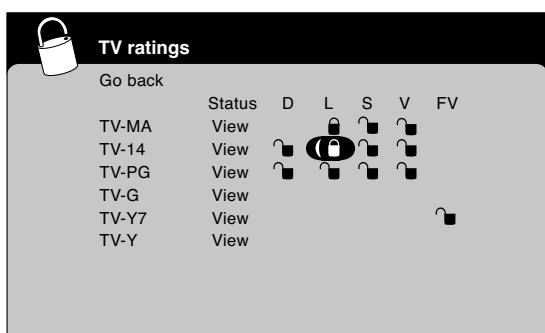

## Blocking Canadian V-Chip Ratings

If you receive Canadian programs you can block Canadian English and French V-Chip by ratings only. When you block a particular rating, you automatically block the higher rated programs as well.

To block Canadian English and French program ratings:

1. Select *Canada V-Chip* from the *Parental control* menu.
2. Highlight *English ratings* or *French ratings* and press OK.
3. Determine the rating you want to block.
4. Press the down arrow button to scroll to the rating you want to change.
5. Press the OK button to change its status to block (all ratings above the one you selected change to block).

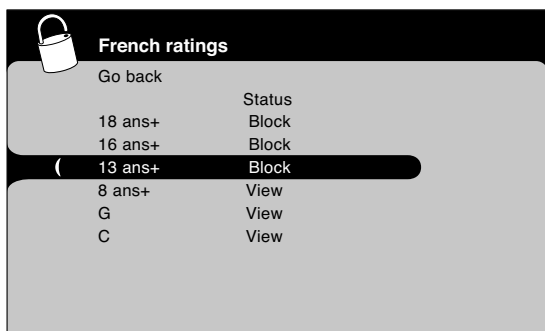

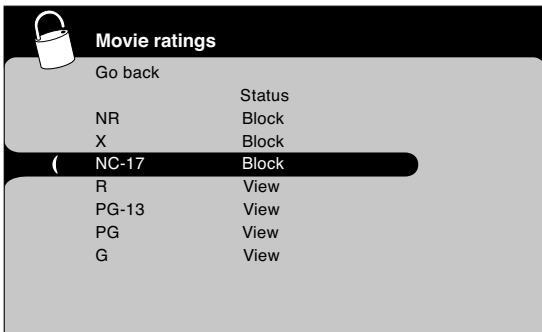

## V-Chip Movie Rating Limit

Set movie rating limits by blocking movies rated above a specified level.

To access the Movie Rating Limit menu:

1. Press MENU on the remote control (the TV's *Main Menu* appears).
2. Select *Parental control*.
3. Select *US V-Chip*.
4. Select *Movie ratings*.

## Blocking Movie Ratings

Once you are in the *Movie ratings* menu, follow the same steps described for blocking Canadian ratings.

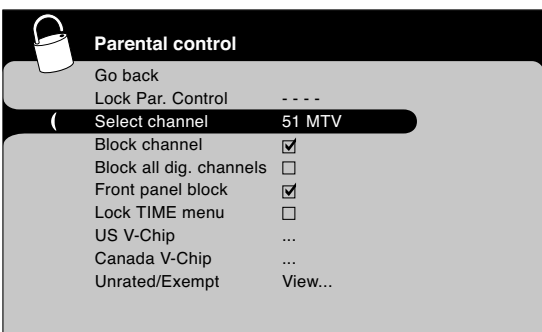

## Block Channels

Turn this option on to block the channel you choose in the *Select channel* option.

Use the number buttons to enter the channel you want to block, then press the down arrow button. Press OK to place a check mark in the *Block channel* box to block the channel. When you tune to that channel you'll need to enter a password to view the channel if the TV is locked.

## Block Digital Channels

Turn this option on to block all digital channels. Press OK to place a check mark in the *Block all dig. channels* box to block all channels. When you tune to a digital channel you'll need to enter a password to view the channel if the TV is locked.

# Using the TV's Features

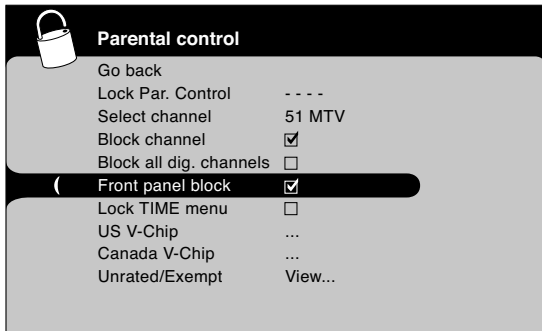

## Front Panel Block

Select this option to block (disable) or unblock (enable) the TV's front panel buttons so that they can't be used by someone, like a young child. The remote still tunes to any channel. If you're using this to keep children from changing channels, remove access to any remote that is capable of operating the television while you have the front panel blocked.

Don't forget to lock parental controls after you change the status. If you don't, the front panel block will not take effect.

## Lock Time Menu

Turn this option on to lock the *Time* menu so that the time settings can't be changed by someone, like a young child. Press OK to place a check mark in the box to lock the Time menu. When you access the *Time* menu you'll need to enter a password to view the channel.

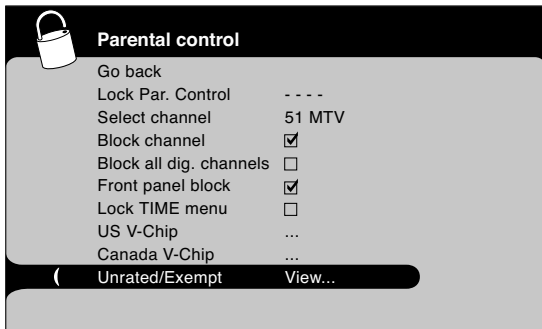

## Blocking Unrated/Exempt Programs

The *Unrated/Exempt* option lets you decide if programs that the V-Chip recognizes as unrated or exempt can be viewed. Unrated TV programs may include news, sports, political, religious, local and weather programs, emergency bulletins, public announcements, and programs without ratings. The Exempt option applies to both USA and Canadian unrated programs and Canadian programs rated *E*.

*View* All unrated programs are available.

*Block* All unrated programs are not available.

**Note:** You must remember to lock Parental controls for rating limits to take effect.

Press the down arrow button to highlight *Unrated/Exempt*. Then press the right arrow button to toggle between *View* and *Block*.

## Future Rating Region

You might notice an option in your Parental control menu that wasn't there before. This is because broadcasters have the capability to add a new rating system for TV programs.



## Additional Features

There are additional features available unrelated to Parental Controls. These features can be found in other menus.

### MultiTask Audio

The MultiTask Audio feature allows you to listen to the sound from the TV while the PC is connected and being used on the VGA input. To use the feature:

1. Tune to the program on the TV you want to listen to.
2. Switch to VGA mode, or PC input, by pressing the INPUT button on the remote until you see *VGA* on-screen.
3. Press the SOUND button on the remote. The sound from the TV program can now be listened to while you use the PC. Press SOUND again to turn off the feature.

**Note:** *The MultiTask Audio feature can also be turned on in the Sound menu, called VGA sound source. Go to page 28.*

### Calendar

Use the calendar feature to display the current month and year, just like a calendar. The current month and year is displayed if you've set it correctly in the *Date* option in the *Time* menu.

1. Press the MENU button on the remote. Highlight *Time* and press OK.
2. Highlight *Calendar* and press OK.
3. To display a different month and year, highlight the selection and press the left or right arrow button to make a change.

# Chapter 3: Using the TV's Menu System

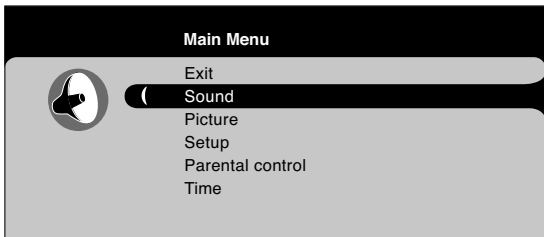

## Using the Menu System

This section explores the menus of your TV. Each menu is outlined and detailed to help you get the most from your TV. The *Parental control* menu is discussed in the Features chapter.

To access the menu system:

1. Press the MENU button.
2. Use the up and down arrow buttons to highlight an option and press OK to display it. The name of the menu is displayed at the top of the menu screen.
3. Press the up and down arrow buttons to move to a different option within the menu. If necessary, press the OK button to display the choices of the option you've highlighted. If available, use the text at the bottom of each screen for help.
4. To return to the Main Menu, press the MENU button until it's displayed.

**Note:** Options in the menus that are grayed-out and can't be highlighted are unavailable.

Descriptions of each menu are discussed in the order they appear.

There are two ways to exit a menu:

- Press the CLEAR button. The menus are cleared from the screen and you return to TV viewing.
- Press the MENU button repeatedly until the menus disappear.

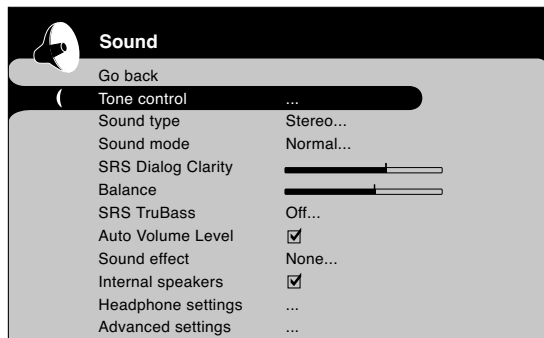

## Sound Menu

The Sound menu lets you adjust audio output. To access the Sound menu, press MENU on the remote, and then select *Sound* from the Main Menu. The following audio items can be adjusted:

**Tone control** If no *Sound effect* is selected, displays *Sound preset* and *Frequency range*. If a *Sound effect* is selected, *Bass* and *Treble* are displayed. Go to the next page for more information on *Sound effect*.

**Sound preset** Allows you to choose a specific sound preset. Press the right arrow to cycle through the options: *Standard*, *Movie*, *Voice*, *Music*, *Flat*, *Videogame*, *Video camera* and *Personal*.

**Frequency range** Displays the different graphic equalizer bands set for each Sound preset option. Choose a band and make adjustments. When you make adjustments, the *Sound preset* option automatically changes to *Personal*. Press the left or right arrow button to select the frequency (120Hz, 200Hz, 500Hz, 1.2kHz, 3kHz, 7.5kHz, 12kHz) you want to adjust. Then use the up or down arrow button to adjust the level. When you're done adjusting the levels, press the MENU button to exit.

To view the frequency range of another *Sound preset* option, press the right or left arrow until no band is selected and *Frequency range* is highlighted. Then press the up arrow to highlight *Sound preset*.

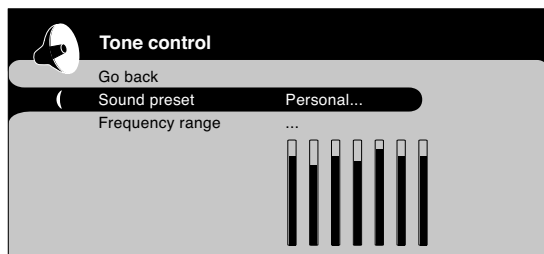

These Tone control settings only appear if no Sound effect is selected.

# Using the TV's Menu System

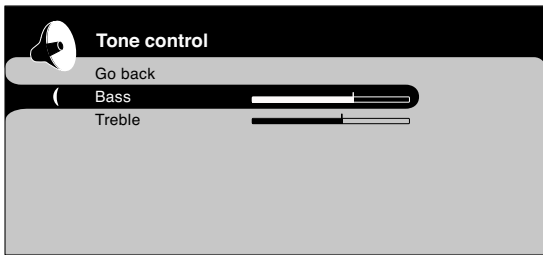

These Tone control settings only appear if a Sound effect is selected.

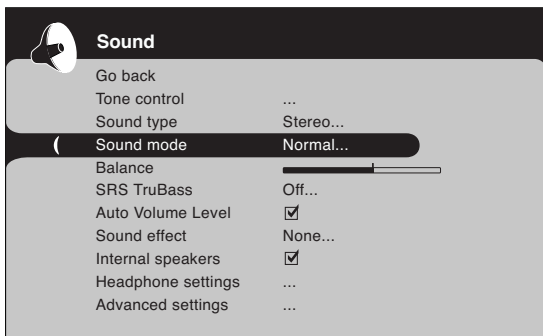

**Bass** Increases or decreases the bass of the sound.

**Treble** Increases or decreases the treble of the sound.

**Sound type** Controls the way the sound comes through your speakers. The options available vary according to the input selected.

**Mono** (available for regular TV viewing only) Plays the sound in mono only. Use this setting when receiving broadcasts with weak stereo signals.

**Stereo** Splits the incoming stereo audio signal into left and right channels. Most TV programs and recorded materials have stereo audio. The word *Stereo* appears in the channel banner when you tune to a program that is broadcast in stereo.

**Sound mode** Provides special processing through your speakers (depending on the setting you chose as your *Sound type*). The available audio modes are:

**Normal** Does not give any special processing, simply provides the mono or stereo sound provided by the signal you're watching.

**Wide** (available only for mono signals) “Widens” sound from mono broadcasts and mono devices connected to your TV for a fuller, more spacious sound.

**Stereo Wide** Available only for stereo signals. Gives a surround effect with more bass.

**SRS WOW** Creates a three-dimensional sound while extending the sound range beyond the size of the speakers.

**Balance** Adjusts how much audio is sent to the left and right speakers.

**SRS TruBass** Allows you to hear deeper, richer low bass tones that normally you wouldn't hear from the speakers.

**Auto Volume Level** Reduces the annoying blasts in volume during commercial breaks, and also amplifies softer sounds in program material. Eliminates the need to constantly adjust the volume.

**Sound effect** These options are best used to provide more depth to the sound: *Opera, Jazz, Rock, Cathedral, Karaoke*. When a sound effect option is selected, *Sound preset* and *Frequency range* aren't available and instead are replaced by *Bass* and *Treble*.

**Internal speakers** Turn on or off the internal speakers. If you have a device connected to the Audio Output jacks on the back of the TV and you want to control the sound by the device instead, uncheck the box.

**Headphone settings** Displays a choice list of available settings you can adjust: *Volume, Bass* and *Treble*. The *Headphone sound* option allows you to choose *Stereo, Mono* or *Auto*. These descriptions are same as for *Sound Type* (see above).

WOW, TruBass, SRS, and (●) symbol are trademarks of SRS Labs, Inc.

WOW and TruBass technologies are incorporated under license from SRS Labs, Inc.

# Using the TV's Menu System

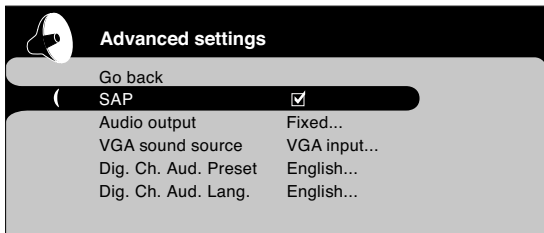

## Advanced settings

**Second Audio Program (SAP)** Plays the program's audio in a second language, if one is available. The letters *SAP* appear in the channel banner when you tune to a program that is broadcast with SAP information. SAP audio is broadcast in mono. SAP is also used to broadcast a program's audio with descriptions of the video for the visually impaired.

**Audio Output** Lets you choose a setting for the AUDIO OUTPUT jacks.

- **Variable** Provides variable output from the MONITOR AUDIO OUTPUT jacks. Use this setting if the TV is not connected to an audio receiver or amplifier and the volume is controlled by the TV.
- **Fixed** Provides fixed output from the MONITOR AUDIO OUTPUT jacks to a receiver or amplifier. With the Fixed Output, the TV's volume control, graphic equalizer, and mute are disabled. This output is ideal when connecting to an audio receiver or amplifier that has its own remote control for controlling the volume.

**VGA sound source** Allows you to listen to the TV's audio while in PC mode. Also known as MultiTask Audio. Go to page 25 for more information.

**Dig. Ch. Aud. Preset** Choose the language you prefer for dialog on digital channels. If your preferred language is being broadcast with a program, then the TV plays it. If not, then the TV plays the default audio for the program (usually English in the U.S.). The default digital channel audio language options are *English, Spanish, French, German, Italian, Japanese, Chinese, and Korean.*

**Dig. Ch. Aud. Lang.** Press the right arrow to choose from the audio languages available for the program you're watching. The language you choose becomes your preferred audio language for all channels on the digital tuner until you turn the TV off. If the language you choose here is not being broadcast with a program, then the TV plays the default audio for the program (usually English in the U.S.).

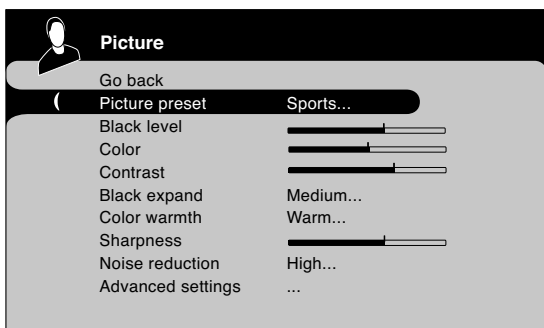

## Picture Menu

The *Picture* menu contains menus and controls to configure how the picture looks. The Picture menu options apply to the video for the main TV and video input selections. All picture options can be applied to each input- VID or SVID, CMP1 or CMP2, VGA, HDMI, Analog and Digital. The VGA and HDMI inputs have different Picture menu options.

**Picture presets (not available on VGA and HDMI)** Displays a choice list that lets you select one of the preset picture settings: *Vibrant, Cinematic, Natural, Sports, Videogame, Video camera or Personal.* Choose the setting that is best for your viewing environment.

**Black Level** Adjusts the brightness of the picture.

**Color** Adjusts the richness of the color.

# Using the TV's Menu System

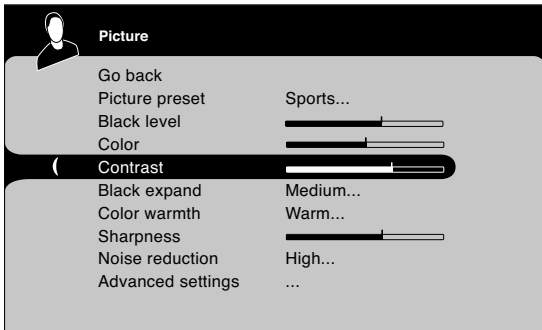

**Contrast** Adjusts the difference between the light and dark areas of the picture.

**Black expand (not available on VGA and HDMI)** Makes the picture appear brighter by deepening the black parts of the picture: *Low*, *Medium* or *High*.

**Color Warmth** Displays a choice list that lets you set one of three automatic color adjustments: *Cool* for a more blue palette of picture colors; *Normal*; or *Warm* for a more red palette of picture colors. The warm setting corresponds to the NTSC standard of 6500 K.

**Sharpness (not available on VGA and HDMI)** Adjusts the crispness of the edges in the picture.

**Noise reduction (not available on VGA and HDMI)** Reduces picture “static” or any type of interference. This feature is especially useful for providing a clearer picture in weak analog signal conditions. Press the right arrow to choose between: *Off* for no noise reduction; *Low* for a softer, smoother picture that retains picture sharpness and detail; *Medium* for a slightly softer picture than the *Low* setting; *High* for an even softer, smoother picture than the other settings (the picture detail is somewhat decreased).

When you change any of these picture settings, the *Picture Preset* changes to *Personal*. Use the left or right arrow button to make adjustments. To return to the *Picture* menu, press the up or down arrow button.

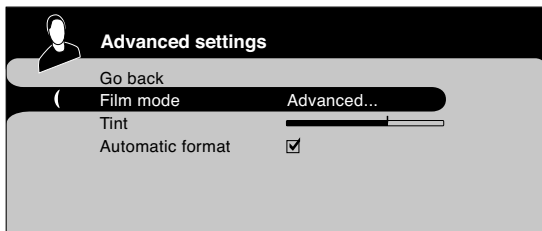

**Advanced picture settings (not available on VGA and HDMI)**

**Film mode (3:2 Pulldown)** Automatically detects video sources that were originally recorded on film (like most movies) and subsequently converted to a different format (for TV broadcast, for example). Film mode processes the converted signal so that it looks as close as possible to the original. Another name for this process is reverse 3:2 pulldown.

**Advanced** (recommended) enables the feature only when the TV detects that movie playback quality could be improved. *Advanced* is the default setting.

The **On** setting should only be used in rare circumstances when the TV is used solely with film-based sources (like DVDs on a non-progressive-scan player).

The **Off** setting turns off film mode upconversion. Try using this setting if you think the reverse 3:2 pulldown is causing distortions in your picture.

**Tint** Adjusts the balance between red and green levels.

**Automatic format** When enabled (box checked) the TV automatically detects the screen format the signal is sending for each channel, as well as input channels.

**Note:** *Automatic format and Video noise reduction are available for the CMP1 input only if the signal is 480i.*

---

## Tip:

If the picture is switching screen formats abruptly during normal TV viewing, switch the Automatic format feature off.

---

# Using the TV's Menu System

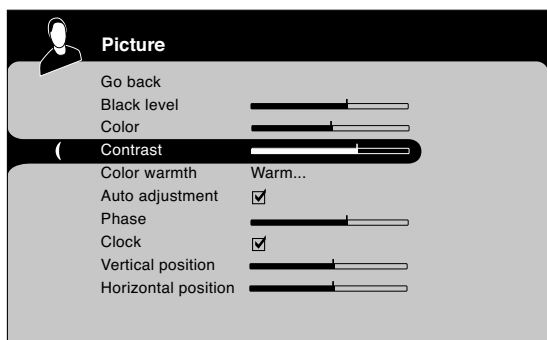

VGA and HDMI Picture menu

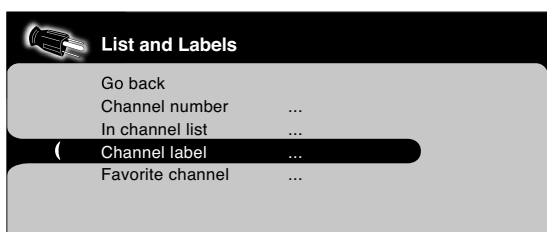
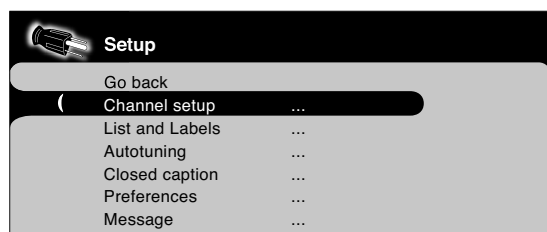

The following Picture menu options are only available for VGA and HDMI inputs.

**Auto adjustment** Adjusts the position of the picture automatically.

**Phase** Adjusts the picture if there is flicker of screen letters, color misalignment, or blurring.

**Clock** Adjusts the clock sync of the picture.

**Vertical position** Adjusts the picture's position upward or downward.

**Horizontal position** Adjusts the picture's position left or right.

## Setup Menu

The Setup menu lets you configure the TV to fit its surroundings and your preferences. To access the *Setup* menu, press MENU on the remote, and then select *Setup* from the Main Menu.

### Channel setup

**Signal source** If you connected a signal to the ANTENNA/CABLE ANALOG INPUT only, select *Analog*. If you connected a signal to the ANTENNA/CABLE DIGITAL INPUT only, select *Digital*. If you connected a signal to both inputs, select *Both*.

**Analog signal type** (available for the analog tuner only) The analog signal type was set during the initial setup. If you change how you receive broadcasts through the ANTENNA/CABLE ANALOG INPUT, you must change the *Signal type* setting. Choose *Cable* if you are using cable or a cable box for TV signals. Choose *Antenna* if you are using an off-air antenna for analog TV signals.

**Dig. signal type** (available for the digital tuner only) The digital signal type was set during the initial setup. If you change how you receive broadcasts through the ANTENNA/CABLE DIGITAL INPUT, you must change the *Signal type* setting. Choose *Cable* if you are using cable or a cable box for TV signals. Choose *Antenna* if you are using an off-air antenna for digital TV signals.

**Auto Ch. search** Searches for channels the signal is receiving. Go to page 14 for more information.

**Auto Ch. update** Searches for any new channels that are not in your channel list and adds them to the list.

**List and Labels** Edit the channels in the list or choose labels for each channel.

**Channel number** Use the number buttons on your remote to enter the channel number.

**In channel list** If you've entered a channel you want to add to the channel list, highlight *In channel list* and press the right arrow to place a check in the check box. If you've entered a channel you want to delete from the channel list, press the right arrow button to uncheck the box.

**List and Labels continued on next page...**

# Using the TV's Menu System

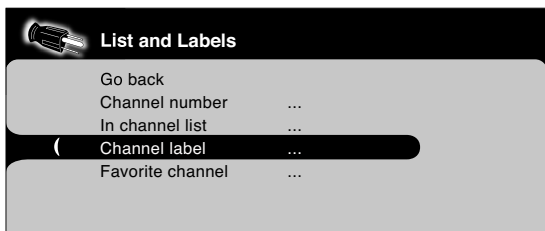

**Channel label** Allows you to add a six character label, which is displayed on-screen when you tune to the channel entered in the *Channel number* option above. Press the up and down arrow button to scroll through the available characters. Continue to press the right arrow button to highlight the next space to add another character. Press the left arrow button to erase the label.

**Favorite channel (available only for Analog channels)** The channel you entered for *Channel number* can be saved as a favorite channel. You can have up to 6 favorite channels for your analog channels and 6 for your digital channels. Then use your FAV button on the remote to scroll through your favorite channels.

**Autotuning** Not available with your remote. Go to Chapter 4 for details about the Autotuning feature if you have a compatible RCA universal remote.

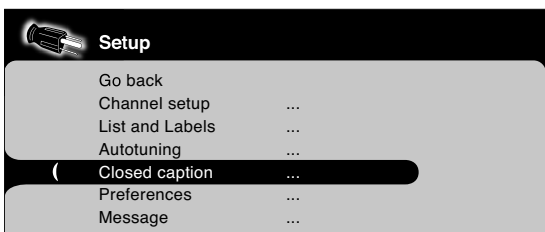

**Closed caption** Many programs are encoded with closed-captioning information, which lets you display the audio portion of a program as text on the TV screen.

Closed captioning is not available on all channels at all times. Only specific programs encoded with closed-captioning information. When a program is closed captioned, *CC* is displayed in the channel banner. See Chapter 2 for more information about the channel banner. The closed caption options are:

**CC setting** Lets you choose the way closed captioning information appears on the screen.

**Off** No captioning information displayed.

**On always** Captioning information shown always, when available.

**On when mute** Displays captioning information, when available, whenever the TV's sound is muted by pressing the MUTE button. The captioning information is not displayed when the sound is not muted.

**Analog CC type** If available, lets you select the captioning mode used for displaying captioning information. If you are unsure of the differences among the modes, you may prefer to leave the closed captioned mode set to CC1, which displays complete text of the program in the primary language in your area.

**Digital CC type** If available, lets you select a closed caption service mode (1-6) for digital channels.

**Digital CC preset** If available, lets you select between *Default* and *Custom* options. Custom changes according to what you set for the options below.

**Closed caption options continued on next page...**

# Using the TV's Menu System

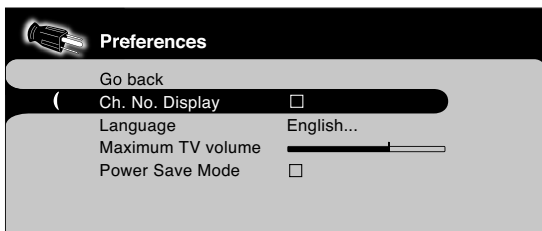
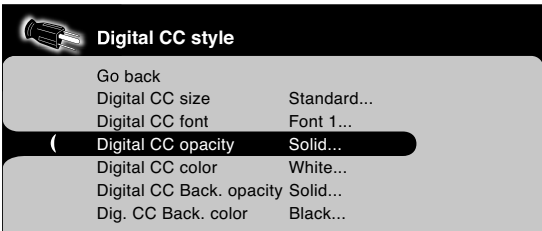
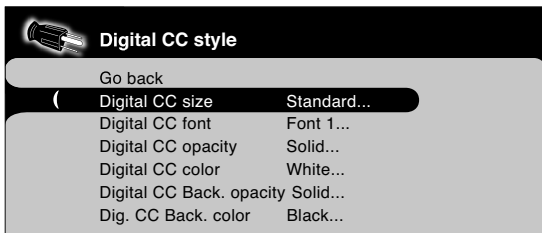

**Digital CC style** If available, lets you customize the following display options:

**Digital CC size** Lets you set the size of the digital closed-caption text. You can choose *Standard*, *Large*, or *Small*.

**Digital CC font** Lets you select a character design for the digital closed-caption text. A font is a complete assortment of letters, numbers, punctuation marks, etc. of a given design. You can choose from a variety of fonts (Ashley, Floridian, etc.).

**Digital CC opacity** Lets you set the appearance of the digital closed-caption text: *Solid*, *Transparent*, *Translucent*, or *Flashing*.

**Digital CC color** Lets you choose the color of the digital closed-caption text: *White*, *Black*, *Red*, *Green*, *Blue*, *Yellow*, *Magenta*, or *Cyan*.

**Digital CC back. opacity** Lets you set the appearance of the space behind the digital closed-caption text: *Solid*, *Transparent*, *Translucent*, or *Flashing*.

**Dig. CC back. color** Lets you choose the color of the area of the screen behind the digital closed-caption text: *White*, *Black*, *Red*, *Green*, *Blue*, *Yellow*, *Magenta*, or *Cyan*.

**Note:** These captioning style options only have an effect on true digital closed captions.

Not all captioning on digital channels is digital captioning—it depends on what the broadcaster is sending. If the closed captioning for a program is not digital, the Digital CC style settings will not have an effect.

## Preferences

**Ch. No. Display** Turn this feature on if you want the channel number displayed on-screen.

**Language** Lets you select your preferred language for the menus: *English*, *Español* or *Français*.

**Maximum TV volume** This feature is intended to stop volume from being turned up too loudly. Set the volume at the loudest level you'd want to hear. Press and hold OK to hear the maximum volume you set.

**Power Save Mode** If no signal is detected from the VGA input jack for 5 minutes, puts the TV in power save mode.

"Monotype" is a trademark of Monotype Imaging, Inc. registered in the U.S. Patent and Trademark Office and may be registered in certain other jurisdictions.

"iType" is a trademark of Monotype Imaging, Inc. and may be registered in certain other jurisdictions.

"Floridian", "Plate Gothic", and "Screen" are trademarks of The Monotype Corporation and may be registered in certain other jurisdictions.

"Ashley" is a trademark of The Monotype Corporation Registered in the U.S. Patent and Trademark Office and may be registered in certain other jurisdictions.



# Using the TV's Menu System

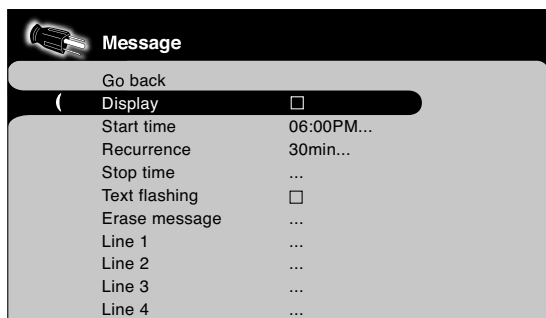

**Message** Set a message that appears at the bottom of the TV screen. Press the CLEAR button to clear the message. If *Display* is turned on, the message appears when the TV is turned back on after being turned off.

**Display** Turns on or off to display a message on the TV.

**Start time** Set the time you want to display the message. Not available if the time hasn't been set in the *Time* menu.

**Recurrence** Set how often to display the message- 10min- 60 min.

**Stop time** Set the time you want to the message to stop.

**Text flashing** Turn on to display the message flashing.

**Erase message** Clears all lines of text you've entered.

**Line 1-Line 4** Enter up to 4 lines of text- 25 characters per line. Press the right arrow button to start entering text on a line, then press the up and down arrow buttons to change characters. Press OK when you're done entering text for a line.

## Parental Control Menu

The Parental control menu was explained in Chapter 2. Go to page 20 for more information.

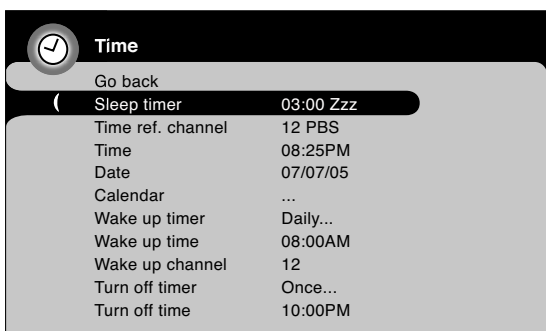

## Time Menu

**Sleep timer** Lets you set the TV to turn off after a given amount of time.

**Time ref. channel** Choose your PBS station to have the TV set the time for you.

**Time** Lets you enter the current time. If it is eight o'clock, for example, you must first enter the number zero, then number eight. Use the OK button to choose between AM and PM.

**Date** Lets you set the current day, month, and year.

**Calendar** Displays the current month and year with the day highlighted according to what you set for the *Date* option above.

**Wake up timer** Lets you set the TV to turn itself on.

*Note: The Wake up timer is available only when the time has been set.*

**Wake up time** Lets you set the time you want the TV to turn itself on.

**Wake up channel** Lets you select a specific channel the TV tunes to when the wake up timer is set. To enter a digital channel, press ANTENNA button on your remote.

**Turn off timer** Lets you set the TV to turn itself off.

**Turn off time** Lets you set the time you want the TV to turn itself off.

## Frequently Asked Questions (FAQs)

### **What's the quickest way to view High Definition (HD) video?**

Connect an off-air antenna to the ANTENNA CABLE/DIGITAL INPUT to view free local digital channels. You might need to purchase an antenna. Go to page 6 for more information.

Visit [www.antennaweb.org](http://www.antennaweb.org) to get help deciding what type of antenna to use to receive the local digital channels available to you. By entering where you live, this mapping program tells you what local analog and digital stations are available using a certain antenna.

### **Why are there black bars on my screen and can I get rid of them?**

Analog channels are sent in a 4:3 format, which cannot fill a 16:9 screen like your TV. Press the ZOOM +/- buttons to choose a format that may eliminate the black bars.

Most digital channels are sent in a 16:9 format which do fill your screen, but sometimes are sent in 4:3. It depends on how the station is formatting the video. Unfortunately, you can't get rid of the black bars.

### **How do I tell an analog channel from a digital channel?**

Press the INFO button to display the channel banner. Look at the left corner for a channel number. Channels with a primary channel and a sub-channel are digital channels, but not all digital channels have sub-channels. Look at the middle for the format (4:3 for analog and sometimes digital; 16:9 for digital) the TV is receiving. Go to page 19 for more information.

### **Why does channel search find a lot of channels, but when I try to tune to them there's nothing there?**

Some channels are enabled by the cable company that don't carry programming, such as video-on-demand. When channels are unavailable, your TV's screen is blank or appears like snow. You probably want to get rid of these so they no longer appear in your channel list. Remove these in the *Channel List* menu. Go to page 30 for more information.

### **Why does the first channel search take a long time?**

If you've connected a signal to both ANALOG and DIGITAL INPUTS, the TV is looking for all available channels in the channel list. If you do have digital channels, the TV is also searching for each sub-channel of that digital channel.

## Troubleshooting

Most problems you encounter with your TV can be corrected by consulting the following troubleshooting list.

*Note for US customers: If you prefer, we can provide you with the name of an Authorized Service Representative who will visit your home for a fee to install your electronic entertainment system and to instruct you in its operation. For details about this service, call 1-888-206-3359. For additional assistance while using your RCA product, please visit [www.rca.com/customersupport](http://www.rca.com/customersupport).*

### TV Problems

---

#### TV won't turn on

- Make sure the TV is plugged in.
- Check the wall receptacle (or extension cord) to make sure it is “live” by plugging in something else.
- The front panel controls may be locked (disabled). Use the remote control to unlock the front panel controls by selecting the *Front Panel Block* in the *Parental control* menu and press OK to uncheck the box.

#### No picture, no sound but TV is on

- You might be tuned to an input with no device connected to it to view. If you're trying to view a connected device, press INPUT until the picture from that device appears or press ANTENNA to watch TV.
- Maybe the *Signal source* option is set incorrectly. Go to page 30 for detailed instructions.
- The channel might be blank — change channels.
- If you're watching your VCR and it's connected with coaxial cable to the ANALOG or DIGITAL INPUT jack, tune the TV to channel 3 or 4 (whichever channel is selected on the 3/4 switch on the back of your VCR). Also check to make sure the TV/VCR button on the VCR is in the correct mode (press the TV/VCR button on your VCR).

#### Sound okay, picture poor

- If you're getting a black and white picture from a device you've connected to your TV, you might have your video cables connected to the wrong jacks. A yellow Video cable connects to the yellow VIDEO input jack on the side of your TV; three yellow video cables or bundled component video cables (red, blue, and green) connect to the COMPONENT INPUT jacks on the back of your TV.
- If you're getting no picture from a device you've connected to your TV, you might have your video cable connected to the MONITOR OUT jacks on the back of your TV. These jacks are used to connect recording devices. A yellow Video cable connects to the yellow VIDEO input jack on the side of your TV.
- Check antenna connections. Make sure all of the cables are firmly connected to the jacks.
- Try adjusting sharpness function to improve weak signals. Go to page 29 for more instructions.

#### No sound, picture okay

- Maybe the sound is muted. Try pressing the volume up button to restore sound.
- If using S-Video or Y, PB, PR, remember to also connect the device's left and right audio output jacks to the TV's L and R Audio Input jacks.
- The sound settings may not be set correctly. Go to page 26 for more information.
- The internal speakers might be turned off. Go to page 27 for more information.

#### Blank screen

- Check your connections. If you used yellow, red, and white cables to connect, make sure they're connected to the yellow, red, and white jacks on the side of the TV, not to the MONITOR OUT jacks on the back of the TV.
- Make sure the device connected to the TV is turned on.
- Try another channel.
- If you're trying to watch something that's playing on a device connected to the TV (like a DVD), press INPUT until you get to the correct video input channel.
- Press the ANTENNA button.

# Other Information

---

## Buttons don't work

- The front panel controls may be locked (disabled). Use the remote control to unlock the front panel controls by selecting the *Front Panel Block* in the *Parental control* menu and press OK to uncheck the box.
- Unplug the TV for ten minutes and then plug it back in. Turn the TV on and try again.

## TV turns off unexpectedly

- Sleep timer may have been activated. Go to page 33 for instructions.
- Electronic protection circuit may have been activated because of a power surge. Wait 30 seconds and then turn on again. If this happens frequently, the voltage in your house may be abnormally high or low.
- Unplug. Wait ten minutes. Plug in again.

## TV turns on unexpectedly

- Wake up timer might have been activated. Go to page 33 for instructions.

## Can't select certain channel

- Channel may be blocked or not approved in the *Parental Controls* menu.
- If using a VCR, check to make sure the TV/VCR button on the VCR is in the correct mode (press the TV/VCR button on your VCR).
- Press the ANTENNA button and then try to change channels.

## Noisy stereo reception

- May be a weak station. Use *Sound* menu to choose mono sound.

## Volume buttons not adjusting volume louder

- Check to make sure volume isn't limited by the maximum volume feature. Go to page 32 for more instructions.

## Black box appears on the screen

- Closed-captioning might be on. Check *Closed Caption* in the *Setup* menu. Go to page 31 for more instructions.

## TV picture keeps switching between screen formats abruptly

- Switch the *Automatic format* feature off. See page 29 for more information.

## ***Problems with HDMI/DVI Connection***

---

- Make sure the HDMI or DVI device is turned on and the cables are firmly connected. If problems still occur, turn off your device. Re-connect your device. Reset the power by unplugging the power cord and plugging it back in.
- If you are tuned to the HDMI/DVI input and you're receiving *Unusable Signal* message on-screen, press the INFO button on the remote. If *Acquiring Channel* appears in the channel banner, the HDMI or DVI device isn't responding. Contact the manufacturer of the HDMI or DVI device for further assistance.
- If you tune to the HDMI/DVI input and you see snow, the video goes in and out, or the video takes a long time to appear, your HDMI or DVI device is having trouble sending video information to the TV. Re-connect your device. Reset the power by unplugging the power cord and plugging it back in. If problems persist, try connecting the Y Pb Pr jacks instead if they are available or contact the manufacturer of the HDMI or DVI device for further assistance.
- If you have black bars on each side of your picture, the device you connected might have a switch or a menu option allowing you to change the picture quality output that will fix this. Choose either 720p or 1080i.
- 480i signals aren't supported by the HDMI/DVI input.

### ***The Remote Control Doesn't Work***

---

- Something might be between the remote and the remote light sensor on the front of the TV. Make sure there is a clear path.
- Maybe the remote isn't aimed directly at the TV.
- Maybe batteries in remote are weak, dead, or installed incorrectly. Put new batteries in the remote. (Note, if you remove the batteries, you may have to reprogram the remote to operate other devices.)

### ***Problems with V-Chip/Parental Controls***

---

#### **The rating limits don't work**

- You must lock the settings. Go to the *Main Menu* (press MENU on your remote), select *Parental control*, select *Lock Parental Controls*.

#### **I don't remember my password and I want to unlock the TV**

- If you forget your password, turn the TV off. Simultaneously press and hold VOL- on the front panel and CLEAR on the remote for 10 seconds. Next time you enter the *Parental control* menu enter a new password

#### **The V-Chip won't let me watch a program even though it's not rated as violent.**

- Maybe the movie was given an NR (Not Rated) status. After you block movie ratings, you must set *NR* to *View* separately in order to view movies with an NR rating.

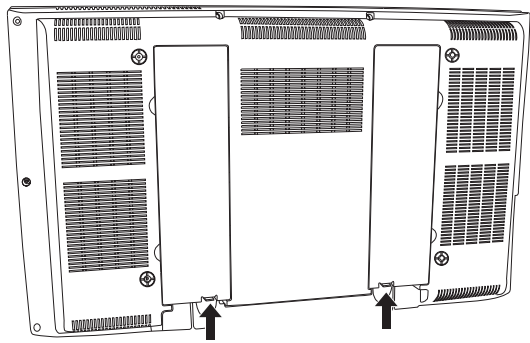

Remove the two jack covers to remove the base.

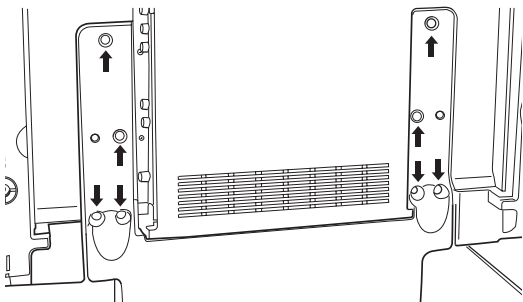

Remove the screws from the four holes on each side of the TV's base.

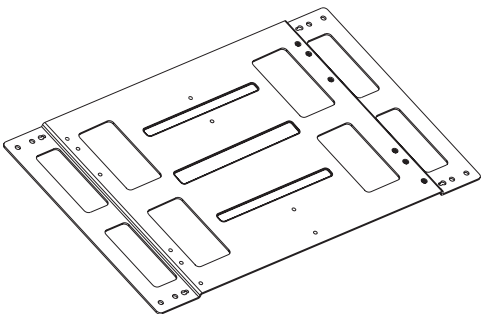

Wall mount plate (L26WD12 only)

Attach plate using these holes.

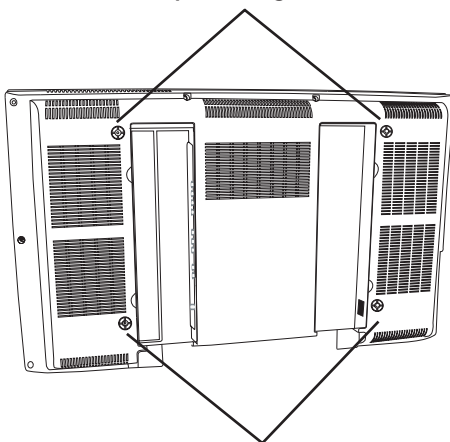

Attach plate using these holes.

## Mounting Your TV to the Wall

**Caution:** The wall mount must bear a minimum of five times the TV's net weight without causing damage.

Model L26WD12 comes packed with a wall mount plate. Models L32WD12 and L37WD12 don't need a wall mount plate to attach the TV to the wall. You simply purchase a VESA wall mount. Follow steps 1 and 2 below, then follow the instructions included with the wall mount.

For model L26WD12, purchase a VESA wall mount that has mounting measurements of 200mm horizontally and 100mm vertically. For models L32WD12 and L37WD12, purchase a VESA wall mount that has mounting measurements of 400mm horizontally and 200mm vertically.

To attach the plate (for model L26WD12 only):

1. You need to remove the base first in order to attach the plate.
  - A. Place the TV facedown on a surface that is soft, yet strong enough to hold the TV.
  - B. Remove the two jack panel covers by pushing up on the tabs and pulling the covers out carefully.
  - C. Use a screwdriver to remove the screws from the four holes on each side of the TV's base as the arrows indicate on the base.
2. Make sure all devices are already connected, then put the covers back into place over the jack panels.
3. Locate the wall mount plate.
4. Attach the plate to the back of the TV with the four screws packed with the wall mount plate.
5. Follow the directions included with the wall mount to mount the TV to the wall.

### V-Chip Rating Explanations

#### US V-Chip Rating System

**TV-MA (Mature Audience Only)** Specifically designed to be viewed by adults and may be unsuitable for children under 17. It contains one or more of the following content themes: crude indecent language (L), explicit sexual activity (S), or graphic violence (V).

**TV-14 (Parents Strongly Cautioned)** Contains some material that many parents would find unsuitable for children under 14. Parents are strongly urged to exercise greater care in monitoring this program and are cautioned against letting children under the age of 14 watch unattended. This program contains one or more of the following content themes: intensely suggestive dialogue (D), strong coarse language (L), intense sexual situations (S), or intense violence (V).

**TV-PG (Parental Guidance Suggested)** Contains material that parents may find unsuitable for younger children. Many parents may want to watch it with their younger children. The program contains one or more of the following content themes: some suggestive dialogue (D), infrequent coarse language (L), some sexual situations (S), or moderate violence (V).

**TV-G (General Audience)** Most parents would find this program suitable for all ages. It contains little or no sexual dialogue (D) or situations (S), no strong language (L), and little or no violence (V).

**TV-Y7 (Directed to Children 7 years and older)** Designed for children ages 7 and above. It may be more appropriate for children who have acquired the developmental skills needed to distinguish between make-believe and reality. Themes and elements in this program may include mild fantasy violence (FV) or comedic violence, or may frighten children under the age of 7.

**TV-Y (All Children)** Themes and elements in this program are designed for a young audience, including children from ages 2-6. It is not expected to frighten younger children.

#### Canadian English V-Chip Rating System

**18+ (Adults)** Programming intended for adults 18 and older. It may contain elements of violence, language, and sexual content which could make it unsuitable for viewers under 18. Violence Guidelines: May contain violence integral to the development of the plot, character or theme, intended for adult audiences. Other Content Guidelines: May contain graphic language and explicit portrayals of nudity and/or sex.

**14+ (Viewers 14 and over)** Programming contains themes or content which may not be suitable for viewers under the age of 14. Parents are strongly cautioned to exercise discretion in permitting viewing by pre-teens and early teens. Violence Guidelines: May contain intense scenes of violence. Could deal with mature themes and societal issues in a realistic fashion. Other Content Guidelines: May contain scenes of nudity and/or sexual activity. There could be frequent use of profanity.

**PG (Parental Guidance)** Programming intended for a general audience but which may not be suitable for younger children (under the age of 8). Parents may consider some content inappropriate for unsupervised viewing by children aged 8-13. Violence Guidelines: Depictions of conflict and/or aggression will be limited and moderate; may include physical, fantasy, or supernatural violence. Other Content Guidelines: May contain infrequent mild profanity, or mildly suggestive language. Could also contain brief scenes of nudity.

**G (General Audience)** Programming considered acceptable for all ages groups. While not designed specifically for children, it is understood younger viewers may be part of the audience. Violence Guidelines: Will contain very little violence, either physical or verbal or emotional. Will be sensitive to themes which could frighten a younger child, will not depict realistic scenes of violence which minimize or gloss over the effects of violent acts. Other Content Guidelines: There may be some inoffensive slang, no profanity and no nudity.

# Other Information

---

**C8+ (Children 8 and Older)** Programming generally considered acceptable for children 8 years and over to watch on their own. Violence Guidelines: Violence will not be portrayed as the preferred, acceptable, or only way to resolve conflict or encourage children to imitate dangerous acts which they may see on television. Any realistic depictions of violence will be infrequent, discreet, of low intensity and will show the consequences of the acts. Other Content Guidelines: There will be no profanity, nudity or sexual content.

**C (Children)** Programming intended for children under age 8. Violence Guidelines: Careful attention is paid to themes which could threaten children's sense of security and well being. There will be no realistic scenes of violence. Depictions of aggressive behaviour will be infrequent and limited to portrayals that are clearly imaginary, comedic or unrealistic in nature. Other Content Guidelines: There will be no offensive language, nudity or sexual content.

## Canadian French V-Chip Rating System

**18+ (Adults)** Programming is for adults only. This program contains sustained violence or extremely violent scenes.

**16+ (Viewers 16 and over)** Programming is not suitable for those under age 16. This program contains frequent scenes of violence or intensely violent scenes.

**13+ (Viewers 13 and over)** Programming may not be suitable for children under the age of 13. This program either contains several violent scenes or one or more scenes that are violent enough to affect them. Viewing in the company of an adult is therefore strongly recommended for children under the age of 13.

**8+ (Viewers 8 and over)** Not recommended for young children. This program is suitable for most audiences, but it contains mild or occasional violence that could upset young children. Viewing in the company of an adult is therefore recommended for young children (under the age of 8) who do not distinguish between reality and imagination.

**G (General Audience)** This program is suitable for audiences of all ages. It contains no violence, or any violence that it does contain is either minimal or is presented in a humorous manner, as a caricature, or in an unrealistic way.



## Autotuning

*Note: Autotuning is not available with your remote. You must purchase a compatible RCA universal remote to use the autotuning feature.*

The autotuning feature automatically tunes the TV to the correct video input channel for different devices you have connected to your TV. When you set up autotuning in the menu system you don't have to remember to change your TV to the VID input, for example, when you want to watch a tape on the VCR.

## How to Set Up the Autotuning Feature

The way you set up the autotuning feature in the TV's menu corresponds to the device buttons on the remote and the way you have each device connected to your TV. When you set up autotuning, you're telling the TV what channel/input to tune to when you press the corresponding button on the remote control.

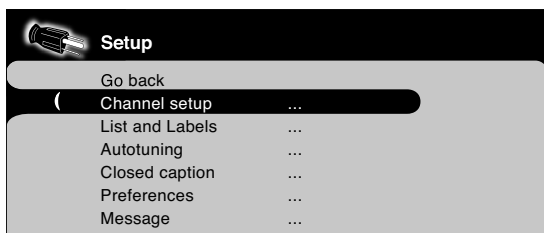

1. Press MENU (the MAIN MENU appears).
2. Highlight *Channel setup* and press OK on your remote control.
3. Highlight *Autotuning* and press OK.
4. Choose which device button you would like to set:

**Set VCR Channel** Lets you set up the channel the TV tunes to when you press the VCR button.

**Set DVD Channel** Lets you set up the channel the TV tunes to when you press the DVD button.

5. Press the right arrow button to select the choice that matches the way you have the device connected to this TV, and press OK.

You can select from the following inputs or channels:

**N/A** Choose this if you don't have this particular device connected to the TV, or if you don't want the TV to automatically tune to the correct channel/input when you're using this device.

**Channel 3 or 4** Device is connected to the ANTENNA/CABLE ANALOG or DIGITAL INPUT jack on the back of the TV, and you want the TV to tune to channel 3 when you press the corresponding button on the remote. Reminder: make sure the device's Channel 3/4 switch is set to channel 3.

**VID or SVID (Video or S-Video Input)** Device is connected to a VIDEO or S-Video jack on the side of the TV and you want the TV to tune to the front VIDEO or S-VIDEO input channel when you press the corresponding device button.

**CMP1 or CMP2 (Component Video Input)** Compatible component video source, such as an HDTV tuner or satellite receiver, is connected to the three COMPONENT VIDEO INPUT jacks (Y Pb Pr) on the back of the TV and you want the TV to tune to the component video input channel (CMP1 or CMP2) when you press the corresponding device button.

**HDMI** Device is connected to the HDMI/DVI jack on the back of the TV and you want the TV to tune to the HDMI input channel when you press the corresponding device button.

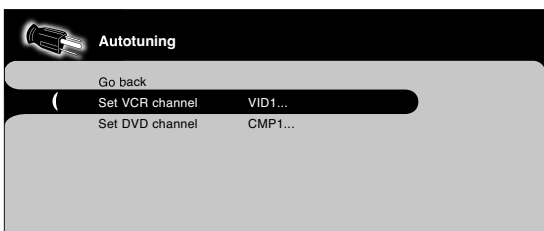

# Other Information

---

## Limited Warranty

### What your warranty covers:

- Defects in materials or workmanship.

### For how long after your purchase:

- 1 year from date of purchase for parts and labor.

### What we will do within one year:

- At our option, either (a) pay any Authorized RCA Television Service Center the labor charges, plus replacements parts, to repair your television, or (b) replace your television.
- At our option, the replacement parts or replacement television provided under the warranty may be new or refurbished.

### How you get service:

- Take your RCA television to any Authorized RCA Television Service Center and pick up when repairs are complete.
- To identify your nearest Authorized RCA Television Service Center, ask your dealer, visit [www.rca.com](http://www.rca.com), look in the Yellow Pages, or call 1-800-951-9582.
- Proof of purchase in the form of a bill of sale or receipted invoice which is evidence that the product is within the warranty period must be presented to obtain warranty service. For rental firms, proof of first rental is also required.

### What your warranty *does not* cover:

- Acts of nature, such as but not limited to lightning damage.
- Adjustment of customer controls.
- Damage from misuse or neglect.
- A unit that has been modified or incorporated into other products or is used for institutional or other commercial purposes.
- Batteries.
- Units purchased or serviced outside the U.S.A.
- Shipping damage if the unit was not packed and shipped in the manner prescribed by TTE Technology, Inc..
- Customer Instruction. (Your Owner's Manual describes how to install, adjust, and operate your unit. Any additional information should be obtained from your dealer.)

### Product Registration:

- Please complete and mail the Product Registration Card packed with your TV or register on-line at [www.rca.com](http://www.rca.com). It will make it easier to contact you should it ever be necessary. The return of the card is not required for warranty coverage.

### Limitation of Warranty:

- **THE WARRANTY STATED ABOVE IS THE ONLY WARRANTY APPLICABLE TO THIS PRODUCT. ALL OTHER WARRANTIES, EXPRESS OR IMPLIED (INCLUDING ALL IMPLIED WARRANTIES OF MERCHANTABILITY OR FITNESS FOR A PARTICULAR PURPOSE) ARE HEREBY DISCLAIMED. NO VERBAL OR WRITTEN INFORMATION GIVEN BY TTE TECHNOLOGY, INC., ITS AGENTS OR EMPLOYEES SHALL CREATE A WARRANTY OR IN ANY WAY INCREASE THE SCOPE OF THIS WARRANTY.**
- **REPAIR OR REPLACEMENT AS PROVIDED UNDER THIS WARRANTY IS THE EXCLUSIVE REMEDY OF THE CONSUMER. TTE TECHNOLOGY, INC. SHALL NOT BE LIABLE FOR INCIDENTAL OR CONSEQUENTIAL DAMAGES RESULTING FROM THE USE OF THIS PRODUCT OR ARISING OUT OF ANY BREACH OF ANY EXPRESS OR IMPLIED WARRANTY ON THIS PRODUCT. THIS DISCLAIMER OF WARRANTIES AND LIMITED WARRANTY ARE GOVERNED BY THE LAWS OF THE STATE OF INDIANA. EXCEPT TO THE EXTENT PROHIBITED BY APPLICABLE LAW, ANY IMPLIED WARRANTY OF MERCHANTABILITY OR FITNESS FOR A PARTICULAR PURPOSE ON THIS PRODUCT IS LIMITED TO THE APPLICABLE WARRANTY PERIOD SET FORTH ABOVE.**

### How state law relates to warranty:

- Some states do not allow the exclusion nor limitation of incidental or consequential damages, or limitations on how long an implied warranty lasts, so the above limitations or exclusions may not apply to you.
- This warranty gives you specific legal rights, and you also may have other rights that vary from state to state.

### If you purchased your product outside the United States:

- This warranty does not apply. See your dealer for warranty information.

**Service calls which do not involve defective materials or workmanship are not covered by this warranty. Costs of such service calls are the sole responsibility of the purchaser.**

## Care and Cleaning

CAUTION: Turn OFF your TV before cleaning.

You can clean the TV as required, using a soft lint-free cloth. Be sure to occasionally dust the ventilation slots in the cabinet to help assure adequate ventilation.

**IMPORTANT: Never use strong cleaning agents, such as ammonia-based cleaners, or abrasive powder. These types of cleaners will damage the TV.**

**The TV's screen may be cleaned with a soft, lint-free cloth as well. Take care not to scratch or mar the screen. If necessary, you may use a cloth dampened with warm water.** While cleaning do not spray liquid directly on the screen, or allow liquid to run down the screen and inside the TV. Also, never place drinks or vases with water on top of the TV. This could increase the risk of fire or shock hazard or damage to the TV.

## **FCC Information**

This equipment has been tested and found to comply with the limits for a Class B digital device, pursuant to Part 15 of the FCC Rules. These limits are designed to provide reasonable protection against harmful interference in a residential installation. This equipment generates, uses, and can radiate radio frequency energy and, if not installed and used in accordance with the instructions, may cause harmful interference to radio communications. However, there is no guarantee that interference will not occur in a particular installation. If this equipment does cause harmful interference to radio or television reception, which can be determined by turning the equipment off and on, the user is encouraged to try to correct the interference by one or more of the following measures:

- Reorient or relocate the receiving antenna.
- Increase the separation between the equipment and receiver.
- Connect the equipment into an outlet on a circuit different from that to which the receiver is connected.
- Consult the dealer or an experienced radio/TV technician for help.

This Class B digital apparatus complies with Canadian ICES-003.

---

**Visit the RCA website at [www.rca.com](http://www.rca.com)**

---

Please do not send any products to the Indianapolis address listed in this manual or on the carton. This will only add delays in service for your product.

**TTE Technology, Inc.**  
**101 West 103rd St.**  
**Indianapolis, IN 46290**

©2006 TTE Technology Inc.  
RCA and associated marks are trademarks of THOMSON S.A.  
used under license to TTE Corporation.

Printed in China

**TOCOM 16651050**