

HITACHI

Inspire the Next

LCD Flat Panel TELEVISION

Operating Guide for L47S601 & L42S601

IMPORTANT SAFETY INSTRUCTIONS	2-3
FIRST TIME USE	4-21
THE REMOTE CONTROL	22-33
ON-SCREEN DISPLAY	34-57
USEFUL INFORMATION	58-64
OPERATING GUIDE IN SPANISH	65-128
END USER LICENSE AGREEMENT FOR HITACHI DTV SOFTWARE	129-137
APPENDIXES	138-139
INDEX	140

ULTRAVISION

Important Safety Instructions



SAFETY POINTS YOU SHOULD KNOW ABOUT YOUR HITACHI LCD FLAT PANEL TELEVISION

Our reputation has been built on the quality, performance, and ease of service of **Hitachi** LCD Flat Panel televisions.

Safety is also foremost in our minds in the design of these units. To help you operate these products properly, this section illustrates safety tips which will be of benefit to you. Please read it carefully and apply the knowledge you obtain from it to the proper operation of your **Hitachi** LCD Flat Panel television.

Please fill out your warranty card and mail it to **Hitachi**. This will enable **Hitachi** to notify you promptly in the improbable event that a safety problem should be discovered in your product model.

Follow all warnings and instructions marked on this LCD Flat Panel television.



The lightning flash with arrowhead symbol, within an equilateral triangle, is intended to alert the user to the presence of uninsulated "dangerous voltage" within the product's enclosure that may be of a sufficient magnitude to constitute a risk of electric shock to a person.



The exclamation point within an equilateral triangle, is intended to alert the user to the presence of important operating and maintenance (servicing) instructions in the literature accompanying the appliance.

READ BEFORE OPERATING EQUIPMENT

Follow all warnings and instructions marked on this LCD Flat Panel television.

1. Read these instructions.
2. Keep these instructions.
3. Heed all warnings.
4. Follow all instructions.
5. Do not use this apparatus near water.
6. Clean only with a soft dry cloth.
7. Do not block any ventilation openings. Install in accordance with the manufacturer's instructions.
8. Do not install near any heat sources such as radiators, heat registers, stoves, or other apparatus (including amplifiers) that produce heat.
9. Do not defeat the safety purpose of the polarized or grounding-type plug. A polarized plug has two blades with one wider than the other. A grounding type plug has two blades and a third grounding

prong. The wide blade or the third prong are provided for your safety. If the provided plug does not fit into your outlet, consult an electrician for replacement of the obsolete outlet.

10. Protect the power cord from being walked on or pinched particularly at plugs, convenience receptacles, and the point where they exit from the apparatus.
11. Only use the attachments/accessories specified by the manufacturer.



12. Use only with the cart, stand, tripod, bracket, or table specified by the manufacturer, or sold with the apparatus. When a cart is used, use caution when moving the cart/apparatus combination to avoid injury from tip-over.

13. Unplug this apparatus during lightning storms or when unused for long periods of time.

14. Refer all servicing to qualified service personnel. Servicing is required when the apparatus has been damaged in any way, such as power-supply cord or plug is damaged, liquid has been spilled or objects have fallen into apparatus, the apparatus has been exposed to rain or moisture, does not operate normally, or has been dropped.

15. Televisions are designed to comply with the recommended safety standards for tilt and stability. Do not apply excessive pulling force to the front, or top, of the cabinet which could cause the product to overturn resulting in product damage and/or personal injury.

16. Follow instructions for wall, shelf or ceiling mounting as recommended by the manufacturer.

17. An outdoor antenna should not be located in the vicinity of overhead power lines or other electrical circuits.

18. If an outside antenna is connected to the receiver be sure the antenna system is grounded so as to provide some protection against voltage surges and built up static charges. Section 810 of the National Electric Code, ANSI/NFPA No. 70-1984, provides information with respect to proper grounding for the mast and supporting structure, grounding of the lead-in wire to an antenna discharge unit, size of grounding connectors, location of antenna discharge unit, connection to grounding electrodes and requirements for the grounding electrode.

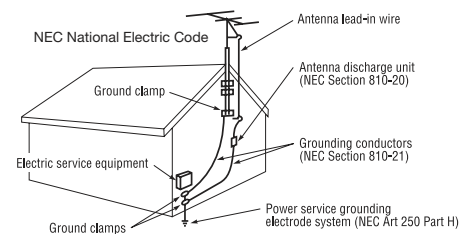

Note to the CATV system installer: This reminder is provided to call the CATV system installer's attention to Article 820-44 of the NEC that provides guidelines for proper grounding and, in particular, specifies that the cable ground shall be connected to the grounding system of the building, as close to the point of cable entry as practical.

Important Safety Instructions



Power source

This LCD television is designed to operate on 120 volts 60 Hz, AC current. Insert the power cord into a 120 volt 60 Hz outlet. The mains plug is used as the disconnect device and shall remain readily operable.

To prevent electric shock, do not use the LCD television's (polarized) plug with an extension cord, receptacle, or other outlet unless the blades and ground terminal can be fully inserted to prevent blade exposure.

Never connect the LCD television to 50 Hz, direct current, or anything other than the specified voltage.

Caution



Never remove the back cover of the LCD television as this can expose you to very high voltages and other hazards. If the television does not operate properly, unplug the LCD television and call your authorized dealer or service center.

Caution

Adjust only those controls that are covered in the instructions, as improper changes or modifications not expressly approved by **Hitachi** could void the user's warranty.

Warning

- To reduce the risk of fire or electric shock, do not expose this apparatus to rain or moisture.
- The LCD television should not be exposed to dripping or splashing and objects filled with liquids, such as vases, should not be placed on the television.
- This apparatus shall be connected to a mains socket outlet with a protective earthing connection.

Public viewing of copyrighted material

Public viewing of programs broadcast by TV stations and cable companies, as well as programs from other sources, may require prior authorization from the broadcaster or owner of the video program material.

This product incorporates copyright protection technology that is protected by U.S. patents and other intellectual property rights. Use of this copyright protection technology must be authorized, and is intended for home and other limited consumer uses only unless otherwise authorized. Reverse engineering or disassembly is prohibited.

Note

This digital television is capable of receiving analog basic, digital basic cable television programming by direct connection to a cable system providing such programming. Certain advanced and interactive digital cable services such as video-on-demand, a cable operator's enhanced program guide and data-enhanced television services may require the use of a set-top box.

For more information call your local cable company.

Note

- There are no user serviceable parts inside the LCD television.
- Model and serial numbers are indicated on back side and right side of the LCD television.

Lead/Mercury Notice

 This product contains lead and one or more non-replaceable mercury lamps. Do not put in trash. Recycle or dispose of according to applicable laws. For product recycling and disposal information, contact your local government agency or visit www.eiae.org (in USA) or www.epsc.ca (in Canada). For more information, call **1-800-HITACHI**.

Accessories

Check to make sure you have the following accessories before disposing of the packing material.

- 1 Remote Control

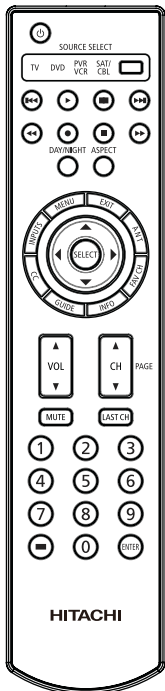

- 2 Two "AA" size, 1.5V batteries

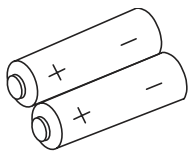

- 3 Power Cord

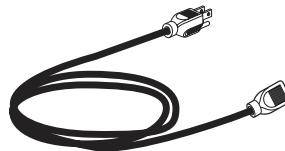

- 4 Power Swivel Cable



For U.S. models:

For optional accessories, please access our web site at: www.hitachi.us/tv

For Canada models:

For optional accessories, please access our web site at: www.hitachi.ca/tv



CAUTION:

1. Ceiling mounting is not recommended. Mounting the panel on the ceiling does not provide adequate ventilation for the electronics or proper support for the front glass panel. This LCD television product is designed for a maximum tilting angle of 45 degrees from vertical.
2. The wall mount unit for the 47" & 42" models is WM07S. Please see page 7 for important information related to the wall mount. Wall Mount unit is an optional accessory (Not Included).

- 1 Remote Control Unit CLU-4373A (Part No. HL02403).
- 2 Two "AA" size, 1.5V batteries.
- 3 Power Cord (Part No. EV01841).
- 4 Power Swivel Cable (Part No. EW08434).

REMOTE CONTROL BATTERY INSTALLATION AND REPLACEMENT

1. Open the battery cover of the remote control by pushing down and sliding the back cover off.
2. Insert two new "AA" size batteries for the remote control. When replacing old batteries, push them towards the springs and lift them out.
3. Match the batteries to the (+) and (-) marks in the battery compartment.
4. Insert the bottom of the battery, the (-) side, into the battery compartment first, push towards the springs and insert the top of the battery, the (+) side, into place. Do not force the battery into the battery compartment.
5. Replace the cover.

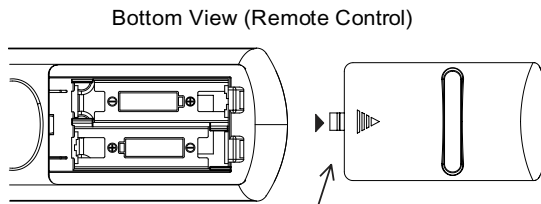

Lift up on tab to remove back cover.



CAUTION: Do not insert batteries with '+' and '-' polarities reversed as this may cause the batteries to swell or rupture resulting in leakage.

First time use

How To Set Up Your New Hitachi LCD Television

To take measures to prevent the LCD Flat Panel Television from tipping over and prevent possible injury it is important to mount the unit in a stable and flat surface.

Securing to a Wall

- Using metallic wire (two places) fasten the set to the clamping screw on the rear of the LCD Flat Panel TV as shown below.

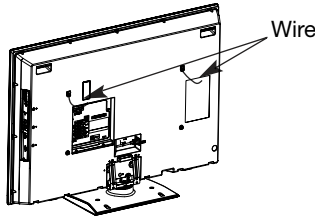

- Keep the LCD television 4 inches away from the wall except when mounted using the wall mount bracket.
- Secure the television to the wall as shown.

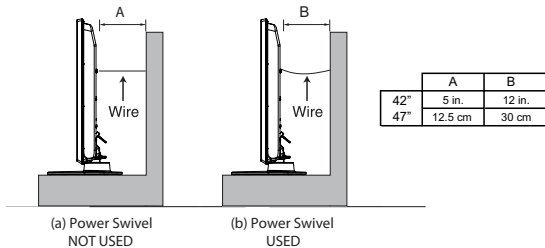

* Please adjust the wire length to avoid touching the wall when turning the TV.

- NOTES:**
- Do not block the ventilation holes of the LCD Television. Blocking the ventilation holes might cause fire or defect.
 - In case of an abnormal symptom, unplug the AC cord.
 - If you purchased the wall mount bracket option, please ask for professional installer. Do not install by yourself.
 - Install the unit at a proper area where it does not expose anyone to any danger of hitting themselves (for example their hands, head or face, etc.) against the edge of the unit and cause personal injury.
 - If the Power Swivel feature will not be used, the LCD television should be secured to the wall as shown in fig. (a).
 - If the Power Swivel feature will be used, the LCD television should be secured to the wall as shown in fig. (b).



Caution when moving the main unit

As this product is heavy, whenever it is moved, two people are required to transport it safely. Whenever the unit is moved it should be lifted forward using the top and base on both sides of the Television for stability. When moving the Television, lift the handles, then support the bottom frame as shown below.

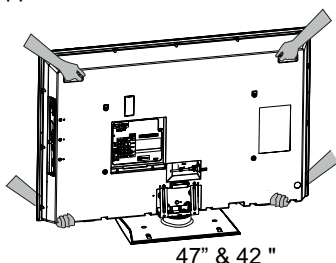

47" & 42"

ANTENNA

Unless your LCD Television is connected to a cable TV system or to a centralized antenna system, a good outdoor color TV antenna is recommended for best performance. However, if you are located in an exceptionally good signal area that is free from interference and multiple image ghosts, an indoor antenna may be sufficient.

LOCATION

Select an area where sunlight or bright indoor illumination will not fall directly on the picture screen. Also, be sure that the location selected allows a free flow of air to and from the perforated back cover of the set. In order to prevent an internal temperature increase, maintain a space of 10 cm (4 inches) from the sides/back of the Television, and 30 cm (12 inches) from the top of the television to the ceiling. To avoid cabinet warping, cabinet color changes, and increased chance of set failure, do not place the TV where temperatures can become excessively hot, for example, in direct sunlight or near a heating appliance, etc.

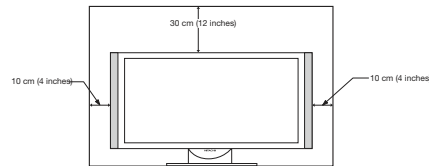

CONNECT POWER SWIVEL CABLE

Connect one end of cable to the swivel slot of the LCD Rear Panel. Connect the other end to swivel slot of the Table Top Stand. For more detail information, please refer to next page installation instruction.

TURNING ANGLE

The maximum turning angle is 30° (left and right). Do not place any objects on the path of the monitor when using the power swivel feature.

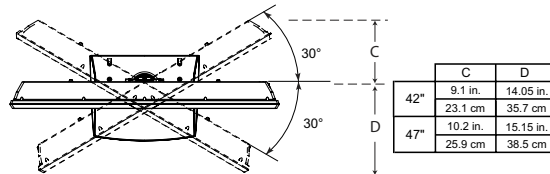

How to set up your new Hitachi LCD Television

AC CORD AND POWER SWIVEL CABLE INSTALLATION INSTRUCTION

The AC cord and power swivel cable provided with your new LCD Flat Panel Television need to be installed correctly to avoid their disconnection when rotating the TV on its Table top stand.

Located on the back of the TV are 2 plastic clamps to hold the AC cord and power swivel cable. Please follow the instructions below.

- 1 Pass the AC cord through Clamp #1 and connect it to the TV. Pull on the clamp to tighten the AC cord to the TV.
- 2 Connect power swivel cable on one end to the swivel slot of the LCD Rear Panel. Connect the other end to the swivel slot of the Table Top Stand Base.
- 3 The AC cord, power swivel cable and the signal cables can all be held together with Clamp #2.

- 1 Clamp #1 : Pass the AC cord through this clamp ; then pull the clamp to tighten the AC cord to the TV.

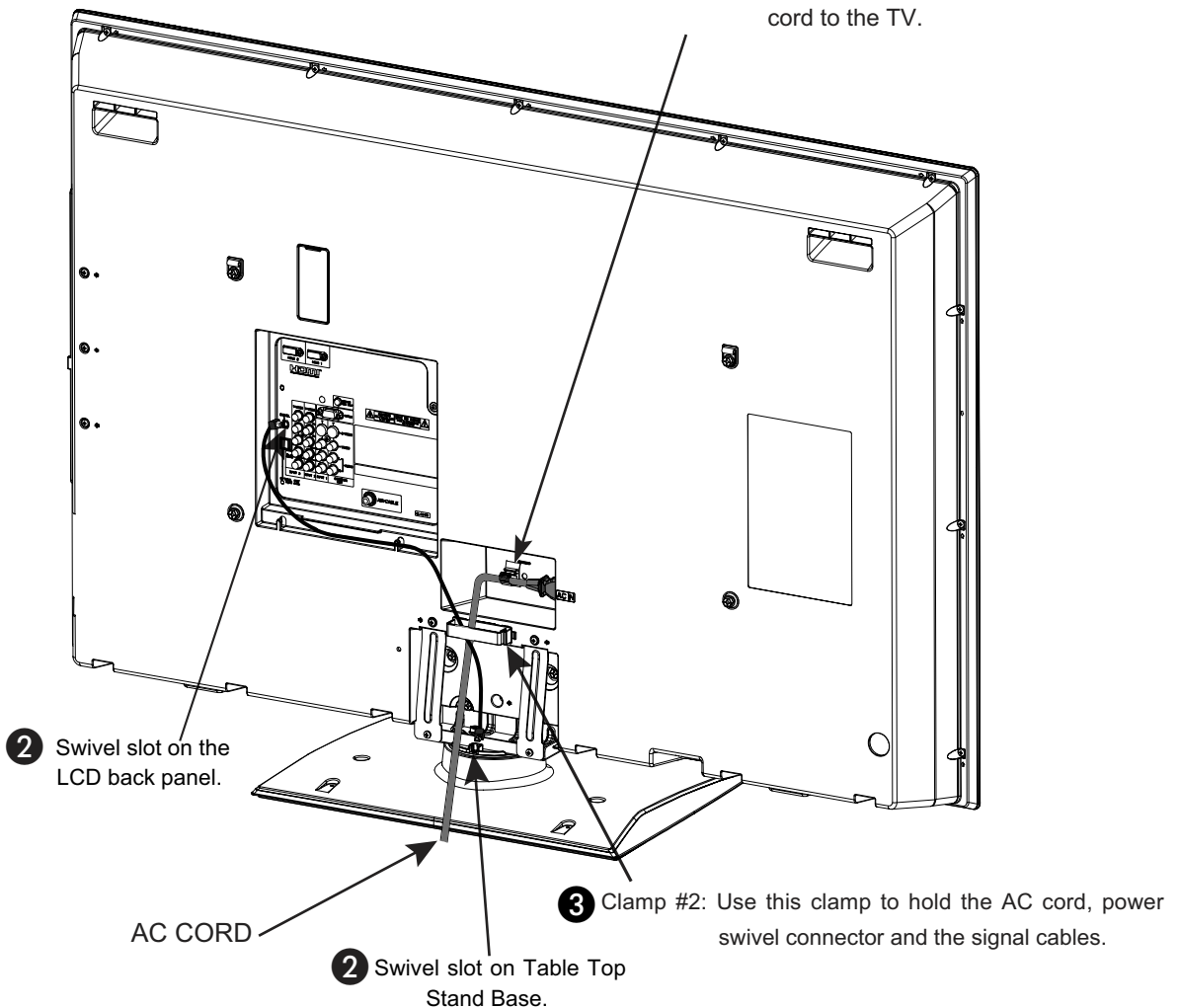

How to set up your new HITACHI LCD Television

SETTING FOR WALL MOUNTING

STEP (1) :

Please locate the STAND METAL SUPPORTS on the back of the TV . These metals is use to hold the TV and the Base ; so it needs to remove 4 screws from the STAND METAL in order to separate the TV from the Base.

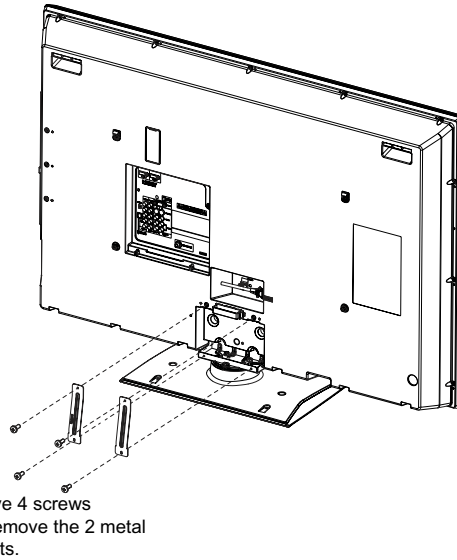
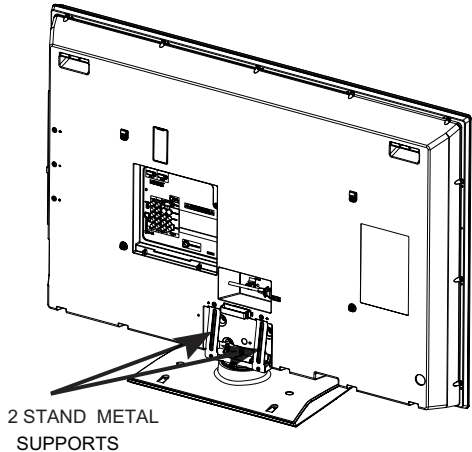

STEP (2):

Now please remove the 5 screws of the STAND metal from the TV, now the TV STAND can be separated from the TV. For dimensions of the WALL MOUNT assembly please refer to page 62.

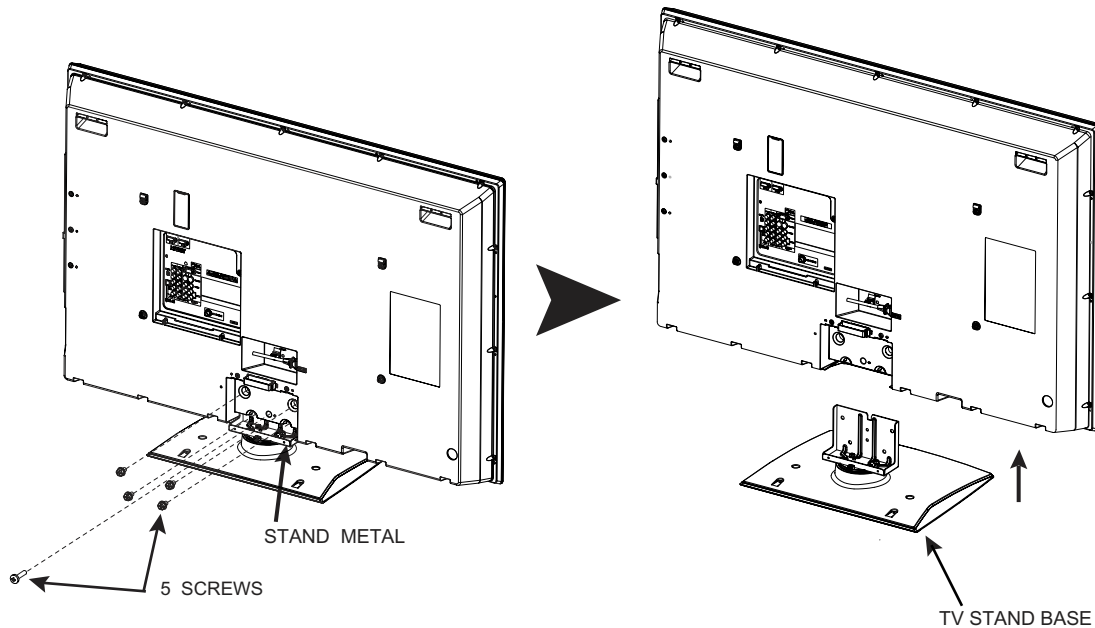

For Model L47S601 & L42S601

CAUTION- This LCD Flat Panel for use only with Hitachi **WM07S** Wall Mount. Use with other Wall Mount is capable of resulting in instability causing possible injury.

NOTE: Use the specified WALL MOUNT unit for the LCD TV depending on the size of your TV. Please access our web site at: www.hitachi.uslvtv (US) or www.hitachi.caltv (CAN) for recommended accessories for your TV.

How to set up your new HITACHI LCD Television

VIEWING

The best picture is seen by sitting directly in front of the TV and about 10 to 18 feet from the screen.

During daylight hours, reflections from outside light may appear on the screen. If so, drapes or screens can be used to reduce the reflection or the TV can be located in a different section of the room.

If the TV's audio output will be connected to a Hi-Fi system's external speakers, the best audio performance will be obtained by placing the speakers equidistant from each side of the receiver cabinet and as close as possible to the height of the picture screen center. For best stereo separation, place the external speakers at least four feet from the side of the TV, place the surround speakers to the side or behind the viewing area. Differences in room sizes and acoustical environments will require some experimentation with speaker placement for best performance.

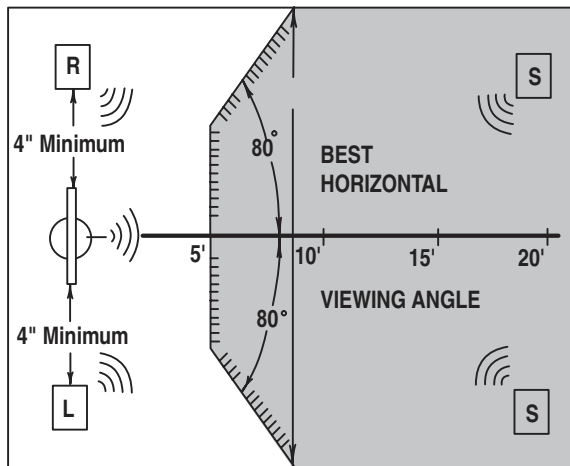

ANTENNA CONNECTIONS TO REAR JACK PANEL

VHF (75-Ohm) antenna/CATV (Cable TV)

When using a 75-Ohm coaxial cable system, connect **CATV** coaxial cable to the AIR/CABLE (75-Ohm) terminal. Or if you have an antenna, connect the coaxial cable to the same AIR/CABLE terminal.

VHF (300-Ohm) antenna/UHF antenna

When using a 300-Ohm twin lead from an outdoor antenna, connect the **VHF** or **UHF** antenna leads to screws of the **VHF** or **UHF** adapter. Plug the adapter into the antenna terminal on the TV.

When both VHF and UHF antennas are connected

Attach an optional antenna cable mixer to the TV antenna terminal, and connect the cables to the antenna mixer. Consult your dealer or service store for the antenna mixer.

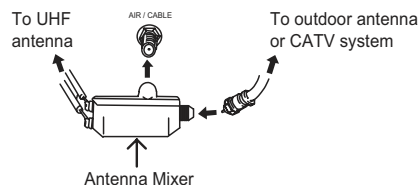
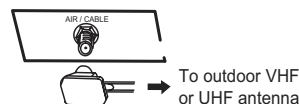
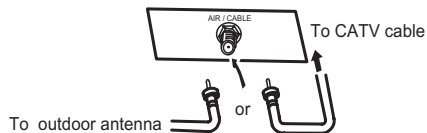

NOTE: Connecting a 300-Ohm twin lead connector may cause interference. Using a 75-Ohm coaxial cable is recommended.

Hook-up Cables and Connectors

First time use

Most video/audio connections between components can be made with shielded video and audio cables that have phono connectors. For best performance, video cables should use 75-Ohm coaxial shielded wire. Cables can be purchased from most stores that sell audio/video products. Below are illustrations and names of common connectors. Before purchasing any cables, be sure of the output and input connector types required by the various components and the length of each cable.

300-Ohm Twin Lead Cable

This outdoor antenna cable must be connected to an antenna adapter (300-Ohm to 75-Ohm).

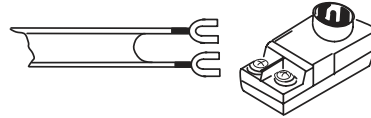

Phono or RCA Cable

Used on all standard video and audio cables which connect to inputs and outputs located on the television's rear jack panel and side control panel.



"F" Type 75-Ohm Coaxial Antenna

For connecting RF signals (antenna or cable TV) to the antenna jack on the television.



S-Video (Super Video) Cable

This connector is used on camcorders, VCRs and laser-disc players with an S-Video feature in place of the standard video cable to produce a high quality picture.

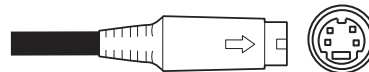

Optical Cable

This cable is used to connect to an audio amplifier with an Optical Audio In jack. Use this cable for the best sound quality.

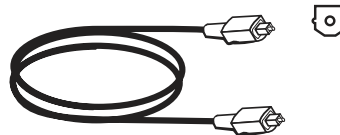

HDMI Cable

This cable is used to connect your external devices such as Set-Top-Boxes or DVD players equipped with an HDMI output connection to the TV's HDMI input.

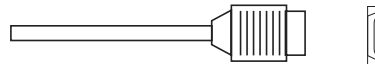

Stereo Cable (3.8mm plug to 3.5mm plug)

Used on all standard video and audio cable which connect to inputs and outputs located on the rear jack panel and side control panel.

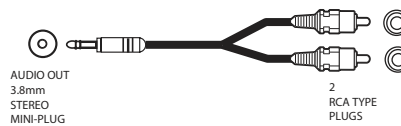

Power Swivel Cable (Provided)

This cable is used to connect the swivel stand to the rear panel of the LCD Television.



Quick Reference Remote Control Buttons and Functions

In addition to controlling all of the functions on your HITACHI LCD TV, the new remote control is designed to operate different types of devices, such as, DVD Players, CBL (Cable Boxes), set-top-boxes, satellite receivers, and VCRs. The remote control must be programmed to control the chosen device. Please see pages 22-33 for a complete description of all features and programming of the Remote Control.

First time use

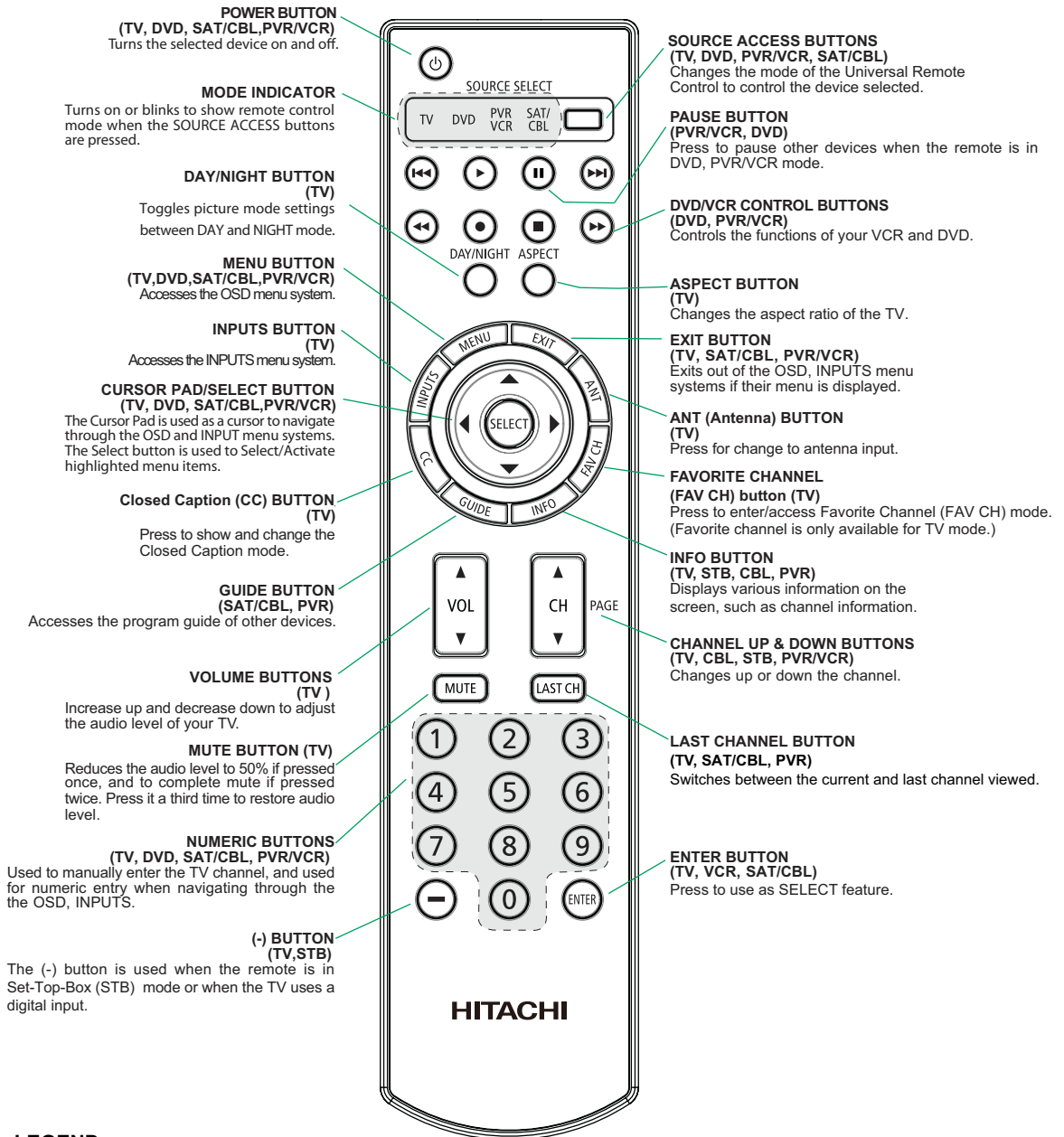

LEGEND

- TV – Television
- CBL – Cable Box
- SAT – Satellite
- PVR – Video Recorder/Player
- DVD – Digital Video Disc Player
- VCR – Videocassette Recorder

NOTES: 1. The TV's remote control sensor is located on the right bottom portion of the TV screen. To control TV functions, please point the remote control directly at the remote control sensor for best results.
2. VCR precode is included in the PVR mode.

Side Panel Controls

First time use

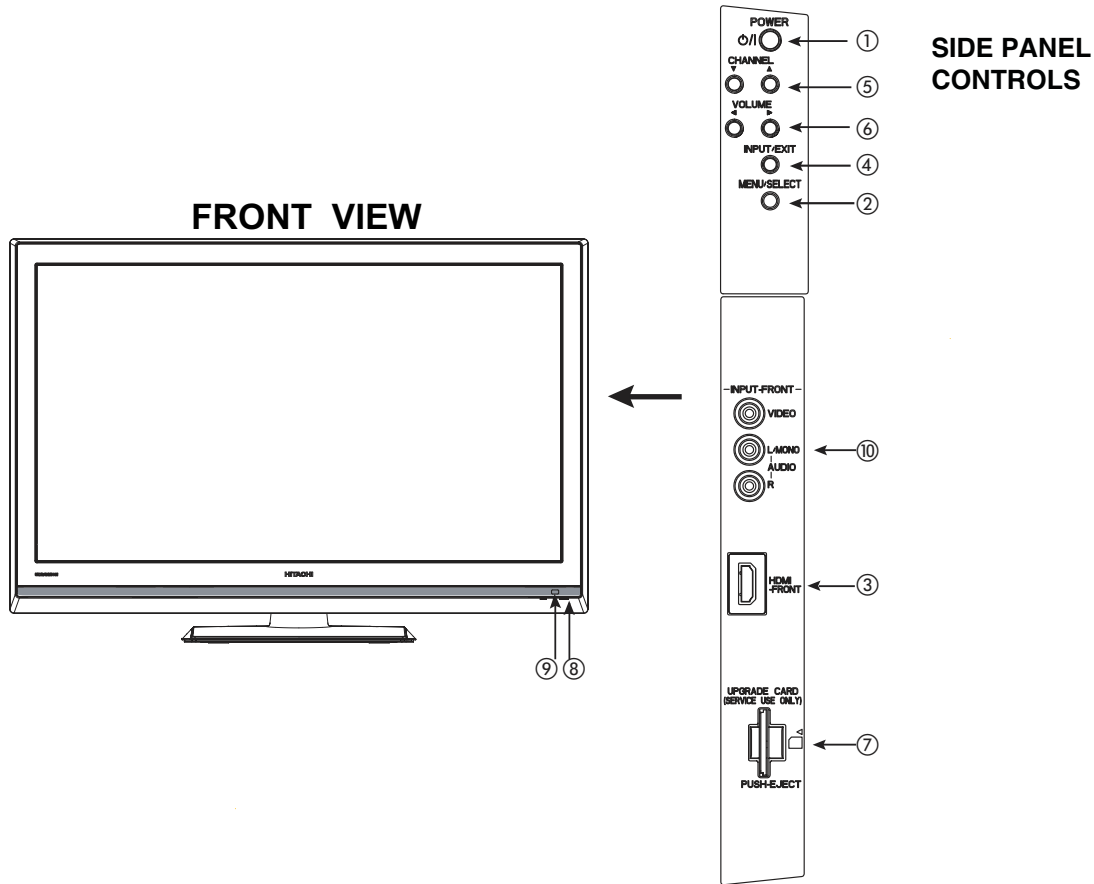

① SIDE POWER button

Press this button to turn the LCD Television ON/OFF. It can also be turned ON/OFF by remote control. The "MAIN POWER" can only be turn OFF by unplugging the power cord from the outlet. After this button is pressed to turn ON the set, the function of this button will not be available for a short period of time until the picture appears on the TV screen.

NOTE: When the TV is unplugged, the clock will stop and may eventually reset itself.

② MENU/SELECT button

This button allows you to enter the MENU, making it possible to set TV features to your preference without using the remote. This button also serves as the SELECT button when in MENU mode.

③ HDMI-FRONT

Use the side HDMI input for external devices such as Set-Top-Boxes or DVD players equipped with an HDMI output connection (see page 14 for reference).

④ INPUT/EXIT button

Press this button to access the INPUT menu. Press again to exit the MENU mode.

⑤ CHANNEL selector

Press these buttons until the desired channel appears in the top right corner of the TV screen. These buttons also serve as the cursor down (▼) and up (▲) buttons when in MENU mode.

⑥ VOLUME level

Press these buttons to adjust the sound level. The volume level will be displayed on the TV screen. These buttons also serve as the cursor left (◀) and right (▶) buttons when in MENU mode.

⑦ Upgrade Card

This card slot is for future software upgrades. Hitachi will notify you if a software upgrade is required for your TV. In order to receive written notification, please complete and return your warranty card.

Side Panel Controls

⑧ POWER light indicator

To turn the TV ON, press the power button located on the right side of the TV set. A red stand-by indicator lamp located on the lower right corner of the front bezel is illuminated. The LCD TV is now ready for remote ON/OFF operation.

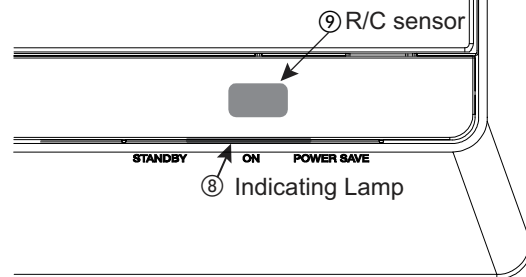

Indicating Lamp	Power Status	Operating
Off	OFF.	When the TV set is unplugged from AC line.
Lights Red	OFF. (Stand-by)	When the TV set is plugged to the AC line.
Lights Blue	On	TV POWER is ON ; picture is shown.
Lights Orange	Off (Power Saving)	TV POWER is ON with no signal input except antenna (no sync. signal).
Blinking Blue	On	When TV receives the IR signal from R/C.

⑨ REMOTE CONTROL sensor

Point your remote at this area when selecting channels, adjusting volume, etc.

⑩ INPUT- FRONT JACKS

INPUT- FRONT provide composite Video jacks for connecting equipment with this capability, such as a DVD player or Camcorders.

- NOTES:**
1. Your HITACHI LCD TV will appear to be turned OFF (lights orange) if there is no video input when INPUT : 1, 2, 3, Front and HDMI 1, 2, Front. Check the Power Light to make sure the TV is turned off or in Stand-by mode (lights red) when not in use.
 2. Remote Control can not turn ON/OFF the "MAIN POWER" of the TV.

Rear Panel Connections

① Antenna Input

To switch between Cable and Air input, go to the Channel Manager option to change the signal source CABLE or AIR.

② Audio/Video Inputs 1, 2 and 3

By using the INPUTS button, the CURSOR PAD (▲ and ▼), and the SELECT button or CURSOR PAD ► of the remote control, you can select each video source. Use the audio and video inputs to connect external devices, such as VCRs, camcorders, laserdisc players, DVD players etc. (if you have mono sound, insert the audio cable into the left audio jack).

③ MONITOR OUT & AUDIO OUT

These jacks provide fixed audio and video signals (CABLE/AIR or INPUTS) which are used for recording. Use the S-VIDEO output for high quality video output. Component signal to Input 2 and 3, and HDMI inputs will not have monitor output.

④ Optical Out (Digital Audio)

This jack provides Digital Audio Output for your audio device that is Dolby® Digital and PCM compatible, such as an audio amplifier.

NOTE: *Manufactured under license from Dolby Laboratories. "Dolby" and the double-D symbol are trademarks of Dolby Laboratories.

⑤ S-VIDEO Input 1

Input 1 provide S-VIDEO (Super Video) jacks for connecting equipment with S-VIDEO output capability.

NOTE: 1. You may use VIDEO or S-VIDEO inputs to connect to INPUT 1 , but only one of these inputs may be used at a time.
2. S-VIDEO output may be used for recording, only when the input is of S-VIDEO type.

⑥ HDMI 1, 2 (High Definition Multimedia Interface)

ABOUT HDMI – HDMI is the next-generation all digital interface for consumer electronics. **HDMI** enables the secure distribution of uncompressed high-definition video and multi-channel audio in a single cable. Because digital television (DTV) signals remain in digital format, **HDMI** assures that pristine high-definition images retain the highest video quality from the source all the way to your television screen.

Use the **HDMI** input for your external devices such as Set-Top-Boxes or DVD players equipped with an **HDMI** output connection.

HDMI, the **HDMI** logo and High-Definition Multimedia Interface are trademarks or registered trademarks of **HDMI** Licensing LLC.

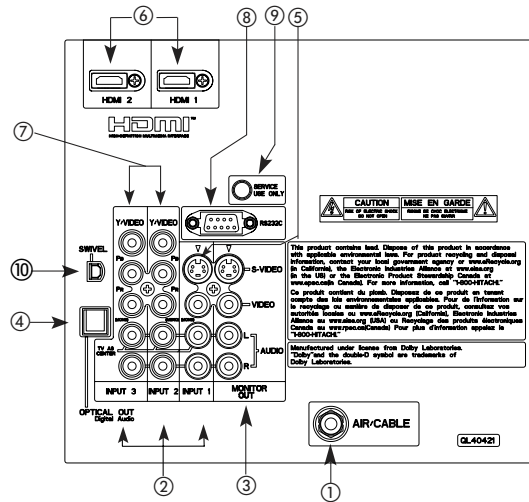

NOTE: 1. The HDMI input is not intended for use with personal computers.
2. Only DTV formats such as 1080p, 1080i, 720p, 480i and 480p are available for HDMI input.

⑦ Component: Y-PBPR Inputs

INPUTS 2 and 3 provide Y-PBPR jacks for connecting equipment with this capability, such as a DVD player or Set Top Box. You may use composite video signal for both inputs.

NOTE: 1. Do not connect composite VIDEO and S-VIDEO to INPUT 1 at the same time. S-VIDEO has priority over VIDEO input.
2. Your component outputs may be labeled Y, B-Y, and R-Y. In this case, connect the components B-Y output to the TV's P_B input and the components R-Y output to the TV's P_R input.
3. Your component outputs may be labeled Y-CBCR. In this case, connect the component CB output to the TV's P_B input and the component CR output to the TV's P_R input.
4. It may be necessary to adjust TINT to obtain optimum picture quality when using the Y-P_BPR inputs (see page 36).
5. To ensure no copyright infringement, the MONITOR OUT output will be abnormal, when using the Y-P_BPR jacks and HDMI Input.
6. INPUT 2 , and 3 (YVIDEO) can be used for composite video and component video input.

⑧ For Special AV control use only.

⑨ For Factory use only.

⑩ Power Swivel Connector

Connect from here the Power Swivel cable (provided) to the Table Top Stand Base swivel slot.

Connecting External Video Sources

The SIDE panel jacks are provided as a convenience to allow you to easily connect HDMI or DVI signals from a DVD, Set Top Box , Video Game as shown in the following examples (When connecting DVI signal it will need to connect the audio output into the side Audio Input jacks) :

A) Connecting HDMI signal.

SIDE INPUT PANEL



Note : Special device cables will be according to the own device specifications.

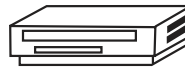

HDMI DIGITAL OUTPUT CAPABILITY
DVD , Set Top Box,
Video Game Console.

B) Connecting DVI signal.

SIDE INPUT PANEL



DVI to HDMI Cable

Back of
HDTV Set-Top-Box or
DVD Player

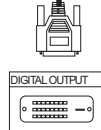

Note : Special device cables will be according to the own device specifications.

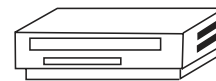

DVI DIGITAL OUTPUT CAPABILITY
DVD , Set Top Box,
Video Game Console.

NOTE: 1. Completely insert connection cord plugs when connecting to side panel jacks. If you do not, the played back picture may be abnormal.

Connecting External Video Sources

The SIDE panel jacks are provided as a convenience to allow you to easily connect a camcorder , DVD, Video Game and a VCR as shown in the following examples:

SIDE INPUT PANEL

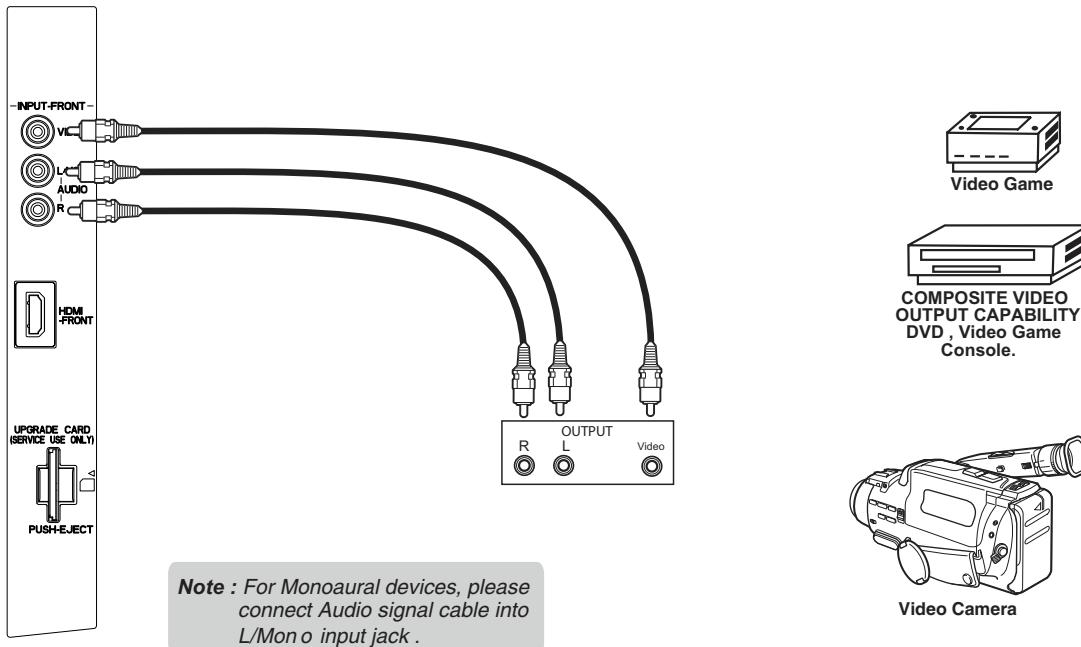

Note : For Monoaural devices, please connect Audio signal cable into L/Mon o input jack .

Note : Special device cables will be according to the own device specifications.

NOTE:1. Completely insert connection cord plugs when connecting to side panel jacks. If you do not, the played back picture may be abnormal.

The exact arrangement you use to connect the VCR, camcorder, laserdisc player, DVD player, or HDTVSet Top Box to your LCD TV is dependent on the model and features of each component. Check the owner's manual of each component for the location of video and audio inputs and outputs.

The following connection diagrams are offered as suggestions. However, you may need to modify them to accommodate your particular assortment of components and features. For best performance, video and audio cables should be made from coaxial shielded wire.

Before Operating External Video Source

Connect an external source to one of the INPUT terminals, then press the INPUTS button to show the INPUTS menu. Use the CURSOR PAD (▲ and ▼) to select the Input of your choice. Then press the SELECT button or the CURSOR PAD ► to confirm your choice (see page 25).

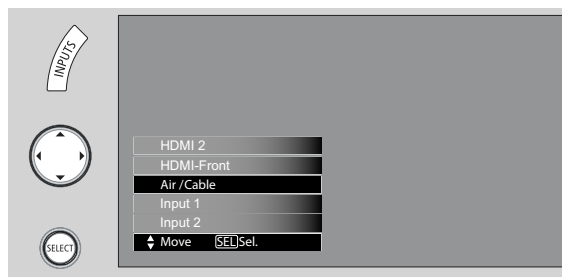

Rear Panel Connections

First time use

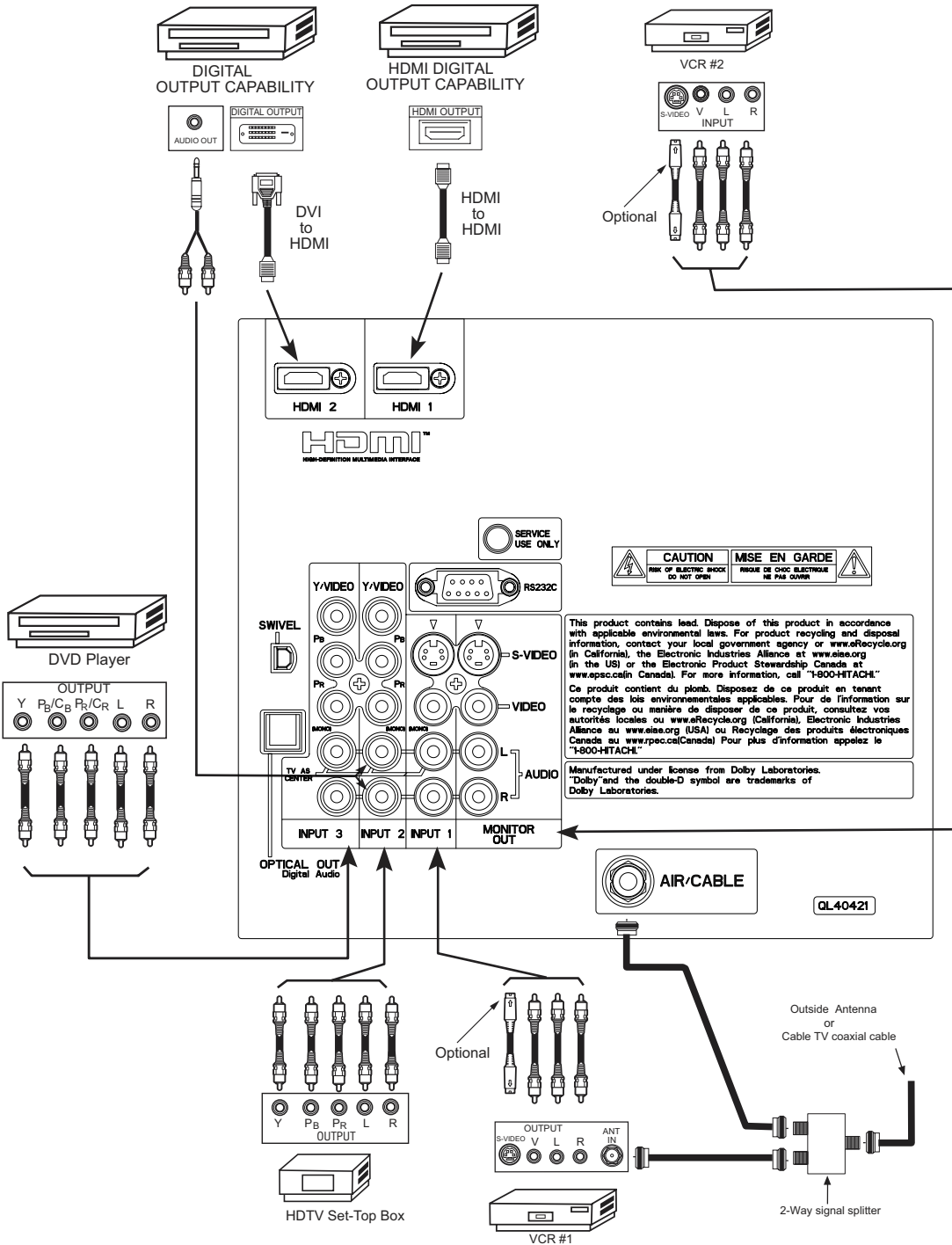

NOTE: Cables are optional, except when specified.

Tips on Rear Panel Connections

- S-VIDEO, Y-PbPr, or HDMI connections are provided for high performance laserdisc players, VCRs etc. that have this feature. Use these connections in place of the standard video connection if your device has this feature.
- If your device has only one audio output (mono sound), connect it to the left audio jack on (L/(MONO)) the Rear Panel.
- Refer to the operating guide of your other electronic equipment for additional information on connecting your hook-up cables.
- A single VCR can be used for VCR #1 and VCR #2, but note that a VCR cannot record its own video or line output (INPUT: 1 in the example on page 16). Refer to your VCR operating guide for more information on line input-output connections.
- Connect only 1 component (VCR, DVD player, camcorder, etc.) to each input jack.
- COMPONENT: Y-P_BP_R (Input 2 & 3) connections are provided for high performance components, such as DVD players and set-top-boxes. Use these connections in place of the standard video connection if your device has this feature.
- Your component outputs may be labeled Y, B-Y, and R-Y. In this case, connect the components B-Y output to the TV's P_B input and the components R-Y output to the TV's P_R input.
- Your component outputs may be labeled Y-C_BC_R. In this case, connect the components C_B output to the TV's P_B input and the components C_R output to the TV's P_R input.
- It may be necessary to adjust TINT to obtain optimum picture quality when using the Y-P_BP_R inputs. (See page 36).
- To ensure no copyright infringement, the MONITOR OUT output will be abnormal, when using the Y-PbPr and HDMI input jacks.
- Input HDMI 1, HDMI 2 or HDMI FRONT can accept HDMI signal.
- S-VIDEO monitor output may be used for recording only when the input is of S-VIDEO type.
- When using a HDMI input from a Set-Top-Box, it is recommended to use a 1080p, 1080i or 720p input signal.
- When HDMI input a 1080p signal, it is recommended that the length of the cable be less than 5 meters.

INSTALLATION RECOMMENDATION:

- 1. Video signals fed through a VCR may be affected by copyright protection systems and the picture will be distorted on the television.**
- 2. Connecting the television directly to the Audio /Video output of a Set-Top-Box will assure a more normal picture.**

Connecting External Video Sources

CONNECTING A VIDEO AND STEREO AUDIO SOURCE TO INPUT1 ~ INPUT-FRONT

1. Connect the cable from the VIDEO OUT of the VCR or the laserdisc player to the INPUT (VIDEO) jack, as shown on the Rear Panel to the right.
2. Connect the cable from the AUDIO OUT R of the VCR or the laserdisc player to the INPUT (AUDIO/R) jack.
3. Connect the cable from the AUDIO OUT L of the VCR or the laserdisc player to the INPUT (AUDIO/L) jack.
4. Press the INPUTS button, then select INPUT 1 2,3 or Front from the INPUTS menu to view the program from the VCR or laserdisc player.
5. Select CABLE or AIR from the INPUTS menu or ANT key from the R/C to return to the last channel tuned.

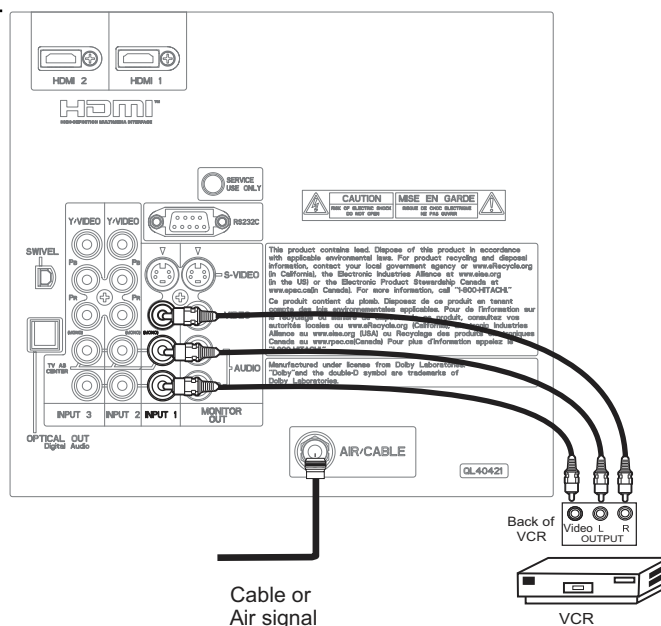

- NOTE:**
1. Completely insert the connection cord plugs when connecting to rear panel jacks. The picture and sound that is played back will be abnormal if the connection is loose.
 2. A single VCR can be used for VCR #1 and VCR #2 (see page 16) but note that a VCR cannot record its own video or line output. Refer to your VCR operating guide for more information on line input-output connections.
 3. When INPUT 2 or 3 are used, it is necessary to connect the video output of the device to the Y/VIDEO input jack of the TV.

CONNECTING AN S-VIDEO AND STEREO AUDIO SOURCE TO INPUT 1

1. Connect the cable from the S-VIDEO OUT of the S-VHS VCR or the laserdisc player to the INPUT (S-VIDEO) jack, as shown on the Rear Panel to the right.
2. Connect the cable from the AUDIO OUT R of the VCR or the laserdisc player to the INPUT (AUDIO/R) jack.
3. Connect the cable from the AUDIO OUT L of the VCR or the laserdisc player to the INPUT (AUDIO/L) jack.
4. Press the INPUTS button, then select INPUT 1 from the INPUTS menu to view the program from the VCR or laserdisc player.
5. Select CABLE or AIR from the INPUTS menu or ANT key from the R/C to return to the last channel tuned.

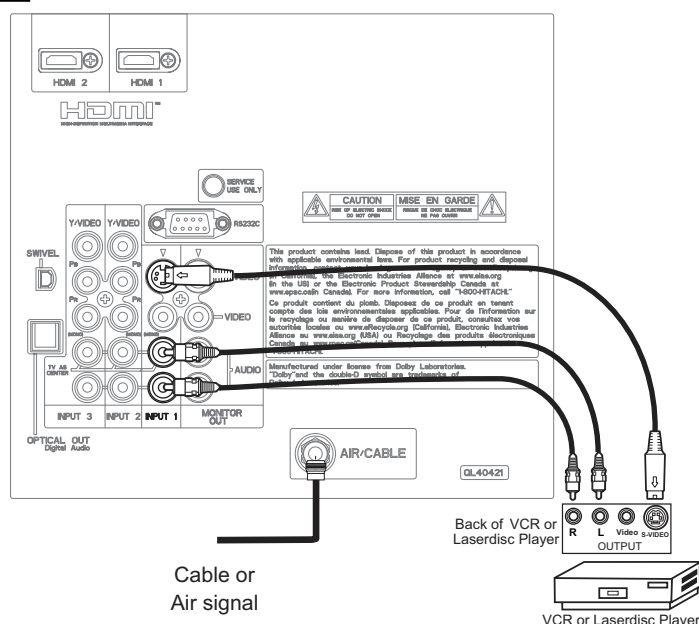

- NOTE:**
1. Completely insert the connection cord plugs when connecting to rear panel jacks. The picture and sound that is played back will be abnormal if the connection is loose.
 2. A single VCR can be used for VCR #1 and VCR #2 (see page 16), but note that a VCR cannot record its own video or line output. Refer to your VCR operating guide for more information on line input-output connections.

Connecting External Video Sources

CONNECTING A COMPONENT SOURCE WITH HDMI OR DVI CAPABILITY TO HDMI 1, HDMI 2 OR HDMI FRONT

1. Connect the HDMI or DVI to HDMI connection cable from the output of the HDTV set top box or DVD player to the HDMI input as shown on the Rear panel below.
2. With DVI output, connect the cable from the AUDIO OUT R of the HDTV set top box or DVD player to the INPUT (AUDIO/R) jack as shown on the Rear Panel below.
3. With DVI output, connect the cable from the AUDIO OUT L of the HDTV set top box or DVD player to the INPUT (AUDIO/L) jack as shown on the Rear Panel below.
4. Press the INPUTS button, then select HDMI 1, 2 or FRONT to view the program from the HDTV SET TOP BOX or DVD player.
5. Select CABLE or AIR from the INPUTS menu or ANT key from the R/C to return to the last channel viewed.

- NOTE:**
1. Completely insert the connection cord plugs when connecting to rear panel jacks. The picture and sound that is played back will be abnormal if the connection is loose.
 2. The HDMI input on HDMI 1, 2 and FRONT contains the copy protection system called High-bandwidth Digital Content Protection (HDCP). HDCP is a cryptographic system that encrypts video signals when using HDMI connections to prevent illegal copying of video contents.
 3. HDMI is not a "NETWORK" technology. It establishes a one-way point-to-point connection for delivery of uncompressed video to a display.
 4. The connected digital output device controls the HDMI interface so proper set-up of device user settings determines final video appearance.
 5. When using a DVI to HDMI cable, connect the Audio Out L and R cables at the same INPUT (1, 2 or Front) as your HDMI INPUT(1, 2 or Front). (For HDMI-FRONT see page 14 for reference).

HDMI input

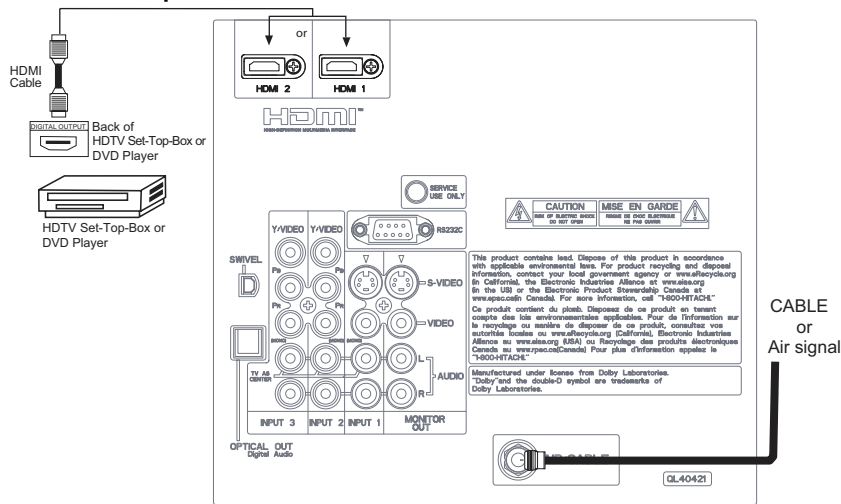

DVI to HDMI Input

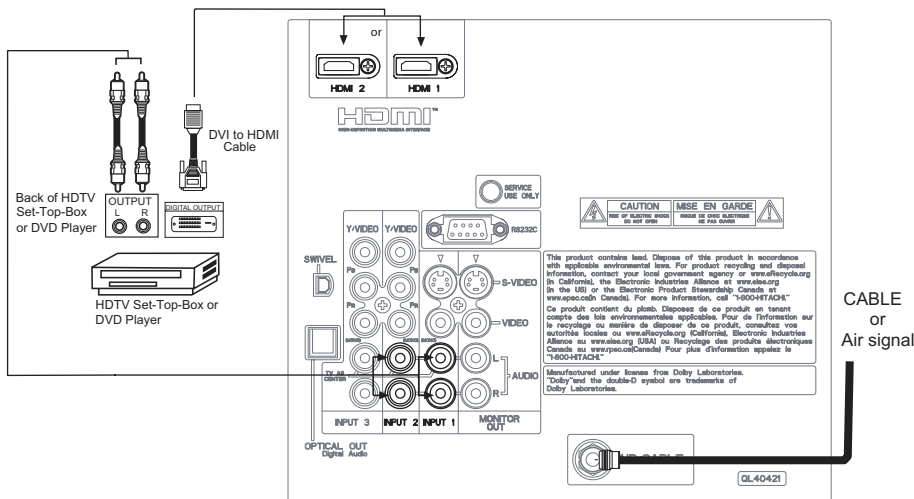

Connecting External Audio/Video Devices

CONNECTING A COMPONENT AND STEREO AUDIO SOURCE TO INPUT 2 or 3 :Y-PbPr.

1. Connect the cable from the Y OUT of the Laserdisc/DVD player or HDTV set top box to the INPUT (Y) jack, as shown on the Rear panel below.
2. Connect the cable from the P_B/C_B OUT or B-Y OUT of the Laserdisc/DVD player or HDTV set top box to the INPUT (P_B) jack.
3. Connect the cable from the P_R/C_R OUT or R-Y OUT of the Laserdisc/DVD player or HDTV set top box to the INPUT (P_R) jack.
4. Connect the cable from the AUDIO OUT R of the Laserdisc/DVD player or HDTV set top box to the INPUT (AUDIO/R) jack.
5. Connect the cable from the AUDIO OUT L of the Laserdisc/DVD player or HDTV set top box to the INPUT (AUDIO/L) jack.
6. Press the INPUTS button, then select INPUT 2 or 3 from the INPUTS menu to view the program from the Laserdisc/DVD player or HDTV set top box.
7. Select CABLE, AIR or ANT key from the R/C to return to the last channel tuned.

NOTE: 1. Completely insert the connection cord plugs when connecting to rear panel jacks. The picture and sound that is played back will be abnormal if the connection is loose.
2. See page 17 for tips on REAR PANEL CONNECTIONS.

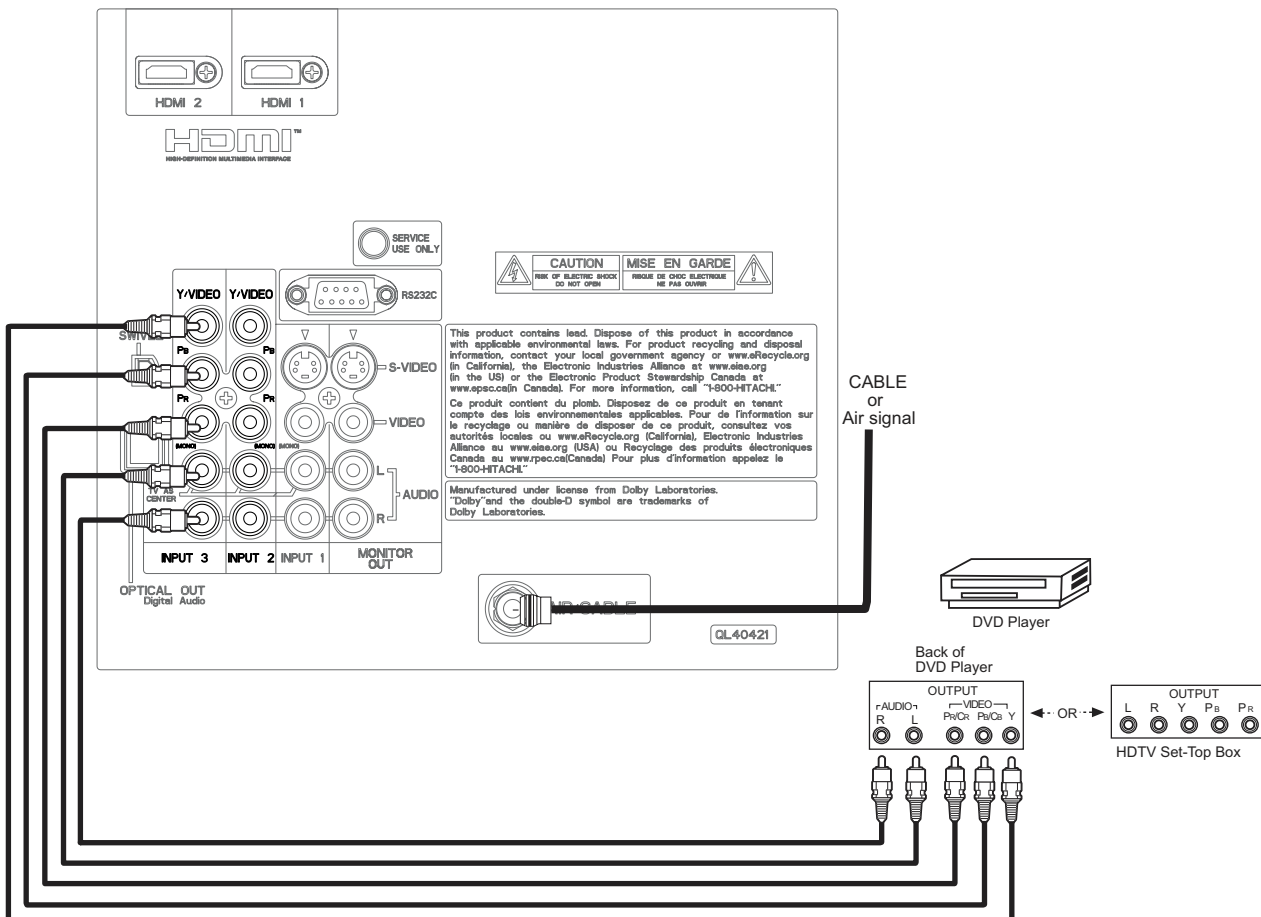

Connecting External Audio/Video Devices

CONNECTING A VIDEO AND MONAURAL AUDIO SOURCE TO INPUT 1 ~ FRONT INPUT

1. Connect the cable from the VIDEO OUT of the VCR or the laserdisc player to the INPUT (VIDEO) jack, as shown on the Rear Panel on the right.
2. Connect the cable from the AUDIO OUT of the VCR or the laserdisc player to the INPUT (MONO)/L(AUDIO) jack.
3. Press the INPUTS button, then select INPUT 1 2,3 or Front from the INPUTS menu to view the program from the VCR or the laserdisc player.
4. Select CABLE or AIR from the INPUTS menu or ANT key from the R/C to return to the previous channel. *(For INPUT FRONT please see page 15 for reference).*

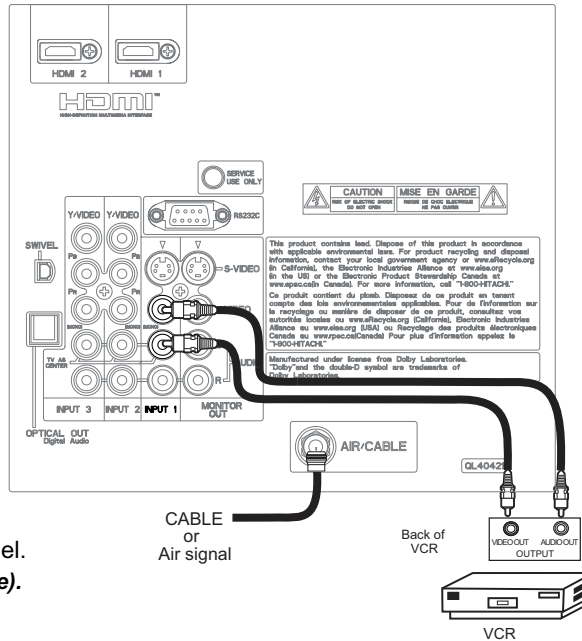

CONNECTING AN EXTERNAL AUDIO AMPLIFIER

To monitor the audio level of the LCD TV to an external audio amplifier, connect the system as shown on the right. The "OPTICAL OUT" from the Rear Panel is a fixed output. The Volume of the amplifier is controlled by the amplifier, not by the LCD Television. The OPTICAL OUT terminal outputs all audio sources with Optical IN capability.

1. Connect an optical cable from the Optical out to the Optical input of a separate Stereo System Amplifier as shown on the Rear Panel on the right.

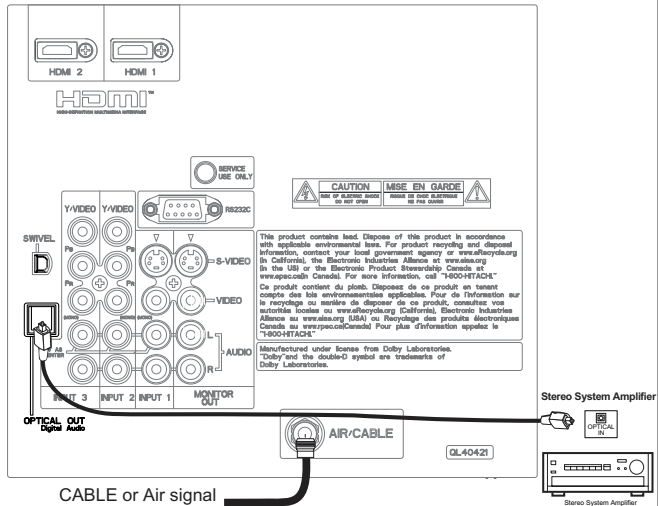

CONNECTING MONITOR OUT

The MONITOR OUT terminal outputs video and audio of CABLE/AIR and INPUTS 1, 2, 3 and Front. It does not output component and HDMI video.

1. Connecting S-Video:
Connect the cable from the S-VIDEO OUT of the Rear Panel to the INPUT (S-VIDEO) jack, of the VCR or Laserdisk player.
- Connecting Video:
Connect the cable from the VIDEO INPUT of the VCR or the laserdisc player to the VIDEO out jack on the TV Rear Panel.
2. Connect the cable from the AUDIO IN R of the VCR or the laserdisc player to the OUTPUT (AUDIO/R) jack on the TV Rear Panel.
3. Connect the cable from the AUDIO IN L of the VCR or the laserdisc player to the OUTPUT (AUDIO/L) jack on the TV Rear Panel.

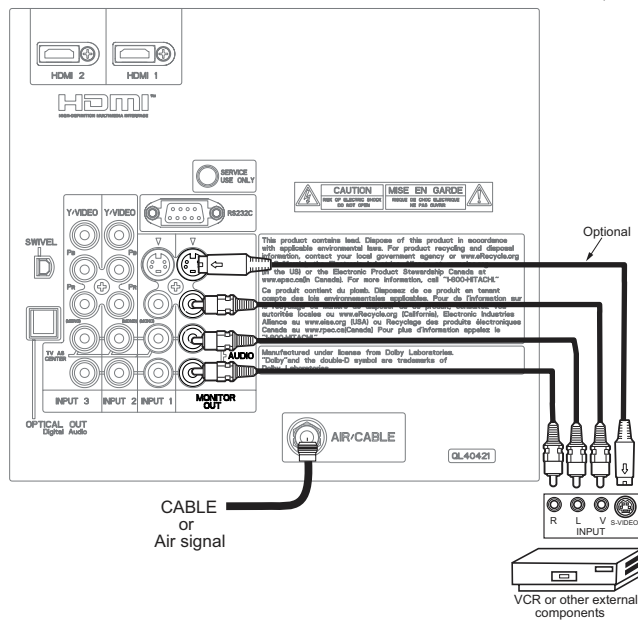

NOTE: When making video connections, connect S-Video only or Video only. If both are connected, S-Video takes priority.

The Remote Control

In addition to controlling all the functions on your Hitachi LCD TV, the new remote control is designed to operate different types of VCRs, cable boxes, set-top-boxes, satellite receivers, DVD players, and other audio/video equipment with one touch. Basic operation keys are grouped together in one area.

To operate your LCD TV, select **TV** by pressing the Source button of the Source Select on the remote. The **TV** mode indicator will blink, indicating that the remote will now control your television.

To operate your VCR/PVR (Personal Video Recorder), select **PVR/VCR** by pressing the Source button of the Source Select on the remote. The **PVR/VCR** mode indicator will blink, indicating that the remote will now control your VCR/PVR (see page 30 for instructions on how to program the remote to control your VCR/PVR).

To operate your cable box, select **SAT/CBL** by pressing the Source button of the Source Select on the remote. The **SAT/CBL** mode indicator will blink, indicating that the remote will now control your cable box (see page 27 for instructions on how to program the remote to control your cable box).

To operate your set-top-box or satellite receiver select **SAT/CBL** by pressing the Source button of the Source Select on the remote. The **SAT/CBL** mode indicator will blink, indicating that the remote will now control your set-top-box or satellite receiver (see page 28 for instructions on how to program the remote to control your set-top-box or satellite receiver).

To operate your DVD player, select **DVD** by pressing the Source button of the Source Select on the remote. The **DVD** mode indicator will blink, indicating that the remote will now control your DVD Player (see page 29 for instructions on how to program the remote to control your DVD player).

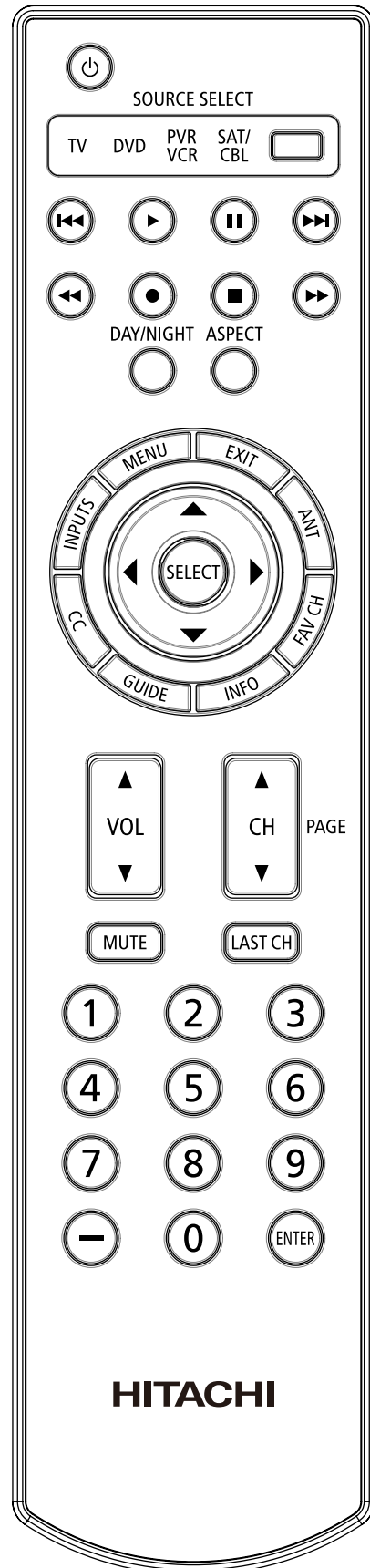

How to Use the Remote to Control Your TV

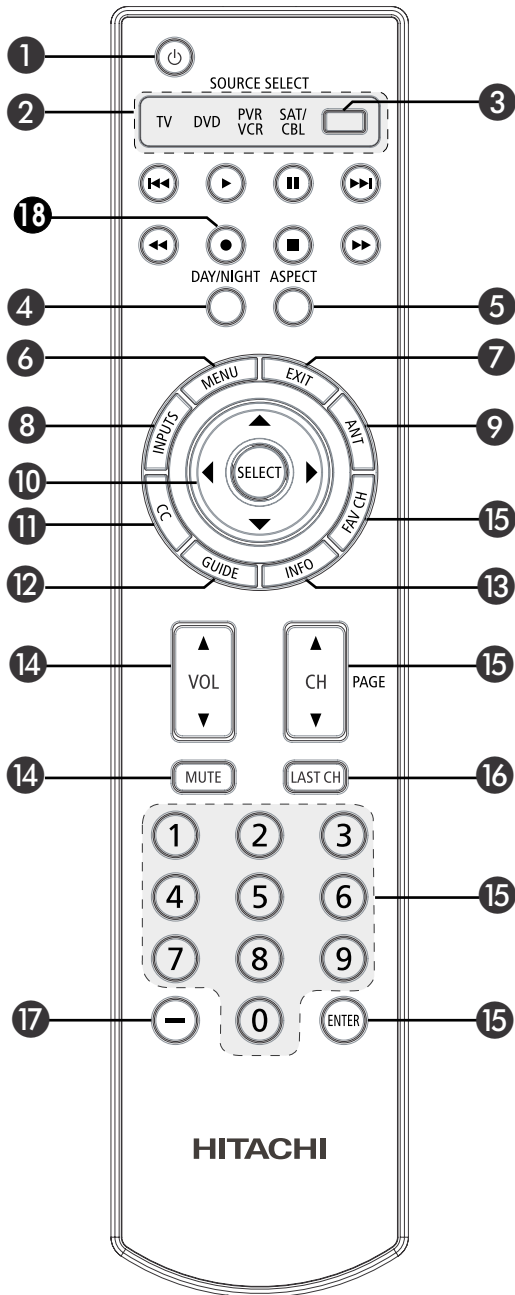

1 POWER button

Press this button to turn the TV set on or off when the remote is in TV mode. (See page 22 for instructions on how to set the remote control to TV mode).

2 MODE Indicator

Turns on or blinks three times to show remote control mode.

3 SOURCE SELECT button

Press this button to select remote control mode.

4 DAY/NIGHT button

Press this button to toggle between Day (Normal), Day (Dynamic) and Night picture mode settings. Select **DAY** for day time viewing with more brightness and contrast to compete with room light. Select **NIGHT** for night time viewing with less brightness and contrast for a more detailed picture (see page 36 for settings changes).

NOTE: For automatic **DAY/NIGHT** picture mode settings, see page 50.

How to Use the Remote to Control Your TV

5 ASPECT button

Press this button to quickly change the picture format **ASPECT** ratio. Depending on the input signal format received, the picture format ratio allows you to adjust the images through the following options.

4:3 STANDARD

Use this aspect mode to display conventional (4:3) images. Side panels (gray areas) are placed to the left and right of the image to preserve the original aspect ratio of the source.

4:3 EXPANDED

Use this aspect mode to display conventional (4:3) sources by linearly increasing image expansion from the center towards the edges of the display area in order to fill it.

4:3 ZOOM1/ZOOM2

Use these aspect modes to zoom in on conventional (4:3) sources.

16:9 STANDARD 1

Use this aspect mode to display 16:9 sources like HDTV and DVD's preserving the original 16:9 aspect ratio showing 95% of the size.

16:9 STANDARD 2

Use this aspect mode to display 16:9 sources like HDTV and DVD's preserving the original 16:9 aspect ratio showing 100% of the size.

16:9 ZOOM

Use this aspect to Zoom-in once while in 16:9 aspect.

- Antenna-Analog Channel
- S-Video/Video Input (Auto Aspect: Off)
- HDMI-480i/480p Input (Auto Aspect: Off)
- Component-480i/480p Input (Auto Aspect: Off)

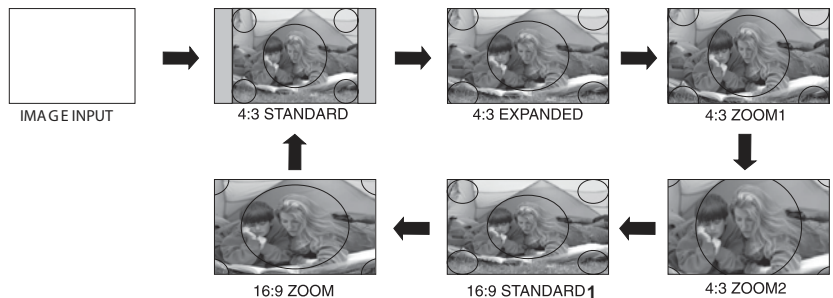

Note: Please see Appendix A on page 138-139.

- Antenna-Digital Channel (4:3)
- S-Video/Video 4:3/Letter Input (Auto Aspect: On)
- HDMI-480i/480p 4:3/Letter Input (Auto Aspect: On)
- Component-480i/480p 4:3/Letter Input (Auto Aspect: On)

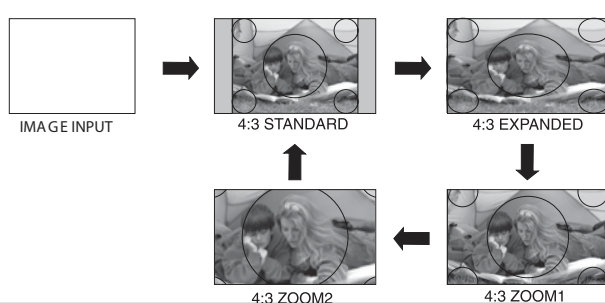

Note: Please see Appendix A on page 138-139.

- S-Video/Video 16:9 Input (Auto Aspect: On)
- HDMI-480i/480p 16:9 Input (Auto Aspect: On)
- Component-480i/480p 16:9 Input (Auto Aspect: On)

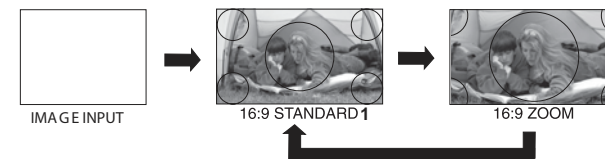

Note: Please see Appendix A on page 138-139.

- Antenna-Digital Channel (16:9)
- HDMI-720p/1080i/1080p Input
- Component-720p/1080i Input

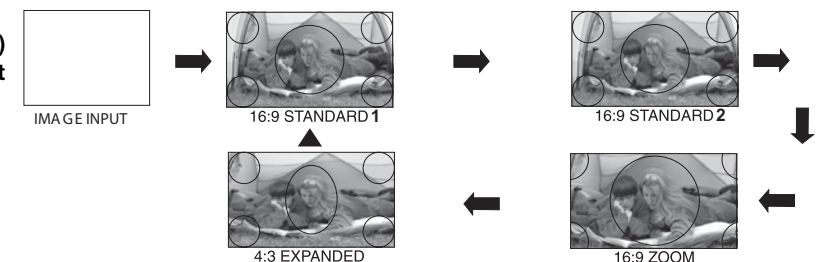

Note: Please see Appendix A on page 138-139.

- NOTE:**
1. The Aspect Style in all video inputs have independent Aspect Style setting.
 2. Vertical position adjustments are directly available when you choose 4:3 EXPANDED/ZOOM1/ZOOM2 or 16:9 ZOOM aspect style (see also page 38).
 3. When displaying 16:9 STANDARD 2 it may appear lines at the edge of the picture this is normal operation of the TV.

How to Use the Remote to Control Your TV

6 MENU button

The **MENU** button will start the On-Screen Display.

7 EXIT button

This button will exit all On-Screen Displays.

8 INPUTS button

When the remote control is in TV mode, press this button to access the **INPUTS** menu. Use the **CURSOR** and **SELECT** buttons to scroll and select the inputs that are being used. Pressing the **INPUTS** button repeatedly will also cycle through the Inputs menu items. Then press the **SELECT** button to select.

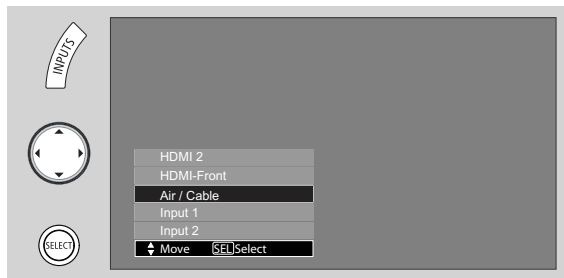

INPUT 1 Select to choose INPUT 1.

INPUT 2 Select to choose INPUT 2.

INPUT 3 Select to choose INPUT 3.

INPUT- FRONT Select to choose side INPUT .

HDMI 1 Select to choose HDMI 1 INPUT.

HDMI 2 Select to choose HDMI 2 INPUT.

HDMI- FRONT Select to choose side HDMI INPUT.

AIR/CABLE Select between Air or Cable signal.

9 ANTENNA button (ANT)

Use this button to access AIR/CABLE signal input directly.

10 CURSOR buttons/SELECT button

All the On-Screen Display features can be set or adjusted by using the **CURSOR** buttons and the **SELECT** button, except for numeric entries. Press the **CURSOR** buttons toward desired direction and press the **SELECT** button to select.

11 CLOSED CAPTIONS (CC) button

Use this button to display the dialogue, narration, and/or sound effects of a television program or home video which are displayed on the TV screen when available. Your local TV program guide denotes these programs as **CC** or **□**.

12 GUIDE button

[Cable Box (CBL), Satellite Receiver (SAT)/ Set-Top-Box (STB) mode only]

The use of this button is only applicable when the remote control is in (CBL) and (SAT/STB) mode. Press this button to access the Channel Guide of the (CBL), and (SAT/STB).

13 INFO button

Press this button when you want to check the channel being received, the picture source, if the channel has stereo (ST) or second audio program (SAP), the time, CHANNEL ID and if the **TIMER** is set.

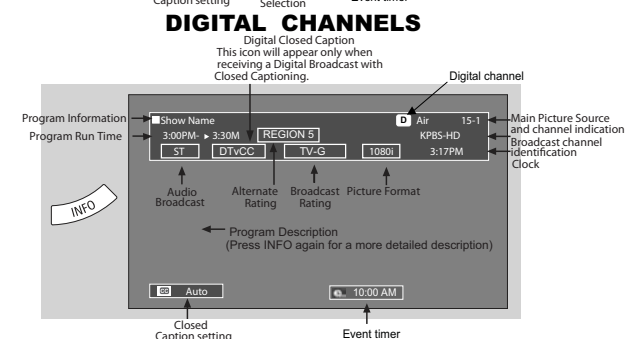
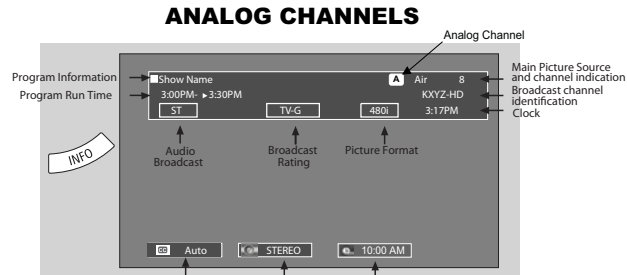

When an S-VIDEO Input is connected to INPUT 1

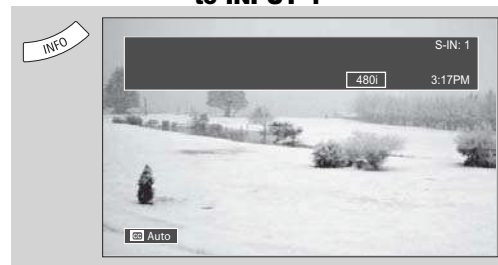

When a Component Video: Y-PbPr Input is connected to INPUT 3



- NOTE:**
1. Press the **INFO** button again or the **EXIT** button to return to normal viewing.
 2. The Aspect setting will not be shown if the channel is locked.

How to Use the Remote to Control Your TV

14 VOLUME (VOL), MUTE button

Press the **VOLUME** button (▲ or ▼) until you obtain the desired sound level.

To reduce the sound to one half of normal volume (SOFT MUTE) to answer the telephone, etc., press the **MUTE** button. Press the **MUTE** button again to turn the sound off completely (MUTE). To restore the sound, press the **MUTE** button one more time, or **VOL UP** (▲).

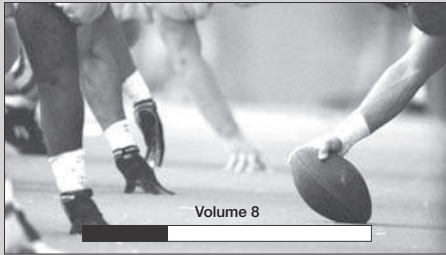

MUTE



MUTE

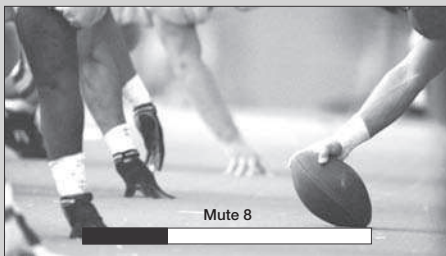

Closed Captioning will display automatically when MUTE/SOFT MUTE is on and Closed Caption is set to **AUTO** (see page 55).

When the TV power is turned off at a volume level 31 or greater, the volume level will default to 30 when the TV is turned on. However, if it is set to a level 30 or less, the volume level will be at the level it was set when the TV is turned on.

15 CHANNEL SELECTOR/FAVORITE CHANNEL (FAV CH)/ENTER buttons

The **CHANNEL SELECTOR** buttons are used to select channels, lock access code, etc. Use the **CHANNEL SELECTOR** buttons to enter one, two, or three numbers to select channels. Enter **0** first for channels **1** to **9**, or simply press the single digit channel you wish to tune then press the **ENTER** button for the TV to tune. Channel selection may also be performed by **CHANNEL (CH) UP** (▲) or **CHANNEL (CH) DOWN** (▼).

Press the **FAV CH** button to switch to Favorite (FAV) channel mode. You will know you are in Favorite Channel mode when (FAV) is displayed and the displayed channel is **GREEN**. Press it again to return to your regular tuned channels. You can add any channel to your Favorite channel list by pressing and holding down the **FAV CH** button until the displayed channel turns from **WHITE** to highlighted **GREEN**. You can also delete a channel from your favorite channel list by pressing and holding down the **FAV CH** button until the displayed channel turns highlighted **GREEN** to **WHITE**.



FAV CH



FAV CH



16 LAST CHANNEL button

Press this button to toggle between the current and last channel viewed.

17 (-) DASH button

Use the (-) **DASH** button with the **CHANNEL SELECTOR** buttons to enter Digital Channels that have subchannel numbers indicated by (-) **DASH** (example 15-1).

18 RECORD button

Press to record programs when the remote is in PVR/VCR mode.

The Remote Control for Cable Box Functions

OPERATING THE PRECODED FUNCTION FOR YOUR CABLE BOX.

This remote is designed to operate different types of cable boxes. You must first program the remote to match the remote system of your cable box (refer to pages 32-33 for pre-codes).

1. Turn ON your cable box.
2. To switch to Cable (CBL) pre-coded mode, use the **SOURCE SELECT** button on the remote control to position the LED light to the corresponding selection **SAT/CBL**.
3. Hold down the **SOURCE SELECT** button on the remote and enter the four digit preset code that matches your cable box as shown on pages 32-33. Release the **SOURCE SELECT** button. The indicator light will flash 3 times if the code was accepted.
4. Aim the remote at the cable box and press the **POWER** button. The remote will turn off your cable box when the correct four digit preset code is entered. When this occurs, the remote control is programmed for your cable box. If the cable box does not turn off, try a different four digit preset code.
5. The remote will now control your Cable box.

NOTE: 1. If your cable box cannot be operated after performing the above procedures, your cable box code has not been precoded into the remote.
 2. In the unlikely event that your cable box cannot be operated after performing the above procedures, please consult your cable box operating guide.
 3. The remote control will remember the codes you have programmed until the batteries are removed from the remote control. After replacing the batteries repeat the entire programming procedure as stated above.

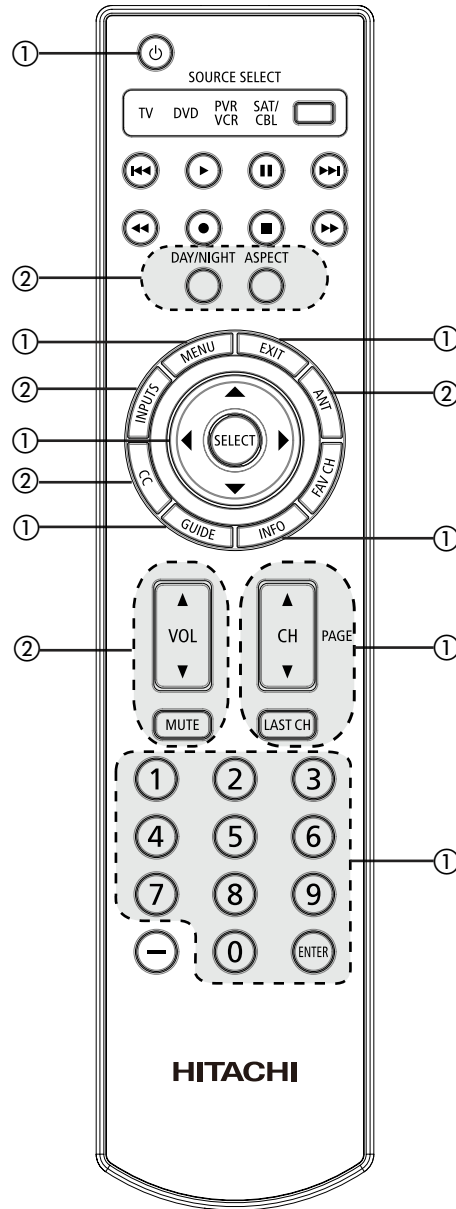

① PRECODED CABLE BOX buttons

These buttons transmit the chosen precoded cable codes :

- Power
- Cursor & Select
- Number PAD
- Menu
- Info
- Enter
- Exit
- Channel Up & Down
- Guide
- Last CH

② EXCLUSIVE TV buttons

These buttons are for operating the TV :

- Day/Night
- CC
- Inputs (only if programmed, refer to page 31)
- Aspect
- Vol Up & Down
- Mute
- ANT

MY CABLE BOX CODE IS: _____

NOTE: Refer to instruction manual of the Cable Box for operation of the buttons exclusively for the Cable Box.

The Remote Control for Set-Top-Box/Satellite Receiver Functions

OPERATING THE PRECODED FUNCTION FOR YOUR SET-TOP-BOX/SATELLITE RECEIVER.

This remote is designed to operate different types of set-top-box/satellite systems. You must first program the remote to match the remote system of your set-top-box/satellite systems (refer to pages 32-33 for pre-codes).

1. Turn ON your set-top-box/satellite systems.
2. To switch to set-top-box/satellite (SAT) pre-coded mode, use the **SOURCE SELECT** button on the remote control to position the LED light to the corresponding selection **SAT/CBL**.
3. Hold down the **SOURCE SELECT** button on the remote and enter the four digit preset code that matches your set-top-box/satellite receiver as shown on page 32-33. Release the **SOURCE SELECT** button. The indicator light will flash 3 times if the code was accepted.
4. Aim the remote at the set-top-box/satellite receiver and press the **POWER** button. The remote will turn off your set-top-box/satellite receiver when the correct four digit preset code is entered. When this occurs, the remote control is programmed for your set-top-box/satellite receiver. If the set-top-box/satellite receiver does not turn off, try a different four digit preset code.
5. The remote will now control your set-top-box/satellite receiver.

- NOTE:**
1. If your set-top-box/satellite receiver cannot be operated after performing the above procedures, your set-top-box/satellite receiver code has not been pre-coded into the remote.
 2. In the unlikely event that your set-top-box/satellite receiver cannot be operated after performing the above procedures, please consult your set-top-box/satellite receiver operating guide.
 3. The remote control will remember the codes you have programmed until the batteries are removed from the remote control. After replacing the batteries repeat the entire programming procedure as stated above.

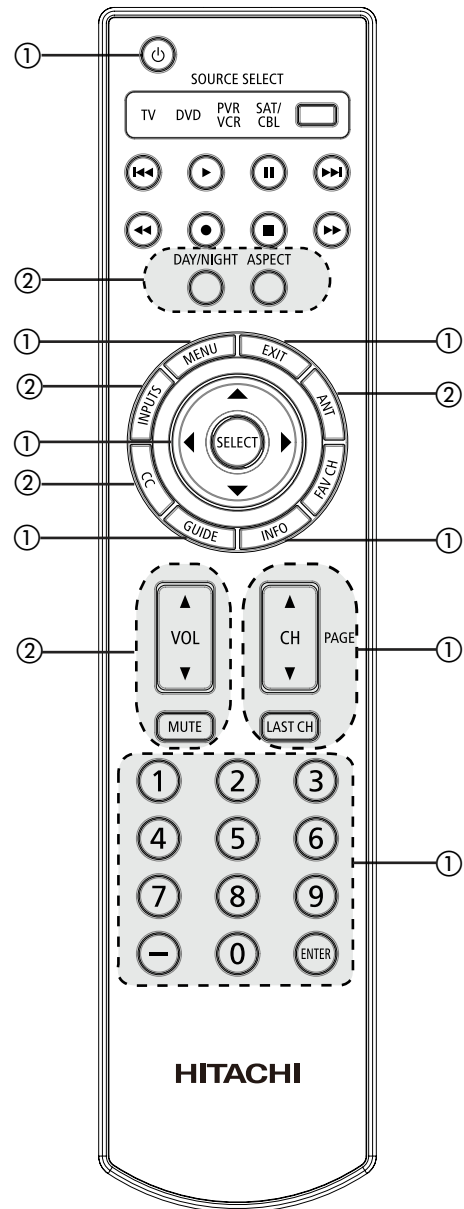

① PRECODED SET-TOP-BOX/SATELLITE RECEIVER buttons

These buttons transmit the chosen pre-coded set-top-box/satellite codes :

- Power
- Cursor & Select
- Number PAD
- Menu
- Info
- Enter, Dash
- Exit
- Channel Up & Down
- Guide
- Last CH

② EXCLUSIVE TV buttons

These buttons are for operating the TV :

- Day/Night
- CC
- Mute
- Aspect
- Vol Up & Down
- Inputs (Only if programmed, refer to page 31).
- ANT

MY Satellite RECEIVER/ SET-TOP-BOX CODE IS: _____

NOTE: Refer to instruction manual of the Set-Top-Box/Satellite Receiver for operation of the buttons exclusively for the Set-Top-Box/Satellite Receiver.

The Remote Control for DVD Functions

OPERATING THE PRECODED FUNCTION FOR YOUR DVD PLAYER.

This remote is designed to operate different types of DVD players. You must first program the remote to match the remote system of your DVD player (refer to pages 32-33 for pre-codes).

1. Turn ON your DVD player.
2. To switch to DVD pre-coded mode, use the **SOURCE SELECT** button on the remote control to position the LED light to the corresponding selection **DVD**.
3. Hold down the **SOURCE SELECT** button on the remote and enter the four digit preset code that matches your DVD player, as shown on pages 32-33. Release the **SOURCE SELECT** button. The indicator light will flash 3 times if the code was accepted.
4. Aim the remote at the DVD player and press the **POWER** button. The remote will turn off your DVD player when the correct four digit preset code is entered. When this occurs, the remote control is programmed for your DVD player. If the DVD player does not turn off, try a different four digit preset code.
5. The remote will now control your DVD player.

- NOTE:**
1. If your DVD player cannot be operated after performing the above procedures, your DVD player code has not been precoded into the remote.
 2. In the unlikely event that your DVD player cannot be operated after performing the above procedures, please consult your DVD player operating guide.
 3. The remote control will remember the codes you have programmed until the batteries are removed from the remote control. After replacing the batteries repeat the entire programming procedure as stated above.

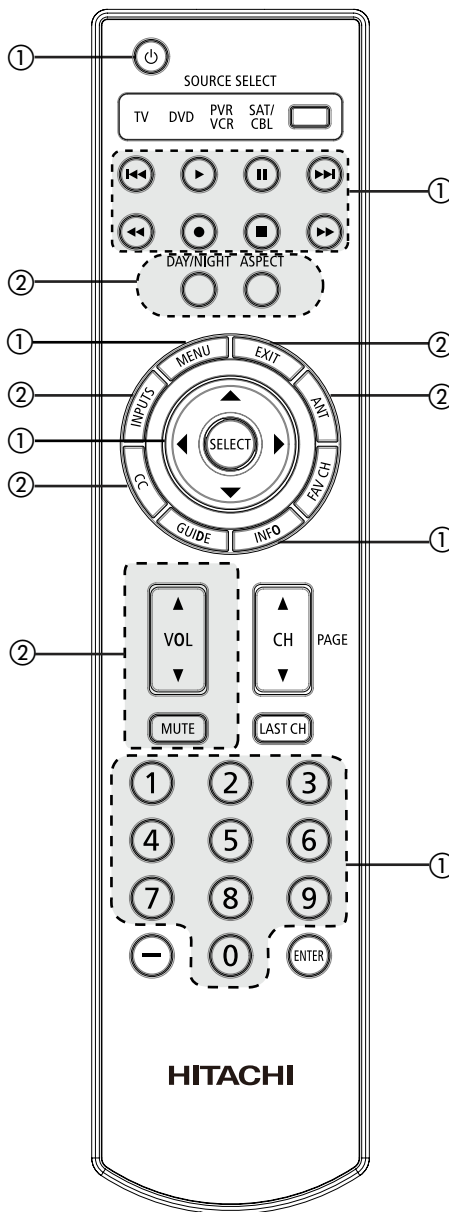

① PRECODED DVD Buttons

These buttons transmit the chosen precoded DVD codes :

- Power
- Menu
- Info
- Cursor & Select
- Number PAD
- Play, Stop, Pause,
- RWD, FWD, Skip RWD,
- Skip FWD.

② EXCLUSIVE TV Buttons

These buttons are for operating the TV :

- Day/Night
- Aspect
- ANT
- Exit
- CC
- Vol Up & Down
- Mute
- Inputs (Only if programmed, refer to page 31)

MY DVD PLAYER CODE IS: _____

NOTE: Refer to instruction manual of the DVD Player for operation of the buttons exclusively for the DVD Player.

The Remote for VCR/PVR Functions

OPERATING THE PRECODED FUNCTION FOR YOUR VCR/PVR (Personal Video Recorder).

This remote is designed to operate different types of VCRs/PVRs. You must first program the remote to match the remote system of your VCR/PVR (refer to pages 32-33 for pre-codes).

1. Turn ON your VCR/PVR.
2. To switch to VCR/PVR pre-coded mode, use the **SOURCE SELECT** button on the remote control to position the LED light to the corresponding selection **PVR/VCR**.
3. Hold down the **SOURCE SELECT** button on the remote and enter the four digit preset code that matches your VCR/PVR, as shown on pages 32-33. Release the **SOURCE SELECT** button. The indicator light will flash 3 times if the code was accepted.
4. Aim the remote at the VCR/PVR and press the **POWER** button. The remote will turn off your PVR when the correct four digit preset code is entered. When this occurs, the remote control is programmed for your VCR/PVR. If the VCR/PVR does not turn off, try a different four digit preset code.
5. The remote will now control your VCR/PVR.

- NOTE:**
1. If your VCR/PVR cannot be operated after performing the above procedures, your VCR/PVR code has not been precoded into the remote.
 2. In the unlikely event that your VCR/PVR cannot be operated after performing the above procedures, please consult your VCR/PVR operating guide.
 3. The remote control will remember the codes you have programmed until the batteries are removed from the remote control. After replacing the batteries repeat the entire programming procedure as stated above.

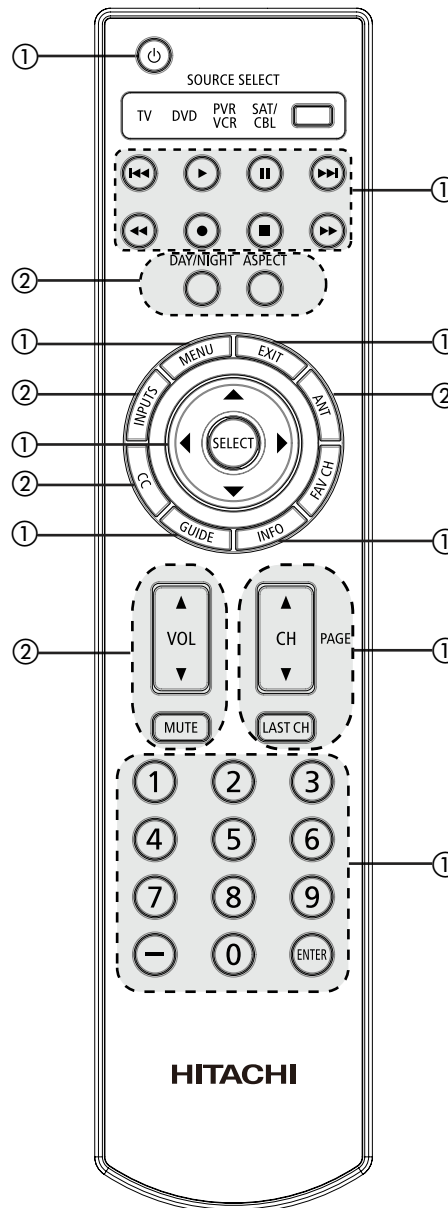

① PRECODED VCR/PVR Buttons

These buttons transmit the chosen precoded VCR/PVR codes :

- | | | |
|---------|--------------------|--------------------|
| -Power | -Cursor & Select | -Enter |
| -Menu | -Channel Up & Down | -Dash (-) |
| -Exit | -Number PAD | -Play, Pause, Stop |
| -Info | -Last CH | -FWD, Skip FWD |
| -Record | -RWD | |

② EXCLUSIVE TV Buttons

These buttons are for operating the TV :

- | | | |
|------------|----------------|--|
| -Day/Night | -CC | -Inputs (only if programmed, refer to page 31) |
| -Aspect | -Vol Up & Down | |
| -ANT | -Mute | |

MY VCR/PVR CODE IS: _____

NOTE: Refer to instruction manual of the VCR/PVR for operation of the buttons exclusively for the VCR/PVR.

How to Use the SOURCE SELECT Button

INPUT ACCESS

This optional feature allows the user of the remote control to setup its SOURCE SELECT button to access the specified input of the TV. Setup for this feature is applicable to the remote control's normal mode only and only applies to the DVD, PVR/VCR and SAT/CBL modes.

1. Select the desired device mode (DVD, PVR/VCR, SAT/CBL) by using your SOURCE SELECT button to position the LED indicator to the corresponding selection.
2. Hold down the SOURCE SELECT button on the remote and enter the four digit preset code that matches your device as shown on pages 32-33.
3. Then enter the assigned input number (1-7) that the device is related to (refer below to Table 1).
4. Release the SOURCE SELECT button.
5. If done correctly, the device LED indicator will blink 3 times to confirm proper setup.
6. The remote will now control the desired device.
7. Pressing the INPUTS button will now access the video input of the desired device.

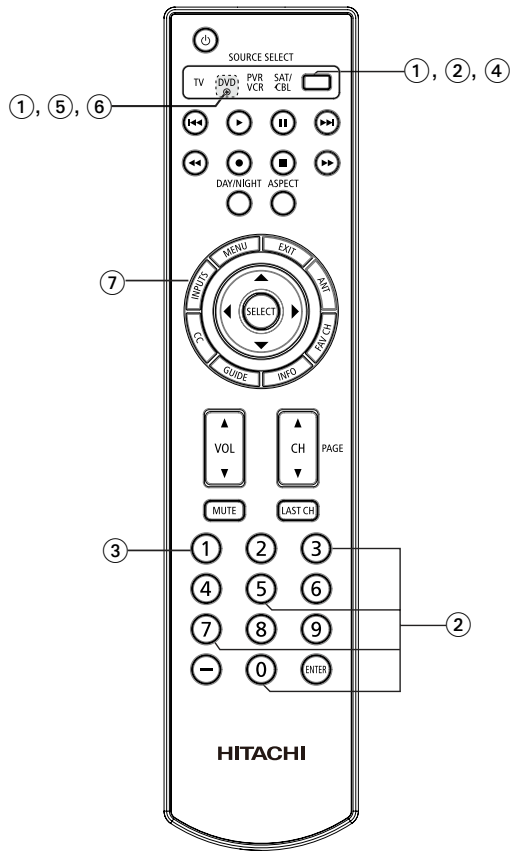

SETUP EXAMPLE (Hitachi DVD with precode 0573 connected to INPUT 1 of the TV)

- ① Select DVD mode by using your SOURCE SELECT button to position the LED indicator to DVD.
- ② Hold down the SOURCE SELECT button and press the numbers 0, 5, 7 and 3.
- ③ Then press the number 1 for the assigned input number of the DVD player.
- ④ Release SOURCE SELECT button.
- ⑤ If done correctly, the device LED indicator will blink 3 times to confirm proper setup.
- ⑥ The remote will now control the DVD player.
- ⑦ Press the INPUTS button to instantly access the video input of your DVD on Input 1.

INPUT	ASSIGNMENT NUMBER
INPUT 1	1
INPUT 2	2
INPUT 3	3
INPUT- FRONT	4
HDMI 1	5
HDMI 2	6
HDMI- FRONT	7

NOTE: 1. This feature is optional
2. Assigned input numbers can be used more than once if applicable.

Remote Control Codes

Cable BRAND Codes	General Instrument0869	Daewoo0045 0278 0020,0561	1479
ABC0003,0008,0011	GOI0775,1775	1278	Panasonic1062,0035,0162,0225,
Americast0899	Goodmans1246	Daytron0020	0616,1035,1162,1262
Amino1602	Hisense1535	Dell1972	Penney0035,0037,0240,0042,
Bell South0899	Hitachi0819,1250	Denon0042	0038,1035,1237
Clearmaster0883	HTS0775,1775	DirecTV0739	Pentax0042,0065,0105
ClearMax0883	Hughes Network System 1142,0749,1749,1442	Durabrand0039,0038	Philco0035,0479
Coolmax0883	iLo1535	Dynatech0000	Philips0035,0081,0062,0618,
Digeo1187	JVC0775,1775	Electrohome0037	0739,1081,1181
Director0476	LG1226,1414	Electroponic0037	Pilot0037
General Instrument..0476,0810,0276,0003,	Magnavox0724,0722	Emerex0032	Pioneer0067
0011	Memorex0724	Emerson0037,0184,0000,0121,	Polk Audio0081
GoldStar.....0144	Mitsubishi0749	0043,0209,0002,0278,	Portland0020
Hamlin0009,0273	Motorola0869	0061,0208,0479,0561,	Presidian1593
Hitachi0011,1421	NEC1270	0593,1278,1479,1593,	Profitronic0240
i3 Micro1602	Next Level0869	Fisher0047,0104	Proscan0060,0202,0760,0761
Jerrold0476,0810,0276,0003	Pace0887	Fuji0035,0033	1060
0012,0011	Panasonic0247,0701	Funai0000,0593,1593	Protec0072
Memorex0000	Paysat0724	Garrard0000	Pulsar0039
Motorola1376,0476,0810,0276	Philips1142,0749,1749,0724,	Gateway1972	Quarter0046
1187,1254,1106	1076,0722,0099,1442	GE0060,0035,0240,0065,	Quartz0046
Multitech0883	Proscan0392,0566	0202,0760,0761,0807,	Quasar0035,0162,1035,1162
MultiVision0012	Proton1535	1035,1060	RadioShack0000,1037
Myrio1602	RadioShack0869	Go Video0432,0526	Radix0037
Pace1877,0237,0008	RCA0566,0855,0143,1392	GoldStar0037,0038,1237	Randex0037
Panasonic0000,0107	Samsung1377,1276,1108,1109,	Gradiente0000	RCA0060,0240,0042,0149,
Paragon0000	1442,1609	Harley Davidson0000	0065,0105,0106,0202,
Philips1305,0317	Sanyo1219	Harman/Kardon0081,0038	0760,0761,0807,0880,
Pioneer1877,0877,0144,0533	SKY0856	Harwood0072	1035,1060
Pulsar.....0000	Sony0639,1639,1640	Headquarter0046	Realistic0035,0037,0048,0047,
Quasar0000	Star Choice0869	Hewlett Packard.....1972	0000,0104,0046,0062
RadioShack0883	Tivo1142,1442	Hi-Q0047	ReplayTV0614,0616
RCA1256	Toshiba0749,1749,0790,1285	Hitachi0000,0042,0041,0065,	Ricavision1972
Regal0279,0273	UltimateTV1392,1640	0089,0105,0543,0544	Runco0039
Rembrandt0011	Uniden0724,0722	Howard Computers1972	Samsung0240,0045,0739,1014
Runco0000	US Digital1535	HP1972	Sanky0048,0039
Samsung0144	USDTV1535	Hughes Network System.0042,0739	Sansui0000,0067,0209,0041,
Scientific Atlanta1877,0877,0477,0008	Voom0869	Humax0739	0271,0479,1479
Sejin1602	Zenith0856,1856	Hush1972	Sanyo0047,0240,0104,0046,
Signature.....0011	DBS/PVR Codes	iBUYPOWER1972	0159
Sony1006	Combo BRAND	Jensen0041	Scott0184,0045,0121,0043
Starcom0003	DirecTV1377,0392,0639,1142,	JVC0067,0041,0008	Sears0035,0037,0047,0000,
Supercable0276	1076,0099,1392,1442,	KEC0037,0278	0042,0104,0046,0105,
Supermax0883	1640	Kenwood0067,0041,0038	1237
Thomson1256	Dish Network System1505,0775	KLH0072	Sharp0048,0062,0807,0848
Tocom0012	Dishpro1505,0775	Kodak0035,0037	Shintom0072
Torx0003	Echostar1505,0775	LG1037	Shogun0240
Toshiba0000	Expressvu0775	Linksys1972	Singer0072
Tristar0883	Hughes Network System.1142,1442	Lloyd's0000,0208	Sonic Blue0614,0616
V20883	Motorola0869	Logik0072	Sony0035,0032,0033,0000,
Viewmaster0883	Philips1142,1442	LXI0037	0636,1032,1232,1972
Vision0883	Proscan0392	Magnasonic0593,1278	Stack0009,1972
Vortex View0883	RCA1392	Magnavox0035,0039,0081,0000,	STS0042
Zenith0000,0525,0899	Samsung1442	0149,0563,0593,1593,	Sylvania0035,0081,0000,0043,
Cable/PVR Codes	Sony0639,1640	1781	0593,1593,1781
Combo BRAND	Star Choice0869	Magnin0240	Symphonic0000,0593,1593
Americast0899	VCR BRAND Codes	Marantz0035,0081	Systemax1972
Digeo1187	ABS1972	Marta0037	Tagar Systems1972
General Instrument ..0810	Admiral0048,0209	Matsushita0035,0162,1162	Tatung0041
Jerrold0810	Adventura0000	Media Center PC1972	Teac0000,0041
Motorola1376,0810,1187,1106	Aiko0278	MEI0035	Technics0035,0162
Pace1877,0237	Aiwa0037,0000,0124,0307	Memorex0035,0162,0037,0048,	Teknika0035,0037,0000
Pioneer1877,0877	Akai0041,0061,0106,0175	0039,0047,0240,0000,	Thomas0000
RCA1256	Alienware1972	0104,0209,0046,0307,	Tivo0618,0636,0739,1996
Scientific Atlanta1877,0877	America Action0278	0479,1037,1162,1237	TMK0240,0208
Sony1006	American High0035	1262	Toshiba0045,0043,0845,1008,
Supercable0276	Asha0240	MGA0240,0043,0061	1145,1972,1996
Thomson1256	Audiovox0037,0278	MGN Technology0240	Totevision0037,0240
Zenith0899	Beaumarck0240	Microsoft1972	Touch1972
SATELLITE BRAND Codes	Bell & Howell0104	Mind1972	Unitech0240
(Set Top Box)	Broksonic0184,0121,0209,0002	Minolta0042,0105	Vector0045
AlphaStar0772	0479,1479	Mitsubishi0067,0043,0061,0807	Vector Research0038
Chaparral0216	Calix0037	Motorola0035,0048	Video Concepts0045,0061
Crossdigital1109	Canon0035	MTC0240,0000	Videomagic0037
DirecTV1377,0392,0566,0639,	Capehart0020	Multitech0000,0072	Videosonic0240
1639,1142,0247,0749,	Carver0081	NEC0104,0067,0041,0038	Viewsonic1972
1749,0724,0819,1856,	CCE0072,0278	Nikko0037	Villain0000
1076,1108,0099,1109,	Citizen0037,0278,1278	Niveus Media1972	Voodoo1972
1414,1442,1609,1392,	Coft0072	Noblex0240	Wards0060,0035,0048,0047,
1640	Craig0037,0047,0240,0072	Northgate1972	0081,0240,0000,0042,
Dish Network System 1505,1005,0775,1775	0271	Olympus0035	0072,0149,0062,0760
Dishpro 1505,1005,0775,1775	Curtis Mathes0060,0035,0162,0041	Onkyo0222	White Westinghouse0209,0072
Echostar 1505,1005,0775,1775	0760,1035	Optimus1062,0162,0037,0048,	XR-10000035,0000,0072
Expressvu 0775,1775	Cyberbex0240	0104,0432,0593,1048,	Yamaha0038
GE 0566	CyberPower1972	1162,1262	Zenith0039,0033,0000,0209,
		Optonica0062	0479,1139,1479
		Orion0184,0209,0002,0479	ZT Group1972

Remote Control Codes

DBS/PVR Combo BRAND	Codes	Enterprise	0591	Sony	0533,1533,0864,1033,1431
Hughes Network Systems	0739	ESA	0821,1268	Sova	1122
Philips	0739	Fisher	0670,1919	Sungale	1074
Samsung	0739	Funai	0675,1268,1334	Superscan	0821
		Gateway	1073,1077,1158	SVA	0860,1105
		GE	0522,0815,0717	Sylvania	0675,0821,1268
PVR BRAND	Codes	Go Video	0744,0715,0741,0783,0833,0869,1044,1075,1099,1144,1158,1304,1730	Symphonic	0675,0821
ABS	1972			Teac	0758,0790,0809
Alienware	1972			Technics	0490,0703
CyberPower	1972			Technosonic	0730
Dell	1972	Go Vision	1071,1072	Techwood	0692
DirectTV	0739	GoldStar	0741	Terapin	1031
Gateway	1972	GPX	0699,0769	Theta Digital	0571
Hewlett Packard	1972	Greenhill	0717	Toshiba	0503,0695,1045,1154
Howard Computers	1972	Harman/Kardon	0582,0702	Tredex	0799,0800,0803,0804
HP	1972	Hitachi	0573,0664,1247,1919	TYT	0705
Hughes Network Systems	0739	Hiteker	0672	Urban Concepts	0503
Humax	0739	iLo	1348	US Logic	0839
Hush	1972	Initial	0717	Venturer	0790
iBUYPOWER	1972	Insignia	1268	Vizio	1064,1226
Linksys	1972	Integra	0627	Xbox	0522
Media Center PC	1972	JBL	0702	Yamaha	0490,0539,0545
Microsoft	1972	Jensen	1016	Zenith	0503,0591,0741,0869
Mind	1972	JSI	1423	Zoece	1265
Niveus Media	1972	JVC	0558,0623,0867,1164		
Northgate	1972	jWin	1049,1051		
Panasonic	0616	Kawasaki	0790	DVD-R Codes	
Philips	0618,0739	Kenwood	0490,0534,0682,0737	Accurian	1416
RCA	0880	KLH	0717,0790,1020,1149	Apex Digital	1056
ReplayTV	0614,0616		1261	Aspire Digital	1168
Samsung	0739	Konka	0711,0719,0720,0721	Coby	1086
Sonic Blue	0614,0616	Koss	0651,0896,1423	CyberHome	1129
Sony	0636,1972	Landel	0826	Funai	0675,1334
Stack	0009,1972	Lasonic	0798,1173	Gateway	1073,1158
Systemax	1972	Lenoxx	1127	Go Video	0741,1158,1304,1730
Tagar Systems	1972	LG	0591,0741,0801,0869	iLo	1348
Tivo	0618,0636,0739	LiteOn	1058,1158,1416,1440	JVC	1164
Toshiba	1008,1972,1996	Loewe	0511	LG	0741
Touch	1972	Magnavox	0503,0539,0646,0675,0821,1268	LiteOn	1158,1416,1440
Viewsonic	1972	Malata	0782,1159	Magnavox	0646,0675
Voodoo	1972	Marantz	0539	Panasonic	0490
ZT Group	1972	Memorex	0695,0831,1270	Philips	0646
		Microsoft	0522	Pioneer	0631
		Mintek	0839,0717	Polaroid	1086
DVD BRAND	Codes	Mitsubishi	1521,0521	RCA	0522
Accurian	1072,1416	Momitsu	1082	Samsung	0490
Advent	1016	NAD	0741	Sensory Science	1158
Aiwa	0641	NEC	0785	Sharp	0675
Akai	0695,0770,0899,1089	Nesa	0717	Sony	1033,1431
Alco	0790	Next Base	0826	Sylvania	0675
Allegro	0869	NexxTech	1402	Zenith	0741
Amphion Media Works	0872	Norcent	1003,0872,1107,1265		
AMW	0872	Onkyo	0503,0627,0792		
Apex Digital	0672,0717,0755,0794,0795,0796,0797,0830,1004,1020,1056,1061,1100	OptoMedia Electronics	0896		
Arrgo	1023	Oritron	0651		
Aspire Digital	1168,1407	Panasonic	0490,0632,0703,1362,1462,1490,1762		
Audiologic	0736,	Philco	0690,0733,0790,0862,1855,2000		
Audiovox	0790,1041,1071,1072,1121,1122	Philips	0503,0539,0646,0675,0854,1260,1267,1354		
Axion	1071,1072	Pioneer	0525,0571,0631,0632		
B & K	0655,0662	Polaroid	1020,1061,1086		
Blaupunkt	0717	Polk Audio	0539		
Blue Parade	0571	Portland	0770		
Broksonic	0695,0868	Presidian	0675,1072		
Cambridge Soundworks	0690	Prima	1016		
Cinea	0831	Proscan	0522		
CineVision	0876,0833,0869	ProVision	0778		
Citizen	1277	Qwestar	0651		
Coby	0778,0852,1086,1107,1165,1177,1351	RCA	0522,0571,0717,0790,0822,1022,1132,1193		
Craig	0831	Rio	0869		
Curtis Mathes	1087	Rotel	0623		
CyberHome	0816,0874,1023,1024,1117,1129,	Rowa	0823		
Daewoo	0784,0705,0833,0869,1169,1172,1234,1242	Sampo	0698,0752		
Denon	0490,0634	Samsung	0490,0573,0820,0899,1044,1075		
Desay	1407	Sansui	0695		
Disney	0675,1270	Sanyo	0670,0695,0873,1919		
Dual	1068,1085	Sensory Science	1158		
Durabrand	1127	Sharp	0630,0675,0752,1256		
DVD2000	0521	Sharper Image	1117		
Emerson	0591,0675,0821,1268	Sherwood	0633,0770,1043,1077		
		Shinsonic	0533,0839		
		Sonic Blue	0869,1099		

On-Screen Display

1. Press **MENU** on the remote control to display the different features on your **HITACHI LCD TV**.
2. Use the **CURSOR PAD** (buttons **▲**, **▼**, **◀** and **▶**) and highlight a different feature of the On-Screen Display menu. Press the **SELECT** button to select.
3. Press **EXIT** on the remote control to quickly exit from a menu.

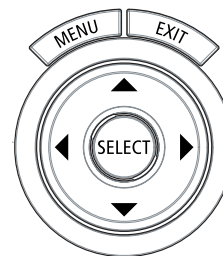

This part of the screen shows which selections are available.

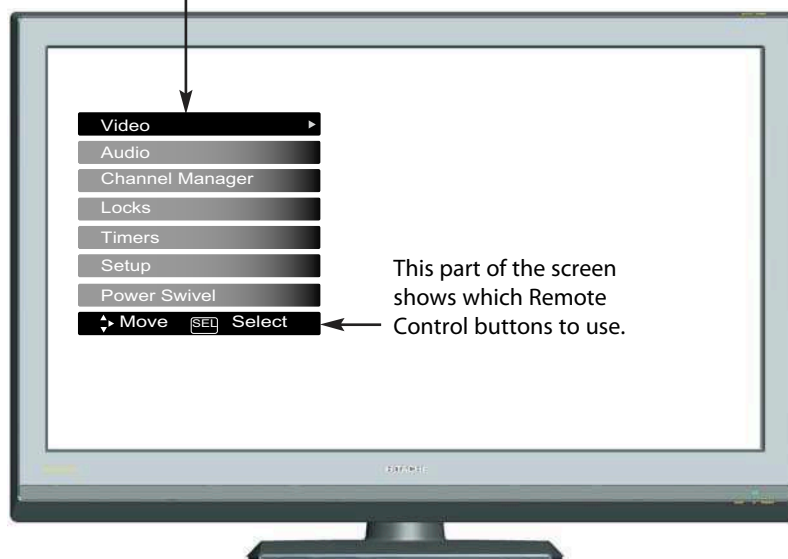

NOTE: The On Screen Display (OSD) for the different submenus shown in next pages are for illustration purposes only, therefore; doesn't reflect the actual appearance of the OSD of your **HITACHI LCD TV**.

Video ▼

Picture Mode	Select between 3 picture modes; Day Dynamic, Day Normal and Night.
Contrast	Adjust contrast.
Brightness	Adjust brightness.
Color	Adjust color.
Tint	Adjust tint.
Sharpness	Adjust sharpness.
Back Light	Adjust back light.
ColorTemperature	Set this to High for less intense color with more blue, set to Medium for natural color, set to Standard for standard colors or Black and White for more reddish color.
Black Enhancement	Enhance picture brightness in light scenes.
Contrast Mode	Use this function to choose between two Contrast Mode settings.
Noise Reduction	Reduces conspicuous noise in the picture.

MPEG NR	Reduces mosquito noise in the picture.
Auto Movie Mode	Turn On/Off the 3:2 Pulldown detection feature.
Auto Color	The AUTO COLOR function automatically monitors and adjusts the color to maintain constant color levels even after a program or channel changes. It also maintains natural flesh tones while preserving fidelity of background colors.
Black Side Panel	Set the gray side bars On/Off when watching 4:3 signals in standard mode.
Aspect	Choose the picture format aspect ratio.
Reset Video Settings	Choose to Reset Video Settings to factory settings.

On-Screen Display

Audio

Treble	Adjust the treble.
Bass	Adjust the bass.
Balance	Adjust the balance.
Surround	Select Surround settings (Off, Wide, Normal)
Bass Boost	Select Bass Boost option ON or OFF.
Audio Source	Select between three Audio Sources.
Internal Speakers	Select internal or external speakers.
Auto Noise Cancel	Eliminates the noise between stations.
Perfect Volume	Adjust volume in fixed setting between stations.
Loudness	Adjust Loudness.
Language	Select Language options if available.
Digital Output	Select Optical Output options.
DRC	Select Dynamic Range Compression to ON or OFF.
Lip Sync	Synchronizes audio with video signal on digital and analog sources.

NOTE: The Language, Digital Output, and the Dynamic Range Compression feature of the Audio OSD are only available for Digital channels.

Channel Manager

Signal Meter	Access Signal Meter.
Auto Channel Scan	Set Auto Channel Scan.
Channel List	Set Channel List.

Locks

Change Access Code	Change Lock access code.
Engage Lock	Choose to lock channel, and/or Front panel.
Movie Ratings	Block various types of movies and video types based on motion picture ratings.
TV Ratings	Block various types of movies and television programming based on a parental guide ratings.
Canadian Ratings (ENG)	Block various types of movies and television programming based on the Canadian ratings system.
Canadian Ratings (FRN)	Block various types of movies and television programming based on the Canadian French ratings system.
Region 5	Ratings system for DTV Signal to block various types of programs.

Timers

Set the Clock	Set Clock Settings.
Set Sleep Timer	Set Sleep Timer intervals (30 min. intervals, 00:30-3:00).
Set Day/Night Timer	Set Day/Night picture mode settings.
Set Event Timer	Set viewing reservation for TV programs.

Setup

Set The Menu Options	Choose English, French, or Spanish text and Background.
Set The Power Saving	Automatic Power saving features.
Set The Inputs	Label Video Inputs, VCR, DVD, etc.
Set The Closed Captions	Feature to display dialogue/text.
Select The Quick Start Option	Select the TV Quick Start Up Option.
Reset The Software	Select to upgrade TV software and to Reset TV settings.

Power Swivel

Unlocked	Power Swivel enabled. Control the motorized Table Top Stand
Locked	Power Swivel disabled.

NOTE: 1. The Signal Meter feature of the Channel Manager OSD is only available for Digital channels.
2. Power Swivel feature is only available when Table Top Stand is connected.

Video

Video

Select **VIDEO** to adjust picture settings and improve picture quality. You can independently customize each of the Video Inputs to your preference to increase viewing performance and pleasure depending upon the video program being viewed. If **RESET** is selected, only the selected input will reset to initial conditions.

Picture Mode

Use this function to choose from automatic picture settings to optimize your TV's performance.

1. Use the **CURSOR** buttons ◀ or ▶ to highlight and select **PICTURE MODE** settings (Day-Normal, Day-Dynamic or Night).
2. Then press the **SELECT** button to set the mode and return to the Video menu or press **EXIT** to quit menu.
3. There are 3 Picture Modes available for the customer Day (Dynamic) , Day (Normal) and Night mode. Day (Dynamic) is the original factory preset mode , this can be changed by adjusting any video setting to your desire conditions. Day (Normal) can be used as a second video setting for daytime viewing. Night is set to watch programing during nighthime.

1. Use the **CURSOR PAD** ▲ or ▼ to highlight the function to be adjusted.
2. Press the **SELECT** button or the **CURSOR PAD** ▶ to select the function settings.
3. Press the **CURSOR PAD** ◀ or ▶ to adjust the function.
4. Press **MENU** to return to main menu.
5. Press **EXIT** to quit menu.

Contrast

Use this function to change the contrast between black and white levels in the picture.

Brightness

Use this function to adjust overall picture brightness.

Color

Use this function to adjust the level of color in the picture.

Tint

Use this function to adjust flesh tones so they appear natural.

Sharpness

Use this function to adjust the amount of fine detail in the picture.

Back Light

Use this function to change the back light of the LCD panel, this will increase or decrease the brightness of the LCD panel but not the brightness of the video signal.

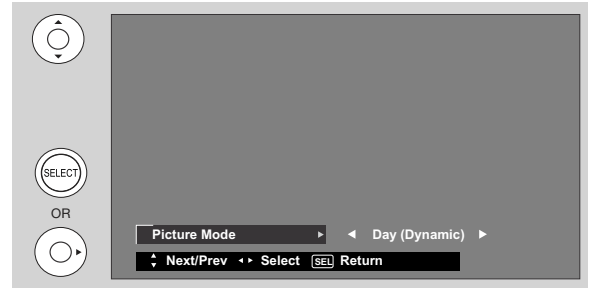
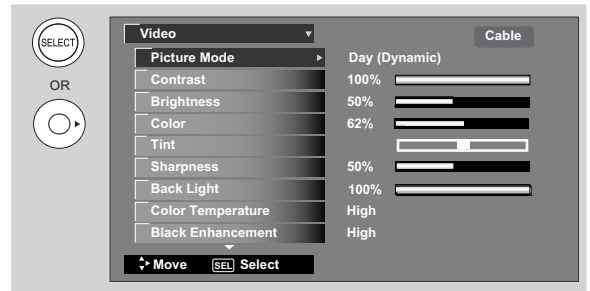

Video

Color Temperature

Set this to High for cooler color with more blue, set to Medium for more natural color, set to Standard for accurate color or set to Black/White for more reddish color.

Black Enhancement

Use this function to enhance the shadow detail in dark scenes using the settings off, low, middle and high.

- NOTE:**
1. If **CONTRAST** is selected, you are adjusting **CONTRAST**. The additional menu items **BRIGHTNESS**, **COLOR**, **TINT**, and **SHARPNESS** can be selected and adjusted in the same manner.
 2. It may be necessary to adjust **TINT** to obtain optimum picture quality when using the **COMPONENT VIDEO Y-PbPr** input jacks.
 3. **CABLE** and **AIR** share a Video setting. Also, each of the video inputs have their own independent settings.

Contrast Mode

Use this function to choose between 2 Contrast Mode settings. Set to **DYNAMIC** for darker images more in the level of Black, set to **NORMAL** for a balanced White to Black level.

Noise Reduction

The **NOISE REDUCTION** function automatically reduces conspicuous noise in the picture without degrading picture quality. Set **NOISE REDUCTION** to **OFF** if the TV experiences picture blocking.

MPEG NR

The **MPEG NR** (Noise Reduction) function automatically reduces mosquito noise in the picture without degrading picture quality. Set **MPEG NR** to **OFF** if the TV experiences picture block noise.

Auto Movie Mode

The **AUTO MOVIE MODE** function turn ON or OFF the 3:2 PULLDOWN DETECTION SPECIAL FEATURE. Theatrical movies are shot on film at 24 frames or still pictures per second, instead of 30 frames or 60 fields like video. When film is transferred to video for television viewing, the disparity between the two frame rates must be reconciled. This involves a process known as 3:2 pulldown.

When **AUTO MOVIE MODE** is turned ON from the **VIDEO** menu, your Hitachi LCD Television will activate the circuitry for this special feature to improve video performance when watching film based sources.

Auto Color

The **AUTO COLOR** function automatically monitors and adjusts the color to maintain constant color levels even after a program or channel changes. It also maintains natural flesh tones while preserving fidelity of background colors.

NOTE: When receiving Antenna Digital Channel, using Component or HDMI input, Auto Color will not be available (grayed out).

Black Side Panel

The **BLACK SIDE PANEL** function turns the gray side bars from gray to black when watching 4:3 signals in Standard mode.

1. Press the **CURSOR PAD** ◀ or ▶ to set to ON or OFF.
2. Press **EXIT** to quit menu or select **SET BLACK SIDE PANEL** to return to the previous menu.

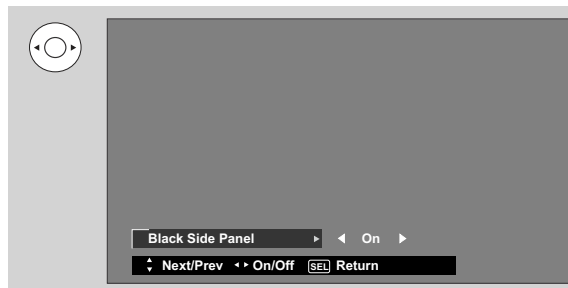
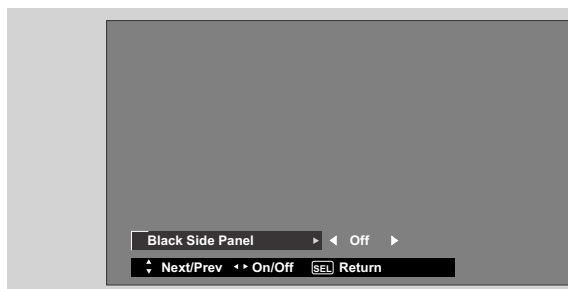

NOTE: This setting return to Off automatically after TV power On/Off.

Video

Aspect

Use this function to select the Picture Format Aspect Ratio.

Auto Aspect

Automatically adjust the Aspect Ratio depending on the input signal to fill the screen.

Mode

Manually select the Aspect Ratio.

Vertical Position

This function allows you to change the vertical position when aspect style is either 4:3 EXPANDED/ZOOM1/ZOOM2 or 16:9 ZOOM. For example, it will be useful for centering the picture area at both the top and bottom of the picture with 480i/480p signal.

Adjustable range is -10 (video center is toward bottom of screen) to +10 (video is toward top of screen).

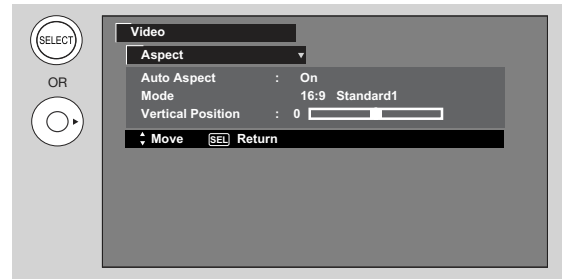

1. Use the **CURSOR PAD ▲** or **▼** to select menu item.
2. Press the **CURSOR PAD ◀** or **▶** to adjust the function.
3. Press the **EXIT** to quit the **MENU**, or select **ASPECT** to return to the main menu.

NOTE: 1. Vertical Position will not be available in 4:3 Standard and 16:9 Standard modes.
2. Vertical Position setting returns to "0" automatically after TV power On/Off.

Reset Video Settings

This function allows you to Reset the Video Menu Settings of the present input and return it to the Day-Dynamic VIDEO mode.

1. Use **CURSOR PAD ▲,▼** to highlight functions.
2. Press the **SELECT** button or **CURSOR PAD ▶** to select Reset Video Settings.
3. Use the **CURSOR PAD ▼** to access at the Reset softkey.
4. Press the **SELECT** button to Reset the Video Settings.

You can customize each of the Video Inputs to your preference to increase viewing performance and pleasure, depending upon the video program being viewed. If **RESET** is selected, only the selected Input will reset to the initial conditions as explained above.

If **RESET** is selected in Input 1, only Input 1 will return to factory conditions.

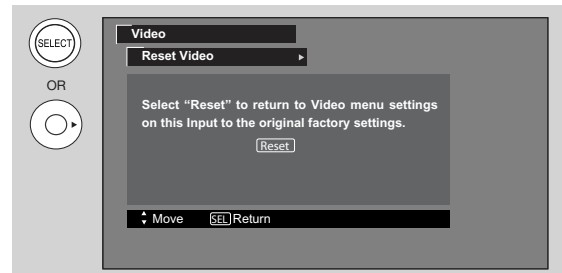
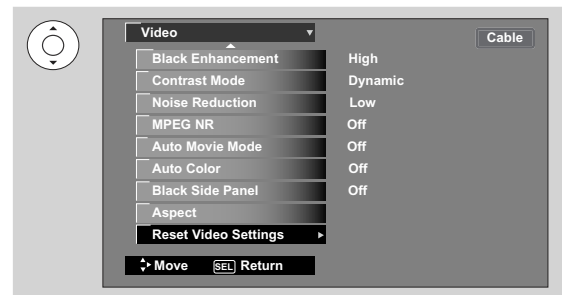

Audio

Audio

Select **AUDIO** to adjust the TV to your preference and to improve the sound quality.

1. Press **CURSOR PAD ▲** or **▼** to select menu item.
2. Press **CURSOR PAD ◀** or **▶** to adjust the function.
3. Press **EXIT** to quit the **MENU**, or select **AUDIO** to return to the main menu.

NOTE: If **TREBLE** is selected you are adjusting treble. The additional menu items **BASS** and **BALANCE** can be selected and adjusted in the same manner.

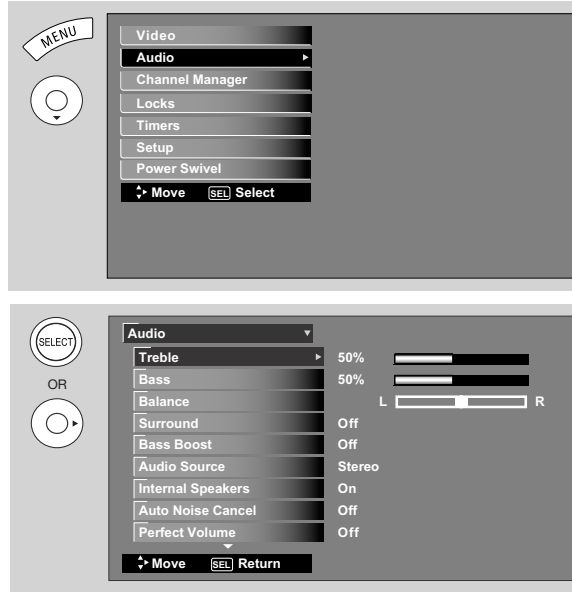

Treble

This function controls the high frequency audio to all speakers.

Bass

This function controls the low frequency audio to all speakers.

Balance

This function will control the left to right balance of the LCD TV internal speakers.

Surround

Surround sound is the concept of expanding the spatial imaging of audio from one dimension (Mono/Left-Right) to two or three dimensions. This is often done to create a more realistic audio environment.

- 1.- Use **CURSOR PAD ▲** or **▼** to highlight surround option.
- 2.- Use **CURSOR PAD ◀** or **▶** to select Off, Normal or Wide.

Off : turns off the surround sound effect.

Normal Surround : Provides the surround effect by locating two or more speakers to the rear of the listener.

Wide Surround : Reproduce much better quality 5 channel sound signals from ordinary stereo contents comparing with normal surround technology. Wide surround enable users to enjoy sound playback in wide surround virtual area like 5 channel contents with ordinary stereo contents.

Bass Boost

This function allows to enhance the low frequency audio performance of your speaker system.

Audio

Audio Source

Multi-Channel Television Sound will allow you to select **STEREO** (a stereo broadcast), **MONO** (monaural sound) used when receiving a weak stereo broadcast or **SECOND AUDIO PROG** (SAP) which may be a secondary language, weather report, etc.

Internal Speakers

This function is useful when setting up the external speakers.

ON	Select this feature if using the internal speakers only.
TV as Center	Select this feature when setting up external speakers from a separate stereo system. The TV's speakers will work as the center speaker.
OFF	Select this feature if you prefer to use only speakers from a separate stereo system.

Auto Noise Cancel

This function eliminates the noise between stations. If a channel is tuned and is noisy, this function will automatically eliminate the audio for that channel.

Perfect Volume

This function will automatically adjust volume so each channel and input has the same average volume level.

Loudness

Set this function to ON to emphasize bass and treble at low volume levels.

Language

Some programs transmit more than one DTV language option. Most will have English as a default language. The language function will allow you to select up to 4 language options (if available).

Digital Output

This function allows you to select between Dolby® Digital and PCM. This setting will be fed into optical output.



Dolby® Digital - Select this feature if the TV is connected to an amplifier/receiver with a Dolby® Digital only decoder; it will provide six independent soundtrack channels through the optical output jack (Digital Audio).

NOTE: *Manufactured under license from Dolby Laboratories. "Dolby" and the double-D symbol are trademarks of Dolby Laboratories.

PCM - Select this feature if the TV is connected to an amplifier/receiver with a PCM only decoder; it will provide two independent soundtrack channels through the optical output jack (Digital Audio).

DRC

Dynamic Range Compression - Use this function to compress the range of sound volume. By compressing the range of sound volume, it is possible not only to suppress the output of loud sound at night but also to raise the volume of low sound. The default setting is ON.

Use the **CURSOR PAD** ◀ or ▶ to select the chosen options.

NOTE: The functions Language, Digital Output and DRC are only available when viewing digital programs.

Use the functions at right if your TV is connected to an amplifier/receiver with optical digital input with Dolby® Digital or PCM decoder capabilities.

NOTE: 1.- The DRC control affects only Dolby® Digital signals decoded internally by the TV.
2.- DRC does not affect the Dolby Digital bitstream available at the digital audio output.

Lip Sync

Selecting this feature will allow you to synchronize the audio with the picture signal on a digital or analog source. Use the **CURSOR PAD** ◀ or ▶ to synchronize the picture and the audio signal. The default value is set to 0.

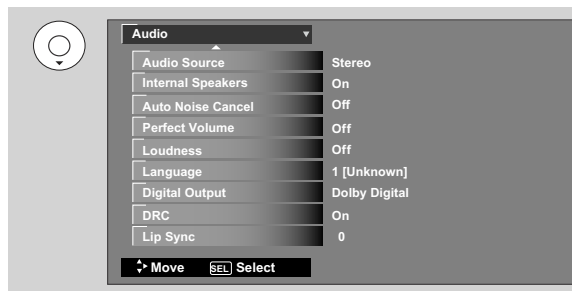
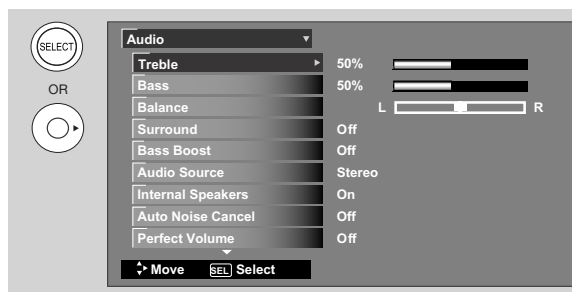

Channel Manager

Channel Manager

Select **CHANNEL MANAGER** to set your Antenna options, run Auto Channel Scan, Check Signal Meter and Set Channel List.

1. Press **CURSOR PAD ▲,▼** to highlight functions.
2. Press the **SELECT** button or **CURSOR PAD ►** to select.

Signal Meter

Select **SIGNAL METER** when using an indoor or outdoor antenna. This feature will show the signal strength and peak values of the Antenna signal to help you adjust your antenna to optimize signal reception.

Use the **CURSOR PADS** and the **SELECT** button to highlight and select **CLOSE** to exit.

NOTE: The Signal Meter will not be available (grayed out) when watching analog channels.

Auto Channel Scan

This feature will automatically store active Analog and Digital channels in Auto Channel Scan memory.

1. Use the **CURSOR** buttons **◀** or **▶** to highlight **AIR**, **CABLE (1)** or **CABLE(2)** source.
2. Press the **CURSOR** buttons **◀** or **▶** to highlight the **START** or **RESET** option.
3. Press the **SELECT** button to select.

NOTE: 1. If certain channels are poor or not possible in cable(1) mode, set cable source to cable(2) by using the **CURSOR** buttons **◀** or **▶**.

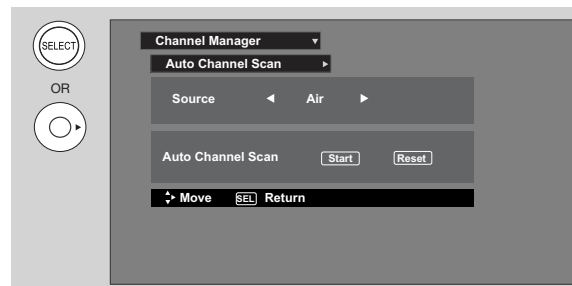
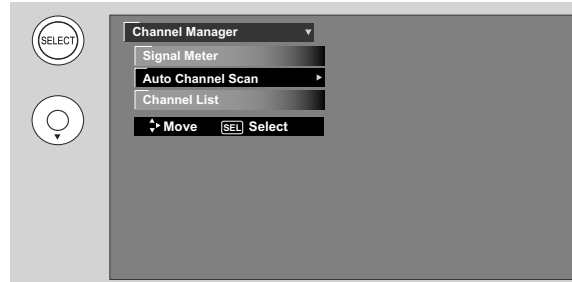
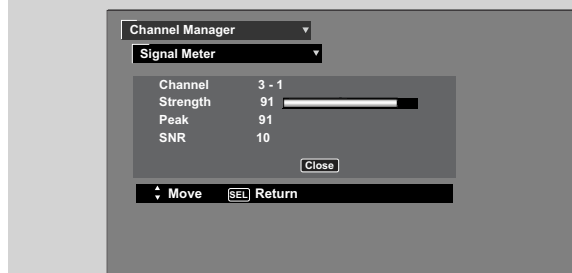

Channel Manager

Channel List

This function allows you to review which channels are labeled (**ID**), which have been added to **CHANNEL MEMORY (SCAN)**, which are protected by **LOCK** and which are your **FAVORITE (FAV) CHANNELS**.

1. Use the **CURSOR PAD** to navigate the Channel List.
2. Press the **SELECT** button to select **ON** or **OFF** on the **SCAN** and **LOCK** columns.
3. To select **LOCK** column, input the access code. (Default access code: 0000)
4. Press the **FAV** button to set or remove the **FAVORITE** settings.
5. Press the **EXIT** button to return to normal viewing.

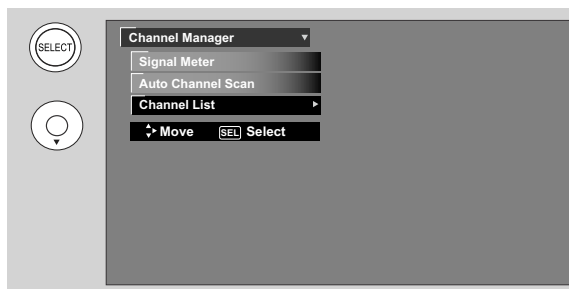

NOTE: 1. The Channel List cannot be updated by only changing the cable source. Auto Channel Scan must be performed for the Channel List to be updated.

Notice: United States federal law requires broadcasters to stop transmitting analog (non-digital) television signals after February 17, 2009.

Accordingly, this TV's analog tuner will not be capable of receiving over-the-air analog television broadcasts after such analog broadcasts are no longer available.

After February 17, 2009, this TV's analog tuner will continue to work with compatible cable and satellite TV systems, gaming consoles, VCRs, DVD players and other similar products.

Both before and after February 17, 2009, this TV's digital tuner will receive available over-the-air digital television broadcasts using an antenna and other digital television broadcasts using compatible cable, satellite or other digital television system connections.

Please review this Owner's Guide for further information regarding such connections.

Locks

Locks

This function will block out the picture and sound of the selected channel or video input.

The code to enter the Locks feature is a four digit access code number. The factory preset code is **0000**. Use the **NUMBER** buttons to enter the access code.



1. Use the **CURSOR PAD** ▲, ▼ to highlight the desired function in the **LOCKS** menu.
2. Press the **SELECT** button to select.

Change Access Code

1. To change the **ACCESS CODE NUMBER**, select **CHANGE ACCESS CODE** to change the factory preset code (**0000**) to your preference.

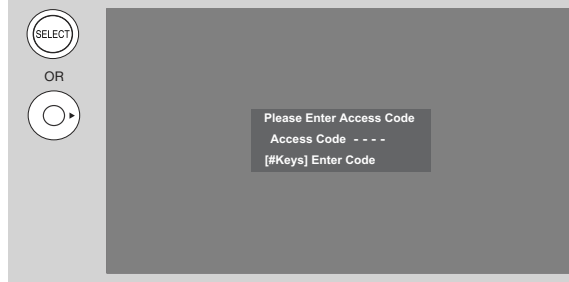

If you forget your **ACCESS CODE NUMBER**, use the factory code **7777** to erase your key number. This will reset the access code number back to the factory preset (**0000**).

2. Enter a new four digit number.
3. Press **EXIT** to quit the menu.

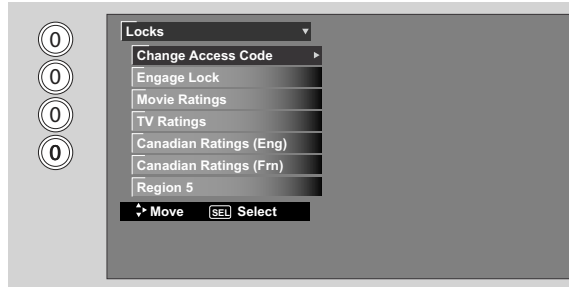

Engage Lock

When **ENGAGE LOCK** is selected, **SET CHANNEL LOCK** and **SET FRONT PANEL LOCK** can be set individually.

When **SET CHANNEL LOCK** is turned on, the picture and sound for the chosen channel will be blocked out.

When **FRONT PANEL LOCK** is turned on, all buttons on the Front Panel will be deactivated, except the **POWER** button.

When **MOVIE RATINGS** is selected, you can block various types of movies and video tapes based on motion picture ratings (see page 44).

When **TV RATINGS** is selected, various types of television programming based on a parental guide ratings will be blocked (see page 45).

Use **CANADIAN RATINGS** to block various types of movies and television programs based on the two rating systems used in Canada that you feel may be inappropriate due to its content (see pages 46-47).

Use **REGION 5** to block various types of movies and television programs based on ratings systems used in U.S. that you feel may be inappropriate due to its content (see page 48).

NOTE:

The **REGION 5** option will operate for Digital Channels only.

Locks

Movie Ratings

Use Movie Ratings to prevent viewing of any movie that you feel may be inappropriate due to its content.

1. Use the **CURSOR PAD** ▲, ▼ to select the **MOVIE RATING** category that you want to block.
2. Press **SELECT** to block the **MOVIE RATING** that you have selected. Once rating is selected, for example PG-13, all movies rated PG-13 and higher (R, NC-17, and X) will be blocked.
3. Press **EXIT** to quit the menu or select **MOVIE RATING** to return to the previous menu.

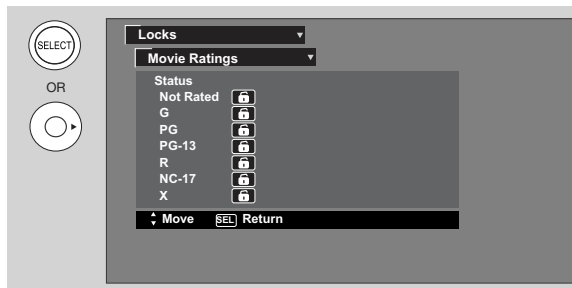
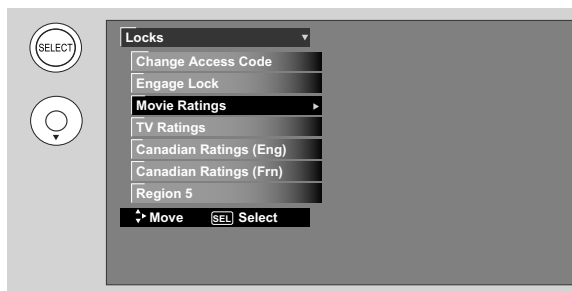

Motion Picture Ratings Table

NOT RATED	Contains no rating. Not Rated (NR) and Not Applicable (NA) programs. Movie has not been rated or ratings do not apply.
G	General audiences. All ages admitted.
PG	Parental guidance suggested. Some material may not be suitable for children.
PG-13	Parents strongly cautioned. Some material may be inappropriate for children under 13.
R	Restricted. Under 17 requires accompanying parent or adult guardian.
NC-17	No one 17 and under admitted.
X	Adults only

NOTE: 1. A movie rating is dependent upon the movie that is viewed. If the movie does not carry a rating, the TV will not block it.
 2. Blocking **NOT RATED** programs may block emergency programming, sports, news, public service announcements, religious programs and weather.

Locks

TV Ratings

Use **TV RATINGS** to prevent the viewing of any TV program that you feel may be inappropriate due to its content.

1. Use the **CURSOR PAD** ▲, ▼ to select the **TV RATING** category that you want to block.
2. Press **SELECT** to block the **TV RATING** that you have selected.
3. Press **EXIT** to quit the menu or select **TV RATING** to return to the previous menu.

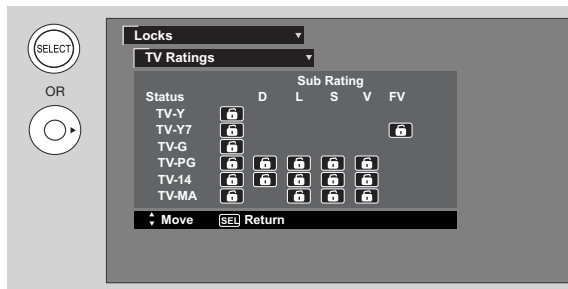
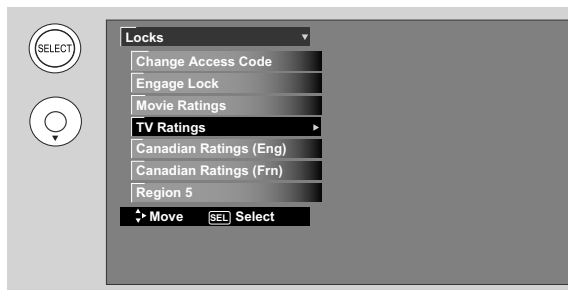

TV Parental Guide Ratings Table

TV-Y	All children. The themes and elements in this program are specifically designed for a very young audience, including children from ages 2-6.
TV-Y7	Directed to older children. Themes and elements in this program may include mild physical or comedic violence, or may frighten children under the age of 7.
TV-G	General audience. It contains little or no violence, no strong language, and little or no sexual dialogue or situations.
TV-PG	Parental guidance suggested. The program may contain infrequent coarse language, limited violence, some suggestive sexual dialogue and situations.
TV-14	Parents strongly cautioned. This program may contain sophisticated themes, intense sexual situation, more intense violence and intensely suggestive dialogue.
TV-MA	Mature audiences only. This program may contain mature themes, indecent language, graphic violence, and explicit sexual content.
FV	Fantasy Violence
V	Violence
S	Sexual Situation
L	Adult Language
D	Sexually Suggestive Dialogue

- NOTE:** 1. If you Block **TV-14D**, you will still permit **TV-MA** programs; If you block **TV-14V**, you will automatically block **TV-MAV** programs, but you will still permit **TV-MALS** programs. This means that the TV will block violence in **TV-14** and higher (**TV-MA**), but not language and sex.
2. TV program ratings are dependent on the broadcaster. If the program is not rated, the TV will not block it.

Locks

Canadian Ratings (Eng)

Use **CANADIAN RATINGS (ENG)** to block any type of movie and television program in Canada that you feel might be inappropriate in its content.

1. Use the **CURSOR PAD ▲, ▼** to select the **CANADIAN RATINGS (ENG)** category that you want to block.
2. Press **SELECT** to block the **CANADIAN RATINGS (ENG)** that you have selected. Once rating is selected, for example **C8+**, all movies and television programs rated **C8+** and higher (**G,PG, 14+** and **18+**) will be blocked automatically.
3. Press **EXIT** to quit the menu or select **CANADIAN RATINGS (ENG)** to return to the previous menu.

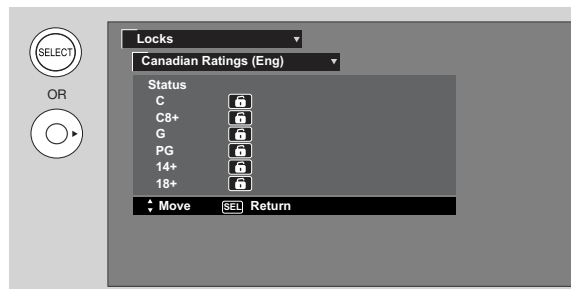
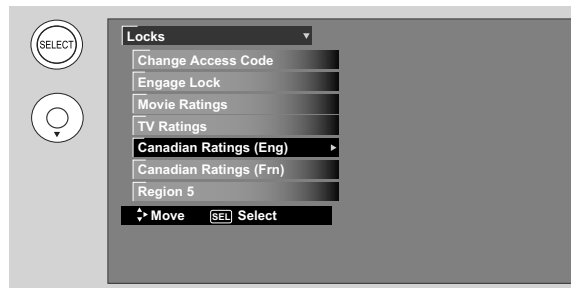

Canadian Ratings English Table

C	Programming intended for children under age 8 - Violence Guidelines; Careful attention is paid to themes, which could threaten children's sense of security and well-being. There will be no realistic scenes of violence. Depictions of aggressive behaviour will be infrequent and limited to portrayals that are clearly imaginary, comedic or unrealistic in nature. Other Content Guidelines: There will be no offensive language, nudity or sexual content.
C8+	Programming generally considered acceptable for children 8 years and over to watch on their own - Violence Guidelines: Violence will not be portrayed as the preferred, acceptable, or only way to resolve conflict; or encourage children to imitate dangerous acts which they may see on television. Any realistic depictions of violence will be infrequent, discreet, of low intensity and will show the consequences of the acts. Other Content Guidelines: There will be no profanity, nudity or sexual content.
G	General Audience - Violence Guidelines: Will contain very little violence, either physical or verbal or emotional. Will be sensitive to themes which could frighten a younger child, will not depict realistic scenes of violence which minimize or gloss over the effects of violent acts. Other Content Guidelines: There may be some inoffensive slang, no profanity and no nudity.
PG	Parental Guidance - Programming intended for a general audience but which may not be suitable for younger children. Parents may consider some content inappropriate for unsupervised viewing by children ages 8-13. Violence Guidelines: Depictions of conflict and/or aggression will be limited and moderate; may include physical, fantasy, or supernatural violence. Other Content Guidelines: May contain infrequent mild profanity, or mildly suggestive language. Could also contain brief scenes of nudity.
14+	Programming contains themes or content which may not be suitable for viewers under the age of 14 - Parents are strongly cautioned to exercise discretion in permitting viewing by pre-teens and early teens. Violence Guidelines: May contain intense scenes of violence. Could deal with mature themes and societal issues in a realistic fashion. Other Content Guidelines: May contain scenes of nudity and/or sexual activity. There could be frequent use of profanity.
18+	Adult - Violence Guidelines: May contain violence integral to the development of the plot, character or theme, intended for adult audiences. Other Content Guidelines: May contain graphic language and explicit portrayals of nudity and/or sex.

Locks

Canadian Ratings (Frn)

Use **CANADIAN RATINGS (FRN)** to block Canadian French programs according to various program ratings that you feel might be inappropriate in its content.

1. Use the **CURSOR PAD ▲, ▼** to select the **CANADIAN RATINGS (FRN)** category that you want to block.
2. Press **SELECT** to block the **CANADIAN RATINGS (FRN)** that you have selected. Once rating is selected, for example **8 ANS+**, all movies and television programs rated **8 ANS+** and higher will be blocked automatically.
3. Press **EXIT** to quit the menu or select **CANADIAN RATINGS (FRN)** to return to the previous menu.

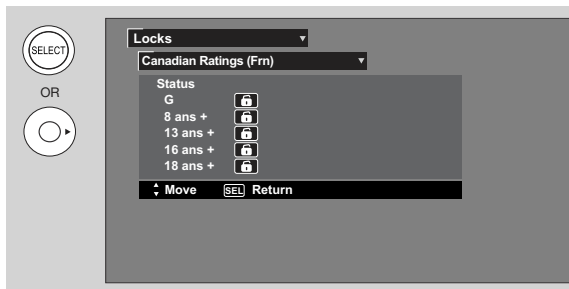
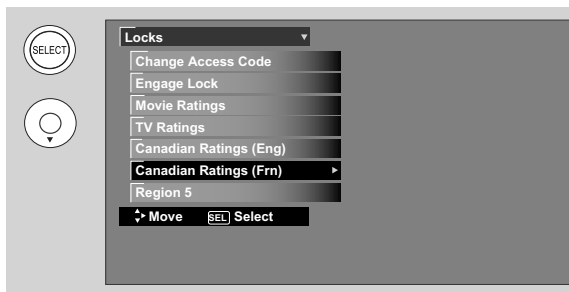

Canadian Ratings French Chart

G	General - Programming intended for audiences of all ages. Contains no violence, or the violence content is minimal or is depicted appropriately with humor or caricature or in an unrealistic manner.
8 ans +	8 + General - Not recommended for young children - Programming intended for a broad audience but contains light or occasional violence that could disturb young children. Viewing with an adult is therefore recommended for young children (under the age of 8) who cannot differentiate between real and imaginary portrayals.
13 ans +	Programming may not be suitable for children under the age of 13 - Contains either a few violent scenes or one or more sufficiently violent scenes to affect them. Viewing with an adult is therefore strongly recommended for children under 13.
16 ans +	Programming is not suitable for children under the age of 16 - Contains frequent scenes of violence or intense violence.
18 ans +	Programming restricted to adults - Contains constant violence or scenes of extreme violence.

Locks

Region 5

Use **Region 5** Ratings to prevent viewing of any movie or program that you feel may be inappropriate due to its content. This feature will operate only for ATSC Digital signal.

In order to set the **Region 5** Ratings the ATSC Digital channel received must include **Region 5** Ratings data. To see if the channel has **Region 5** Ratings, press the **INFO** key on the R/C. See fig. (1) for reference. Once the TV has received **Region 5** Ratings data, the **Region 5** option in the lock menu will display the data.

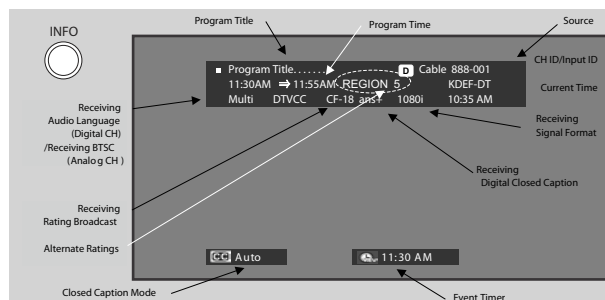
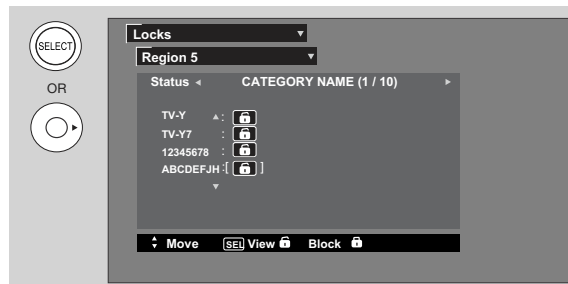
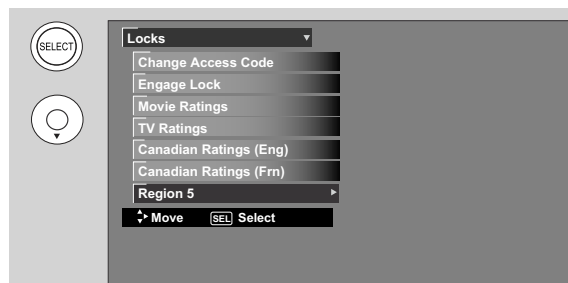

Fig. (1)

1. Use the **CURSOR** buttons ▼ or ▲ to select the **REGION 5** category that you want to block.
2. Press **SELECT** to block the **REGION 5** that you have selected. Once rating is selected, for example **PG-13**, all movies rated **PG-13** and higher (**R, NC-17 and X**) will be blocked.
3. Press **EXIT** to quit the menu or select **REGION 5** to return to the previous menu.



Alternate Ratings (Example Only) :

G	General audiences. All ages admitted.
PG	Parental guidance suggested. Some material may not be suitable for children.
PG-13	Parents strongly cautioned. Some material may be inappropriate for children under 13.
R	Restricted. Under 17 requires accompanying parent or adult guardian.
NC-17	No one 17 and under admitted.
X	Adults only
Y	Adults only

Timers

Timers

Select **TIMERS** to set your Clock, Sleep Timer, Event Timer and Day/Night Timer.

1. Use the **CURSOR** buttons ▲ or ▼ to highlight the function to be adjusted.
2. Press the **SELECT** button to select.



Set The Clock

The Clock must be adjusted before you can use the **SET EVENT TIMER** or **DAY/NIGHT TIMER** feature.

1. Use the **CURSOR PAD** ◀, ▶, ▲, ▼ to highlight the chosen **TIME ZONE** settings.
2. Press the **SELECT** button to select. If you observe daylight savings, use **CURSOR PAD** to highlight **DAYLIGHT SAVING CORRECTION** and press the **SELECT** button to select.
3. Use the **CURSOR PAD** ◀, ▶, ▲, ▼ to highlight the **CURRENT TIME** (hour and minute), **AM** or **PM**, **MONTH**, **DAY**, and **YEAR**.
4. Use the **CURSOR PAD** ▲, ▼ to adjust settings.
5. Press the **SELECT** button to set the **TIME AND DATE**.
6. Press **EXIT** to quit the menu or select **SET THE CLOCK** to return to the previous menu.

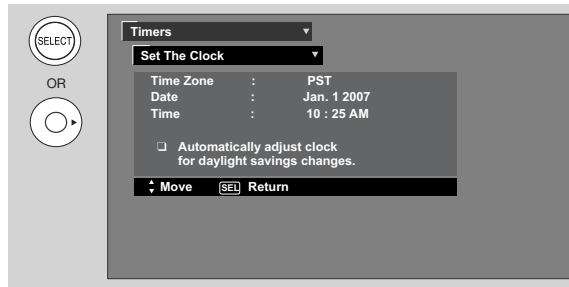
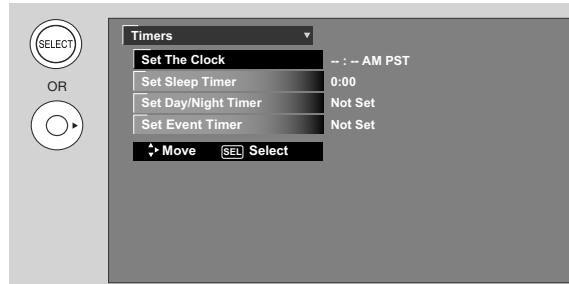

- NOTE:**
1. When **AUTOMATICALLY ADJUST CLOCK FOR DAYLIGHT SAVING CHANGES** is checked ✓, the TV will automatically calculate the clock adjustment for Daylight Saving.
 2. The TV counts electrical pulses for regulating the **TIMERS**. When the power cord is unplugged then plugged quickly the clock is stopped momentarily and the **TIME** indication will become slow.

Timers

Set Sleep Timer

Select this feature to set your **SLEEP TIMER** from 30 minutes to 3 hours (30 minute increments).

1. Press the **CURSOR PAD** ► repeatedly to set your Timer from **0:00, 0:30, 1:00, 1:30, 2:00, 2:30** and **3:00**.

NOTE: The Sleep Timer info will show for 1 minute before the TV turns off.

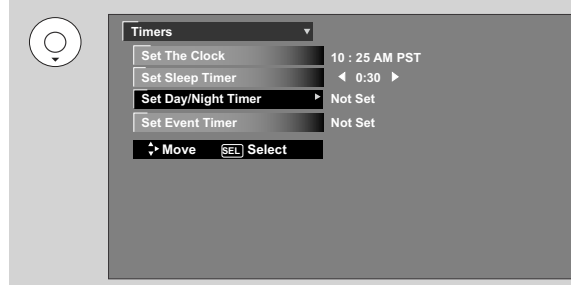
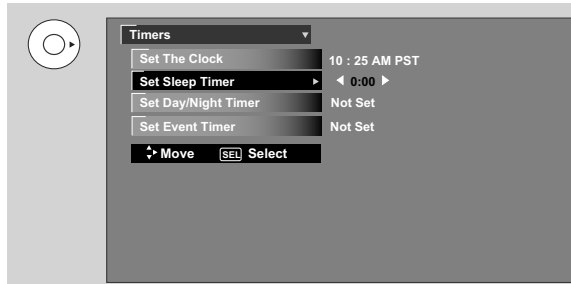
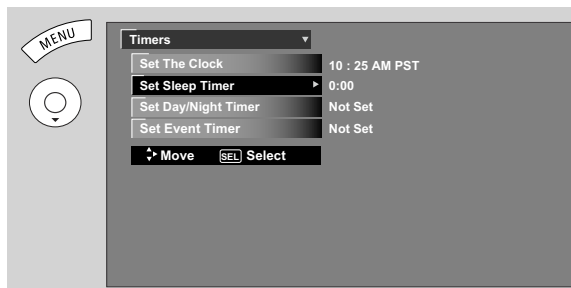

Set Day/Night Timer

Select this feature to activate and set your TV's **DAY/NIGHT PICTURE MODE** automatically. This feature is not available until the clock is set.

1. Use the **CURSOR PADS** to highlight **SET DAY/NIGHT TIMER** settings.
2. Press the **SELECT** button to select the option.
3. Use the **CURSOR PADS** to select **DAY NORMAL MODE ON** and to set its **TIMER**.
4. Use the **CURSOR PADS** to select **DAY DYNAMIC MODE ON** and to set its **TIMER**.
5. Use the **CURSOR PADS** to select **NIGHT MODE ON** and to set its **TIMER**.
6. Press **EXIT** to quit the menu or select **SET DAY/NIGHT TIMER** to return to the previous menu.

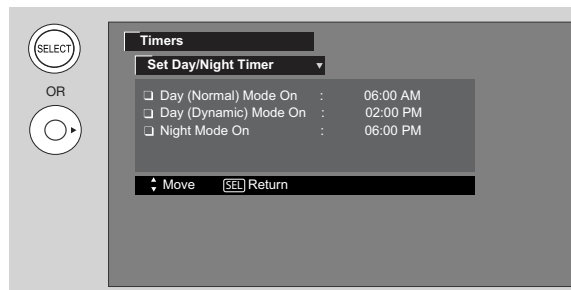

Timers

Set Event Timer

This function will automatically operate the LCD TV viewing reservation of a program. If the clock is not set, you can not use this function and the screen at right will appear. The message on the screen will disappear after 3 seconds, then the screen automatically goes to the clock setup mode (see page 49).

1. Use the **CURSOR PAD ▲, ▼** to highlight **EVENT 1, EVENT 2, EVENT 3, EVENT 4** and then press the **SELECT** button to select.
2. Use the **CURSOR PAD ►, ▲** or **▼** to highlight and select **START TIME HOUR/MINUTE**.
3. Use the **CURSOR PAD ►, ▲** or **▼** to highlight and select **START TIME AM/PM**.
4. Use the **CURSOR PAD ►, ▲** or **▼** to highlight and select **FINISH TIME HOUR/MINUTE**.
5. Use the **CURSOR PAD ►, ▲** or **▼** to highlight and select **FINISH TIME AM/PM**.
6. Use the **CURSOR PAD ►** to highlight the **MONTH**.
7. Use the **CURSOR PAD ▲** to select a **MONTH** or **CURSOR PAD ▼** to select **DAILY, WEEKLY - SUNDAY TO MONDAY**. Use the **CURSOR PAD ◀** to return to **MONTH**.
8. Use the **CURSOR PAD ►, ▲** or **▼** to highlight and select the **DAY** of the **MONTH**.
9. Use the **CURSOR PAD ►, ▲** or **▼** to highlight and select the **YEAR**.
10. Use the **CURSOR PAD ►,▲** or **▼** or **NUMBER** buttons to set the channel the TV will tune into.
11. A in the box means the Event is enabled.

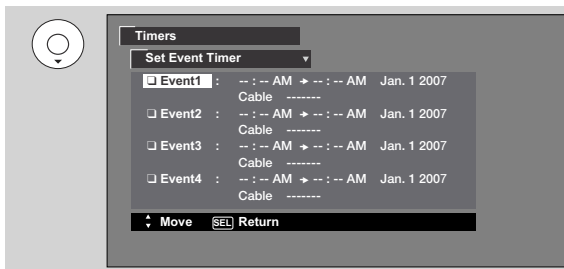
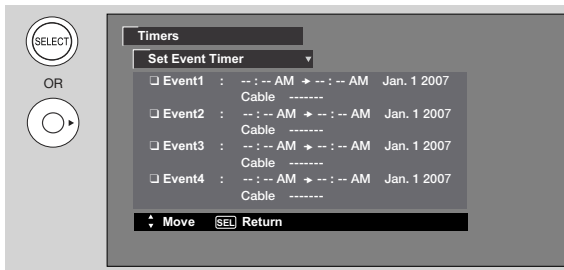
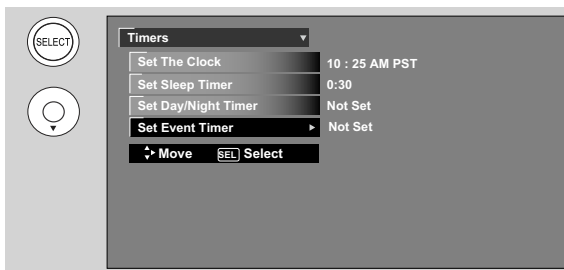

NOTE: 1. When the **INFO** button is pressed, the Event Timer Icon will only display the current date **ON/OFF** timer.
 2. The **OFF TIMER** will only activate if the TV was turned on by the **ON TIMER**, and any menu operations (includes channel selection) were not made after this time. If you change the channel or operate the menu after the **ON TIMER** has been activated, the **OFF TIMER** will deactivate.



CAUTION: Do not use your TV as a deterrent when away from home by using the **ON** and **OFF TIMERS**. For safety, the TV should be turned off when you are away from home.

Setup

Setup

Select **SETUP** when setting your TV up for the first time.

1. Use the **CURSOR PAD** ▲ or ▼ to select the sub-menu of your choice.
2. Press the **SELECT** button to select.

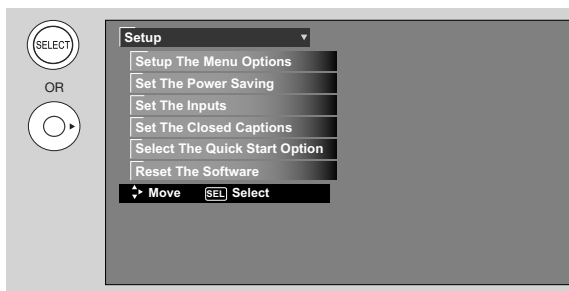

Set The Menu Options

Setup the Language and background of the Menu OSD.

Set The Language

This feature will allow you to select any one of three different languages for all on-screen displays.

1. Use the **CURSOR PAD** ◀ or ▶ to select the language of your choice.
2. Press **EXIT** to quit menu or select **SET THE MENU OPTIONS** to return to previous menu.

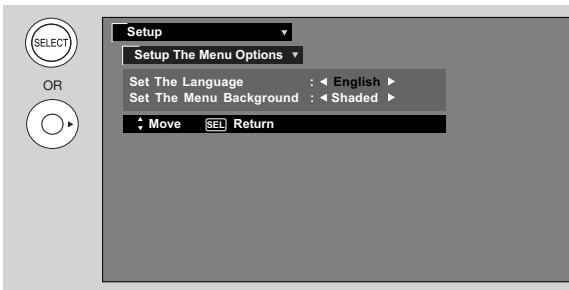
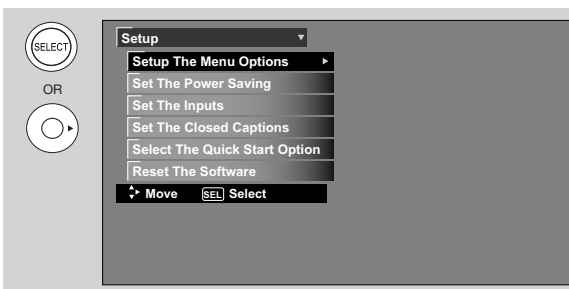

Setup

Set The Menu Background

This function allows you to choose from two menu backgrounds.

1. Use **CURSOR PAD** ▲ or ▼ to highlight **SET THE MENU BACKGROUND** option. Use the **CURSOR PAD** ◀ or ▶ to select shaded or solid.
2. Select **SOLID** for a black background (no picture can be seen behind menu screen), select **SHADED** and a light background is visible.
3. Press **EXIT** to quit menu or select **SET THE MENU OPTIONS** to return to the previous menu.

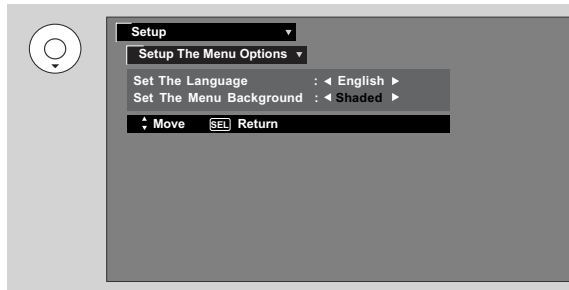

Set The Power Saving

This feature helps to increase the lamp life.

Image Power

Use this feature to have the save energy by changing back light level in three modes: Max, Med and Min.

1. Press the **CURSOR** buttons ◀ or ▶ to select the modes Max, Med or Min.

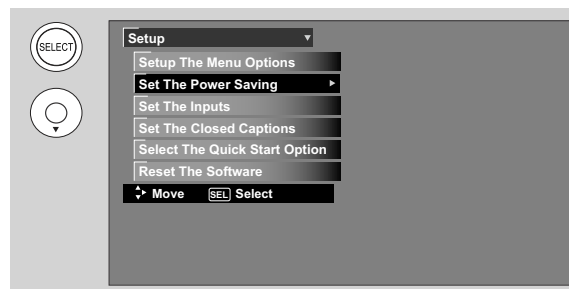

Automatic Power Saving

Use this feature to have the TV turned OFF automatically when a video signal is not detected for about 12 seconds.

1. Press the **CURSOR** buttons ◀ or ▶ to highlight Yes or No.

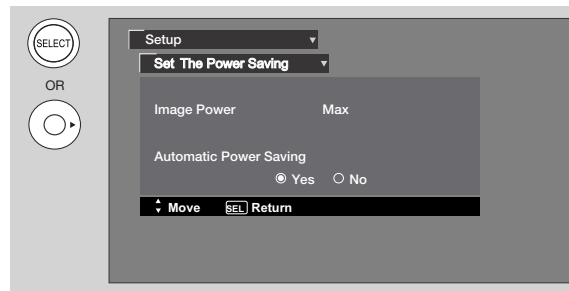

NOTE: This feature works only for INPUT 1, 2, 3, Front and HDMI 1, 2, Front.

Setup

Set The Inputs

Use this feature to give a name to any of the video inputs.

1. Press the **CURSOR PAD** ▲, ▼ to highlight the video inputs.
2. Press the **CURSOR PAD** ◀, ▶ to select your choices.

NOTA: The inputs labeled *Gray Out(Skip)* or *Hide(Skip)* are disabled in the **INPUTS** selection.

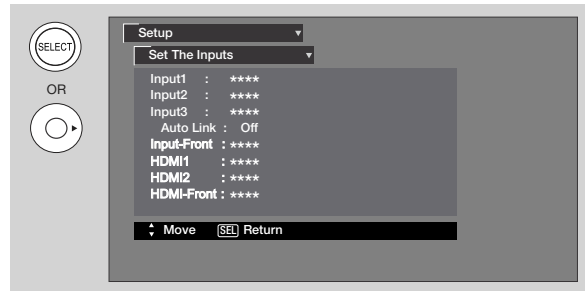
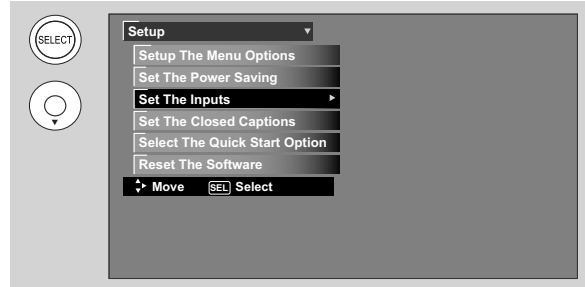

INPUT 3 Auto Link

Use this function to automatically turn the TV on and tune to INPUT 3 when it detects a video signal to INPUT 3.

1. Use the **CURSOR PAD** ▲ or ▼ to highlight the AUTO LINK option and ◀ or ▶ to change between the Off and Auto.

Auto

When **AUTO** is selected, the TV will turn on and switch to INPUT 3 automatically, when the INPUT 3 input device is turned on. This is convenient when you want to watch a movie with your VCR, laserdisc player, or DVD player.

Off

Select **OFF** to disable this function.

2. Press **EXIT** to quit menu or select SET THE INPUTS to return to previous menu.

NOTE: 1. Once the TV has been turned on using the **AUTO LINK** feature, it must be reset before **AUTO LINK** is used again. To do this, turn your VCR, laserdisc, or DVD player OFF. This feature is now reset and will turn on your TV as described above.

2. If no remote control button is pressed after the TV is turned on by **AUTO LINK**, the TV will automatically turn off after three hours.

Setup

Set The Closed Captions

Closed Captions are the dialogue, narration, and/or sound effects of a television program or home video which are displayed on the TV screen. Your local TV program guide denotes these programs as **CC** or .

1. Use the **CURSOR PAD** **◀**, **▶**, **▲** and **▼** to highlight and select the function to change.
2. Press **EXIT** to quit menu or select **SET THE CLOSED CAPTIONS** to return to the previous menu.

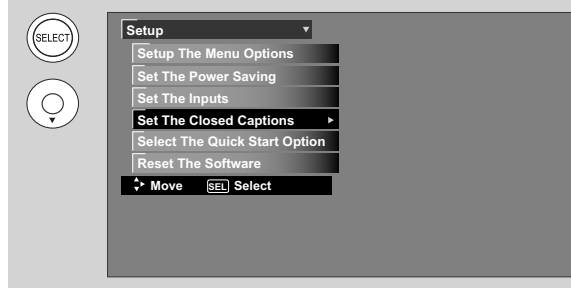

Caption Display:

ON/OFF will turn the **CC** display on or off.

AUTO will turn the **CC** display on when Mute/Soft Mute is on.

Analog Captions:

Set **CAPTIONS** for Analog programs. This function will help choose and set available mode and channel.

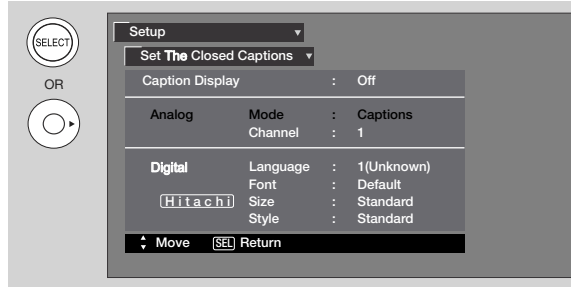

Caption Mode:

CAPTIONS is for the program you are viewing.

TEXT is for additional information such as news reports or a TV program guide. This information covers the entire screen and viewing the TV program is not possible. Text may not be available with every **CC** program.

Channel:

- 1 is used for the primary language (usually English).
- 2 is sometimes used for a second language (may vary by region).
- 3 is sometimes used for a third language (may vary by region).
- 4 is sometimes used for a fourth language (may vary by region).

Digital Captions

Set captions for digital programs. This function will help choose and set available language, font, size and style of digital captions.

1. Use the **CURSOR PAD** **◀**, **▶**, **▲** or **▼** to highlight and select desired **DIGITAL CAPTIONS** feature.
2. Press **EXIT** to quit menu or select **SET CLOSED CAPTION** to return to the previous menu.

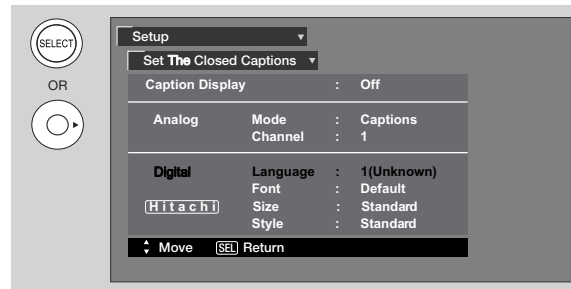

- NOTE:**
1. Some types of digital closed captions will not work with this TV.
 2. Caption Display will not work when viewing a 480p, 720p, or 1080i input via the **COMPONENT: Y-PbPr** inputs.
 3. Digital Captions Font Style are sometimes different from the Font Style of Analog Captions.
 4. Closed Caption and Digital Captions availability and content depends on the broadcaster. Closed Caption is available when Closed Caption icon is displayed on screen.
 5. Digital Captions language will not be available (grayed out) when using analog channels.

Setup

Select The Quick Start Option

This feature will select **QUICK START UP** options. Set this feature to **ON** to have the TV tune channels (both Analog and Digital) quickly when first turning the TV on. Set this feature to **OFF** to save electricity. Selecting **ON** for the **QUICK START UP** feature will activate the TV tuners circuits when the TV is in "standby mode" which is commonly referred to as "off". This will allow you to quickly tune to channels when first turning the TV on. Digital signals often change and this feature will monitor any changes and prepare the television to quickly present a picture. A small amount of electricity is used to continually monitor signals when this feature is selected.

Reset The Software

This feature shows software information and easy upgrade procedure. This function allows the TV software to be upgraded by using a flash card (**MMC/SD CARD**). If a future software upgrade is required for your TV, **HITACHI** will notify and provide you with a flash card. In order to receive written notification and the flash card, please complete and return the warranty card.

1. Insert **MMC/SD CARD**.
2. Press the **CURSOR PAD ▲** or **▼** to highlight **UPGRADE NOW**.
3. Press the **SELECT** button to select and start upgrading.
4. Unplug the AC power cord or press the **POWER** for 5 seconds when the **UPGRADE** is complete.

NOTE: Any power interruption during the upgrade process will cancel the upgrade. When this happens, repeat the upgrade procedure.

Reset TV Settings

This function allows you to Reset all TV Settings to the original factory settings on all modes during the next power off/on.

1. Use **CURSOR PAD ▲, ▼** to highlight functions.
2. Press the **SELECT** button or **CURSOR PAD ►** to select Reset the Software Menu.
3. Use the **CURSOR PAD ▼** to access the Reset TV settings option.
4. Select the **"YES"** option to Reset ALL the TV functions and unplug the power cord or press the **POWER** button for 5 seconds.

NOTE: 1. If **YES** is selected, **ALL TV MENU SETTINGS** will be reset to the original factory settings on all modes during the power cord is unplugged once or the **POWER** button is pressed for 5 seconds .
2. When the **Quick Start Option** has been set to **ON** , the option of Reset TV Settings will not operate unless the power cord is unplugged once or the **POWER** button is pressed for 5 seconds.

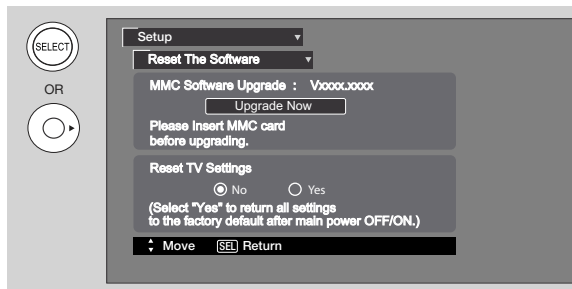
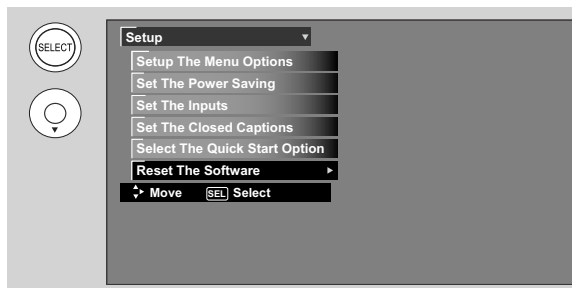
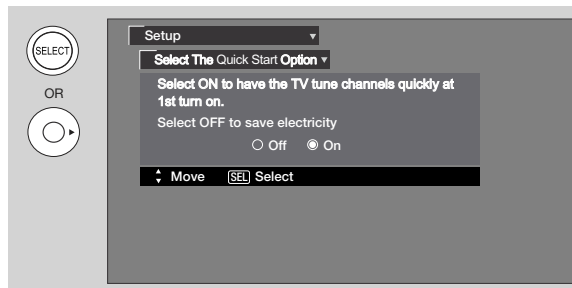
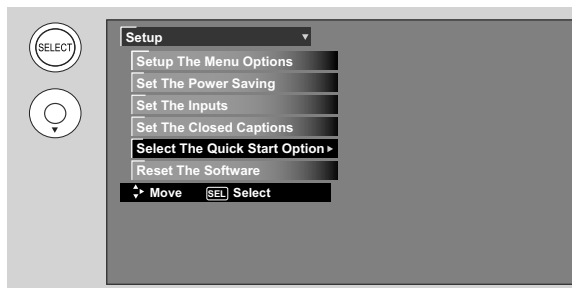

Power Swivel

Power Swivel

This feature controls the motorized stand. It allows the customer to turn the LCD Television left or right using the remote control. This feature is only available when the Table Top Stand is connected (see page 6).

1. Use the **CURSOR PAD** ◀ or ▶ to unlock or lock the Power Swivel.
Exit the OSD menu system before controlling the motorized stand.
2. Press the **CURSOR PAD** ▶ to rotate the TV to the right.
3. Press the **CURSOR PAD** ◀ to rotate the TV to the left.
4. Release the **CURSOR PAD** to stop rotation.

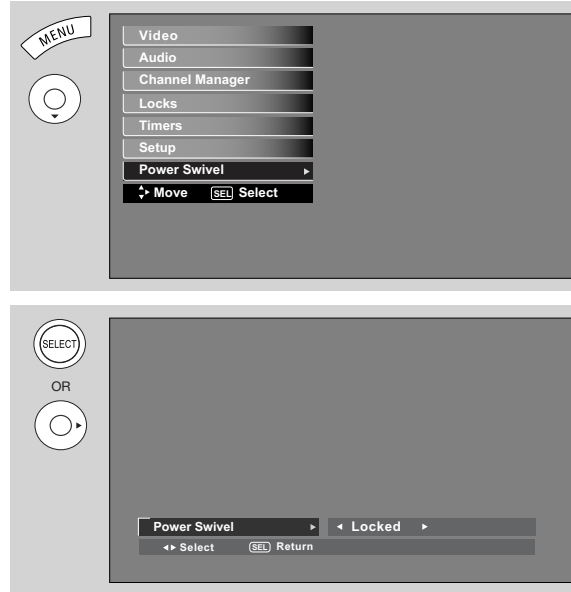

- NOTE:**
1. The Power Swivel has a maximum turning angle of 30° (left and right).
 2. Do not place any objects in the path of the LCD television when using the power swivel feature.
 3. Before using the power swivel, please make sure that the path of the LCD television is clear of any fingers, hands or any other body parts to avoid causing injury.

Equipment Care and Troubleshooting

DO

- Dust the screen and cabinet with a soft cloth.
- Clean the screen with a soft cloth moistened in warm water and dry with a soft cloth. A mild soap may be used if the screen is extremely dirty.
- Place your LCD Television away from extreme heat, humidity, and extremely dusty places.
- Remove the plug from the wall outlet if your LCD Television will not be used for a long period of time, for instance, when you go on vacation.

DO NOT

- Do not clean your screen with strong cleaners, polishes or a chemically treated cloth.
- Do not place rubber or vinyl products or cellophane tape on your LCD Television.
- Avoid repeatedly touching the screen.
- Do not subject the remote control to shocks such as dropping it on the floor, etc. This may cause damage to the precision parts.
- Avoid placing the remote control in a high humidity place or getting it wet. Do not leave it on or near a heater. Excessive heat or moisture may cause the unit to fail.
- When the batteries run down, remote control operation will become erratic or become unresponsive. Replace the old batteries with two new "AA" size batteries. Do not use an old battery with a new battery.
- Exposing the screen to direct sunlight for a long period of time or heat may cause damage to the LCD screen.

TROUBLESHOOTING

Your **HITACHI** LCD Television incorporates advanced power surge protection technology designed to protect against component or circuit damage due to external or internal voltage power surges.

IF YOUR TELEVISION SHOULD APPEAR TO HAVE A LOSS OF POWER, PLEASE FOLLOW THIS PROCEDURE:

1. Press the **POWER BUTTON (ON/OFF SWITCH)** once.
2. If there is still no power, wait 30 seconds and press the **POWER BUTTON** again.
3. If there is still no power, unplug the power cord from the wall. Wait 30 seconds and plug the power cord back in. Press the **POWER BUTTON** again.

This protective technology should provide for years of lasting entertainment from your **HITACHI** LCD Television.

SYMPTOMS	CHECK THESE ITEMS AND TRY THESE ADJUSTMENTS										
	Be sure external connection is correct	Be sure power cord is plugged in	Be sure TV is switched "ON"	Try another channel (station trouble)	Check antenna connections (back of TV)	Check antenna for broken/lead-in wire	Check for local interference	Adjust Contrast control	Adjust Brightness control	Adjust Color control	Adjust Tint control
No Picture, no sound	●	●	●	●	●	●					
Sound OK, picture poor	●			●	●	●	●	●			
Picture OK, sound poor	●			●	●	●	●				●
Picture blurred	●			●	●	●	●				
Lines or streaks in picture				●	●	●	●				
Poor reception on some channels				●	●	●	●				
Picture rolls vertically				●			●				
No color	●			●	●	●	●		●		
Poor color	●			●	●	●	●		●	●	

Reception Problems



IGNITION NOISE:

Black spots or horizontal streaks may appear, picture may flutter or drift. Usually caused by interference from automobile ignition systems, neon lamps, electrical drills, and other electrical appliances.



GHOSTS:

Ghosts are caused by the television signal following two paths. One is the direct path and the other is reflected from tall buildings, hills or some other objects. Changing the direction or position of the antenna may improve reception. Ghosting may also be caused by defects in the antenna system such as unshielded leads or connecting several sets to the same antenna without using multiple antenna couplers.



SNOW:

If your receiver is located in the fringe area of a television station where the signal is weak, your picture may be marred by the appearance of small dots. When the signal is extremely weak, it may be necessary to install a special antenna to improve the picture.

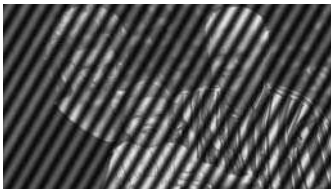

RADIO FREQUENCY INTERFERENCE:

The interference produces moving ripples or diagonal streaks, and in some cases, causes loss of contrast in the picture.

• PREVENTION OF AN OBSTACLE TO RADIO RECEIVERS

This television has been designed pursuant to the FCC class B Rules. This is to prevent a problem to Radio receivers. If this television causes a problem to Radio receivers, then take the following steps:

- Keep the television away from Radio.
- Adjust Radio antennas in order for the television not to receive interference.
- The antenna cable of Radio should be kept away from the television.
- Use a coaxial cable for antenna.

You can check if this television influences Radio receivers by turning off all other equipment other than the television. If you find a problem receiving Radio when using the television, check the instructions mentioned above.



BLOCK NOISE (DIGITAL INPUT):

Fuzzy blocks may appear in some area or the whole area of the screen. This is usually caused by interference from automobile ignition systems, neon lamps, electrical drills, ghosting of the image and weak signals.

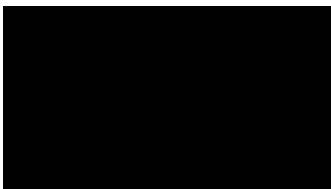

BLACK SCREEN:

When using an antenna, weak signals will display a black screen. It may be necessary to upgrade your antenna.

NOTE: The TV set can generate sound distortion in external devices such as a radio. Please separate radio equipment from the TV set to a considerable distance.

AGENCY REGULATORY INFORMATION

Federal Communications Commission Notice

This equipment has been tested and found to comply with the limits for a Class B digital device, pursuant to Part 15 of the FCC Rules. These limits are designed to provide reasonable protection against harmful interference in a residential installation. This equipment generates, uses and can radiate radio frequency energy and if not installed and used in accordance with the instructions, may cause harmful interference to radio communications. However, there is no guarantee that interference will not occur in a particular installation. If this equipment does cause harmful interference to radio or television reception, which can be determined by turning the equipment off and on, the user is encouraged to try to correct the interference by one or more of the following measures:

- Reorient or relocate the receiving antenna.
- Increase the separation between the equipment and the receiver.
- Connect the equipment into an outlet on a circuit different from that to which the receiver is connected.
- Consult the dealer or an experienced radio/television technician for help.

FCC Information

This device complies with part 15 of the FCC Rules. Operation is subject to the following two conditions :

- (1) This device may not cause harmful interference and
- (2) This device must accept any interference received, including interference that may cause undesired operation.

Modifications



The FCC requires the user to be notified that any changes or modifications made to this device that are not expressly approved by Hitachi America ,Ltd. Home Electronics Division may void the user's authority to operate the equipment.

Cables

Connections to this device must be made with shielded cables with metallic RFI/EMI connector hoods to maintain compliance with FCC Rules and Regulations.

Any cables that are supplied with the system must be replaced with identical cables in order to assure compliance with FCC rules. Order Hitachi spares as replacement cables.

Note

This LCD Television receiver will display television closed captioning, ( or ), in accordance with paragraph 15.119 and 15.122 of the FCC rules.

INDUSTRY CANADA AGENCY REGULATORY INFORMATION

Cable Compatible Television Apparatus- Télévision câblocompatible, Canada.

Features and Specifications

Features:

- New 1080P Full HD LCD Display Panel
- New Easy-to-Use On-Screen Menu Control (3 Language)
- Region 5 (Downloadable V-Chip)
- Preprogrammed Remote Control
- Power Management: ON/OFF via signal detection
- Picture Enhancement
- Input Signal Identification
- HDMI (High Definition Multimedia Interface)(High Bandwidth Digital Content Protection V1.1 Compatible)
- Closed Captions (Analog and Digital)
- Sleep and Event Timer
-  Technology
- Lip Sync control

Video:

- 1920 x 1080 Display Resolution
- IPS (In Plane Switching Technology)
- Wide Viewing Angle: More than 178°
- Color Temperature Presets: High, Medium, Standard and Black/White.
- Multiple Screen Fill Modes
(4:3 Standard/4:3 Expanded/4:3 Zoom 1/
4:3 Zoom 2/16:9 Standard1/Standard2/16:9 Zoom)1
- 4MB 10-bit 3D Y/C Comb Filter
- Picture Modes :Day(Normal), Day(Dynamic) and Night

Inputs:

- Power InputAC 120V, 60Hz
- Power Consumption
Average Power : L47S601 - 303 W
. L42S601 - 215 W
Maximum Power : L47S601 - 303 W, 2.55 A
. L42S601 - 215 W, 1.85 A
- Antenna input impedance75 Ohm
- Channel coverage 191ch.
VHF-Band 2 ~ 13
UHF-Band 14 ~ 69
CATV Mid Band A-5 ~ A-1
. A-I
Super Band J-W
Hyper Band W+1 - W+28
Ultra Band W+29 - W+94
- Television System NTSC Standard
ATSC Standard (8 VSB, 64-QAM, 256-QAM)
- Video 1.0Vp-p, 75 Ohm
- S-Video
Luminance (Y) 1.0Vp-p, 75 Ohm
Chrominance (C) 0.286Vp-p, 75 Ohm
- Component Video
Luminance (Y) 1.0Vp-p, 75 Ohm
Chrominance (P_B/P_R) 0.7Vp-p, 75 Ohm
- Audio input Impedance 270k Ohm
- Average input level 470mVrms
- HDMI (19 PIN)

Outputs:

- Video 1.0Vp-p, 75 Ohm
- Audio470mVrms, 1k Ohm
- Optical Out (Digital Audio)1 Optical Connector

Audio:

- MTS Stereo/SAP
- Bass Boost
- Surround Sound
- 20W
- Soft Mute (50%)

Supplied Accessories:

- Remote Control
- Batteries (AA)
- 6' AC Power cord cable
- Power Swivel Table Top Stand (assembled)
- Power Swivel cable

Optional Accessories:

- For U.S. Models: Please access our website:
www.hitachi.us/tv
- For Canada Models: Please access our website:
www.hitachi.ca/tv

INPUTS/OUTPUTS

- Wideband Component Y, Pb,Pr 2
- Composite Video 4
- S-Video 1
- Antenna (RF)Inputs 1
- Audio Output 1
- Monitor Output 1
- Optical Output 1
- Upgrade Card Slot 1
- HDMI 3
- RS232C Interface 1

SPECIFICATIONS

- Pixel Pitch:
L47S601. 0.5415(horiz.) x 0.5415(vert.) mm.
L42S601. 0.4845(horiz.) x 0.4845(vert.) mm.
- FCC class: B for Consumer Use
- Power Requirements 108-132VAC, 60Hz
- Operation Temperature 41°F a 95°F

¹ Screen mode availability varies by input format

HDTV Televisions display HDTV only when an HDTV source is available.

All specifications, weights, and dimensions are subject to change without prior notice. Please access www.hitachi.us/tv for detailed specifications and dimensions for custom installations.

UltraVision Digital is a registered trademark of Hitachi Home Electronics (America), Inc.



COPYRIGHT © 1999-2007 MONTAVISTA SOFTWARE, INC. ALL RIGHTS RESERVED.

 HDMI, the HDMI logo and High-Definition Multimedia Interface are trademarks or registered trademarks of HDMI Licensing LLC.

*Manufactured under license from Dolby Laboratories. "Dolby" and the double-D symbol are trademarks of Dolby Laboratories.

Set Dimensions

47 Inch Models (Includes Table Top Stand) Weight (lbs./kg): 74.3/33.7
 42 Inch Models (Includes Table Top Stand) Weight (lbs./kg): 61.3/27.8

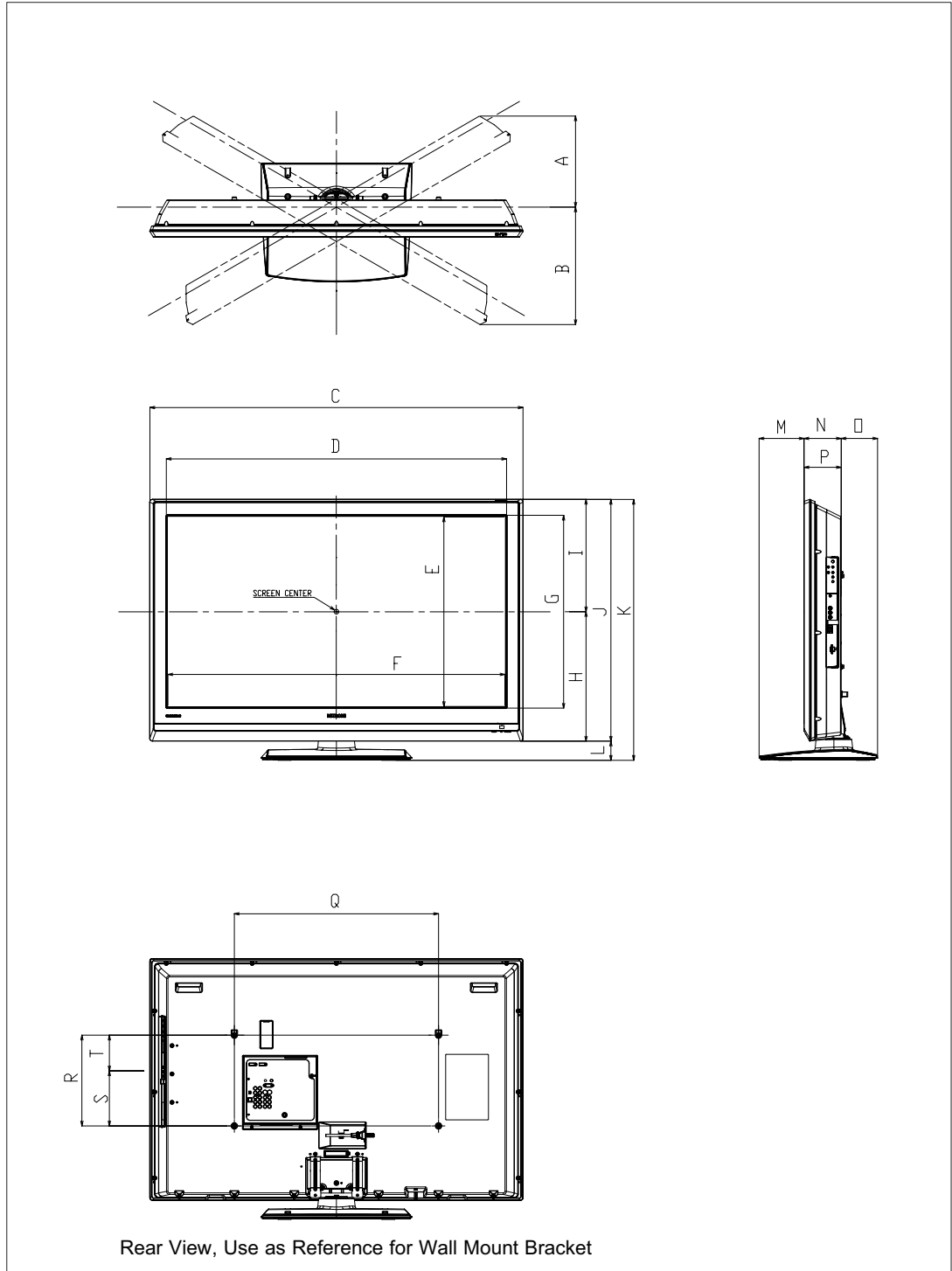

47"

Units	A	B	C	D	E	F	G	H	I	J	K	L	M	N	O	P	Q	R	S	T
Inches	11-1/16	14-1/4	45-5/16	41-5/16	23	40-15/16	23-7/16	15-3/4	13-5/8	29-3/8	31-11/16	2-5/16	5-7/16	4-1/2	4-7/16	4-1/2	24-13/16	11	6-11/16	4-5/16
mm	281.05	362.26	1151.30	1050	584.82	1039.68	595	399.40	346.60	746	805	59.10	138.70	114.70	112.08	114.18	630	280	169.80	110.20

42"

Units	A	B	C	D	E	F	G	H	I	J	K	L	M	N	O	P	Q	R	S	T
Inches	10	13-3/16	41	36-13/16	20-9/16	36-5/8	20-3/4	14-1/2	12-7/16	26-15/16	29-1/4	2-5/16	5-7/16	4-1/2	4-7/16	4-1/2	24-13/16	11	6-11/16	4-5/16
mm	253.56	334.77	1041.70	934.5	523	930.20	527	368.40	315.60	684	743	59.10	138.70	114.70	112.10	114.18	630	280	169.80	110.20

HITACHI

Inspire the Next

Service Hotline

To locate an authorized **HITACHI** service facility in the continental U.S.A. and Canada,

DIAL TOLL FREE

7 days a week, 24 hours a day

1-800-HITACHI

(1-800-448-2244)



HITACHI AMERICA, LTD.
HOME ELECTRONICS DIVISION

HITACHI has made every effort to assure you hours of trouble free operation from your unit. However, should you require service, a network of **HITACHI** Authorized Service Facilities has been established in all 50 states and Puerto Rico. Each facility will provide you with convenient and expedient assistance. Our service hotline operator will direct you to the **HITACHI** Authorized Service Facility nearest you. Just present proof of purchase and/or delivery receipts to the Hitachi Authorized Service Facility, and service will be rendered in accordance with the terms of the limited warranty as stated on your warranty card or operating guide.

Should you have any questions regarding warranty, service, operation, or technical assistance, please contact:

Hitachi America, LTD.
Home Electronics Division
900 Hitachi Way
Chula Vista, CA 91914-3556

HITACHI CANADA, LTD.
DIGITAL MEDIA DIVISION

Should you have any questions regarding warranty, service, operation, or technical assistance, please contact:

In Canada: 1-800-HITACHI (1-800-448-2244)

Monday – Friday (EST).....9:00am – 7:00pm
Saturday (EST)9:00am – 5:00pm

Pour de plus amples renseignements sur le service durant la période couverte par la garantie, sur le fonctionnement ou pour de l'assistance technique communiquez avec:

Au Canada: 1-800-HITACHI (1-800-448-2244)

Lundi - Vendredi L'EST9:00am – 7:00pm
Samedi L'EST.....9:00am – 5:00pm

HITACHI CANADA, LTD.
1-2495 Meadowpine Blvd.
Mississauga, Ontario L5N 6C3

Service Information

When you call HITACHI SERVICE HOTLINE they will require some information related to the TV MODEL NAME and SERIAL # in order to give you the proper support. This information is located on the back of the TV and also on the RIGHT SIDE of your TV set. Please follow the next steps to find this information and then provide to SERVICE.

- 1 Look on the right side of the TV.
- 2 Locate the LABEL where it shows the information related to MODEL NAME and SERIAL #.
- 3 HITACHI Service Department will require this information in order to give you the proper support regarding your questions.

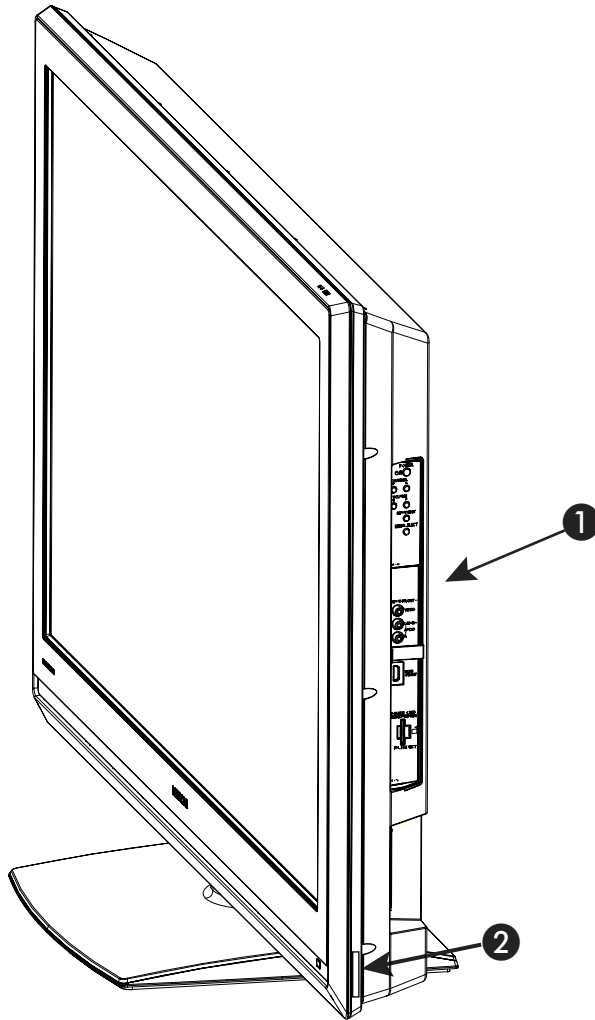

HITACHI

Inspire the Next

TELEVISOR de LCD Pantalla Plana

Guía de funcionamiento para L47S601 y L42S601

INSTRUCCIONES IMPORTANTES DE SEGURIDAD.....	66-67
USO POR PRIMERA VEZ	68-85
EL CONTROL REMOTO	86-97
MENÚ EN PANTALLA	98-121
INFORMACIÓN ÚTIL	122-128

ULTRAVISION

Instrucciones Importantes de Seguridad



PUNTOS DE SEGURIDAD QUE USTED DEBE SABER SOBRE SU TELEVISOR DE LCD HITACHI

Nuestra reputación se ha formado en base a la calidad, desempeño y facilidad de servicio de los televisores de LCD pantalla plana **Hitachi**.

La seguridad está en primer lugar en nuestra mente al diseñar estas unidades. Para ayudarlo a operar estos productos en forma apropiada, esta sección ilustra datos de seguridad que serán de beneficio para usted. Léalos cuidadosamente y aplique los conocimientos adquiridos para operar con propiedad su televisor de LCD pantalla plana **Hitachi**.

Complete su tarjeta de garantía y envíela por correo a **Hitachi**. Esto le permitirá a **Hitachi** notificarlo rápidamente en el caso improbable de que se descubra un problema de seguridad en el modelo de su televisor.

Siga todas las advertencias e instrucciones marcadas en este televisor de LCD pantalla plana.



PRECAUCIÓN
RIESGO DE DESCARGA ELÉCTRICA NO ABRIR



AVISO: PARA REDUCIR EL RIESGO DE DESCARGA ELÉCTRICA, NO RETIRE LA CUBIERTA NI EL PANEL POSTERIOR. EN EL INTERIOR DEL APARATO NO EXISTEN PARTES QUE DEBAN SER REPARADAS POR EL USUARIO. SOLICITE SERVICIO O REPARACIÓN A PERSONAL CALIFICADO.



El símbolo del rayo dentro de un triángulo equilátero tiene por finalidad alertar al usuario acerca de la presencia de voltaje peligroso (sin aislamiento) en el interior del producto, que puede tener la intensidad suficiente como para considerar un riesgo de descarga eléctrica.



El signo de exclamación dentro de un triángulo equilátero tiene por finalidad alertar al usuario de instrucciones importantes de operación y mantenimiento (servicio) en la literatura que acompaña a este aparato.

LEA ANTES DE HACER FUNCIONAR EL EQUIPO

Siga todas las advertencias e instrucciones indicadas en este televisor de LCD pantalla plana.

1. Lea estas instrucciones.
2. Conserve las instrucciones.
3. Tomar en cuenta todos los avisos.
4. Siga todas las instrucciones.
5. No utilice este aparato cerca del agua.
6. Limpie el equipo con un paño seco y suave.
7. No bloquee las rendijas de ventilación. Instale el equipo según las instrucciones del fabricante.
8. No lo instale cerca de fuentes de calor, como radiadores, registros de calor, hornos o demás aparatos (incluidos amplificadores) que produzcan calor.
9. No altere la función de seguridad de la clavija de tipo conexión a tierra. La clavija de tipo conexión a tierra tiene dos terminales y una tercera terminal de conexión a tierra. La tercera terminal se incluye para su seguridad. Si la clavija suministrada no encaja en la toma, póngase en contacto con un electricista para que cambie el receptáculo (enchufe).

10. Proteja el cable de alimentación para que no se pise ni esté retorcido, especialmente en las clavijas, los receptáculos y el punto por el que sale del aparato.
11. Utilice únicamente los accesorios especificados por el fabricante.
12.  Utilice únicamente el carro, mueble, tripie, soporte o mesa especificado por el fabricante o de venta con el aparato. Si utiliza un carro, tenga cuidado al mover el aparato para evitar que se caiga y provoque lesiones personales.
13. Desconecte el equipo durante tormentas eléctricas o cuando no lo vaya a utilizar durante periodos prolongados.
14. Para tareas de mantenimiento, diríjase a personal calificado. Será necesario recurrir a tareas de mantenimiento si el aparato sufre daños de cualquier tipo, si el cable de alimentación o la clavija están dañados, si ha caído líquido u otros objetos en el aparato o si éste ha sido expuesto a la lluvia o humedad, si no funciona con normalidad o se ha caído.
15. Los televisores están diseñados para cumplir con los estándares de seguridad recomendados para inclinación y estabilidad. No aplique fuerza excesiva a la parte superior o frontal de gabinete que pudiera hacer que el televisor se caiga causando daño del producto y/o daño personal.
16. Siga las instrucciones de montaje en la pared, estante o techo según lo recomendado por el fabricante.
17. Una antena exterior no deberá ser instalada en la cercanía de líneas de alimentación externas ni de otros circuitos de iluminación eléctrica.
18. Si se conecta una antena externa ó sistema de cable a la unidad, cerciórese de que el sistema de antena ó cable está conectado a tierra para darle protección contra sobretensión y acumulación de carga estática. La Sección 810 del Código Nacional de Electricidad, ANSI/NFPA 70-1984, proporciona información con respecto a como poner a tierra el mástil apropiadamente y la estructura de sostenimiento, al poner a tierra el alambre de entrada a una unidad de descarga de la antena, tamaño de los conectores para poner a tierra, localidad de la unidad de descarga de antena, conexión de los electrodos a tierra y los requisitos para el electrodo que pone a tierra.

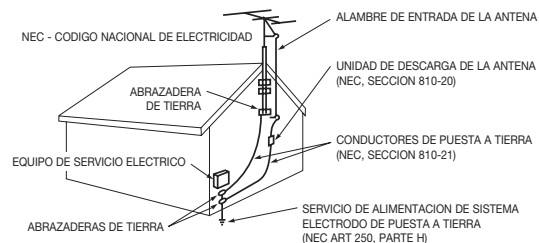

Nota para el instalador del sistema CATV. Este recordatorio se provee para llamar la atención del instalador de sistema CATV hacia el Artículo 820-44 de la NEC que brinda guías para una puesta a tierra apropiada y en particular, especifica que la tierra del cable debe conectarse al sistema de tierra del edificio, tan próximo a la entrada de cable como sea más práctico.

Instrucciones Importantes de Seguridad



Fuente de energía

Este televisor de LCD está diseñado para operar con corriente CA, 120 voltios 60 Hz. Inserte el cable de electricidad en un tomacorriente de 120 voltios a 60 Hz. La clavija se utiliza como dispositivo de desconexión y continúa estando disponible.

Para impedir descarga eléctrica, no utilice la clavija (polarizada) del televisor de LCD con una extensión, receptáculo u otro enchufe a menos que los terminales y el terminal de tierra puedan insertarse completamente para evitar que la terminal este expuesta.

Nunca conecte el televisor de LCD a 50 Hz, corriente directa o cualquier otro voltaje que no sea el especificado.

Precaución



Nunca quite la tapa trasera del televisor de LCD ya que puede exponerlo a voltajes muy altos y a otros peligros. Si el televisor no funciona en forma apropiada, desenchufe el televisor de LCD y llame a su distribuidor o centro de servicio autorizado.

Precaución

Ajuste solamente los controles que se incluyen en las instrucciones, ya que cambios inapropiados o modificaciones que no estén expresamente aprobadas por **Hitachi** podrían anular la garantía.

Advertencia

- Para reducir el riesgo de fuego o shock eléctrico, no exponga el aparato a lluvia o humedad.
- El televisor de LCD no se debe exponer a filtrado o salpicado de líquidos y a objetos con líquidos, tales como floreros que no se deben colocar sobre el televisor.
- Este aparato se debe conectar a la red de electricidad con una conexión de protección a tierra.

Visión pública de material con derechos de autor

La visión pública de programas transmitidos por estaciones de televisión o compañías de cable, así como programas de otras fuentes, puede requerir autorización previa del difusor o propietario del material de programa de video.

Este producto incorpora la tecnología de protección de derechos de autor, que está protegida por demandas de métodos de ciertas patentes de EE.UU. y otros derechos de propiedad intelectual. El uso de la tecnología de protección con derechos de autor debe ser autorizada, y es solo para uso en el hogar u otros usos limitados al consumidor a menos que sea autorizado. Está prohibida la ingeniería inversa o el desmontaje.

Nota

Este televisor digital es capaz de recibir programación básica analógica, básica digital de televisión por cable, mediante la conexión directa a un sistema de cable que provea tal programación. Ciertos servicios de cable digital interactivos tales como video-on-demand (sobre pedido), una guía de programas mejorada del operador de cable y servicios de transmisión de datos por televisión pueden requerir el uso de un decodificador. Para mayor información llame a su compañía de cable local.

Nota

- No existen partes reemplazables por el usuario dentro del televisor de LCD.
- Los números de serie y modelo se indican en la parte posterior y el lado derecho del televisor de LCD.

Aviso sobre el Plomo y Mercurio

 Este producto contiene plomo y una o más lámparas irremplazables de mercurio. No tirar en la basura. Reciclar o disponer de acuerdo a las leyes aplicables. Para información de reciclaje y desecho, contactar a su agencia local de gobierno o visitar la página de internet www.aiae.org (en EE.UU.) ó www.epsc.ca (in Canadá). PARA MAYOR INFORMACIÓN, LLAME AL **1-800-HITACHI**.

Accesorios

Asegurarse de que tiene los siguientes accesorios antes de desechar el material de empaque.

1 Control Remoto

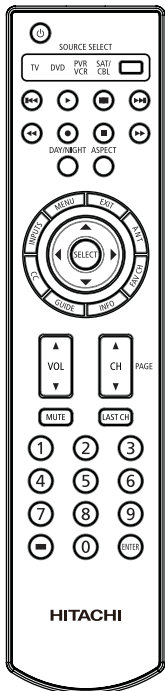

2 Dos baterías tipo "AA" 1.5V

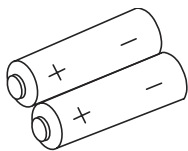

3 Cable de energía

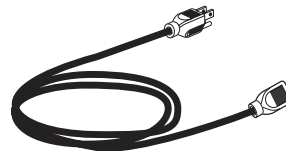

4 Cable para Base Giratoria



Para modelos de U.S.A. :

Para accesorios opcionales, visitar nuestro sitio de internet : www.hitachi.us/tv

Para modelos de Canadá :

Para accesorios opcionales, visitar nuestro sitio de internet : www.hitachi.ca/tv



PRECAUCIÓN: 1. El montaje en el techo no es recomendable. Montar el panel en el techo no provee la adecuada ventilación a lo electrónico ó el apropiado soporte al panel frontal de vidrio. Este televisor de LCD está diseñado para una inclinación máxima de 45° en vertical.

2. La base para la pared para los modelos 42" y 47" es WM07S. Favor de ver la página 71 para información importante relacionada con la base de la pared. La base es un accesorio opcional (No está Incluida).

- 1 Control Remoto CLU-4373A (No. Parte HL02403)
- 2 Dos baterías tipo "AA" , 1.5V.
- 3 Cable de energía (No. Parte EV01841).
- 4 Cable para Base Giratoria (No. Parte EW08434).

INSTALACIÓN Y REMPLAZO DE LAS BATERIAS DEL CONTROL REMOTO

1. Abrir la cubierta de las baterías del control remoto presionando la pestaña para quitar la cubierta.
2. Colocar dos baterías tipo "AA" para el control remoto. Al remplazar las baterías, empujar hacia los resortes y luego sacarlas.
3. Coincidir las marcas de las baterías (+) y (-) con las marcas del compartimiento.
4. Insertar la parte inferior de la batería, el lado (-) neg, en el compartimiento primero , luego empujar hacia los resortes e insertar la parte superior de la batería , el lado (+) pos, en su lugar. No forzar la batería dentro del compartimiento.
5. Colocar de nuevo la cubierta.

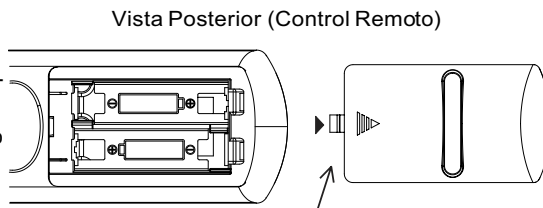

Vista Posterior (Control Remoto)

Presionar la pestaña para quitar la cubierta.



PRECAUCIÓN: No coloque la baterías con la polaridad '+' y '-' invertidas esto puede causar que las baterías se derramen dentro del compartimiento.

Cómo colocar su nuevo televisor de LCD HITACHI

Como tomar medidas para evitar que el televisor de LCD se incline e impedir posibles daños, es importante montar la unidad en una superficie estable y lisa.

Asegurando a una pared

1. Use el cable metálico (dos posiciones) y amarre el televisor de LCD al tornillo sujetador en la parte posterior como se muestra abajo.

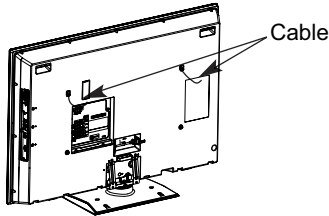

2. Mantenga el televisor de LCD a 4 pulgadas (10 cm) de la pared excepto cuando lo monta usando un soporte de montaje a la pared.
3. Asegure el televisor a la pared como se muestra en la fig.

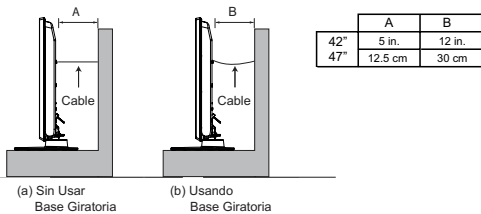

* Favor de ajustar la longitud del cable para evitar que la TV toque la pared al girarla.

- NOTAS:**
1. No bloquee los ranuras de ventilación del televisor de LCD. El bloqueo de agujeros de ventilación podría causar fuego o defectos.
 2. En caso de un síntoma anormal, desenchufe el cable de CA.
 3. Si compró el soporte de montaje a la pared, solicite un instalador profesional. No lo instale por su cuenta.
 4. Instale la unidad en un área apropiada donde no se exponga a nadie al peligro de golpearse (por ejemplo, manos cabeza o cara) contra el borde de la unidad y causar daño personal.
 5. Si la base giratoria no va a ser usada, el televisor LCD debe ser sujetado a la pared como se muestra en la fig. (a).
 6. Si la base giratoria va a ser usada, el Televisor LCD debe ser sujetado a la pared como se muestra en la fig. (b).



Precaución al mover la unidad principal

Como este producto es pesado, para moverlo, se requieren dos personas para transportarlo con seguridad. Cada vez que se mueva la unidad debe levantarse hacia adelante usando la parte superior y la base a ambos lados del televisor para lograr estabilidad. Cuando mueva el televisor, levante de las agarraderas que sostienen la estructura luego tomar de la parte superior como se muestra :

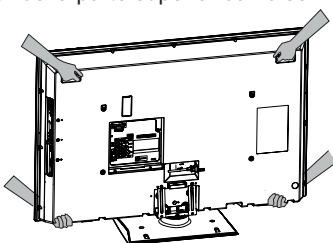

47" y 42"

ANTENA

A menos que su televisor de LCD esté conectado a un sistema de televisión por cable o a un sistema de antena externa, se recomienda una buena antena de televisión color para mejor rendimiento. Sin embargo, si se encuentra en un área con señal excepcionalmente buena sin interferencia y sin fantasmas en la imagen, una antena interior puede ser suficiente.

UBICACIÓN

Seleccione un área donde la iluminación interior o la luz solar no se dirijan directamente sobre la pantalla. También asegúrese de que la ubicación seleccionada permite un flujo libre de aire hacia y desde la tapa posterior del equipo. Para evitar el aumento de temperatura interna, mantenga un espacio de 4 pulgadas (10 cm) desde los lados y la parte posterior del televisor, y 30 cm (12 pulgadas) desde la parte superior del televisor al techo. Para evitar deformaciones del gabinete, cambios en el color del gabinete y mayor oportunidad de falla en el equipo, no coloque el televisor donde las temperaturas puedan volverse excesivamente cálidas por ejemplo, a la luz solar o cerca de un calefactor, etc.

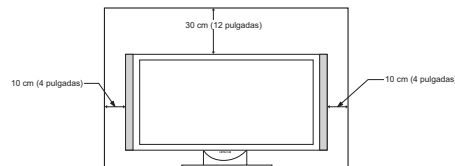

CONEXIÓN DE CABLE PARA BASE GIRATORIA

Conecte un extremo del cable al conector "SWIVEL" de la parte posterior del televisor de LCD. Conecte el otro extremo del cable al conector en la base giratoria. Para ver información más a detalle, por favor vea la instrucción de instalación en la página siguiente.

ANGULO DE ROTACIÓN

El máximo ángulo de rotación es 30° (Izq. y Der.). No colocar objetos en el paso del televisor al usar la base giratoria.

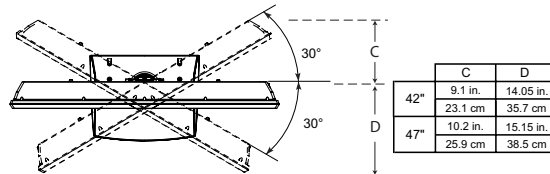

Cómo colocar su nuevo televisor de LCD Hitachi

INSTRUCCIÓN DE COMO COLOCAR EL CABLE DE AC Y EL CABLE DE LA BASE GIRATORIA

El cable de AC y el cable de la base giratoria que vienen incluidos en su nuevo Televisor de LCD necesitan ser ensamblados correctamente para evitar que se desconecte al girar el Televisor con su base. En el televisor existen 2 sujetadores de plástico localizados en la parte posterior del Televisor para sujetar el cable de AC y el cable de la base giratoria . Favor de seguir las siguientes intrucciones.

- 1 Pasar el cable de AC a través del sujetador #1 y conectarlo al televisor. Jalar el extremo del sujetador para sujetar el cable de AC con el televisor.
- 2 Conecte un extremo del cable de la base giratoria al conector "SWIVEL" de la parte posterior del televisor de LCD. Conecte el otro extremo del cable al conector en la base giratoria.
- 3 Los cables de señal, el cable de AC y para la base giratoria pueden ser sujetados con el sujetador #2.

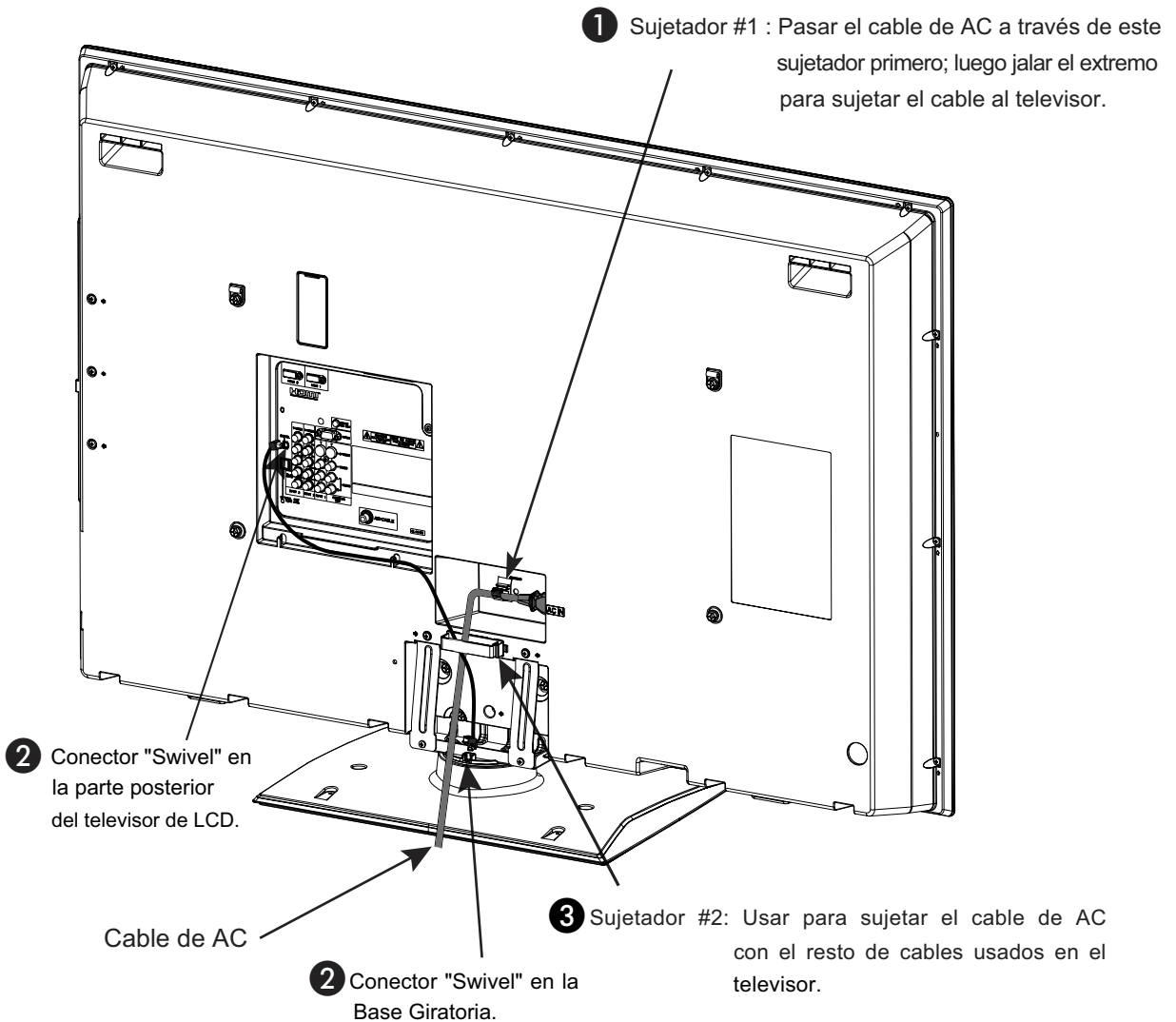

Cómo colocar su nuevo televisor de LCD Hitachi

CONFIGURACIÓN PARA MONTAJE EN LA PARED

PASO (1) :

Localizar los soportes de metal de la BASE en la parte posterior del televisor. Estos metales son usados para sostener el televisor y la base; se tienen que quitar 4 tornillos de los soportes para separar el televisor y la base.

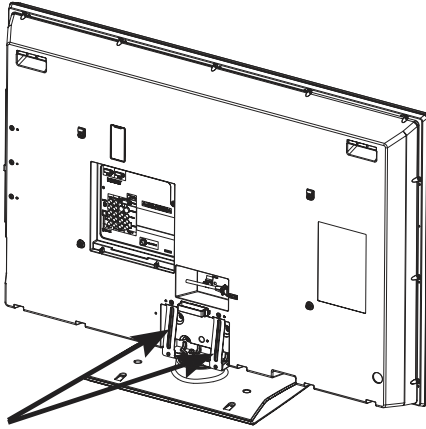

2 Soportes METAL de la BASE

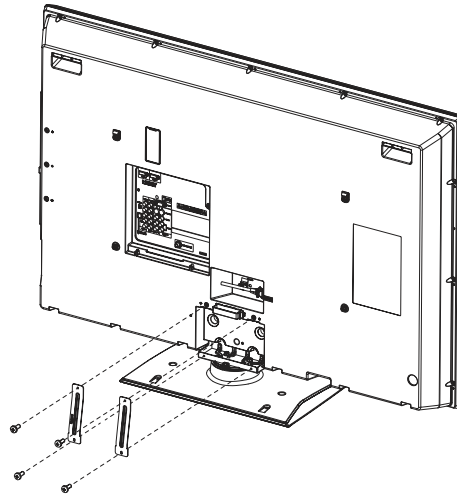

Quitar los 4 tornillos y luego remover los 2 soportes de metal.

PASO (2):

Ahora hay que quitar los 5 tornillos del metal de la BASE del Televisor , ahora la BASE puede ser separada del Televisor. Para dimensiones del ensamble en la PARED referirse a la página 126.

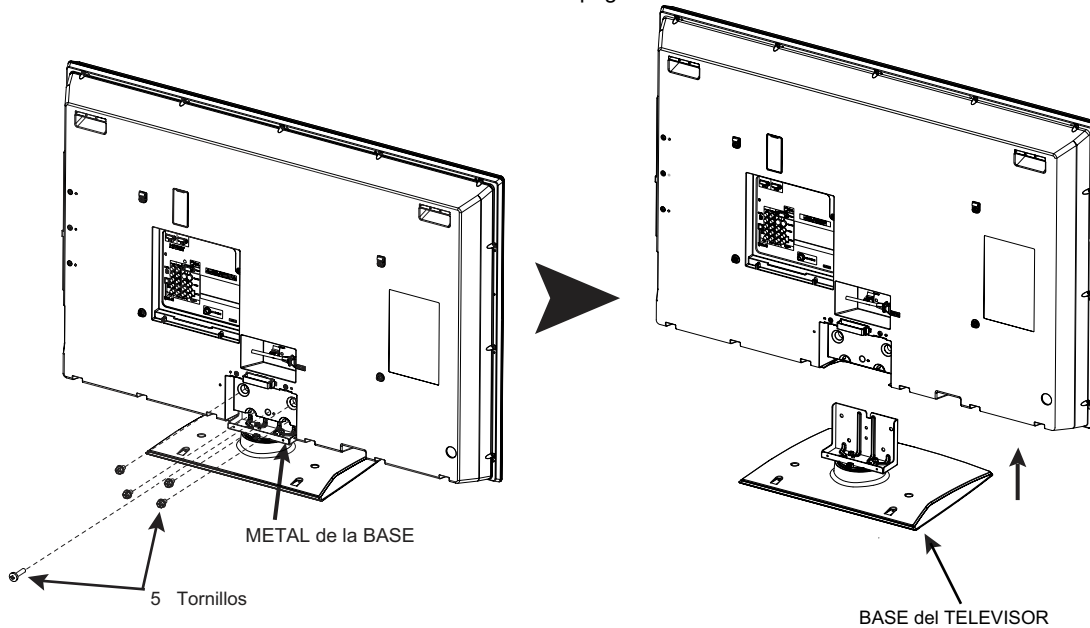

Para el Modelo L47S601 y L42S601

PRECAUCIÓN - Este televisor de LCD solo puede usar la base para la pared **WM07S** de Hitachi. Al usar otra base puede causar inestabilidad en el televisor provocando posibles heridas personales.

NOTA: Use la base para pared (WALL MOUNT) para el Televisor de LCD de acuerdo al tamaño. Visite nuestro sitio de internet: www.hitachi.us/tv para accesorios de su Televisor.

Cómo colocar su nuevo televisor de LCD Hitachi

Uso por primera vez

VISIÓN

La mejor posición para ver la imagen es en frente del televisor y de 10 a 18 pies lejos de la pantalla.

Durante las horas del día, las reflexiones o reflejos de luz externa pueden aparecer en la pantalla. Si esto sucede, pueden ser usadas cortinas para reducir el reflejo o la TV puede cambiarse de lugar en el cuarto.

Si el audio del televisor es conectado a las bocinas de un sistema de alta fidelidad (Hi-Fi), la mejor calidad de audio se obtendrá al colocar las bocinas equidistantes a los lados del receptor y los más cerca posible a la altura del centro de la imagen. Para una mejor separación de audio (stereo), coloque las bocinas por lo menos 4 pies de los lados del Televisor, coloque las bocinas traseras (surround speakers) a lado o detrás del ángulo de visión.

Diferencias en tamaño de los cuartos y ambientes acústicos requieren alguna experimentación con la colocación de las bocinas para una mejor calidad de audio.

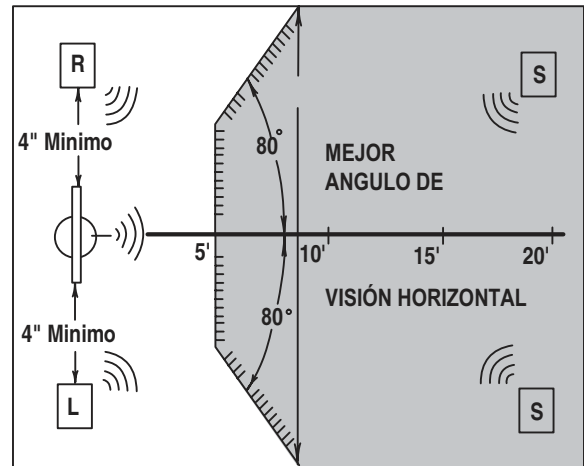

CONEXIONES DE ANTENA EN EL PANEL POSTERIOR

Antena VHF (75-Ohm) /CATV (Cable TV)

Al usar un sistema de cable coaxial 75-Ohm, conectar el cable coaxial de señal **CATV** a la terminal AIR/CABLE (75-Ohm). O si tiene una antena, conectar al cable coaxial a la misma terminal AIR/CABLE.

VHF (300-Ohm) antenna/UHF antenna

Al usar un cable plano de 300-Ohm de una antena externa, conectar los cables de la antena **VHF** ó **UHF** a los tornillos del adaptador **VHF** ó **UHF**. Insertar el adaptador a la terminal de antena en el TV.

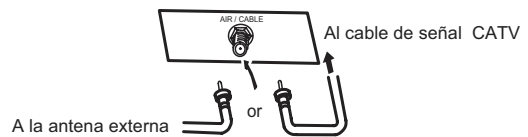

Al usar ambas antenas VHF y UHF conectadas

Usar un mezclador de cable/antena opcional conectado a la terminal de antena, y conectar los cables al mezclador. Consultar con su distribuidor o centro de servicio por los mezcladores de antena.

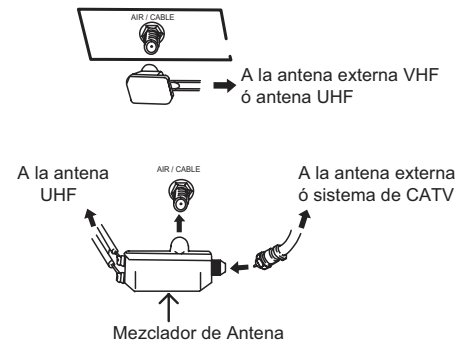

NOTA: Al conectar un cable plano de 300-Ohm puede causar interferencia. Es más recomendable usar un cable coaxial de 75-Ohm.

Cables y Conectores

La mayoría de las conexiones de audio/video entre equipos puede hacerse con cables blindados de audio y video que tienen conectores RCA. Para una mejor calidad, los cables de video deben ser coaxiales blindados de 75-Ohm. Los cables pueden ser comprados en la mayoría de las tiendas que vendan productos de audio/video. Enseguida unas ilustraciones y nombres de conectores. Antes de comprar cualquier cable, asegúrese de los tipos de conectores de salida y entrada requeridos por los diferentes tipos de equipos y el largo de cada cable.

Cable plano 300-Ohm doble hilo

Este cable de antena externa debe ser conectado a un adaptador de antena (300-Ohm a 75-Ohm).

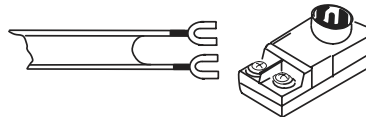

Cable Phono ó RCA

Usado en todos los cables de video y audio estándar los cuales conectan las entradas y salidas localizados en la parte posterior y panel de control lateral del televisor.



Cable Coaxial tipo "F" a 75-Ohm

Para conectar señales de RF (antena ó cable TV) a la terminal de antena en el televisor.



Cable S-Video (Super Video)

Este conector es usado en videocámaras, VCRs y reproductores de laser con la opción S-Video en lugar del cable de video estándar para producir una imagen de alta calidad.

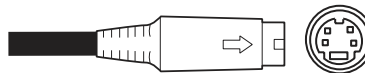

Cable Óptico

Este cable es usado para conectar a un amplificador de audio con entrada de Audio Óptica. Usar este cable para la mejor calidad de sonido.

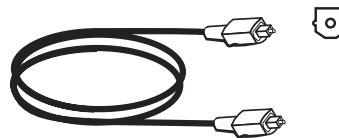

Cable HDMI

Este cable es usado para conectar sus equipos externos como Set-Top-Boxes ó reproductores de DVD equipados con salida HDMI conectada a la entrada HDMI del Televisor.

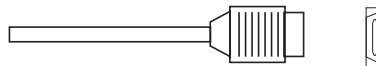

Cable Estéreo (Terminal audifono 3.8mm a 3.5mm)

Usado en todos los cables de audio y video estándar que conectan las entradas y salidas localizadas en la parte posterior o en el panel de control lateral del televisor.

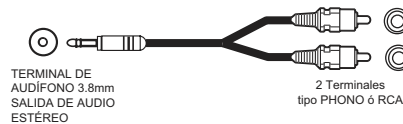

Cable de la Base Giratoria (Incluido)

Este cable se usa para conectar la base giratoria al panel posterior del Televisor de LCD.



Guía Rápida para las Funciones del Control Remoto

Además de controlar todas la funciones de su Televisor de LCD Hitachi, el nuevo control remoto es diseñado para operar diferente tipos de equipos, tales como, reproductores de DVD, CBL (Cajas de Cable), set-top-boxes, receptores de satélite, y VCRs. El control remoto debe ser programado para controlar el equipo deseado. Ver páginas 86-97 para una completa descripción de todas las opciones y como programar el Control Remoto.

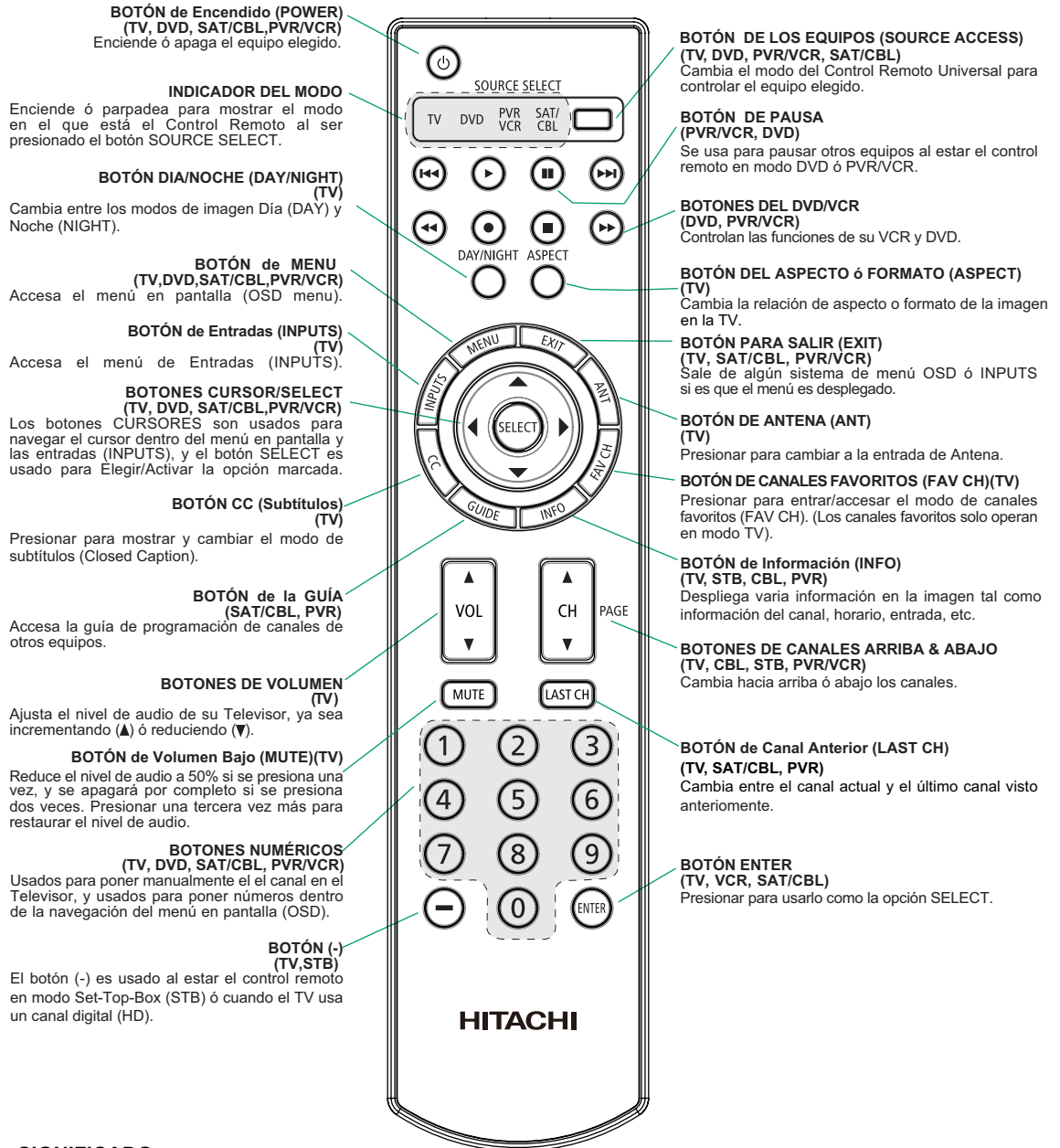

SIGNIFICADO

TV – Televisión **PVR** – Grabadora Personal de Video
CBL – Caja de Cable **DVD** – Reproductor de Disco Digital de Video (DVD)
SAT – Satélite **VCR** – Reproductor de Videocassete

NOTAS : 1. EL sensor de control remoto del TV está localizado en la parte inferior derecha de la pantalla. para controlar las funciones del TV, Apunte el control remoto directamente al sensor de control remoto para mejor resultado.

2. El código de la VCR está incluido en el modo de PVR.

Controles del Panel Lateral

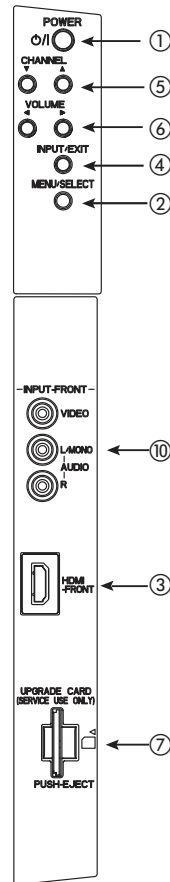
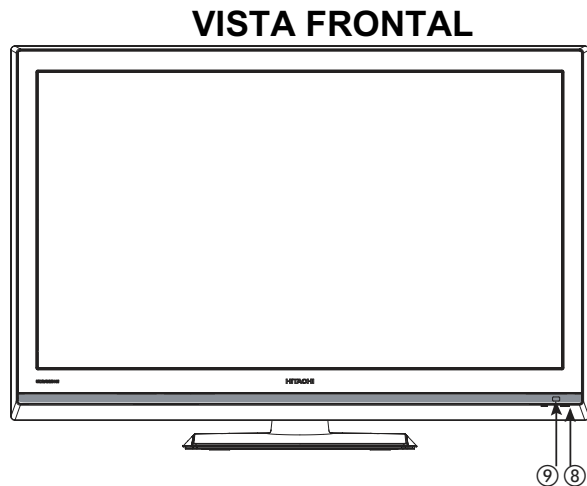

CONTROLES LATERALES

① Botón lateral de encendido (POWER)

Presionar este botón para encender ó apagar el televisor de LCD. También puede ser encendido ó apagado con el control remoto. La energía del TV solo se puede quitar desconectando la clavija. Luego de presionar este botón para encender el set, la función de este botón no estará disponible por un corto tiempo hasta que la imagen aparezca en la pantalla del Televisor.

NOTA: Al ser desconectado el Televisor, el reloj se detendrá y se puede restablecer eventualmente.

② Botón MENU/SELECT

Este botón permite entrar al MENU, haciendo posible configurar las opciones del Televisor a su preferencia sin usar el control remoto. Este botón también sirve como el botón SELECT al estar en modo de MENU.

③ HDMI-FRONT (Lateral)

Usar esta entrada HDMI para equipos externos como Set-Top-Boxes ó DVD equipados con conexión de salida HDMI (ver página 78 para referencia).

④ Botón de entradas y salir INPUT/EXIT

Presionar este botón para acceder a las entradas. Presionar de nuevo para salir del modo de MENU.

⑤ Selector de Canales

Presionar estos botones hasta que el canal deseado aparezca en la esquina superior derecha de la imagen. Estos botones también sirven como los cursores (▼) abajo y arriba (▲) al estar en el MENU.

⑥ Nivel de VOLUMEN

Presionar estos botones para ajustar el nivel de sonido. El nivel de volumen será desplegado en la imagen. Estos botones también sirven como los cursores (◀) izquierda y derecha (▶) al estar en el MENU.

⑦ Tarjeta de Actualización de Software (Upgrade Card)

Esta opción es para mejoras futuras de software. Hitachi le notificará si una actualización de software es requerida a su Televisor. Para poder recibir una notificación por escrito, favor de llenar y enviar la tarjeta de garantía.

Controles del Panel Frontal

⑧ Luz Indicadora de Encendido (POWER LED)

Para encender el Televisor, presionar el botón localizado en el lado derecho del Televisor de LCD. Una luz indicadora roja se encenderá en la esquina inferior derecha del marco del Televisor. El Televisor de LCD está listo para la operación del control remoto ON/OFF.

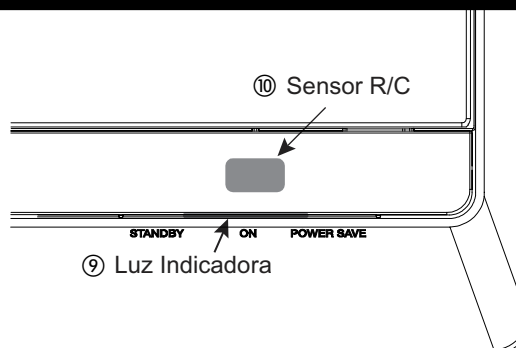

Luz Indicadora	Estado	Operación
Off	OFF.	El televisor está desconectado.
Enciende Rojo	OFF. (Stand-by)	El televisor está conectado listo para ser encendido.
Enciende Azul	On	Botón de encendido ON; se ve imagen.
Enciende Naranja	Off (Ahorro de energía)	Botón de encendido ON ; pero sin señal de entrada excepto antena (sin señal de sincronía).
Parpadea Azul	On	Al recibir la señal del Control remoto cada vez que se presione una tecla.

⑨ Sensor de CONTROL REMOTO (R/C)

Apuntar su control remoto en esta área al elegir canales, ajustando volumen, etc.

⑩ Terminales de Entrada Lateral (INPUT-FRONT)

Esta entrada provee terminales de video compuesto para conectar equipo con esta capacidad, tales como reproductores de DVD o Videocámaras.

NOTAS: 1. El Televisor de LCD HITACHI podrá aparentar estar apagado (Indicador Naranja) si no hay señal de entrada en **INPUT : 1, 2, 3, FRONT y HDMI 1,2 y FRONT**. Verificar la luz indicadora para asegurarse de que el TV está apagado ó está en modo de espera (Stand-by) (Indicador Rojo) al no estar en uso el Televisor.
2. El Control Remoto no puede encender o apagar la Alimentación Principal (CA) del Televisor.

Conexiones del Panel Posterior

Uso por primera vez

① Entrada de Antena

Para cambiar entre la señal Cable y Aérea, ir a la opción de Organizar Canales (Channel Manager) para cambiar el tipo de señal CABLE ó Aérea.

② Entradas de Audio/Video 1, 2 y 3

Al usar el botón INPUTS, los CURSORES (▲ y ▼), y el botón SELECT ó el CURSOR derecho ► del control remoto, se puede elegir cada entrada de video. Usar las entradas de audio y video para conectar equipos externos, tales VCRs, video cámaras, reproductores de DVD, etc. (Si tiene sonido monoaural, insertar el cable de audio en la terminal izquierda de audio).

③ Salida de MONITOR y Salida de Audio

Estas terminales proveen audio fijo, además señales de video (Cable/Aérea ó INPUTS) las cuales son usadas para grabación. Usar la salida S-Video para una mejor calidad de video. Señal de componente en las entradas 2 y 3, y las entradas HDMI no tendrán salida de monitor.

④ Salida óptica (Audio Digital)

Esta terminal provee Salida de Audio Digital para su equipo de audio que es compatible con Dolby® Digital y PCM, tal como un amplificador de audio.

NOTA: *Fabricado bajo licencia de Dolby Laboratories. "Dolby" y el símbolo doble-D son marcas registradas de Dolby Laboratories.

⑤ Entrada S-VIDEO 1

La entrada 1 provee una terminal S-VIDEO (Super Video) para conectar equipo con capacidad de salida S-VIDEO.

NOTA: 1. Se pueden usar las entradas VIDEO ó S-VIDEO para conectar en INPUT 1, pero solo una de estas entradas puede usarse a la vez.
2. La salida S-VIDEO puede usarse para grabación, solo cuando la entrada es del tipo S-VIDEO.

⑥ Entradas HDMI 1, 2 (High Definition Multimedia Interface)

Acerca del HDMI – HDMI es la **HDMI** HIGH-DEFINITION MULTIMEDIA INTERFACE nueva-generación de interface digital para equipos electrónicos. El **HDMI** permite la segura distribución de video de alta definición sin comprimir y múltiples canales de audio en un solo cable. Porque las señales digitales de TV (DTV) permanecen en formato digital, el **HDMI** asegura que las imagenes de alta-definición mantengan la mas alta calidad de video desde un equipo a la pantalla de su Televisor.

Usar la entrada **HDMI** para conectar equipos externos tales como Set-Top-Boxes ó reproductores de DVD equipados con conexión de salida **HDMI**.

HDMI, el logotipo **HDMI** y el nombre *High-Definition Multimedia Interface* son marcas registradas de la compañía **HDMI** Licensing LLC.

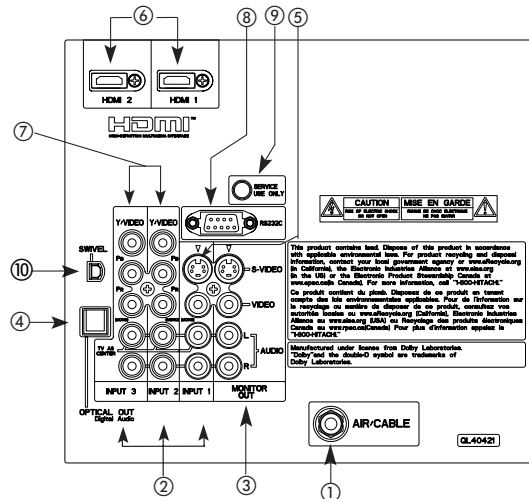

NOTA: 1. La entrada HDMI no esta diseñada para usarse con computadoras personales.
2. Solo formatos DTV tales como 1080p, 1080i, 720p, 480i y 480p están disponibles para la entrada HDMI.

⑦ Entrada por Componente: Y-PBPR Inputs

Las entradas 2 y 3 proveen terminales Y-PBPR para conectar equipos con esta capacidad, tales como reproductores de DVD ó Set Top Box. Se puede usar señal de video compuesto para ambas entradas.

NOTA: 1. No conectar VIDEO compuesto y S-VIDEO en la entrada INPUT 1 al mismo tiempo. S-VIDEO tiene prioridad sobre la entrada de VIDEO.
2. Las salidas por componente de su equipo pueden llamarse Y, B-Y, y R-Y. En este caso, conectar la salida por componente B-Y a la entrada P_B del TV y la salida por componente R-Y a la entrada P_R del televisor.
3. Las salidas por componente de su equipo pueden llamarse Y-CbCr. En este caso, conectar la salida por componente C_b a la entrada P_B del TV y la salida por componente C_r a la entrada P_R.
4. Puede ser necesario ajustar el TINTE para obtener una óptima calidad de imagen al usar las entradas Y-PbPr (ver pag. 100).
5. Para evitar faltas sobre el derecho de autor, la salida MONITOR OUT será anormal, al usar las terminales Y-PbPr y la entrada HDMI.
6. La entradas 2 y 3 (Y-VIDEO) pueden ser usadas para video compuesto y entrada de video por componente.

⑧ Para control Especial de AV solamente.

⑨ Para uso en la fábrica solamente.

⑩ Para Cable de Base Giratoria (Swivel)

Conecte el cable para la base giratoria de aquí al conector localizado en la base giratoria (incluida).

Conectando Equipos de Video Externos

Las entradas en el panel LATERAL se proveen para su conveniencia permitiendole la fácil conexión de señales HDMI o DVI de un DVD, Set Top Box y Video Juego como se muestra en los siguientes ejemplos: (Al conectar señales DVI será necesario conectar la salida de audio a las entradas de audio LATERALES del Televisor) :

A) Conectando señal HDMI.

CONTROLES DEL PANEL LATERAL

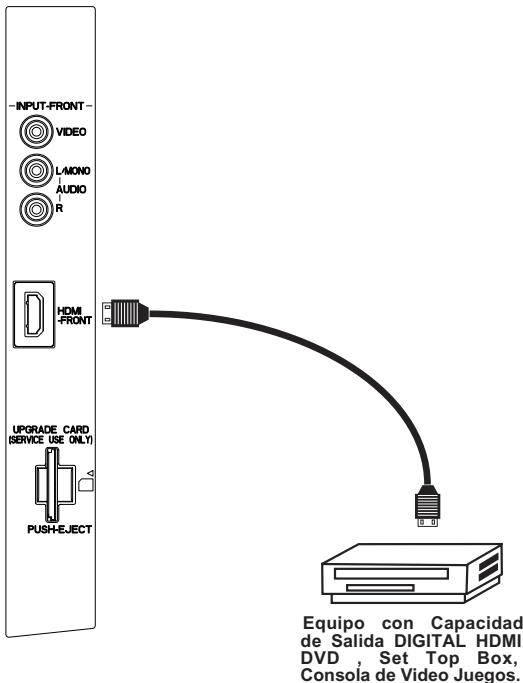

Nota : Cables especiales de los equipos serán de acuerdo a las especificaciones del equipo.

B) Conectando señal DVI.

CONTROLES DEL PANEL LATERAL

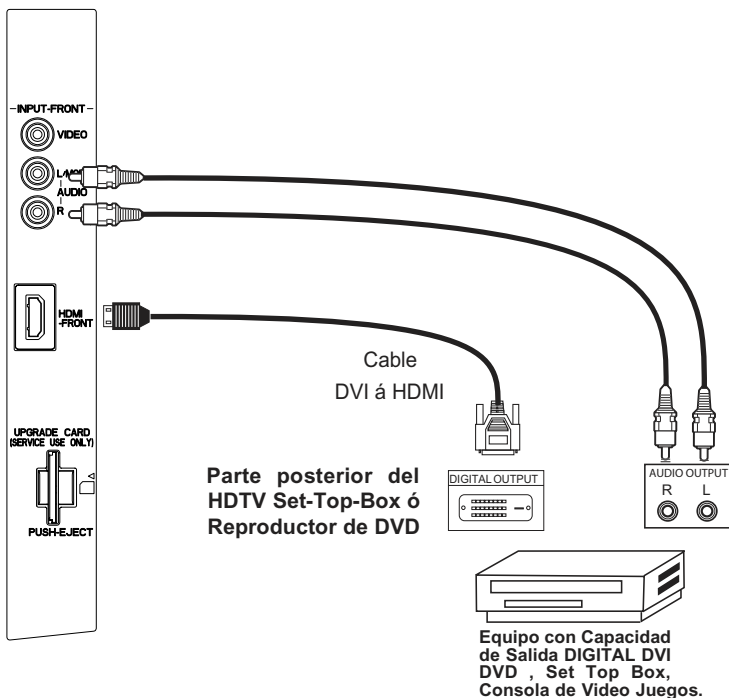

Nota : Cables especiales de los equipos serán de acuerdo a las especificaciones del equipo.

NOTA: Inserte completamente los conectores cuando conecte las entradas del panel lateral. De no hacerlo, la imagen desplegada puede ser anormal.

Conectando Equipos de Video Externos

Las terminales Laterales se proveen para su conveniencia permitiendole la fácil conexión de una Cámara de Video, un DVD, Video Juego, VCR y una Cámara Digital como se muestra en los siguientes ejemplos:

CONTROLES DEL PANEL LATERAL

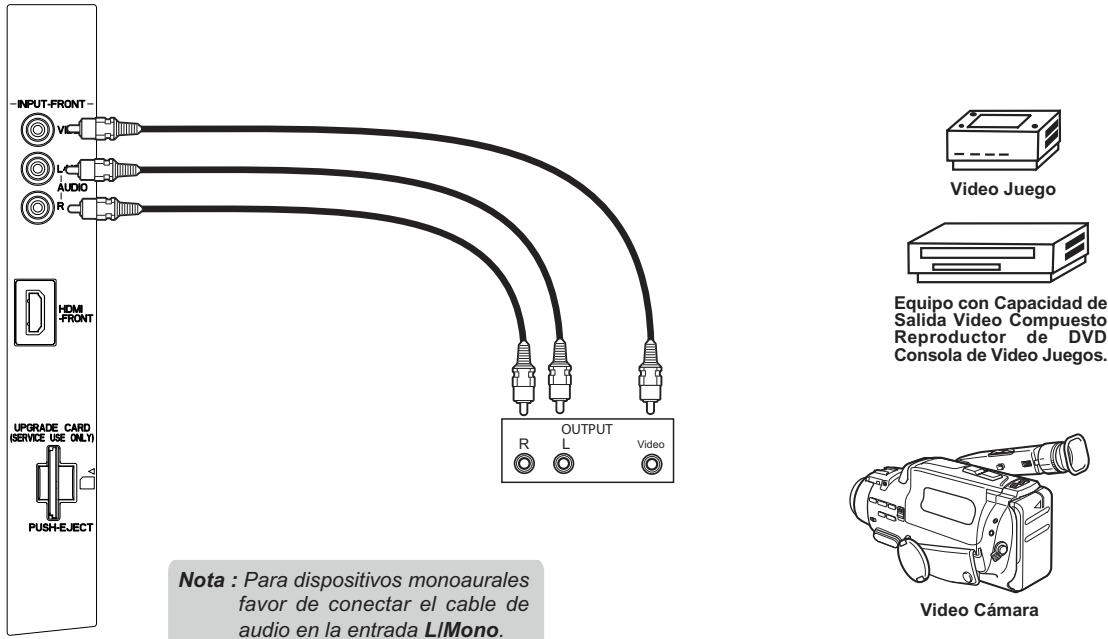

Nota : Para dispositivos monoaurales favor de conectar el cable de audio en la entrada **LIMono**.

Nota : Los cables especiales de los equipos deben ser de acuerdo a las especificaciones del equipo.

NOTA: Inserte completamente los conectores cuando conecte las entradas del panel lateral. De no hacerlo, la imagen desplegada puede ser anormal.

El acomodo exacto que usted use para conectar el VCR, videocámara, reproductor de discos láser, DVD o Set Top Box HDTV para su televisión depende del modelo y funciones de cada componente. Revise el manual operativo de cada componente para la ubicación de entradas y salidas de audio y video.

Los siguientes diagramas de conexión se ofrecen como sugerencia. Sin embargo, usted tal vez tenga que modificarlos para ajustarse a su combinación particular de componentes y funciones. Para mejor desempeño, los cables de video y audio deben ser coaxiales y blindados.

Antes de Operar Equipos Externos de Video

Conecte un equipo externo a la terminal de ENTRADA, después presione el botón INPUTS para mostrar el Menú de ENTRADAS. Use los CURSORES (▲ y ▼) para seleccionar la Entrada de su preferencia. Entonces presione el botón SELECT o el CURSOR ► para confirmar su elección (ver pag. 89).

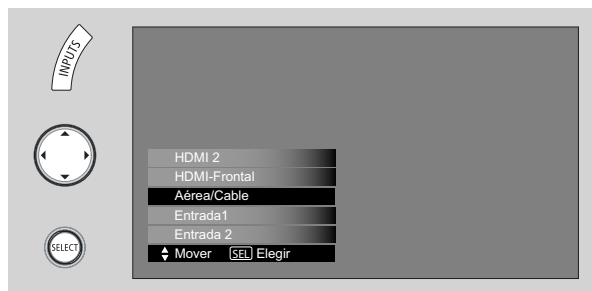

Conexiones del Panel Posterior

Uso por primera vez

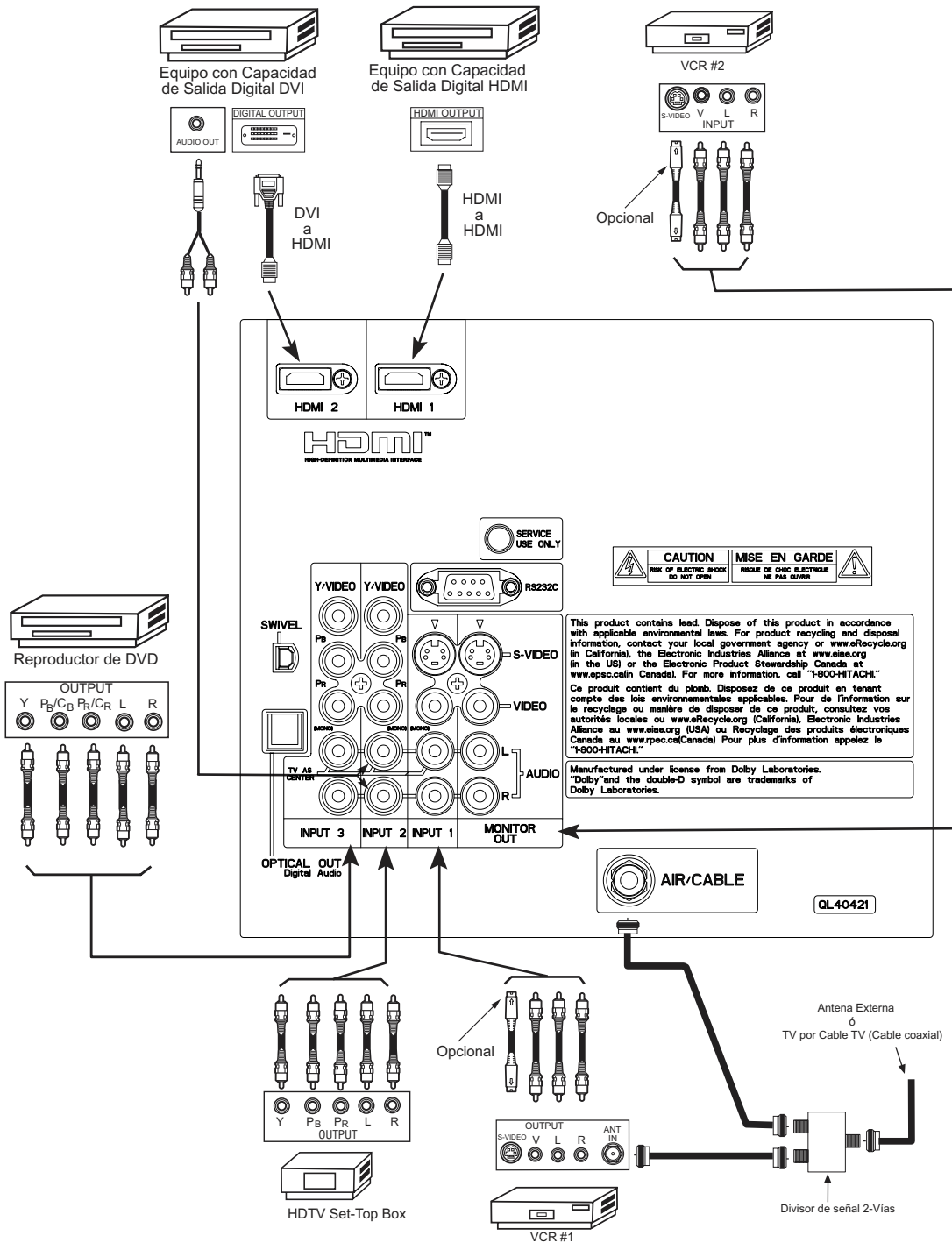

NOTA: Los Cables son opcionales, excepto cuando se especifica.

Consejos sobre las Conexiones del Panel Posterior

- Las conexiones S-VIDEO, Y-PBPR, ó HDMI se proveen para equipos de alta fidelidad tales como DVD's, VCR's etc. que cuenten con esta opción. Use estas conexiones en lugar de una conexión de video estándar si su dispositivo cuenta con esta opción.
- Si su dispositivo tiene solamente una salida de audio (monoaural), conéctelo al canal izquierdo(L/MONO) en el panel posterior de la televisión.
- Consulte el manual de operación de sus otros equipos electrónicos para información adicional sobre como instalar sus cables de entrada/salida.
- Una sola VCR puede ser usada para VCR #1 y VCR #2, pero recuerde que un VCR no puede grabar su propio video o línea de salida (INPUT: 1 en el ejemplo de la página 80). Consulte la guía de operación de su VCR para más información en las conexiones de entrada y salida.
- Conecte solamente 1 equipo (VCR, Reproductor de DVD, videocámara, etc.) a cada terminal de entrada.
- Las conexiones por COMPONENTE Y-PBPR (ENTRADAS 2 y 3) se proveen para equipos de alta fidelidad tales como DVD's y Set Top Box's. Use estas conexiones en lugar de una conexión de video estándar si su dispositivo tiene esta opción
- Las salidas por componente de su equipo pueden llamarse Y, B-Y, and R-Y. En este caso, conectar la salida por componente B-Y a la entrada PB del TV y la salida por componente R-Y a la entrada PR del televisor.
- Las salidas por componente de su equipo pueden llamarse Y, CBCR. En este caso, conectar la salida por componente CB a la entrada PB del TV y la salida por componente CR a la entrada PR del televisor.
- Puede ser necesario ajustar el TINTE para obtener una óptima calidad de imagen al usar la entradas Y-PBPR (ver página 100).
- Para asegurarse de no infringir las leyes sobre derechos de autor, la Salida de Monitor será anormal, cuando se usen las entradas Y-PBPR y las entradas HDMI.
- Las entradas HDMI 1, HDMI 2 ó HDMI FRONTAL pueden recibir señales de HDMI.
- La Salida de Monitor S-VIDEO puede ser usada para grabar unicamente cuando la entrada sea S-VIDEO.
- Al usar la entrada HDMI desde un Set-Top-Box, se recomienda usar una señal de entrada 1080p, 1080i o 720p.
- Al conectar una señal de 1080p por HDMI se recomienda que la longitud del cable de HDMI sea menor de 5 metros.

RECOMENDACIONES PARA LA INSTALACIÓN:

1. *Las Señales de Video que pasan a través de una VCR pudieran ser afectadas por el sistema de proteccion de derechos de autor y la imagen aparecerá distorsionada en la televisión.*
2. *Al conectar la televisión directamente a las salidas de Audio/Video de un Set-Top-Box se asegura una mejor calidad de imagen.*

Conectando Equipos de Video Externos

CONECTANDO UNA FUENTE DE VIDEO Y AUDIO ESTEREO A LAS ENTRADAS 1 ~ FRONTAL

1. Conecte el cable de la salida de video (VIDEO OUT) del VCR o del Reproductor de Laserdisc a la entrada de video (VIDEO/Y) como se muestra en el Panel Posterior.
2. Conecte el cable de la salida de audio derecha (AUDIO OUT R) del VCR o Reproductor de Laserdisc a la entrada de audio derecha (AUDIO/R).
3. Conecte el cable de la salida de audio izquierda (AUDIO OUT L) del VCR o Reproductor de Laserdisc a la entrada de audio izquierda (AUDIO/L).
4. Presione el botón INPUTS, entonces seleccione la ENTRADA 1~ FRONTAL del Menú de Entradas para ver el programa de su VCR o Reproductor de Laserdisc.
5. Seleccione la señal CABLE o AEREA en el Menú de Entradas o presione el botón ANT en el control remoto para regresar al último canal sintonizado.

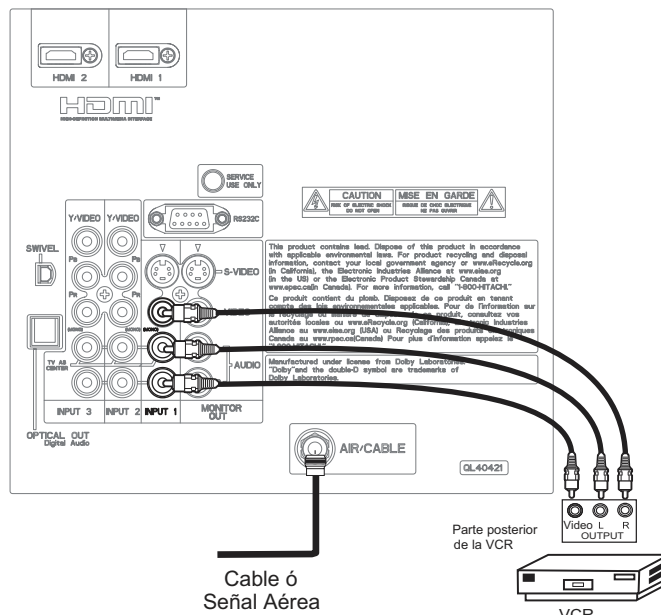

- NOTA:**
1. Inserte completamente los conectores al hacer las conexiones del panel posterior. La imagen y el sonido que se está reproduciendo será anormal si la conexión está floja.
 2. Una sola VCR puede ser usada para VCR #1 y VCR #2, (ver página 80) pero recuerde que una VCR no puede grabar su propio video o línea de salida. Consulte la guía de operación de su VCR para más información en las conexiones de entrada y salida.
 3. Cuando se usen las ENTRADAS 2 ó 3, es necesario conectar la salida de video del dispositivo a la terminal de entrada Y/VIDEO del Televisor.

CONECTANDO SEÑAL S-VIDEO Y AUDIO ESTEREO DE UN EQUIPO A LA ENTRADA (INPUT 1)

1. Conecte el cable de la salida de video S-VIDEO del VCR S-VHS o Reproductor de Laserdisc a la entrada S-VIDEO de la TV, como se muestra en el Panel Posterior .
2. Conecte el cable de la salida de audio derecha (AUDIO OUT R) del VCR o Reproductor de Laserdisc a la entrada de audio derecha (AUDIO/R)
3. Conecte el cable de la salida de audio izquierda (AUDIO OUT L) del VCR o Reproductor de Laserdisc a la entrada de audio izquierda (AUDIO/L)
4. Presione el botón INPUTS, entonces seleccione la ENTRADA 1 del Menú de Entradas para ver el programa de su VCR o Reproductor de Laserdisc.
5. Seleccione CABLE o AÉREA en el Menú de Entradas o presione el botón ANT en el control remoto para regresar al último canal sintonizado.

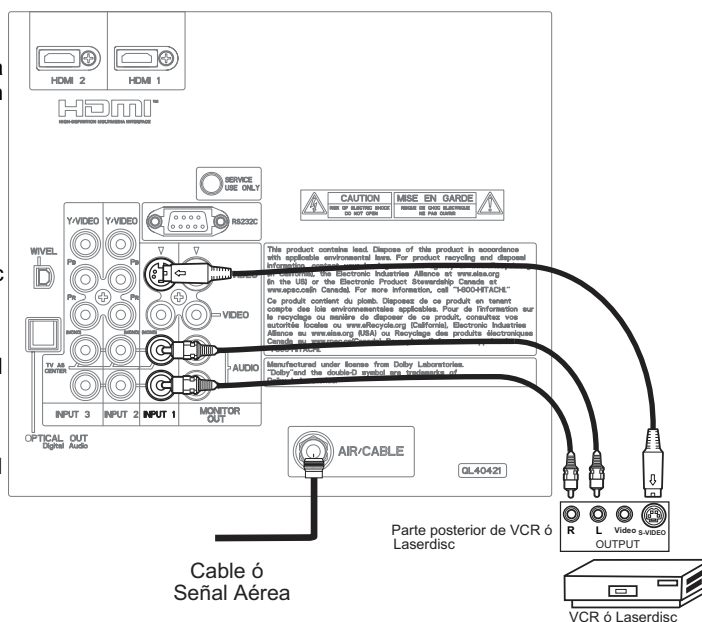

- NOTA :**
1. Inserte completamente los conectores al hacer las conexiones del panel posterior. La imagen y el sonido que se esta reproduciendo será anormal si la conexión está floja.
 2. Un solo VCR puede ser usado para VCR #1 y VCR #2, (ver página 80) pero recuerde que un VCR no puede grabar su propio video o línea de salida. Consulte la guía de operación de su VCR para más información en las conexiones de entrada y salida.

Conectando Equipos de Video Externos

CONECTANDO UN EQUIPO CON SALIDA HDMI O DVI A LAS ENTRADAS HDMI 1, 2 Ó FRONTAL

1. Conecte el conector HDMI o el adaptador DVI/HDMI de la salida del Set Top Box HDTV o Reproductor de DVD a la entrada HDMI tal como se muestra en la parte de abajo.
2. Al usar salida DVI, conecte el cable de la salida de audio derecha(AUDIO OUT R) del Set Top Box HDTV o DVD a la entrada derecha(AUDIO IN/R) tal como se muestra en la parte de abajo.
3. Al usar salida DVI, conecte el cable de la salida de audio izquierda(AUDIO OUT L) del Set Top Box HDTV o DVD a la entrada izquierda(AUDIO IN/L) tal como se muestra en la parte de abajo.
4. Presione el botón INPUTS, entonces seleccione HDMI 1, HDMI 2 o HDMI-FRONTAL para ver el programa del Set Top Box HDTV o el Reproductor de DVD.
5. Seleccione CABLE o AÉREA en el Menú de Entradas o presione el botón ANT en el control remoto para regresar al último canal sintonizado.

- NOTA:1.** Inserte completamente los conectores al hacer las conexiones del panel posterior. La imagen y el sonido que se esta reproduciendo será anormal si la conexión está floja.
- 2.** Las entradas HDMI en HDMI 1, HDMI 2 y HDMI-FRONTAL contienen el sistema de protección contra copiado llamado High-bandwidth Digital Content Protection(HDCP). El HDCP es un sistema que codifica las señales de video cuando se usan conexiones HDMI, para prevenir el copiado ilegal de la información de video.
- 3.** HDMI no es una tecnología de "RED", establece una conexión punto-a-punto en un solo sentido para la entrega de video no comprimido en una pantalla.
- 4.** El dispositivo digital conectado controla la interface HDMI, por lo tanto la configuración adecuada de las opciones de usuario del equipo determinan la resolución final del video.
- 5.** Al usar un adaptador DVI a HDMI, conecte los cables de salida de audio Audio Out L y R a la misma HDMI (1, 2 ó FRONTAL) que conectó el cable HDMI. (Para HDMI-FRONTAL favor de consultar la página 78).

Entrada HDMI

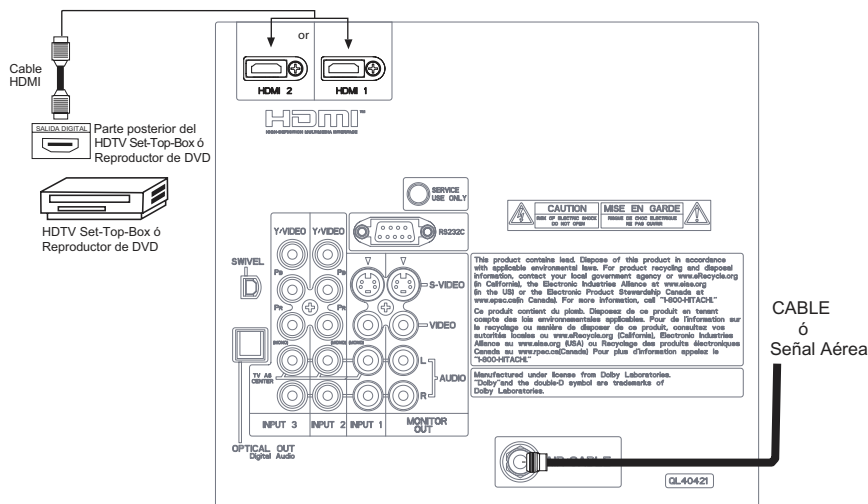

Entrada DVI a HDMI

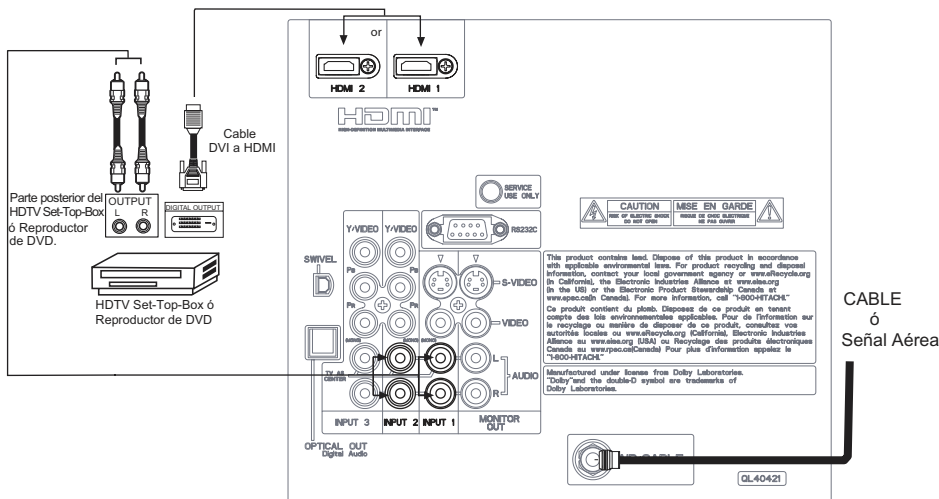

Conectando Equipos de Video Externos

CONECTANDO UN EQUIPO CON SALIDA DE COMPONENTE Y DE AUDIO EN LAS ENTRADAS 2 ó 3 : Y-PbPr.

1. Conecte el cable de la salida Y del reproductor Laserdisc/Reproductor de DVD ó HDTV set top box a la entrada (Y), como se muestra en el panel posterior de la figura.
2. Conecte el cable de la salida PB/CB ó B-Y del Laserdisc/Reproductor de DVD ó HDTV set top box a la entrada PB del TV.
3. Conecte el cable de la salida PR/CR ó R-Y OUT del Laserdisc/Reproductor DVD ó HDTV set top box a la entrada PR del TV.
4. Conecte el cable de la salida de audio derecha (AUDIO OUT R) del Set Top Box HDTV o DVD a la entrada de audio derecha(AUDIO/R).
5. Conecte el cable de la salida de audio izquierda (AUDIO OUT L) del Set Top Box HDTV o DVD a la entrada de audio izquierda(AUDIO/L).
6. Presione el botón INPUTS, entonces seleccione la ENTRADA 2 ó 3 del Menú de Entradas para para ver el programa del Set Top Box HDTV o el Reproductor de DVD/Laserdisc.
7. Seleccione CABLE ó AÉREA en el Menú de Entradas o presione el botón ANT en el control remoto para regresar al último canal sintonizado.

NOTA: 1. Inserte completamente los conectores al hacer las conexiones del panel posterior.
La imagen y el sonido que se está reproduciendo será anormal si la conexión está floja.

2. Ver pág. 81 para sugerencias sobre las **CONEXIONES DEL PANEL POSTERIOR.**

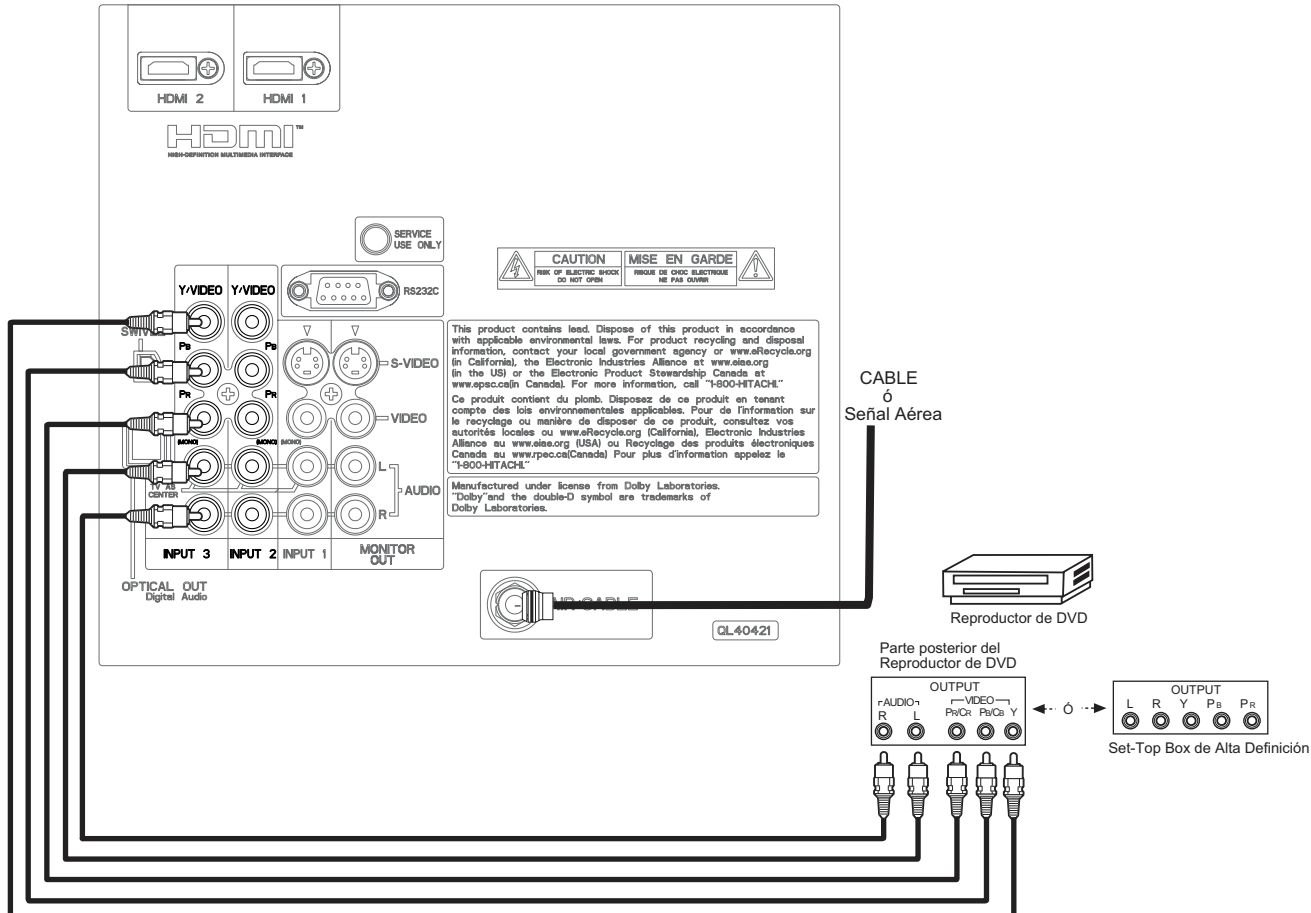

Conectando Equipos de Video Externos

CONECTANDO UN EQUIPO DE VIDEO Y AUDIO MONAURAL A LAS ENTRADAS 1, 2, 3 ó FRONTAL

1. Conectar el cable de la salida de video(VIDEO OUT) del VCR o del Reproductor de DVD a la entrada de video(VIDEO/Y) como se muestra en el Panel Posterior de la derecha.
2. Conectar el cable de la salida de audio(AUDIO OUT) de su VCR o Reproductor de DVD a la entrada (MONO)/AUDIO IN L) de su TV .
3. Presione el botón INPUTS, entonces seleccione la ENTRADA 1,2,3 ó Frontal del Menú de Entradas para ver el programa de su VCR o Reproductor DVD.
4. Seleccione CABLE o AÉREA en el Menú de Entradas o presione el botón ANT en el control remoto para regresar al último canal sintonizado. (Para la **ENTRADA FRONTAL** consultar la página 79).

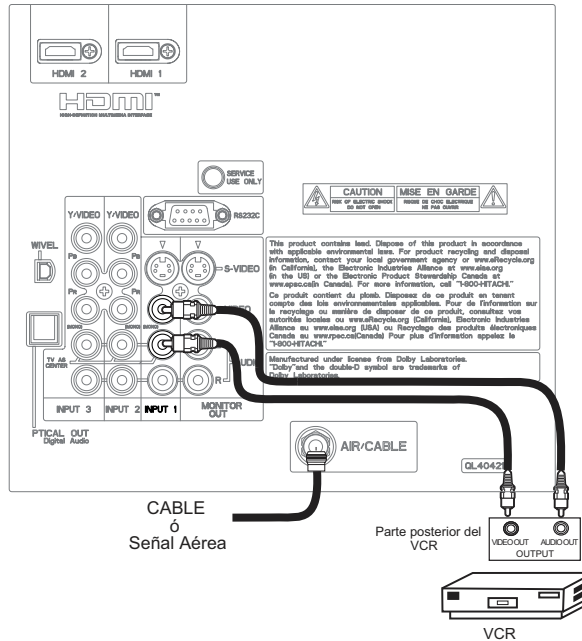

CONECTANDO UN AMPLIFICADOR DE AUDIO EXTERNO

Para controlar el nivel de audio del TV de LCD con un amplificador externo de audio, conectar el sistema como se muestra en la derecha. La salida "OPTICAL OUT" del panel posterior es una salida fija. El Volumen del amplificador es controlado por el amplificador, no por el televisor de LCD. La terminal OPTICAL OUT se puede conectar a todo equipo con Entrada Óptica.

1. Conectar un cable óptico desde la salida Optical out a la entrada Óptica de un sistema de sonido ó Amplificador como se muestra en el Panel posterior como la figura de la derecha.

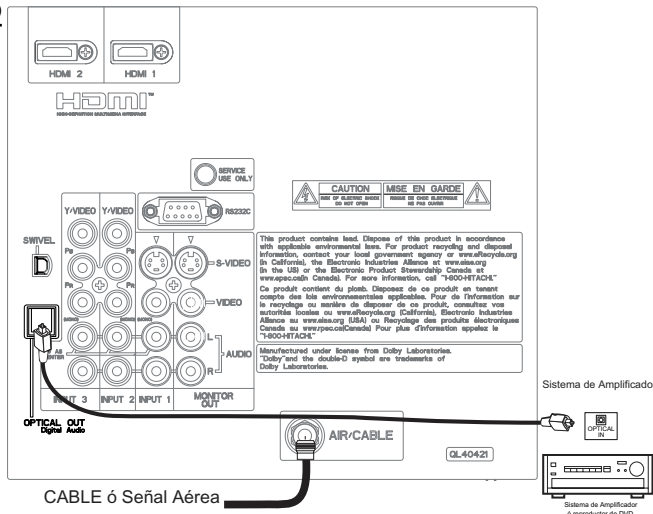

CONEXIÓN DE LA SALIDA DE MONITOR

La Salida de Monitor (Monitor Out) proporciona audio y video de las señales CABLE/AÉREA y las Entradas 1, 2, 3, y Frontal. No proporciona Video por Componente ó HDMI.

1. Conexión de S-Video:
Conectar el cable de la salida S-VIDEO del Panel Posterior a la entrada S-VIDEO del VCR.

Conexión de Video:
Conectar el cable de la salida VIDEO del Panel Posterior a la entrada VIDEO del VCR.

2. Conectar el cable de la entrada AUDIO IN R del VCR a la salida AUDIO/R del Panel Posterior del Televisor.
3. Conectar el cable de la entrada AUDIO IN L del VCR a la salida AUDIO/L del Panel Posterior del Televisor.

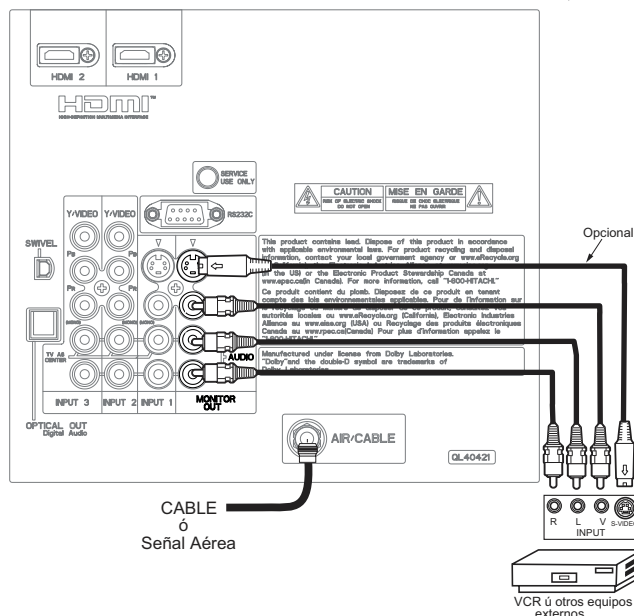

NOTA: Al hacer conexiones de video, conectar solo S-Video ó solo Video. Si ambas son conectadas, el S-Video tiene prioridad.

El Control Remoto

Además de controlar todas las funciones de su TV LCD **Hitachi**, el nuevo control remoto está diseñado para operar diferentes tipos de VCRs, receptores de cable, receptores satelitales, reproductores DVD, y otros equipos de audio/video con solo apretar un botón. Todas las teclas de operación básicas están agrupadas en una sola área.

Para operar su TV LCD, seleccione **TV** presionando el botón Source del Source Select en el remoto. El indicador del modo **TV** parpadeará, indicando que el control remoto está listo para operar su televisor.

Para operar su VCR/PVR (Grabadora de Video Personal), seleccione **PVR/VCR** presionando el botón Source del Source Select en el remoto. El indicador del modo **PVR/VCR** parpadeará, indicando que el control remoto está listo para operar su VCR/PVR. (Vea las instrucciones en la pág. 94 para programar el control remoto y operar su VCR/PVR).

Para operar su receptor de cable, seleccione **SAT/CBL** presionando el botón Source del Source Select en el remoto. El indicador del modo **SAT/CBL** parpadeará, indicando que el control remoto está listo para operar su receptor de cable. (Vea las instrucciones en la pág. 91 para programar el control remoto y operar su receptor de cable).

Para operar su STB (Set-top-box) o receptor satelital, seleccione **SAT/CBL** presionando el botón Source del Source Select en el remoto. El indicador del modo **SAT/CBL** parpadeará, indicando que el control remoto está listo para operar su STB. Si usted tiene un receptor satelital, use también este botón para programar su receptor satelital. (Vea las instrucciones en la pág. 92 para programar el control remoto y operar su STB o receptor satelital).

Para operar su reproductor DVD, seleccione **DVD** presionando el botón Source del Source Select en el remoto. El indicador del modo **DVD** parpadeará, indicando que el control remoto está listo para operar su reproductor DVD. (Vea las instrucciones en la pág. 93 para programar el control remoto y operar su reproductor DVD).

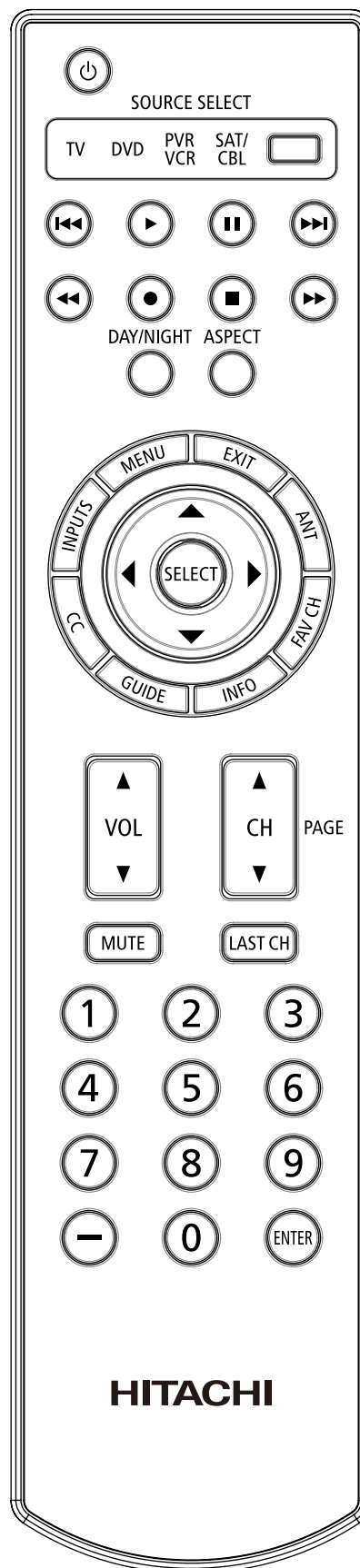

Como Utilizar el Control Remoto de su TV

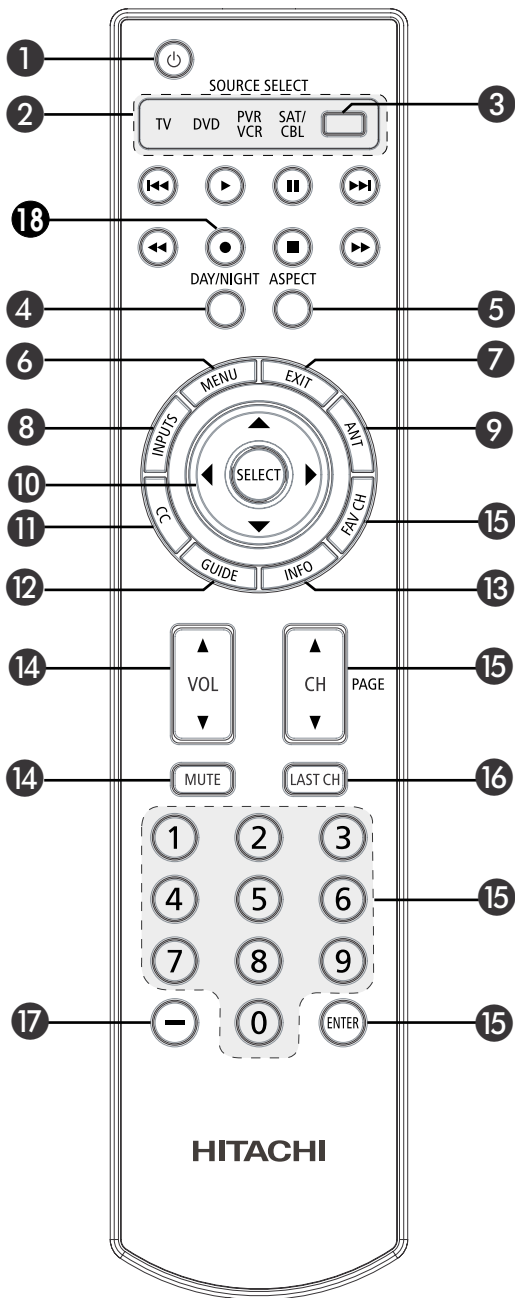

1 Botón de encendido/apagado (POWER)

Presione este botón para encender o apagar el televisor cuando el remoto este en modo **TV**. (Ver página 86 para las instrucciones de como programar el control remoto en modo **TV**).

2 Indicadores de MODO

Enciende o parpadea tres veces para mostrar el modo del control remoto.

3 Botón SOURCE SELECT

Presione este botón para seleccionar el modo del control remoto.

4 Botón DIA/NOCHE (DAY/NIGHT)

Presione este botón para cambiar entre las configuraciones de modo de imagen **Día(Normal)**, **Día(Dinámico)** y **Noche**. Seleccione los modos de **Día** para ver durante el día con mayor brillo y contraste para competir con la luz interior del cuarto. Seleccione **Noche** para ver durante la noche con menor brillo y contraste para una imagen más detallada (ver pág. 100 para cambiar la configuración).

NOTA: Para la configuración automática del modo de imagen **DIAINOCHE**, ver pág. 114.

Como Utilizar el Control Remoto de su TV

5 Botón de ASPECTO (ASPECT)

Presione este botón para cambiar rápidamente la relación de aspecto del formato de la imagen. Dependiendo del formato de la señal de entrada recibida, la relación de aspecto del formato de imagen le permite a usted ajustar las imágenes a través de las siguientes opciones:

4:3 ESTÁNDAR

Use este modo de aspecto para desplegar imágenes (4:3) convencionales. Se colocan paneles laterales (áreas grises) en la izquierda y derecha de la imagen para conservar la relación de aspecto original de la fuente.

4:3 EXPANDIDO

Use este modo de aspecto para desplegar imágenes (4:3) convencionales incrementando linealmente la expansión de la imagen del centro hacia las orillas del área de despliegue con el propósito de llenarla.

4:3 ZOOM1/ZOOM2

Use estos modos de aspecto para aumentar las imágenes de fuentes (4:3) convencionales.

16:9 ESTÁNDAR 1

Use este modo de aspecto para desplegar fuentes 16:9 como HDTV y DVD's conservando la relación de aspecto original 16:9 mostrando el 95% del tamaño.

16:9 ESTÁNDAR 2

Use este modo de aspecto para desplegar fuentes 16:9 como HDTV y DVD's conservando la relación de aspecto original 16:9 mostrando el 100% del tamaño.

16:9 ZOOM

Use este modo para aumentar la imagen en el aspecto 16:9.

- Canal de Antena-Analógica
- Entrada S-Video/Video (Formato Automático: Off)
- Entrada HDMI- 480i/480p (Formato Automático: Off)
- Entrada Componente- 480i/480p (Formato Automático: Off)

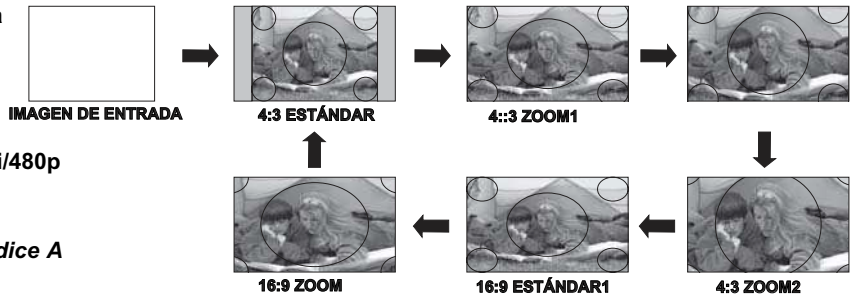

Nota : Favor de ver el apéndice A en la página 138-139.

- Canal de Antena-Digital (4:3)
- S-Video/Video 4:3/Entrada Letter (Formato Automático: On)
- HDMI-480i/480p 4:3/Entrada Letter (Formato Automático: On)
- Componente-480i/480p 4:3/Entrada Letter (Formato Automático: On)

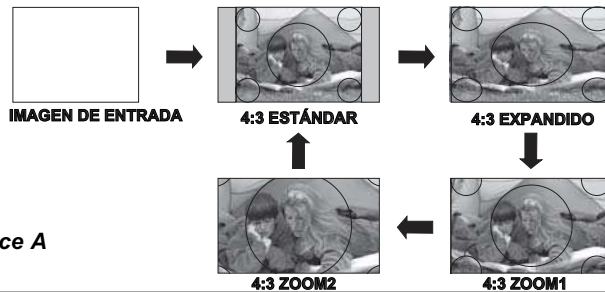

Nota : Favor de ver el apéndice A en la página 138-139.

- Entrada S-Video/Video 16:9 (Formato Automático: On)
- Entrada 16:9 HDMI- 480i/480p (Formato Automático: On)
- Entrada 16:9 Componente- 480i/480p (Formato Automático: On)



Nota : Favor de ver el apéndice A en la página 138-139.

- Canal de Antena-Digital (16:9)
- Entrada HDMI- 720p/1080i/1080p
- Entrada Componente-720p/1080i

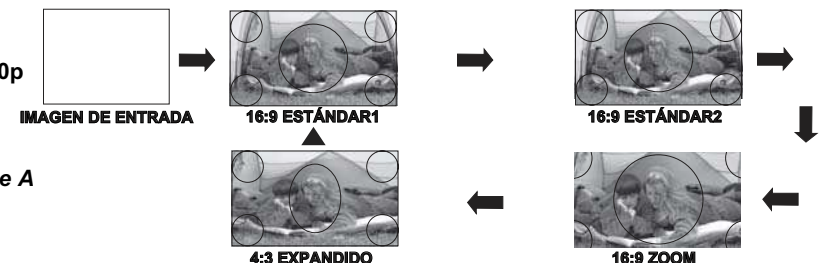

Nota : Favor de ver el apéndice A en la página 138-139.

NOTA: 1. El modo de Aspecto en todas las entradas de video tienen configuración independiente.
 2. Los ajustes de Posición Vertical están disponibles directamente cuando usted elige los modos de aspecto 4:3 EXPANDIDO/ZOOM1/ZOOM2 ó 16:9 ZOOM (ver también pág.102).
 3. Cuando se despliegue el modo 16:9 ESTÁNDAR 2, pueden aparecer líneas en las orillas de la imagen, considere que esto es una operación normal del televisor.

Como Utilizar el Control Remoto de su TV

6 Botón MENU

El botón MENU desplegará el Menú en Pantalla.

7 Botón EXIT

Este botón lo sacará de todos los menús en pantalla.

8 Botón de entradas (INPUTS)

Cuando el control remoto está en el modo TV, presione este botón para acceder al menú de **ENTRADAS**. Use los **CURSORES** y el botón **SELECT** para elegir las entradas que están siendo usadas. El presionar repetidamente el botón de **ENTRADAS** lo llevará a través de todas las opciones del menú de entradas. Luego presione el botón **SELECT** para seleccionar.



ENTRADA1	Seleccione para ir a la Entrada 1.
ENTRADA2	Seleccione para ir a la Entrada 2.
ENTRADA3	Seleccione para ir a la Entrada 3.
ENTRADA-FRONTAL	Seleccione para ir a la Entrada Lateral.
HDMI1	Seleccione para ir a la entrada HDMI 1.
HDMI2	Seleccione para ir a la entrada HDMI 2.
HDMI-FRONTAL	Seleccione para ir a la entrada HDMI Lateral.
AEREA/CABLE	Seleccione entre la señal Aérea o de Cable.

9 Botón de Antena (ANT)

Utilice este botón para acceder directamente a la entrada de señal Aérea o de Cable.

10 Botones CURSOR/SELECT

Todas las funciones del Menú en pantalla pueden ser configurados o ajustados utilizando los **CURSORES**, excepto los valores numéricos. Los **CURSORES** resaltarán, ajustarán y configurarán diversas funciones. Presione el **CURSOR** de la dirección deseada y presione el botón **SELECT** para seleccionar o elegir.

11 Botón de Subtítulos (Closed Captions-CC)

Presione este botón para desplegar los subtítulos en la pantalla cuando estén disponibles por el programa de TV. En Canales Analógicos, presione el botón **CC** una y otra vez, para ir a través de los modos de Subtítulos y para desactivar los Subtítulos.

12 Botón de GUIA (GUIDE)

[Solo modos Receptor de Cable (CBL), receptor satelital (SAT)/Set-Top-Box (STB)]

Presione este botón para acceder la Guía de Canales del cable (CBL) y receptor satelital o alta definición (SAT/STB) en el modo (CBL)(SAT/STB).

13 Botón INFO

Presione este botón cuando usted desee consultar el canal recibido, el origen o fuente de la imagen, si el canal tiene estereo (ST) o programa secundario de audio (SAP), la hora, el nombre del canal o si el tiempo de auto apagado está activado.

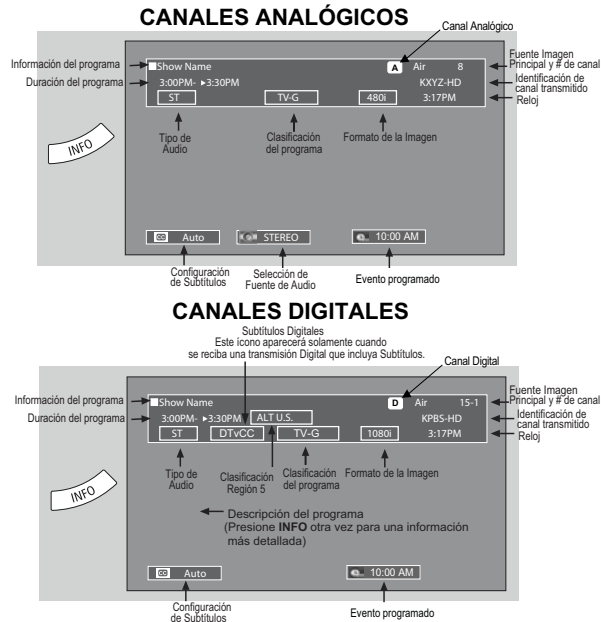

Cuando se conecta una señal S-VIDEO a la ENTRADA 1

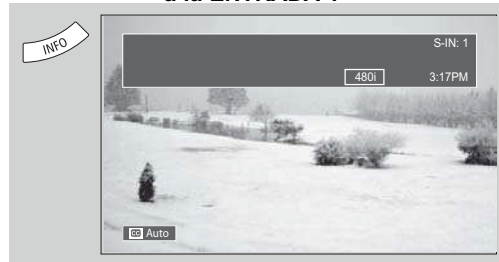

Cuando se conecta Video Componente: Señal Y-PbPr conectada a la ENTRADA 3

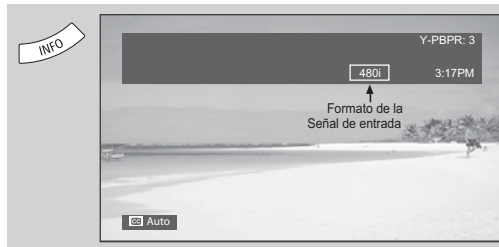

NOTA: 1. Presionar el botón **INFO** otra vez ó el botón **EXIT** pare regresar a la imagen normal.

2. La configuración del Aspecto no será mostrada si el canal está bloqueado.

Como Utilizar el Control Remoto de su TV

14 Botón de VOLUMEN (VOL), Botón MUTE

Use el botón **VOL UP** (▲) or **VOL DOWN** (▼) hasta obtener el nivel de sonido deseado.

Para reducir el sonido a la mitad del volumen normal (**SOFT MUTE**) para contestar el teléfono, etc., presione el botón **MUTE**. Presione el botón **MUTE** un vez más para apagar el sonido completamente (**MUTE**). Para encender el sonido, presione el botón **MUTE** una vez más o el botón **VOL UP** (▲).

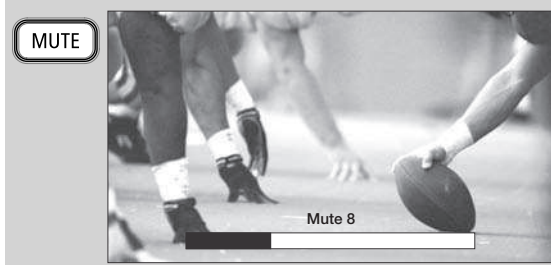
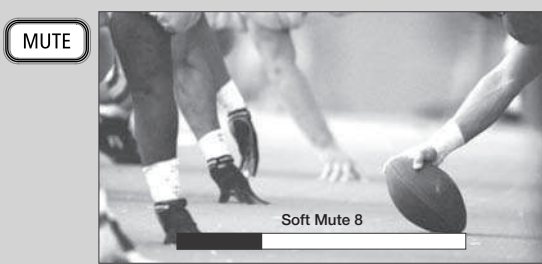
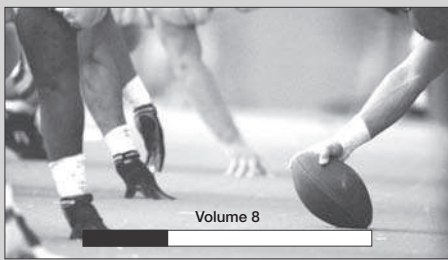

Los **Subtítulos** serán desplegados automáticamente cuando las funciones **MUTE/SOFT MUTE** estén activas y los **Subtítulos** estén en modo **AUTO** (ver pág. 119).

Cuando el televisor sea apagado a un nivel de volumen de 31 o más, el nivel de volumen por default será de 30 cuando el televisor sea encendido. Sin embargo, si el nivel está en 30 o menos, este nivel de volumen se mantendrá cuando el televisor sea encendido.

15 Botones del SELECTOR DE CANAL/ CANALES FAVORITOS (FAV CH) y ENTER.

Los botones del **SELECTOR DE CANALES** son usados para seleccionar canales, ingresar código de acceso, etc. Use los botones del **SELECTOR DE CANALES** para ingresar uno, dos, o tres números para seleccionar los canales. Ingrese primero el número "0" para canales del 1 al 9, o simplemente presione el único dígito del canal que se desea sintonizar y presione el botón **ENTER** para que la TV lo sintonice. Para Canales Digitales, use los botones del **SELECTOR DE CANALES** con el botón del **GUIÓN (-)**. La selección de canales también puede ser realizada con el botón **CH UP** (▲) o **CH DOWN** (▼).

Presione el botón **CANALES FAVORITOS (FAV CH)** para cambiar al modo de canal favorito (**FAV**). Usted sabrá cuando está en el modo de Canal Favorito cuando (**FAV**) es desplegado y el # de canal desplegado está VERDE. Presione otra vez para regresar y sintonizar a sus canales regulares. Usted puede agregar cualquier canal a su Lista de Canales Favoritos presionando y manteniendo presionado el botón **FAV CH** hasta que el # de canal desplegado cambie de BLANCO a VERDE RESALTADO. También puede borrar un canal de su lista de canales favoritos presionando y manteniendo presionado el botón **FAV CH** hasta que el # de canal desplegado cambie de VERDE RESALTADO a BLANCO.

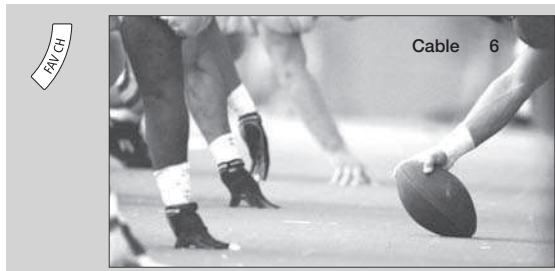
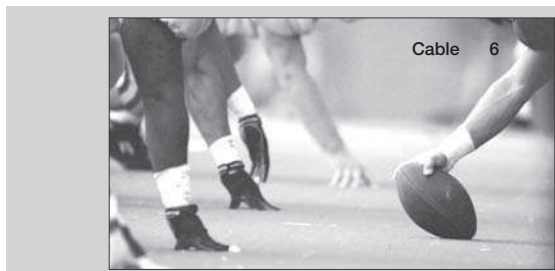

16 Botón de ÚLTIMO CANAL (LAST CH)

Presione este botón para cambiar entre el canal actual y el último canal visto.

17 Botón de GUIÓN (-)

Use el botón de **GUIÓN (-)** junto con los de **SELECCIÓN DE CANALES** para sintonizar Canales Digitales que tienen números de subcanal indicados con un (-) **GUIÓN** (ejemplo: 15-1).

18 Botón de GRABACIÓN (RECORD)

Presione este botón para grabar programas cuando el control remoto está en modo **PVR/VCR**.

El Control Remoto para controlar un receptor de Cable

OPERACIÓN DE LAS FUNCIONES PREGRABADAS PARA SU RECEPTOR DE CABLE.

Este control remoto está diseñado para operar diferentes tipos de receptores de cable. Usted debe primero programar el control remoto para ser compatible con el sistema remoto de su receptor de cable (consulte las páginas 96-97 para ver la lista de códigos).

1. Encienda su receptor de cable.
2. Para cambiar al modo de Cable (CBL), utilice el botón **SOURCE SELECT** en el control remoto para posicionar la luz del **LED** en la selección correspondiente **SAT/CBL**.
3. Mantenga presionado el botón **SOURCE SELECT** en el remoto e ingrese el código de cuatro dígitos preestablecido que coincide con su receptor, como se muestra en las páginas 96-97. Suelte el botón **SOURCE SELECT**. La luz indicadora parpadeará tres veces si el código fue aceptado.
4. Apunte el control remoto hacia el receptor de cable y presione el botón **POWER**. El control apagará su receptor de cable cuando ingrese el código preestablecido de cuatro dígitos correcto. Cuando esto ocurre, el control remoto ya está programado para su receptor. Si su receptor no se apaga, intente un código de cuatro dígitos preestablecido diferente.
5. El control remoto ahora controlará su receptor de cable.

NOTA: 1. Si su receptor no puede ser operado después de realizar los procedimientos anteriores, el código de su receptor no ha sido pregrabado en el control remoto.
 2. En el caso improbable de que su receptor no pueda ser operado después de realizar los procedimientos anteriores, por favor consulte su guía de operación del receptor.
 3. El control remoto recordará los códigos que usted haya programado hasta que se remuevan las baterías del control remoto. Después de reemplazar las baterías, repita el procedimiento completo de programación como se describe arriba.

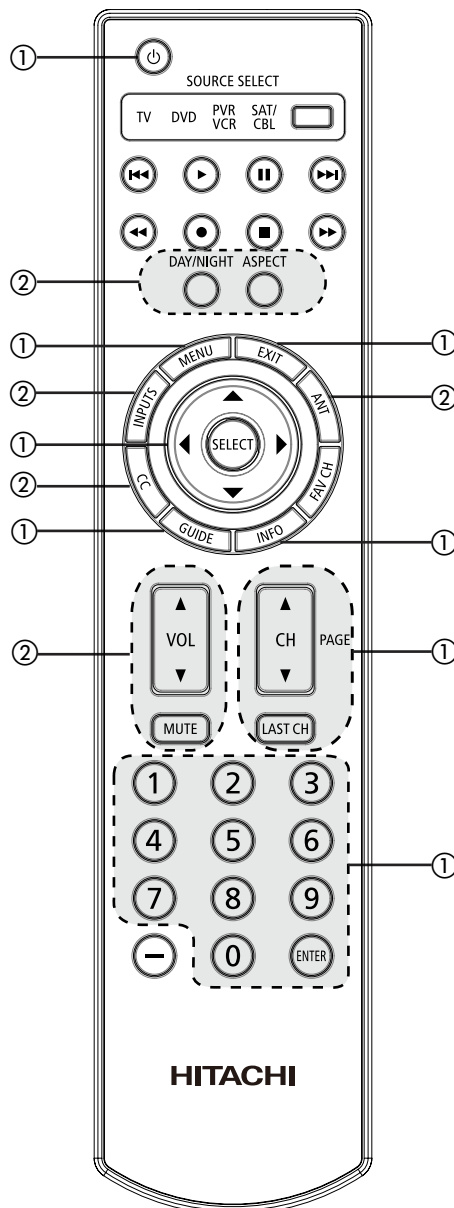

① Botones PREGRABADOS DEL RECEPTOR

Estos botones transmiten los códigos pregrabados al receptor de cable programado :

- Power
- Cursor/Select
- Números
- Menu
- Info
- Enter
- Exit
- Selector de Canales
- Guide
- Last CH

② Botones EXCLUSIVOS DE TV

Estos botones son para operar solamente el TV :

- Day/Night
- CC
- Inputs (Solo si es programado, ver pág. 95)
- Aspect
- Volume
- Mute

EL CÓDIGO DE MI RECEPTOR DE CABLE

ES: _____

NOTA: Consulte la guía de operación del receptor de cable para la operación de los botones exclusivos para el receptor de cable.

El Control Remoto para controlar un STB* Receptor Satelital

OPERACIÓN DE LAS FUNCIONES PREGRABADAS PARA SU STB/RECEPTOR SATELITAL.

Este control remoto está diseñado para operar diferentes tipos de STB/receptores satelitales. Usted debe primero programar el control remoto para ser compatible con el sistema remoto de su receptor de satélite (consulte las páginas 96-97 para ver la lista de códigos).

1. Encienda su STB/Receptor Satelital.
2. Para cambiar al modo de STB/Receptor Satelital (SAT), utilice el botón **SOURCE SELECT** en el control remoto para posicionar la luz del LED en la selección correspondiente **SAT/CBL**.
3. Mantenga presionado el botón **SOURCE SELECT** en el remoto e ingrese el código de cuatro dígitos preestablecido que coincide con su STB/receptor Satelital, como se muestra en las páginas 96-97. Suelte el botón **SOURCE SELECT**. La luz indicadora parpadeará tres veces si el código fue aceptado.
4. Apunte el control remoto hacia el STB/receptor Satelital y presione el botón **POWER**. El control apagará su STB/receptor Satelital cuando ingrese el código preestablecido de cuatro dígitos correcto. Cuando esto ocurre, el control remoto ya está programado para su STB/receptor Satelital. Si su STB/receptor Satelital no se apaga, intente un código de cuatro dígitos preestablecido diferente.
5. El control remoto ahora controlará su receptor de cable.

NOTA:

1. Si su STB/Receptor Satelital no puede ser operado después de realizar los procedimientos anteriores, el código de su STB/Receptor Satelital no ha sido pregrabado en el control remoto.
2. En el caso improbable de que su convertidor no pueda ser operado después de realizar los procedimientos anteriores, por favor consulte su guía de operación del convertidor.
3. El control remoto recordará los códigos que usted haya programado hasta que se remuevan las baterías del control remoto. Después de reemplazar las baterías, repita el procedimiento completo de programación como se describe arriba.

*STB: Set-Top-Box (Receptor de señal de alta definición).

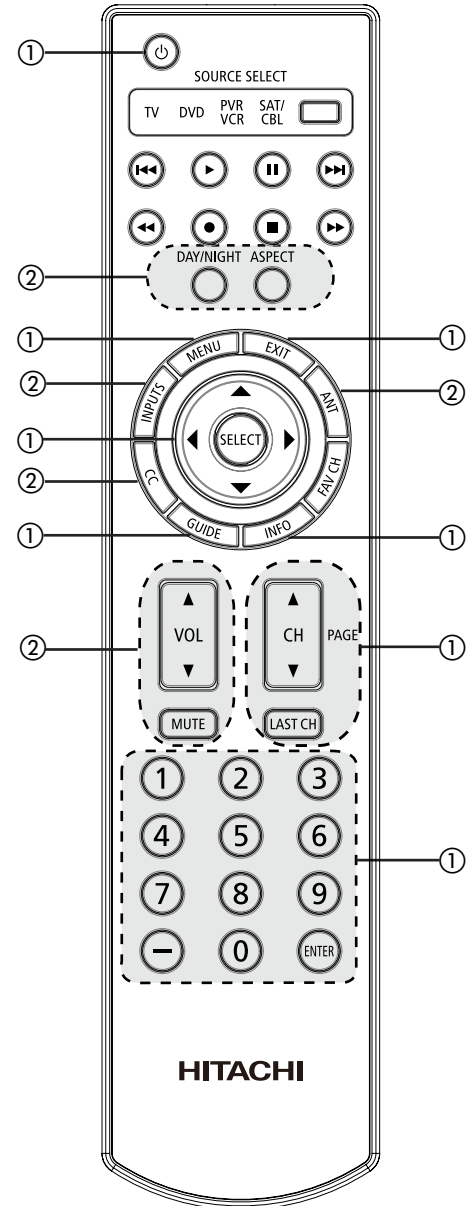

① Botones PREGRABADOS DEL STB/RECEPTOR SATELITAL).

Estos botones transmiten los códigos pregrabados al STB/Receptor Satelital programado:

-Power	-Cursor/Select	-Números, Guión
-Menu	-Info	-Enter
-Exit	-Selector de Canales	
-Guide	-Last CH	

② Botones EXCLUSIVOS DE TV

Estos botones son para operar solamente el TV:

-Day/Night	-CC	-Inputs (Solo si es programado, ver pág. 95).
-Aspect	-Volumen	
-ANT	-Mute	

EL CÓDIGO DE MI STB/RECEPTOR SATELITAL

ES: _____

NOTA: Consulte la guía de operación del STB/Receptor Satelital para la operación de los botones exclusivos para el STB/Receptor Satelital.

El Control Remoto para controlar un reproductor de DVD

OPERACIÓN DE LAS FUNCIONES PREGRABADAS PARA SU REPRODUCTOR DE DVD.

Este control remoto está diseñado para operar diferentes tipos de reproductores de DVD. Usted debe primero programar el control remoto para ser compatible con el sistema remoto de su reproductor de DVD (consulte las páginas 96-97 para ver la lista de códigos).

1. Encienda su reproductor de DVD.
2. Para cambiar al modo de DVD (**DVD**), utilice el botón **SOURCE SELECT** en el control remoto para posicionar la luz del **LED** en la selección correspondiente **DVD**.
3. Mantenga presionado el botón **SOURCE SELECT** en el remoto e ingrese el código de cuatro dígitos preestablecido que coincide con su reproductor de DVD, como se muestra en las páginas 96-97. Suelte el botón **SOURCE SELECT**. La luz indicadora parpadeará tres veces si el código fue aceptado.
4. Apunte el control remoto hacia el reproductor de DVD y presione el botón **POWER**. El control apagará su reproductor de DVD cuando ingrese el código preestablecido de cuatro dígitos correcto. Cuando esto ocurre, el control remoto ya está programado para su reproductor de DVD. Si su reproductor de DVD no se apaga, intente un código de cuatro dígitos preestablecido diferente.
5. El control remoto ahora controlará su reproductor de DVD.

NOTA: 1. Si su reproductor de DVD no puede ser operado después de realizar los procedimientos anteriores, el código de su reproductor de DVD no ha sido pregrabado en el control remoto.
 2. En el caso improbable de que su reproductor de DVD no pueda ser operado después de realizar los procedimientos anteriores, por favor consulte su guía de operación del reproductor.
 3. El control remoto recordará los códigos que usted haya programado hasta que se remuevan las baterías del control remoto. Después de reemplazar las baterías, repita el procedimiento completo de programación como se describe arriba.

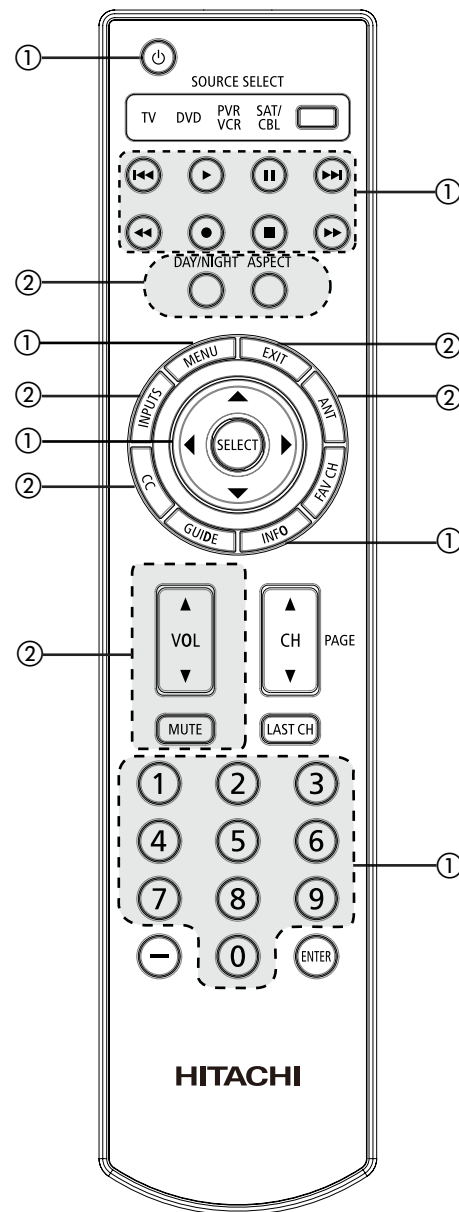

① Botones PREGRABADOS DEL REPRODUCTOR DE DVD.

Estos botones transmiten los códigos pregrabados al reproductor de DVD programado.

- Power
- Números
- Menu
- Reproducir, Detener, Pausa, RWD, FWD,
- Info
- Cursor/Select
- Skip RWD, Skip FWD.

② Botones EXCLUSIVOS DE TV

Estos botones son para operar solamente el TV:

- Day/Night
- Aspect
- ANT
- Exit
- CC
- Volumen
- Mute
- Inputs (Solo si es programado, ver pág.95)

EL CÓDIGO DE MI REPRODUCTOR DE DVD

ES: _____

NOTA: Consulte la guía de operación del reproductor de DVD para la operación de los botones exclusivos para el reproductor de DVD.

El Control Remoto para controlar una VCR/PVR

OPERACIÓN DE LAS FUNCIONES PREGRABADAS DE SU VCR/PVR (Videograbadora personal).

Este control remoto está diseñado para operar diferentes tipos de VCRs/PVRs. Usted debe primero programar el control remoto para ser compatible con el sistema remoto de su VCR/PVR (consulte las páginas 96-97 para ver la lista de códigos).

1. Encienda su VCR/PVR.
2. Para cambiar al modo de VCR/PVR (**PVR/VCR**), utilice el botón de **SOURCE SELECT** en el control remoto para posicionar la luz del LED en la selección correspondiente **PVR/VCR**.
3. Mantenga presionado el botón **SOURCE SELECT** en el remoto e ingrese el código de cuatro dígitos preestablecido que coincide con su VCR/PVR, como se muestra en las páginas 96-97. Suelte el botón **SOURCE SELECT**. La luz indicadora parpadeará tres veces si el código fue aceptado.
4. Apunte el control remoto hacia el VCR/PVR y presione el botón **POWER**. El control apagará su VCR/PVR cuando ingrese el código preestablecido de cuatro dígitos correcto. Cuando esto ocurre, el control remoto ya está programado para su VCR/PVR. Si su VCR/PVR no se apaga, intente un código de cuatro dígitos preestablecido diferente.
5. El control remoto ahora controlará su VCR/PVR.

NOTA: 1. Si su VCR/PVR no puede ser operado después de realizar los procedimientos anteriores, el código de su VCR/PVR no ha sido pregrabado en el control remoto.
2. En el caso improbable de que su VCR/PVR no pueda ser operado después de realizar los procedimientos anteriores, por favor consulte su guía de operación del VCR/PVR.
3. El control remoto recordará los códigos que usted haya programado hasta que se remuevan las baterías del control remoto. Después de reemplazar las baterías, repita el procedimiento completo de programación como se describe arriba.

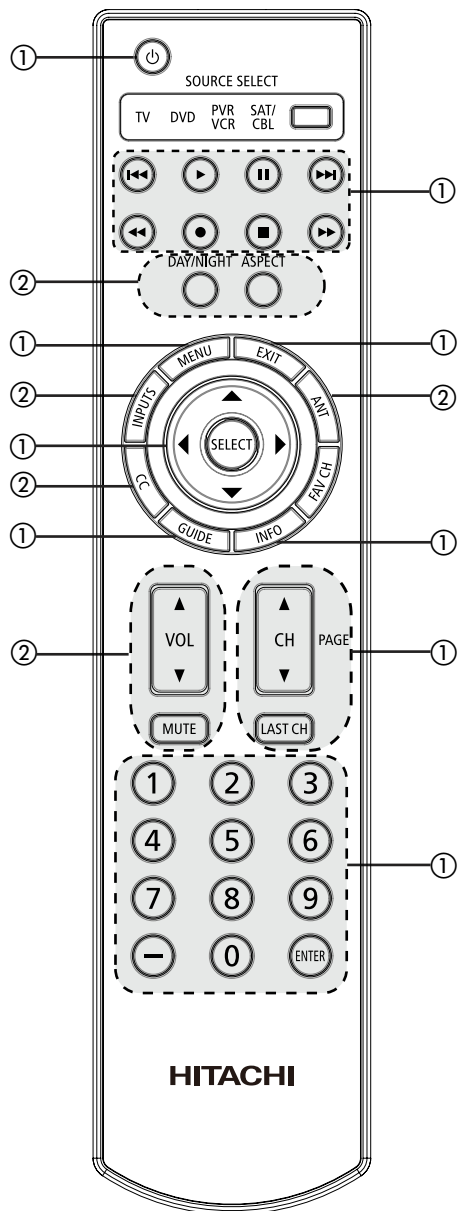

① Botones PREGRABADOS DEL VCR/PVR

Estos botones transmiten los códigos pregrabados al VCR/PVR programado :

-Power	-Cursor/Select	-Enter
-Menu	-Selector de Canales	-Guión (-)
-Exit	-Números	-Reproducir, Pausa, Detener
-Info	-Last CH	-FWD, Skip FWD
-Grabar	-RWD	

② Botones EXCLUSIVOS DE TV

Estos botones son para operar solamente el TV :

-Day/Night	-CC	-Inputs (solo si es programada, ver pág. 95)
-Aspect	-Volumen	
-ANT	-Mute	

EL CÓDIGO DE MI VCR/PVR ES: _____

NOTA: Consulte la guía de operación del VCR/PVR para la operación de los botones exclusivos para el VCR/PVR.

Como utilizar el botón SOURCE SELECT

ACCESO A LAS ENTRADAS

Esta función opcional permite al usuario del control remoto, la configuración de su botón **SOURCE SELECT** para acceder una entrada específica de la TV. La configuración para esta función solamente es aplicable al modo normal del control remoto y solamente es aplicable a los modos de **DVD, PVR/VCR y SAT/CBL**.

1. Seleccione el modo del dispositivo deseado (**DVD, PVR/VCR o SAT/CBL**) utilizando el botón de **SOURCE SELECT** para posicionar el indicador **LED** en la selección correspondiente.
2. Mantenga presionado el botón de **SOURCE SELECT** en el control remoto e ingrese el código de cuatro dígitos preestablecido que sea compatible con su dispositivo como se muestra en las páginas 96-97.
3. Luego, ingrese el número de entrada (1-7) relacionado a donde fue conectado el dispositivo (ver tabla 1).
4. Suelte el botón de **SOURCE SELECT**.
5. Si se realizó correctamente, el indicador **LED** del dispositivo parpadeará 3 veces para confirmar una correcta configuración.
6. El control remoto ahora controlará el dispositivo deseado.
7. Presionando el botón **INPUTS**, se accederá a la entrada de video del dispositivo deseado.

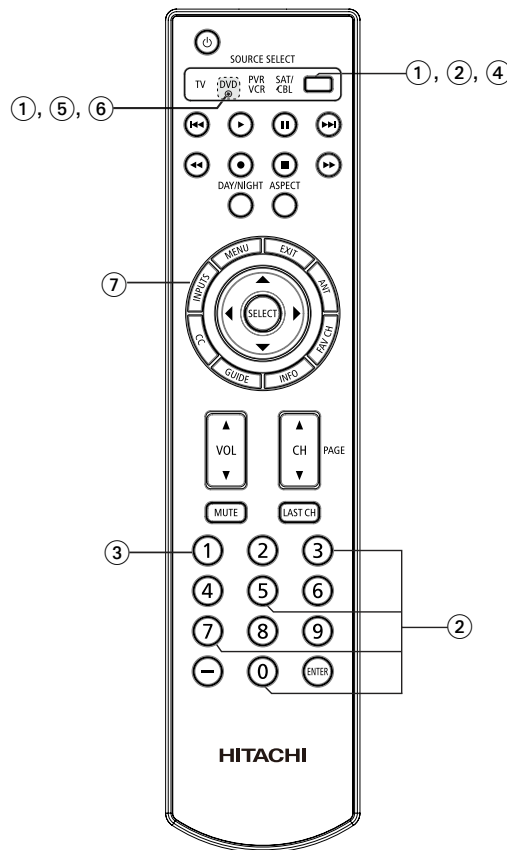

EJEMPLO DE CONFIGURACIÓN (DVD Hitachi con código de lista 0573 conectado a la entrada 1 de la TV).

1. Seleccione el modo **DVD** utilizando el botón de **SOURCE SELECT** para posicionar el indicador **LED** en **DVD**.
2. Mantenga presionado el botón **SOURCE SELECT** y presione los números **0, 5, 7 y 3**.
3. Luego presione el número **1**, que representa el número de entrada asignada al reproductor de DVD.
4. Suelte el botón **SOURCE SELECT**.
5. Si se realizó correctamente, el indicador **LED** del dispositivo parpadeará 3 veces para confirmar una correcta configuración.
6. El control remoto ahora controlará el reproductor de DVD.
7. Presione el botón **INPUTS** para acceder instantáneamente a la entrada de video de su DVD en la entrada 1.

ENTRADA	NUMERO ASIGNADO
ENTRADA 1	1
ENTRADA 2	2
ENTRADA 3	3
ENTRADA- FRONTAL	4
HDMI 1	5
HDMI 2	6
HDMI- FRONTAL	7

NOTA: 1. Esta función es opcional.
2. Si aplica, los números de entrada asignados pueden ser usados más de una vez.

Códigos del Control Remoto

Marca CABLE	Códigos	General Instrument0869	Daewoo0045 0278 0020,0561	1479
ABC	0003,0008,0011	GOI.....0775,1775	1278	Panasonic1062,0035,0162,0225,
Americast	0899	Goodmans1246	Daytron0020	0616,1035,1162,1262
Amino	1602	Hisense1535	Dell1972	Penney0035,0037,0240,0042,
Bell South	0899	Hitachi0819,1250	Denon0042	0038,1035,1237
Clearmaster	0883	HTS0775,1775	DirecTV0739	Pentax0042,0065,0105
ClearMax	0883	Hughes Network System 1142,0749,1749,1442	Durabrand0039,0038	Philco0035,0479
Coolmax	0883	iLo.....1535	Dynatech0000	Philips0035,0081,0062,0618,
Digeo	1187	JVC.....0775,1775	Electrohome0037	0739,1081,1181
Director	0476	LG1226,1414	Electrophonic0037	Pilot0037
General Instrument..0476,0810,0276,0003,	0011	Magnavox0724,0722	Emerex0032	Pioneer0067
		Memorex0724	Emerson0037,0184,0000,0121,	Polk Audio0081
GoldStar.....0144		Mitsubishi0749	0043,0209,0002,0278,	Portland0020
Hamlin0009,0273		Motorola0869	0061,0208,0479,0561,	Presidian1593
Hitachi0011,1421		NEC1270	0593,1278,1479,1593,	Profronic0240
i3 Micro1602		Next Level0869	Fisher0047,0104	Proscan0060,0202,0760,0761
Jerrold0476,0810,0276,0003		Pace0887	Fuji0035,0033	1060
		Panasonic0247,0701	Funai0000,0593,1593	Protec0072
		Paysat0724	Garrard0000	Pulsar0039
Memorex0000		Philips1142,0749,1749,0724,	Gateway1972	Quarter0046
Motorola1376,0476,0810,0276		1076,1254,1106	GE0060,0035,0240,0065,	Quartz0046
			0202,0760,0761,0807,	Quasar0035,0162,1035,1162
Multitech0883		Proscan0392,0566	1035,1060	RadioShack0000,1037
MultiVision0012		Proton1535	Go Video0432,0526	Radix0037
Myrio1602		RadioShack0869	GoldStar0037,0038,1237	Randex0037
Pace1877,0237,0008		RCA0566,0855,0143,1392	Gradiente0000	RCA0060,0240,0042,0149,
Panasonic0000,0107		Samsung1377,1276,1108,1109,	Harley Davidson0000	0065,0105,0106,0202,
Paragon0000		1442,1609	Harman/Kardon0081,0038	0760,0761,0807,0880,
Philips1305,0317		Sanyo1219	Harwood0072	1035,1060
Pioneer1877,0877,0144,0533		SKY0856	Headquarter0046	Realistic0035,0037,0048,0047,
Pulsar.....0000		Sony0639,1639,1640	Hewlett Packard.....1972	0000,0104,0046,0062
Quasar.....0000		Star Choice0869	Hi-Q0047	ReplayTV0614,0616
RadioShack0883		Tivo1142,1442	Hitachi0000,0042,0041,0065,	Ricavision1972
RCA1256		Toshiba0749,1749,0790,1285	0089,0105,0543,0544	Runco0039
Regal0279,0273		UltimateTV1392,1640	Howard Computers1972	Samsung0240,0045,0739,1014
Rembrandt0011		Uniden0724,0722	HP1972	Sanky0048,0039
Runco0000		US Digital1535	Hughes Network System.0042,0739	Sansui0000,0067,0209,0041,
Samsung0144		USDTV1535	Humax0739	0271,0479,1479
Scientific Atlanta1877,0877,0477,0008		Voom0869	Hush1972	Sanyo0047,0240,0104,0046,
Sejin1602		Zenith0856,1856	iBUYPOWER1972	0159
Signature.....0011			Jensen0041	Scott0184,0045,0121,0043
Sony1006		Marca DBS/PVR	JVC0067,0041,0008	Sears0035,0037,0047,0000,
Starcom0003		Combo	KEC0037,0278	0042,0104,0046,0105,
Supercable0276		DirecTV1377,0392,0639,1142,	Kenwood0067,0041,0038	1237
Supermax0883		1076,0099,1392,1442,	KLH0072	Sharp0048,0062,0807,0848
Thomson1256		1640	Kodak0035,0037	Shintom0072
Tocom0012		Dish Network System1505,0775	LG1037	Shogun0240
Torx0003		Dishpro1505,0775	Linksys1972	Singer0072
Toshiba0000		Echostar1505,0775	Lloyd's0000,0208	Sonic Blue0614,0616
Tristar0883		Expressvu0775	Logik0072	Sony0035,0032,0033,0000,
V20883		Hughes Network System.1142,1442	LXI0037	0636,1032,1232,1972
Viewmaster0883		Motorola0869	Magnasonic0593,1278	Stack0009,1972
Vision0883		Philips1142,1442	Magnavox0035,0039,0081,0000,	STS0042
Vortex View0883		Proscan0392	0149,0563,0593,1593,	Sylvania0035,0081,0000,0043,
Zenith0000,0525,0899		RCA1392	1781	0593,1593,1781
		Samsung1442	Magnin0240	Symphonic0000,0593,1593
		Sony0639,1640	Marantz0035,0081	Systemax1972
		Star Choice0869	Marta0037	Tagar Systems1972
			Matsushita0035,0162,1162	Tatung0041
Marca Cable/PVR	Códigos		Media Center PC1972	Teac0000,0041
Combo			MEI0035	Technics0035,0162
Americast0899			Memorex0035,0162,0037,0048,	Teknika0035,0037,0000
Digeo1187			0039,0047,0240,0000,	Thomas0000
General Instrument .0810			0104,0209,0046,0307,	Tivo0618,0636,0739,1996
Jerrold0810			0479,1037,1162,1237	TMK0240,0208
Motorola1376,0810,1187,1106			1262	Toshiba0045,0043,0845,1008,
Pace1877,0237			MGA0240,0043,0061	1145,1972,1996
Pioneer1877,0877			MGN Technology0240	Totevision0037,0240
RCA1256			Microsoft1972	Touch1972
Scientific Atlanta1877,0877			Mind1972	Unitech0240
Sony1006			Minolta0042,0105	Vector0045
Supercable0276			Mitsubishi0067,0043,0061,0807	Vector Research0038
Thomson1256			Motorola0035,0048	Video Concepts0045,0061
Zenith0899			MTC0240,0000	Videomagic0037
			Multitech0000,0072	Videosonic0240
Marca SATELITE	Códigos		NEC0104,0067,0041,0038	Viewsonic1972
(Set Top Box)			Nikko0037	Villain0000
AlphaStar0772			Niveus Media1972	Voodoo1972
Chaparral0216			Noblex0240	Wards0060,0035,0048,0047,
Crossdigital1109			Northgate1972	0081,0240,0000,0042,
DirecTV1377,0392,0566,0639,			Olympus0035	0072,0149,0062,0760
1639,1142,0247,0749,			Onkyo0222	White Westinghouse0209,0072
1749,0724,0819,1856,			Optimus1062,0162,0037,0048,	XR-10000035,0000,0072
1076,1108,0099,1109,			0104,0432,0593,1048,	Yamaha0038
1414,1442,1609,1392,			1162,1262	Zenith0039,0033,0000,0209,
1640			Optonica0062	0479,1139,1479
Dish Network System 1505,1005,0775,1775			Orion0184,0209,0002,0479	ZT Group1972
Dishpro1505,1005,0775,1775				
Echostar1505,1005,0775,1775				
Expressvu0775,1775				
GE0566				

Códigos del Control Remoto

Marca DBS/PVR Combo	Códigos	Enterprise	0591	Sony	0533,1533,0864,1033,1431
Hughes Network Systems	0739	ESA	0821,1268	Sova	1122
Philips	0739	Fisher	0670,1919	Sungale	1074
Samsung	0739	Funai	0675,1268,1334	Superscan	0821
		Gateway	1073,1077,1158	SVA	0860,1105
		GE	0522,0815,0717	Sylvania	0675,0821,1268
Marca PVR	Códigos	Go Video	0744,0715,0741,0783,0833,0869,1044,1075,1099,1144,1158,1304,1730	Symphonic	0675,0821
ABS	1972			Teac	0758,0790,0809
Alienware	1972			Technics	0490,0703
CyberPower	1972	Go Vision	1071,1072	Technosonic	0730
Dell	1972	GoldStar	0741	Techwood	0692
DirectTV	0739	GPX	0699,0769	Terapin	1031
Gateway	1972	Greenhill	0717	Theta Digital	0571
Hewlett Packard	1972	Harman/Kardon	0582,0702	Toshiba	0503,0695,1045,1154
Howard Computers	1972	Hitachi	0573,0664,1247,1919	Tredex	0799,0800,0803,0804
HP	1972	Hiteker	0672	TYT	0705
Hughes Network Systems	0739	iLo	1348	Urban Concepts	0503
Humax	0739	Initial	0717	US Logic	0839
Hush	1972	Insignia	1268	Venturer	0790
iBUYPOWER	1972	Integra	0627	Vizio	1064,1226
Linksys	1972	JBL	0702	Xbox	0522
Media Center PC	1972	Jensen	1016	Yamaha	0490,0539,0545
Microsoft	1972	JSI	1423	Zenith	0503,0591,0741,0869
Mind	1972	JVC	0558,0623,0867,1164	Zoece	1265
Niveus Media	1972	jWin	1049,1051		
Northgate	1972	Kawasaki	0790	DVD-R	Codes
Panasonic	0616	Kenwood	0490,0534,0682,0737	Accurian	1416
Philips	0618,0739	KLH	0717,0790,1020,1149	Apex Digital	1056
RCA	0880		1261	Aspire Digital	1168
ReplayTV	0614,0616			Coby	1086
Samsung	0739	Konka	0711,0719,0720,0721	CyberHome	1129
Sonic Blue	0614,0616	Koss	0651,0896,1423	Funai	0675,1334
Sony	0636,1972	Landel	0826	Gateway	1073,1158
Stack	0009,1972	Lasonic	0798,1173	Go Video	0741,1158,1304,1730
Systemax	1972	Lenoxx	1127	iLo	1348
Tagar Systems	1972	LG	0591,0741,0801,0869	JVC	1164
Tivo	0618,0636,0739	LiteOn	1058,1158,1416,1440	LG	0741
Toshiba	1008,1972,1996	Loewe	0511	LiteOn	1158,1416,1440
Touch	1972	Magnavox	0503,0539,0646,0675,0821,1268	Magnavox	0646,0675
Viewsonic	1972			Panasonic	0490
Voodoo	1972	Malata	0782,1159	Philips	0646
ZT Group	1972	Marantz	0539	Pioneer	0631
		Memorex	0695,0831,1270	Polaroid	1086
		Microsoft	0522	RCA	0522
Marca DVD	Códigos	Mintek	0839,0717	Samsung	0490
Accurian	1072,1416	Mitsubishi	1521,0521	Sensory Science	1158
Advent	1016	Momitsu	1082	Sharp	0675
Aiwa	0641	NAD	0741	Sony	1033,1431
Akai	0695,0770,0899,1089	NEC	0785	Sylvania	0675
Alco	0790	Nesa	0717	Zenith	0741
Allegro	0869	Next Base	0826		
Amphion Media Works	0872	NexxTech	1402		
AMW	0872	Norcent	1003,0872,1107,1265		
Apex Digital	0672,0717,0755,0794	Onkyo	0503,0627,0792		
	0795,0796,0797,0830	OptoMedia Electronics	0896		
	1004,1020,1056,1061	Oritron	0651		
	1100	Panasonic	0490,0632,0703,1362,1462,1490,1762		
Arrgo	1023	Philco	0690,0733,0790,0862,1855,2000		
Aspire Digital	1168,1407				
Audiologic	0736,	Philips	0503,0539,0646,0675,0854,1260,1267,1354		
Audiovox	0790,1041,1071,1072				
	1121,1122	Pioneer	0525,0571,0631,0632		
Axion	1071,1072	Polaroid	1020,1061,1086		
B & K	0655,0662	Polk Audio	0539		
Blaupunkt	0717	Portland	0770		
Blue Parade	0571	Presidian	0675,1072		
Broksonic	0695,0868	Prima	1016		
Cambridge Soundworks	0690	Proscan	0522		
Cinea	0831	ProVision	0778		
CineVision	0876,0833,0869	Qwestar	0651		
Citizen	1277	RCA	0522,0571,0717,0790,0822,1022,1132,1193		
Coby	0778,0852,1086,1107				
	1165,1177,1351	Rio	0869		
Craig	0831	Rotel	0623		
Curtis Mathes	1087	Rowa	0823		
CyberHome	0816,0874,1023,1024	Sampo	0698,0752		
	1117,1129,	Samsung	0490,0573,0820,0899,1044,1075		
Daewoo	0784,0705,0833,0869				
	1169,1172,1234,1242	Sansui	0695		
Denon	0490,0634	Sanyo	0670,0695,0873,1919		
Desay	1407	Sensory Science	1158		
Disney	0675,1270	Sharp	0630,0675,0752,1256		
Dual	1068,1085	Sharper Image	1117		
Durabrand	1127	Sherwood	0633,0770,1043,1077		
DVD2000	0521	Shinonic	0533,0839		
Emerson	0591,0675,0821,1268	Sonic Blue	0869,1099		

Menú en Pantalla

1. Presione **MENU** en el control remoto para desplegar las diferentes funciones de su TV LCD **HITACHI**.
2. Utilice los **CURSORES** (botones ▲, ▼, ◀ y ▶) para navegar por las diferentes opciones del menú. Presione el botón **SELECT** para seleccionar o elegir.
3. Presione **EXIT** en el control remoto para salir rápidamente de cualquier menú.

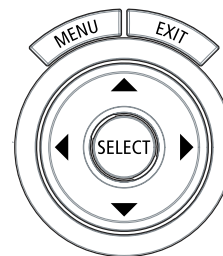

Esta parte del menú en pantalla muestra cuales son las opciones disponibles.

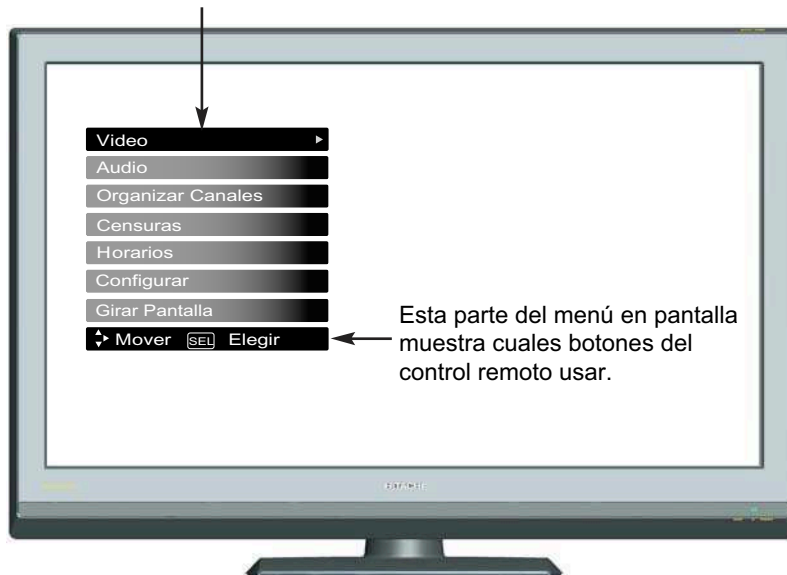

Esta parte del menú en pantalla muestra cuales botones del control remoto usar.

- Notas:** 1. El menú preestablecido de fábrica está en idioma Inglés, para lograr verlo en idioma español favor de elegir el menú **Configurar**, luego elegir **Configurar el Menú** y cambiar en **Lenguaje** de inglés a español.
 2. Las pantallas de los diferentes submenús que se muestran en las siguientes páginas son con fines ilustrativos, por lo tanto; no reflejan la apariencia actual del menú en pantalla de su televisor LCD **HITACHI**.

Video

Modo de Imagen	Seleccione uno de los tres modos; Día (Dinámico), Día (Normal) y Noche.
Contraste	Ajusta el contraste.
Brillantez	Ajusta el brillo.
Color	Ajusta el color de la imagen.
Tinte	Ajusta el tinte de la imagen.
Nitidez	Ajusta la nitidez de la imagen.
Luz del Panel	Ajusta la intensidad de la fuente de luz posterior del panel.
Temperatura de color	Elija el modo ALTA para una menor intensidad de color con más azul, elija MEDIA para un color natural, ESTANDAR para colores estándares o BLANCO/NEGRO para colores más rojizos.
Realzar Nivel de Negro	Acentúa el negro de la imagen en escenas oscuras.
Modo de Contraste	Utilice esta función para elegir entre dos configuraciones de Modo de Contraste, Normal y Dinámico.

Reducción de Ruido	Reduce el ruido visible en la imagen.
MPEG-NR	Reduce el ruido mosquito en la imagen.
Modo Autom. de Cine	Enciende/Apaga la función de detección 3:2.
Auto Color	La función de AUTO COLOR automáticamente monitorea y ajusta el color para mantener los niveles de color constantes aún después de cambiar canal o programa. También mantiene los tonos naturales de la piel mientras preserva los colores de fondo.
Panel Lateral Oscuro	Cambia las barras laterales de grises a negras cuando se encuentra viendo señales 4:3 en el modo estándar.
Aspecto	Seleccione la relación de aspecto del formato de imagen.
Restaurar Video	Seleccione esta opción para restaurar a las condiciones de video de fábrica.

Menú en Pantalla

Audio

Agudos	Ajusta los sonidos agudos.
Bajos	Ajusta los sonidos bajos.
Balance	Ajusta el balance.
Surround	Selecciona las opciones del Sonido Surround (Off, Normal, Amplio)
Bass Boost	Activa/Desactiva la opción Bass Boost.
Tipo de Audio	Selecciona entre tres tipos de Audio disponibles.
Bocinas Internas	Selecciona las bocinas internas o bocinas externas.
Auto Cancelar Ruido	Elimina el ruido entre estaciones o entre canales.
Volumen Perfecto	Ajusta el volumen a un nivel fijo.
Realzar Audio	Selecciona On para realzar audio.
Lenguaje	Selecciona las opciones de Lenguaje cuando están disponibles.
Salida Digital DRC	Selecciona opciones de salida óptica. Activa o desactive la compresión de rango dinámico (DRC).
Sincronía del Audio	Utilice esta opción para sincronizar el audio con la imagen en las fuentes de señal digitales y analógicas

NOTA: Las opciones de Lenguaje, Salida Digital y DRC del menú de Audio solo están disponibles para canales digitales.

Organizar Canales

Medidor de Señal	Accese al medidor de señal.
Auto Programar Canales	Activa el autoprogramador de canales.
Lista de Canales	Configure la lista de canales.

Censuras

¿Desea Cambiar Clave?	Cambie la clave de acceso.
Activar Bloqueo	Elija para bloquear canal y/o el panel frontal.
Clasificación de Cine	Bloquee varios tipos de películas y tipos de video basados en la clasificación de las imágenes.
Clasificación de TV	Bloquee varios tipos de películas y programas de TV basados en la clasificación de programas.
Clasificación para Canadá (Inglés)	Bloquee varios tipos de películas y programas de television basados en el sistema de clasificación de Canadá.
Clasificación para Canadá (Francés)	Bloquee varios tipos de películas y programas de television basados en el sistema de clasificación Franco/canadiense.
Región 5	Sistema de Clasificación para señal Digital para bloquear diferentes tipos de programas.

Horarios

Fijar el Reloj	Configure las opciones del reloj.
Tiempo de Auto-Apagado	Seleccione el intervalo de auto-apagado (cada 30 min., 00:30-3:00).
Programar Modo Día/Noche	Configure las opciones de los tres modos de imagen.
Configurar Eventos	Configure los eventos que desea programar.

Configurar

Configurar el Menú	Seleccione idioma del menú Inglés, Francés o Español y fondo.
Ahorro de Energía	Función para el ahorro de energía.
Configurar Entradas	Nombre las entradas de video, VCR, DVD, etc.
Subtítulos	Opción para desplegar diálogo/texto.
Elegir la Opción de Inicio Rápido	Seleccione la opción de Inicio Rápido del televisor.
Restablecer el Programa	Seleccione para ver/actualizar la versión de software y restablecer la configuración del televisor.

Girar Pantalla

Activado	La opción Girar Pantalla está habilitada. Controle la base giratoria motorizada.
Desactivado	La opción Girar Pantalla está deshabilitada.

NOTA: 1. El Medidor de Señal del menú Organizar Canales solamente está disponible para canales digitales.
2. El menú Girar Pantalla solamente está disponible cuando la Base Giratoria del TV está conectada.

Video

Seleccione **VIDEO** para ajustar las opciones de la imagen y mejorar la calidad de la misma. Usted podrá configurar independientemente cada entrada de Video como prefiera, para mejorar el desempeño y lograr una visión placentera dependiendo del programa de video que se esta viendo. Si se selecciona **RESTAURAR VIDEO**, solo la entrada seleccionada volverá a las condiciones originales de fábrica.

Modo de Imagen

Utilice esta función para elegir una de las opciones automáticas de la imagen para optimizar el desempeño de su TV.

1. Utilice los botones del **CURSOR** ◀ o ▶ para resaltar y seleccionar las opciones del **MODO DE IMAGEN** **Día-Normal, Día-Dinámico o Noche**).
2. Luego presionar el botón **SELECT** para elegir el modo y regresar al menú de Video ó presionar **EXIT** para salir.
3. Existen tres modos de imagen disponibles para el usuario, **Día (Dinámico), Día (Normal)** y modo **Noche**. **Día (Dinámico)** es el modo preestablecido de fábrica, esto puede ser cambiado ajustando cualquier opción de video a sus preferencias personales. El modo **Día (Normal)** puede ser usado como segunda opción para visualización en el día mientras que el modo **Noche** está configurado para ver programación nocturna.

1. Use los **CURSORES** ▲ o ▼ para resaltar la función que va a ser ajustada.
2. Presione el botón **SELECT** o el **CURSOR** ▶ para seleccionar las opciones de la función.
3. Presione los **CURSORES** ◀ o ▶ para ajustar la función seleccionada.
4. Presione **MENU** para regresar al menú principal.
5. Presione **EXIT** para salir del menú.

Contraste

Use esta función para cambiar el contraste entre los niveles de blanco y negro en la imagen.

Brillantez

Use esta función para ajustar el brillo total de la imagen.

Color

Use esta función para ajustar el nivel de color en la imagen.

Tinte

Use esta función para ajustar los tonos de piel para que parezcan naturales.

Nitidez

Use esta función para ajustar la cantidad de detalles finos en la imagen.

Luz del panel

Use esta función para ajustar la intensidad de la fuente de luz detras del panel de cristal líquido.

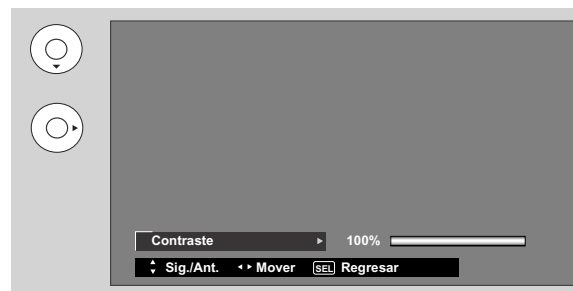
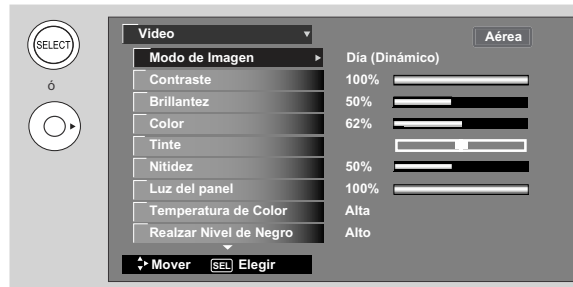

Video

Temperatura de Color

Configure esta opción a **ALTA** para un color más frío (azulado), a **MEDIA** para un color más natural, a **ESTÁNDAR** para un color más preciso o a **BLANCO/NEGRO** para un color más rojizo .

Realzar Nivel de Negro

Use esta función para realzar los detalles de sombra en escenas oscuras utilizando las opciones de **off**, **bajo**, **medio** y **alto**.

NOTA: 1. Si se elige **CONTRASTE**, usted ajustará el **CONTRASTE** de la imagen. Las demás opciones del menú como **BRILLO**, **COLOR**, **TINTE** y **NITIDEZ** pueden ser seleccionadas y ajustadas de la misma manera.
2. Puede ser necesario ajustar el **TINTE** para obtener una calidad de imagen óptima cuando se utilizan las entradas de VIDEO COMPONENTE Y-PbPr.
3. **CABLE** y **AÉREA** comparten la misma configuración de Video. También, cada entrada de video posee su propia configuración de video.

Modo de Contraste

Use esta función para elegir entre los dos modos de contraste definidos. Configure a **DINÁMICO** para obtener imágenes más oscuras en el nivel del negro, configure a **NORMAL** para obtener un nivel de Blanco a Negro balanceado.

Reducción de Ruido

La función de Reducción de Ruido automáticamente reduce el ruido visible en la imagen sin degradar la calidad de la misma. Configure la función Reducción de Ruido a **OFF** si la TV experimenta bloqueo de la imagen.

MPEG NR

La función de MPEG NR (Reducción de Ruido MPEG) automáticamente reduce el ruido mosquito en la imagen sin degradar la calidad de la misma. Configure la función MPEG NR a **OFF** si la TV experimenta bloqueo de la imagen.

Modo Automático de Cine

La función **Modo Automático de Cine** activa o desactiva la función especial de detección y conversión 3:2.

Las películas de cine son filmadas a 24 marcos o imágenes fijas por segundo, en vez de 30 marcos o 60 campos como el video. Cuando la películas es transferida a video para visualización en televisión, la disparidad entre las dos tasas de marcos debe ser compensada. Esto involucra un proceso conocido como detección y conversión 3:2.

Cuando la función **Modo Automático de Cine** es activado del Menú de **VIDEO**, su televisión de LCD **HITACHI** activará la circuitería para esta función especial para mejorar el desempeño de video cuando se ven fuentes o películas de cine.

Auto Color

La función de **Auto Color** automáticamente monitorea y ajusta el color para mantener niveles de color constantes aún después de un cambio de canal o programa. También mantiene los tonos naturales de la piel mientras conserva los colores del fondo.

NOTA: Cuando reciba un canal digital por antena, use la entrada de componente o HDMI, la función **Auto Color** no estará disponible (gris).

Panel Lateral Oscuro

La función de **PANEL LATERAL OSCURO** cambia las barras laterales de grises a negras cuando se ven señales 4:3 en el modo Estándar.

1. Presione los **CURSORES** ◀ o ▶ para activar o desactivar.

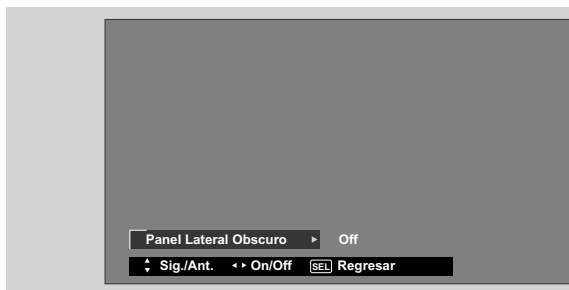

2. Presione **EXIT** para salir del menú o seleccione **PANEL LATERAL OSCURO** para regresar al menú previo.

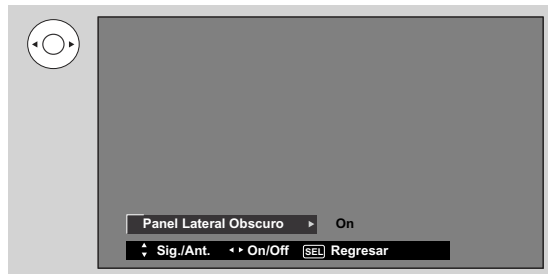

- NOTA:** 1. Para prevenir envejecimiento desigual cuando se ve una señal 4:3, desactive el **Panel Lateral Oscuro**. Se recomienda ver la señal 4:3 con la barra lateral gris.
2. Esta función regresa automáticamente a Off cuando se apaga y se enciende la TV.

Aspecto

Use esta función para seleccionar la relación de aspecto del formato de imagen.

Formato Automático

Automáticamente ajusta la relación de aspecto dependiendo del llenado de pantalla de la señal de entrada.

Formato

Seleccione manualmente la relación de aspecto.

Posición Vertical

Esta función le permite seleccionar cuando el formato del aspecto es tipo 4:3 **EXPANDIDO/ZOOM1/ZOOM2** o **16:9 ZOOM**. la posición vertical. Por ejemplo, será útil para centrar el área de la imagen tanto arriba como abajo de una imagen con señal 480i/480p. Un rango ajustable es -10 (el centro de video esta hacia abajo de la pantalla) a +10 (el centro de video esta hacia arriba de la pantalla).

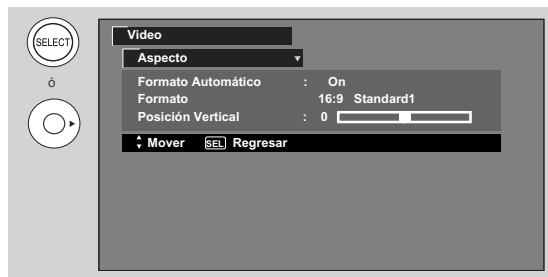

1. Use los **CURSORES ▲** o **▼** para seleccionar una opción del menú.
2. Presione el **CURSOR ◀** o **▶** para ajustar la función.
3. Presione **EXIT** para salir del menú, o elija **ASPECTO** para regresar al menú principal.

- NOTA:** 1. La **Posición Vertical** no estará disponible en los modos **4:3 Estándar** y los modos **16:9 Estándar**.
2. La **Posición Vertical** regresa automáticamente a "0" cuando se apaga y se enciende la TV.

Restaurar Video

Esta función le permite restaurar las opciones del menú de video de la entrada actual y regresarla al modo de **VIDEO DIA-DINAMICO**.

1. Use los **CURSORES ▲, ▼** para resaltar las funciones deseadas.
2. Presione el botón **SELECT** o el **CURSOR ▶** para elegir **RESTAURAR VIDEO**.
3. Use el **CURSOR ▼** para acceder al botón de **RESET**.
4. Presione el botón **SELECT** para restaurar el Video.

Usted puede personalizar cada una de las entradas de Video a su preferencia para incrementar el desempeño y así lograr una visión placentera, dependiendo del programa que se este viendo. Si se selecciona el botón **RESET**, solamente la entrada seleccionada será restaurada a las condiciones originales de video como se explica arriba.

Si el **RESET** es seleccionado en la entrada 1, solamente la Entrada 1 se restaurará a las condiciones de video originales de fábrica.



Audio

Seleccione el menú **AUDIO** para ajustar la TV a su preferencia y mejorar la calidad del sonido.

1. Presione los **CURSORES ▲** o **▼** para elegir la opción del menú.
2. Presione los **CURSORES ◀** o **▶** para ajustar la función.
3. Presione **EXIT** para salir del menú, o seleccione **AUDIO** para regresar al menú principal.

NOTA: Si usted selecciona **Agudos**, usted ajustará los tonos agudos. Las opciones adicionales del menú **Bajos** y **Balance** pueden ser seleccionados y ajustados de la misma manera.



Agudos

Esta función controla los sonidos de alta frecuencia hacia todas las bocinas.

Bajos

Esta función controla los sonidos de baja frecuencia hacia todas las bocinas.

Balance

Esta función controlará el balance izquierdo a derecho de las bocinas internas de la televisión de LCD **HITACHI**.

Surround

El sonido **Surround** es el concepto de expandir la percepción espacial del audio de una dimensión (Mono/Izquierdo-Derecho) a dos o tres dimensiones. Esto se realiza con frecuencia para crear un ambiente de audio más real.

- 1.- Use los **CURSORES ▲** o **▼** para resaltar la opción **Surround**.
- 2.- Use los **CURSORES ◀** o **▶** para seleccionar las opciones **OFF**, **NORMAL** o **AMPLIO**.

Off: Desactiva el efecto de sonido Surround.

Surround Normal : Entrega el efecto Surround por medio de la localización de dos o más bocinas atrás del oyente.

Surround Amplio : Reproduce con mucho mejor calidad las señales de sonido de 5 canales del contenido estéreo ordinario comparado con la tecnología de surround normal. Surround Amplio permite al usuario disfrutar una reproducción de sonido en un área virtual amplia como el contenido de 5 canales con un contenido estéreo ordinario.

Bass Boost

Esta función permite incrementar el desempeño del sonido de bajas frecuencias en su sistema de bocinas.

Audio

Tipo de Audio

El sonido multicanal de Televisión (MTS-Multichannel Television Sound) le permitirá seleccionar **ESTÉREO** (transmisión estéreo), **MONO** (sonido monoaural) usado cuando se recibe una señal de transmisión estéreo débil o **SAP** (SECOND AUDIO PROG-Segundo Programa de Audio) que puede ser un idioma diferente, un reporte de clima, etc.

Bocinas Internas

Esta función es útil cuando se configuran las bocinas externas.

ON	Seleccione esta opción si se utilizan solo las bocinas internas.
TV como Centro	Seleccione esta opción cuando se configuran las bocinas externas de un sistema estéreo separado. Las bocinas de la TV trabajarán como la bocina central.
OFF	Seleccione esta opción si usted prefiere usar solo bocinas de un sistema estéreo separado.

Auto Cancelar Ruido

Esta función elimina el ruido entre estaciones. Si un canal es sintonizado y está ruidoso, esta función automáticamente eliminará el audio de ese canal.

Volumen Perfecto

Esta función automáticamente ajustará el volumen, para que cada canal y entrada tenga el mismo nivel promedio de volumen.

Realzar Audio

Active esta función para enfatizar los bajos y agudos a niveles de volumen pequeños.

Lenguaje

Algunos programas transmiten un programa DTV con más de una opción de lenguaje o idioma. La mayoría tienen al Inglés como idioma por default. Esta función le permitirá seleccionar hasta 14 opciones de lenguaje (si están disponibles).

Salida Digital

Esta función le permite seleccionar entre los sistemas **Dolby® Digital** y **PCM** los cuales alimentan la Salida Óptica.



Dolby® Digital - Seleccione esta opción si la TV está conectada a un amplificador/receptor con decodificador **Dolby® Digital**. Este le dará seis canales independientes de pista de audio a través de una salida óptica (Audio Digital).

NOTA: *Incorporada bajo la licencia de Laboratorios Dolby. "Dolby" y el símbolo de la doble D son marcas registradas de los Laboratorios Dolby.

PCM - Seleccione esta opción si la TV está conectada a un amplificador/receptor con decodificador PCM solamente; el cual le proporcionará dos canales independientes de pista de audio a través de una salida óptica (Audio Digital).

DRC (Dynamic Range Control)

Compresión Dinámica de Rango - Use esta función para comprimir el rango del volumen del sonido. Al comprimir el rango del volumen del sonido, es posible no solamente suprimir la salida alta de sonido en la noche sino también elevar el volumen de audio bajo. La configuración por default es **ON**.

Use los **CURSORES** ◀ o ▶ para seleccionar las opciones deseadas.

NOTA: Las funciones **Lenguaje**, **Salida Digital** y **DRC** están solo disponibles en programas de transmisión digital.

Use las funciones de la derecha si su TV está conectada a un amplificador/receptor con entrada digital óptica con capacidades de decodificación **Dolby® Digital** o **PCM**.

NOTA: 1.- El control **DRC** afecta solo señales **Dolby® Digital** decodificadas internamente por la TV.
2.- **DRC** no afecta a la señal **Dolby® Digital** disponible en la salida de audio digital.

Sincronía de Audio

Utilice esta función para sincronizar la señal de audio con la imagen de fuentes digitales ó analógicas. Utilice los **CURSORES** ◀ ó ▶ para sincronizar la señal de audio con la imagen. El valor predeterminado es de 0.



Organizar Canales

Organizar Canales

Seleccione **ORGANIZAR CANALES** para configurar las opciones de la antena, correr la autoprogramación de canales, verificar el medidor de señal y configurar la lista de canales.

1. Presione los **CURSORES** ▲, ▼ para resaltar la función en el menú.
2. Presione el botón **SELECT** o el **CURSOR** ► para seleccionar.

Medidor de Señal

Seleccione el **Medidor de Señal** cuando utilice una antena para interiores o exteriores. Esta función mostrará la potencia y los valores pico de la señal de la antena para ayudar a ajustarla y así optimizar la recepción de la señal.

Use los **CURSORES** y el botón **SELECT** para resaltar y seleccione **CLOSE** para salir del menú.

NOTA: El Medidor de Señal no estará disponible (gris) cuando se sintonicen canales analógicos.

Auto Programar Canales

Esta función guardará automáticamente los canales analógicos y digitales activos en la memoria de Autoprogramación.

1. Use los **CURSORES** ◀ o ▶ para resaltar el origen **AÉREA**, **CABLE (1)** o **CABLE(2)**.
2. Presione los **CURSORES** ◀ o ▶ para resaltar la opción **START** o **RESET**.
3. Presione el botón **SELECT** para seleccionar.

NOTA: Si algunos canales son débiles o indetectables en el modo cable(1), cambie al modo cable(2) utilizando los **CURSORES** ◀ o ▶.

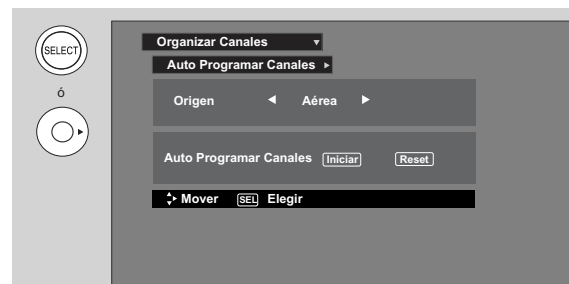
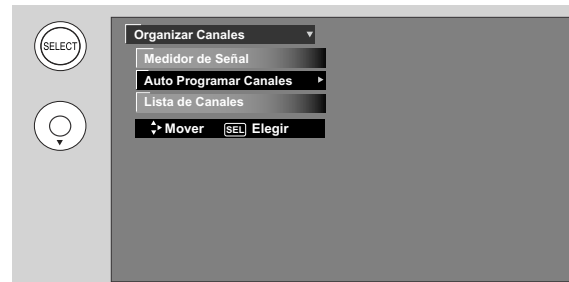
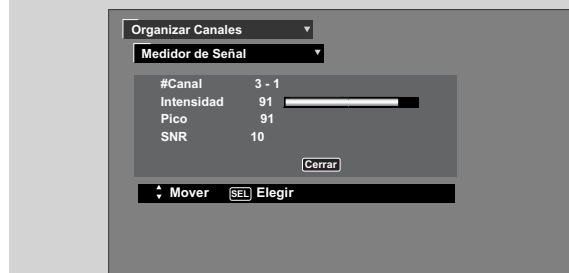

Organizar Canales

Lista de Canales

Esta función permite revisar cuales canales están etiquetados (**ID**), cuales están agregados a la memoria de canales, cuales están censurados y cuales son sus canales favoritos (**FAV**).

1. Use los **CURSORES** para navegar la Lista de Canales.
2. Presione el botón **SELECT** para elegir **ON** u **OFF** en las columnas **Buscar** y **Censura**.
3. Para elegir la columna **Censura**, ingrese el código de acceso (Código de acceso por default: **0000**).
4. Presione los **CURSORES** para activar o desactivar las opciones de canal **FAVORITO**.
5. Presione el botón **EXIT** para regresar a la vista normal.



NOTA: La lista de canales no puede ser actualizada con solo cambiar de origen de cable. Se debe correr la autoprogramación de canales para que pueda ser actualizada la lista de canales.

Noticia: La Ley Federal de los Estados Unidos requiere que las estaciones de TV paren de transmitir señales de televisión analógica (no digital) después del 17 de Febrero del 2009.

De acuerdo a esto, el sintonizador analógico de su TV no será capaz de recibir ninguna transmisión analógica aérea cuando estos canales analógicos no estén ya disponibles.

Después del 17 de Febrero del 2009, el sintonizador analógico de su TV continuará trabajando con sistemas compatibles de cable y satélite, consolas de juegos, VCRs, reproductores de DVD y otros productos similares.

Antes y después del 17 de Febrero del 2009, el sintonizador digital de esta TV recibirá transmisiones digitales aéreas disponibles utilizando una antena, además recibirá otros programas de televisión digital utilizando conexiones de sistemas de televisión digital compatibles, de cable o satélite.

Para mayor información con respecto a estas conexiones, por favor revise este manual de operaciones de usuario.

Censuras

Esta función bloqueará la imagen y el sonido del canal o entrada de video seleccionada.

El código para ingresar al menú **CENSURAS** es un número de acceso de cuatro dígitos. El código preestablecido de fábrica es **0000**. Use los botones de **NÚMERO** para ingresar el código de acceso.

1. Use los **CURSORES** ▲, ▼ para resaltar la función deseada en el menú **CENSURAS**.
2. Presione el botón **SELECT** para elegir.

¿Desea Cambiar Clave?

1. Para cambiar el número del código de acceso, seleccione **¿Desea Cambiar Clave?** para cambiar el código preestablecido de fábrica (0000) al de su preferencia.

Si olvida su número de código de acceso, use el código de fábrica **7777** para borrar tu número clave. Esto restaurará el número de código de acceso al preestablecido de fábrica (**0000**).

2. Ingrese un número nuevo de cuatro dígitos.
3. Presione **EXIT** para salir del menú.

Activar Bloqueo

Cuando se selecciona **ACTIVAR BLOQUEO**, las opciones de **BLOQUEAR CANAL** y **BLOQUEAR PANEL DE CONTROL** pueden ser configurados individualmente.

Cuando se activa **BLOQUEAR CANAL**, la imagen y el sonido del canal elegido serán bloqueados.

Cuando se activa **BLOQUEAR PANEL DE CONTROL**, todos los botones del Panel Frontal serán desactivados, excepto el botón de encendido/apagado (**POWER**).

Cuando se selecciona **CLASIFICACIÓN DE CINE**, usted podrá bloquear varios tipos de películas y videocassetes basados en la clasificación de películas (ver página 108).

Cuando se selecciona **CLASIFICACIÓN DE TV**, usted podrá bloquear varios tipos de programas de TV basados en la clasificación de guía parental (ver página 109).

Use la **CLASIFICACIÓN PARA CANADÁ** para bloquear varios tipos de películas y programas de TV basados en los dos sistemas de clasificación usados en Canadá que usted crea sean inapropiados debido a su contenido (ver págs. 110-111).

Use **REGIÓN 5** para bloquear varios tipos de películas y programas de TV basados en sistemas de clasificación usados en U.S.A. que usted crea sean inapropiados debido a su contenido (ver pág. 112).

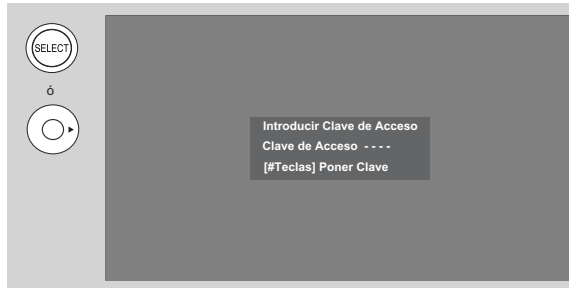

NOTA:

La opción **Región 5** funciona solamente para canales digitales.

Censuras

Clasificación de Cine

Use **CLASIFICACIÓN DE CINE** para prevenir ver cualquier película que usted crea inapropiada debido a su contenido.

1. Use los **CURSORES** ▲, ▼ para seleccionar la categoría de **CLASIFICACIÓN DE CINE** que usted desee bloquear.
2. Presione **SELECT** para bloquear la **CLASIFICACIÓN DE CINE** que usted ha elegido. Una vez seleccionada, por ejemplo **PG-13**, todas las películas clasificadas **PG-13** o más (**R**, **NC-17** y **X**) serán bloqueadas.
3. Presione **EXIT** para salir del menú o seleccione **CLASIFICACIÓN DE CINE** para regresar al menú anterior.



Tabla de Clasificación de Películas

SIN CLASIFICACIÓN	No contiene clasificación. Programas sin clasificación (NR) y no aplica (NA). La película no ha sido clasificada o no aplican clasificaciones.
G	Audiencia General. Para todas las edades.
PG	Se sugiere supervisión de padres. Algún material puede ser no apropiado para niños.
PG-13	Se requiere la supervisión de los padres. Algún material puede ser no apropiado para niños menores de 13 años.
R	Restringido. Menores de 17 años requiere la compañía de un padre o adulto.
NC-17	No se admite a nadie de 17 años o menor.
X	Solamente Adultos.

NOTA: 1. La clasificación de la película depende de la película que se esté viendo. Si la película no contiene una clasificación la TV no la bloqueará.

2. El bloquear programas **SIN CLASIFICACIÓN** puede bloquear programación de emergencia, deportes, noticias, anuncios de servicio público, programas religiosos y clima.

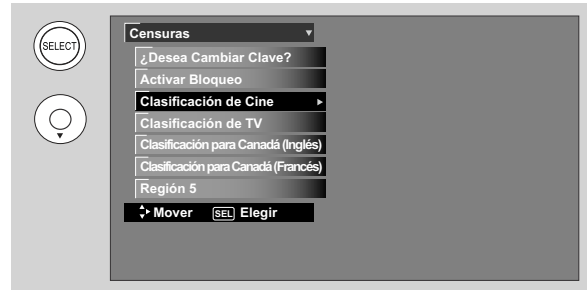
Censuras

Clasificación de TV

Use **CLASIFICACIÓN DE TV** para prevenir ver cualquier programa de TV que usted crea inapropiado debido a su contenido.

1. Use los **CURSORES** ▲, ▼ para seleccionar la categoría de **CLASIFICACIÓN DE TV** que usted desee bloquear.
2. Presione **SELECT** para bloquear la **CLASIFICACIÓN DE TV** que usted ha elegido.
3. Presione **EXIT** para salir del menú o seleccione **CLASIFICACIÓN DE TV** para regresar al menú anterior.



Tabla de Clasificación de Programas de TV

TV-Y	Para niños. Los temas y elementos en este programa son específicamente diseñados para una audiencia muy joven, incluyendo niños de 2-6 años.
TV-Y7	Dirigido a niños mayores. Los temas y elementos en este programa pueden incluir violencia cómica o ligeramente física, o puede asustar a niños menores de 7 años.
TV-G	Audiencia General. Contiene poca o ninguna violencia, sin lenguaje no apto para menores, y pocas o ninguna situación o diálogo de tipo sexual.
TV-PG	Se sugiere supervisión de los padres. Este programa puede contener lenguaje soez, violencia limitada, algunas situaciones y diálogo de tipo sexual.
TV-14	Se requiere supervisión de los padres. Este programa puede contener temas sofisticados, situaciones intensas de sexo, violencia más intensa y un mayor diálogo sugestivo.
TV-MA	Solo Audiencia Madura. Este programa puede contener temas maduros, lenguaje indecente, violencia gráfica y contenido sexual explícito.
FV	Violencia de Fantasía
V	Violencia Moderada
S	Escenas de Sexo
L	Lenguaje explícito
D	Diálogos Sugestivos

- NOTA:**
1. Si usted bloquea **TV-14D**, seguirá permitiendo los programas **TV-MA**; si bloquea **TV-14V**, automáticamente bloqueará los programas **TV-MAV**, pero seguirá permitiendo los programas **TV-MALS**. Esto significa que la TV bloqueará la violencia en **TV-14** y mayores (**TV-MA**), pero no el lenguaje y contenido sexual.
 2. Las clasificaciones de programas de TV dependen de la compañía televisora. Si el programa no está clasificado, la TV no lo bloqueará.

Censuras

Clasificación para Canadá (Inglés)

Use **CLASIFICACIÓN PARA CANADÁ (Inglés)** para prevenir ver cualquier tipo de película o programa de televisión en Canadá que usted crea inapropiada debido a su contenido.

1. Use los **CURSORES ▲, ▼** para seleccionar la categoría de **CLASIFICACIÓN PARA CANADÁ (Inglés)** que usted desee bloquear.
2. Presione **SELECT** para bloquear la **CLASIFICACIÓN PARA CANADÁ (Inglés)** que usted ha elegido. Una vez seleccionada, por ejemplo **C8+**, todas las películas y programas de TV clasificados **C8+** o mayor (**G, PG, 14+** y **18+**) serán bloqueados automáticamente.
3. Presione **EXIT** para salir del menú o seleccione **CLASIFICACIÓN PARA CANADÁ (Inglés)** para regresar al menú anterior.



Tabla de Clasificación de Canadá (Inglés)

C	Programación dirigida a niños menores de 8 años - Lineamientos sobre violencia: atención especial a los temas que pueden amenazar el sentido de seguridad y bienestar del niño. No existen escenas reales de violencia. Las escenas de comportamiento agresivo serán poco frecuentes y limitadas a representaciones que son claramente imaginarias, cómicas e irreales por naturaleza. Otros lineamientos de contenido: No habrá lenguaje ofensivo, desnudos o contenido sexual.
C8+	Programación generalmente considerada apta para niños de 8 años en adelante y que pueden ver solos - Lineamientos sobre violencia: La violencia no será mostrada como la única, preferida y aceptable manera de resolver los conflictos; o motivará a los niños a imitar actos peligrosos que puedan ver en televisión. Cualquier escena realista de violencia será poco frecuente, discreta, de baja intensidad y mostrará las consecuencias de los actos. Otros lineamientos de contenido: No habrá palabras altisonantes, desnudos o contenido sexual.
G	Audiencia General - Lineamientos sobre violencia: Contendrá muy poca violencia, ya sea física o verbal o emocional. Será sensible a temas que puedan asustar a niños menores, no mostrará escenas reales de violencia que minimicen o subestime los efectos de actos violentos. Otros lineamientos de contenido: Podrá haber expresiones inofensivas, no habrá palabras altisonantes, ni desnudos.
PG	Supervisión de padres - Programación dirigida para la audiencia general pero la cual puede no ser apta para niños menores. Los padres pueden considerar parte del contenido inapropiado para ser visto sin supervisión por niños entre los 8-13 años. Lineamientos sobre violencia: Muestras de conflictos y/o agresiones serán limitadas y moderadas; puede incluir violencia física, irreal, o sobrenatural. Otros lineamientos de contenido: Puede contener pocas palabras altisonantes o lenguaje ligeramente sugestivo. También puede contener escenas breves de desnudos.
14+	La programación contiene temas o contenido que puede no ser apto para menores de 14 años- Se advierte fuertemente a los padres tener discreción al permitir ver a pre-adolescentes y adolescentes. Lineamientos sobre violencia: Puede contener escenas intensas de violencia. Puede tratar con temas maduros y de la sociedad de una manera realista. Otros lineamientos de contenido: Puede contener escenas de desnudos y/o actividad sexual. Puede haber uso frecuente de palabras altisonantes.
18+	Adultos - Lineamientos sobre violencia: Puede contener violencia integral al desarrollo de la trama personaje o tema, dirigido para audiencia adulta. Otros lineamientos de contenido: Puede contener lenguaje gráfico y escenas explícitas de desnudo y/o sexo.

Censuras

Clasificación para Canadá (Francés)

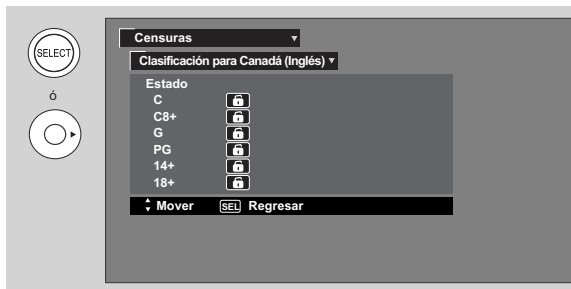
Use **CLASIFICACIÓN PARA CANADÁ (Francés)** para bloquear cualquier tipo de programa franco-canadiense cuyo contenido usted crea inapropiado de acuerdo a varias clasificaciones de programa.

1. Use los **CURSORES ▲, ▼** para seleccionar la categoría de **CLASIFICACIÓN PARA CANADÁ (Francés)** que usted desee bloquear.
2. Presione **SELECT** para bloquear la **CLASIFICACIÓN PARA CANADÁ (Francés)** que usted ha elegido. Una vez seleccionada, por ejemplo **8 ANS+**, todas las películas y programas de TV clasificados **8 ANS+** o mayor serán bloqueados automáticamente.
3. Presione **EXIT** para salir del menú o seleccione **CLASIFICACIÓN PARA CANADÁ (Francés)** para regresar al menú anterior.



Tabla de Clasificación de Canadá (Francés)

G	General - Programación dirigida para audiencia de todas las edades. No contiene violencia, o el contenido de violencia es mínimo o es mostrado apropiadamente con humor o en forma de caricatura o de una manera irreal.
8 ans +	8 + General - No se recomienda para niños menores de 8 años - Programación dirigida para una audiencia amplia pero que contiene violencia ligera u ocasional que puede perturbar a niños menores. Para niños menores de 8 años que no pueden diferenciar entre escenas reales e imaginarias se recomienda ver acompañado de un adulto.
13 ans +	Programación que puede ser no apta para niños menores de 13 años - Contiene pocas escenas violentas o una o más escenas violentas que pueden afectarlos. Se recomienda fuertemente ver con un adulto para niños menores de 13 años.
16 ans +	Programación no apta para niños menores de 16 años - Contiene escenas frecuentes de violencia o violencia intensa.
18 ans +	Programación solo para adultos - Contiene escenas constantes de violencia o escenas de extrema violencia.

Censuras

Región 5

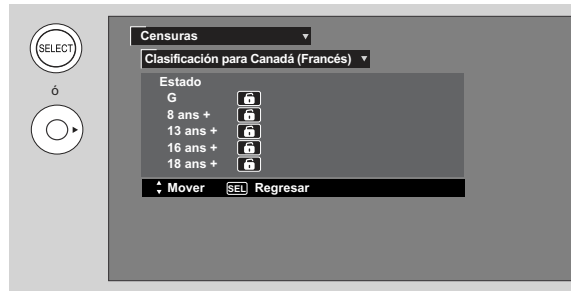
Use **REGIÓN 5** para prevenir ver cualquier película o programa que crea inapropiado debido a su contenido. Esta opción funciona solo para señal Digital ATSC.

Para poder activar la función **Región 5**, el canal digital ATSC recibido debe incluir los datos de la **Región 5**. Para ver si el canal tiene los datos de la **Región 5**, presione la tecla **INFO** en el control remoto. Como referencia vea la fig.1. Una vez que la TV ha recibido los datos de la **Región 5**, la opción **REGIÓN 5** en el menú **CENSURAS** mostrará los datos.

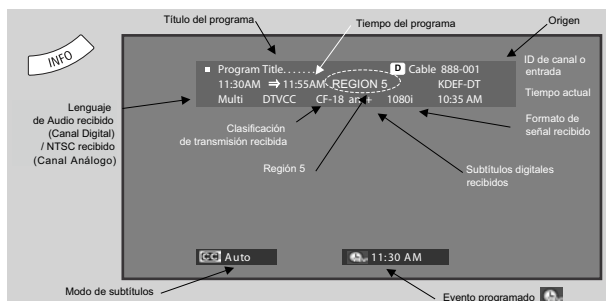
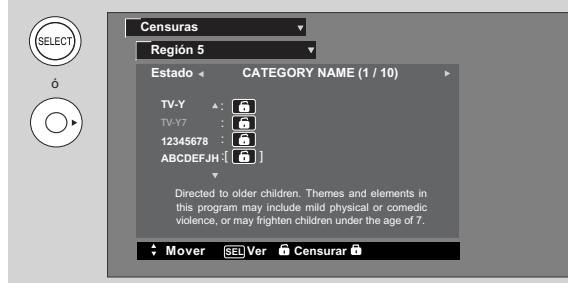
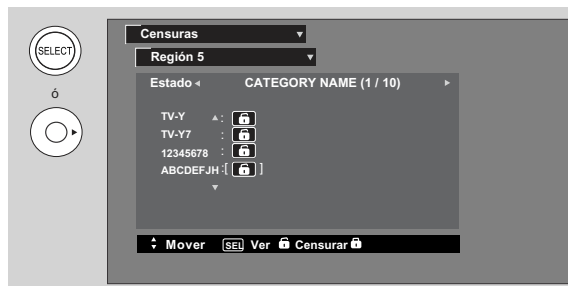

Fig. (1)

1. Use los **CURSORES** ▲, ▼ para seleccionar la categoría de **REGIÓN 5** que usted desee bloquear.
2. Presione **SELECT** para bloquear la categoría de **REGIÓN 5** que usted ha elegido. Una vez seleccionada por ejemplo **PG-13**, todas las películas clasificadas **PG-13** o mayor (**R**, **NC-17** y **X**) serán bloqueadas.
3. Presione **EXIT** para salir del menú o seleccione **REGIÓN 5** para regresar al menú anterior.



Clasificación de Región 5 (Ejemplo) :

G	Audiencia General. Para todas las edades.
PG	Se sugiere supervisión de padres. Algún material puede ser no apropiado para niños.
PG-13	Se requiere la supervisión de los padres. Algún material puede ser no apropiado para niños menores de 13 años.
R	Restringido. Menores de 17 años requiere la compañía de un padre o adulto.
NC-17	No se admite a nadie de 17 años o menor.
X	Solamente Adultos.
Y	Solamente Adultos.

Horarios

Horarios

Seleccione **HORARIOS** para programar su reloj y los tiempos de apagado automático y de modo Día/Noche.

1. Use los **CURSORES** ▲ o ▼ para resaltar la función que va a ser ajustada.
2. Presione el botón **SELECT** para elegir.



Fijar Reloj

El reloj deberá ser ajustado antes para poder usar la función **PROGRAMAR MODO DIA/NOCHE**

1. Use los **CURSORES** ◀, ▶, ▲, ▼ para resaltar y configurar el **HORARIO POR ZONA**.
2. Si usted lleva horario de verano, use los **CURSORES** para resaltar el cuadro de corrección de horario de verano y presione el botón de **SELECT** para elegir.
3. Use los **CURSORES** ◀, ▶, ▲, ▼ para resaltar y configurar la **FECHA** y **TIEMPO ACTUAL**, hora y minutos, AM o PM, MES, DIA, y AÑO.
4. Use los **CURSORES** ▲, ▼ para ajustar los valores.
5. Presione **SELECT** para fijar el **TIEMPO** y **FECHA**.
6. Presione **EXIT** para salir del menú o seleccione **HORARIOS** para regresar al menú anterior.

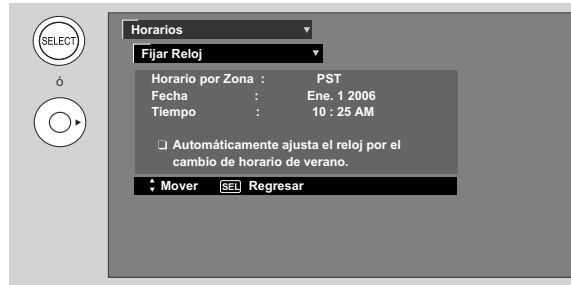

NOTA: 1. Cuando se selecciona **Automáticamente ajusta el reloj por el cambio de horario de verano**, la TV calculará automáticamente el ajuste del reloj para el horario de verano.

2. La TV hace un conteo de pulsos eléctricos para regular los **HORARIOS**. Cuando el cable de alimentación sea desconectado y conectado rápidamente, el reloj parará momentáneamente y la indicación del tiempo será lenta.

Horarios

Tiempo de Auto-Apagado

Seleccione esta función para configurar el **TIEMPO DE AUTOAPAGADO** desde 30 minutos hasta 3 horas (incrementos de 30 minutos).

1. Presione el **CURSOR** ► repetidamente para configurar el tiempo desde **0:00, 0:30, 1:00, 1:30, 2:00, 2:30** y **3:00**.

NOTA: La información del reloj de apagado automático aparecerá un minuto antes de apagarse el televisor.

Programar Modo Día/Noche

Seleccione esta función para activar y configurar el **MODO DE IMAGEN DIA/NOCHE** de su TV automáticamente. Esta función no está disponible hasta que se fije el reloj.

1. Use los **CURSORES** para resaltar las opciones del menú **PROGRAMAR MODO DIA/NOCHE**
2. Presione el botón **SELECT** para activar la opción.
3. Use los **CURSORES** para seleccionar **MODO DIA (NORMAL) ON** y programar su tiempo.
4. Use los **CURSORES** para seleccionar **MODO DIA (DINAMICO) ON** y programar su tiempo.
5. Use los **CURSORES** para seleccionar **MODO NOCHE ON** y programar su tiempo.
6. Presione **EXIT** para salir del menú o seleccione **PROGRAMAR MODO DIA/NOCHE** para regresar al menú anterior.

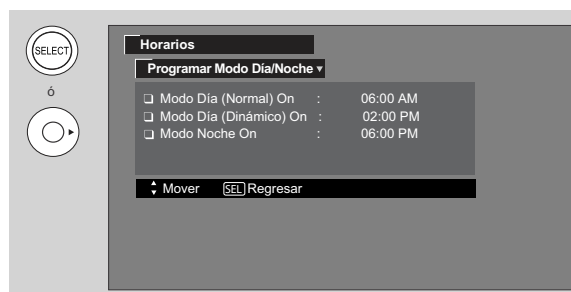

Horarios

Configurar Eventos

Esta función automáticamente operará las reservaciones de programas de su televisor LCD. Si el reloj no ha sido configurado, usted no podrá usar esta función y la pantalla de la derecha aparecerá. El mensaje en la pantalla desaparecerá después de 3 segundos, entonces la pantalla automáticamente irá al modo de fijar el reloj (vea pág. 113).

1. Use los **CURSORES** ▲,▼ para resaltar **EVENTO 1**, **EVENTO 2**, **EVENTO 3**, **EVENTO 4** y luego presione el botón **SELECT** para elegir.
2. Use los **CURSORES** ►,▲ o ▼ para resaltar y elegir **TIEMPO DE INICIO HORA/MINUTO**.
3. Use los **CURSORES** ►,▲ o ▼ para resaltar y elegir **TIEMPO DE INICIO AM/PM**.
4. Use los **CURSORES** ►,▲ o ▼ para resaltar y elegir **TIEMPO DE FINALIZACION HORA/MINUTO**.
5. Use los **CURSORES** ►,▲ o ▼ para resaltar y elegir **TIEMPO DE FINALIZACION AM/PM**.
6. Use el **CURSOR** ► para resaltar el **MES**.
7. Use el **CURSOR** ▲ para seleccionar el **MES** o el **CURSOR** ▼ para elegir **DIARIO**, **SEMANAL-DOMINGO A LUNES**. Use el **CURSOR** ◀ para regresar al **MES**.
8. Use los **CURSORES** ►,▲ o ▼ para resaltar y elegir el **DIA** del **MES**.
9. Use los **CURSORES** ►,▲ o ▼ para resaltar y elegir el **AÑO**.
10. Use los **CURSORES** ►,▲ o ▼ o botones **NUMÉRICOS** para configurar el canal al cual la TV se sintonizará.
11. Una en el recuadro significa que el Evento está habilitado.

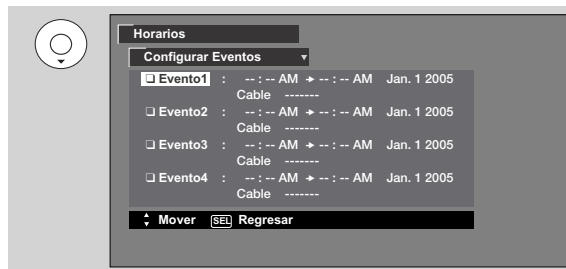
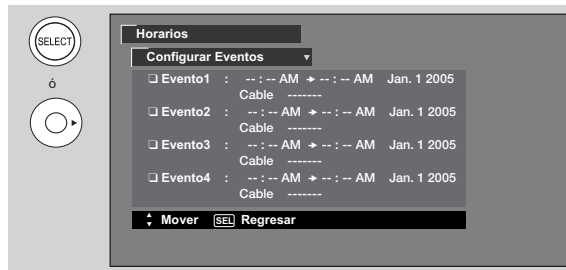
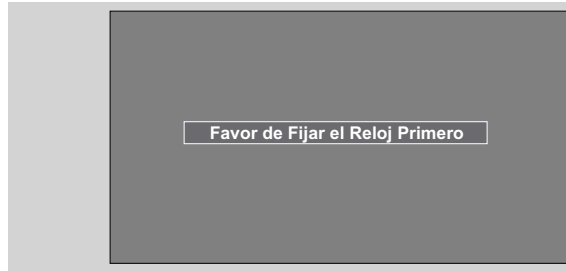

- NOTAS:**
1. Cuando el botón **INFO** es presionado, el icono de **Configurar Eventos** solo desplegará el tiempo de autoapagado de la fecha actual.
 2. El **Tiempo de apagado** solo se activará si la TV fue encendida por el **TIEMPO DE ENCENDIDO** y no se realizó alguna operación del menú después de este tiempo. Si usted cambia el canal u opera el menú después de que se activó el tiempo de encendido, el **TIEMPO DE APAGADO** se desactivará.



PRECAUCION: No utilice su TV como un disuasivo cuando no se encuentre en casa por medio de los **TIEMPOS DE ENCENDIDO Y APAGADO**. Por seguridad, la TV deberá ser apagada cuando usted no vaya a estar en casa.

Configurar

Seleccione **CONFIGURAR** cuando configure su TV por primera vez.

1. Use los **CURSORES** ▲, ▼, ◀ o ▶ para seleccionar el submenú de su elección.
2. Presione el botón **SELECT** para elegir.

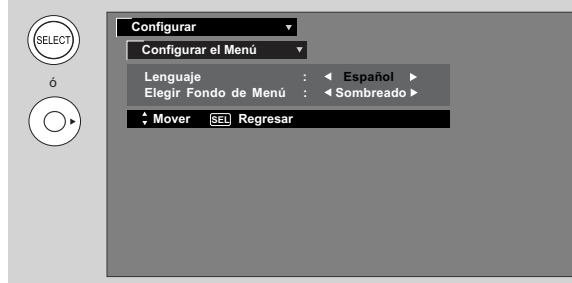
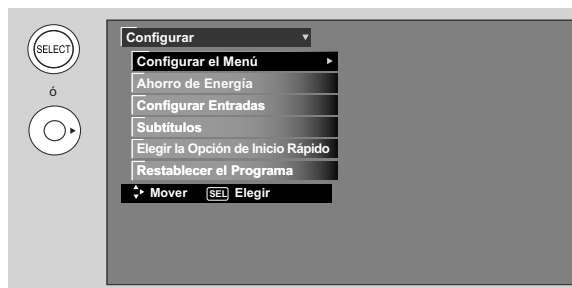
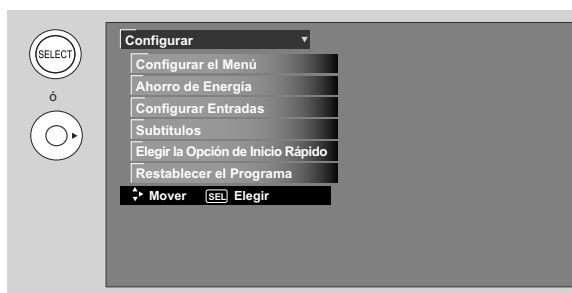

Configurar el Menú

Configure el Lenguaje y fondo del Menú en pantalla.

Lenguaje

Esta función le permitirá seleccionar cualquiera de tres diferentes lenguajes para todos los despliegues de menús en pantalla.

1. Use los **CURSORES** ◀ o ▶ para seleccionar el lenguaje de su elección.
2. Presione **EXIT** para salir del menú o seleccione **CONFIGURAR EL MENÚ** para regresar al menú anterior.

Configurar

Elegir Fondo de Menú

Esta función le permite elegir uno de dos tipos de fondos.

1. Use los **CURSORES** ▲ o ▼ para resaltar **ELEGIR FONDO DE MENÚ**. Use los **CURSORES** ◀ o ▶ para seleccionar Sombreado o Sólido.
2. Seleccione **SÓLIDO** para un fondo negro (ninguna imagen puede ser vista detrás del menú). Seleccione **SOMBREADO** para mostrar un fondo semitransparente.
3. Presione **EXIT** para salir del menú o seleccione **CONFIGURAR EL MENÚ** para regresar al menú anterior.

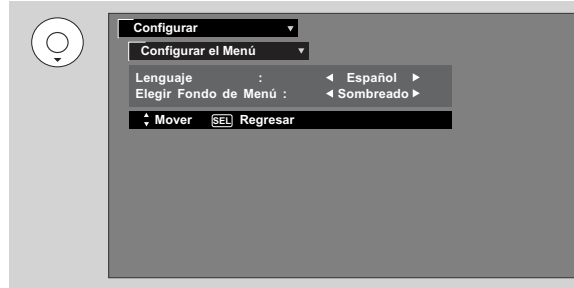

Configurar el Ahorro de Energía

Esta función ayuda a incrementar la vida de la lámpara.

Potencia de la Imagen

Esta función le permite elegir la reducción del consumo de potencia basado en 3 niveles (min., medio y max).

1. Presione los botones de **CURSOR** ◀ ó ▶ para seleccionar los modos Max, Med or Min.

Ahorro de Energía Automático

Use esta función para apagar el televisor automáticamente cuando no se detecta una señal de video por 12 seg.

1. Presione los botones de **CURSOR** ◀ ó ▶ para seleccionar Si ó No.

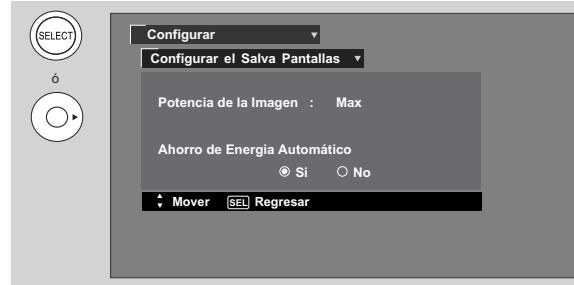
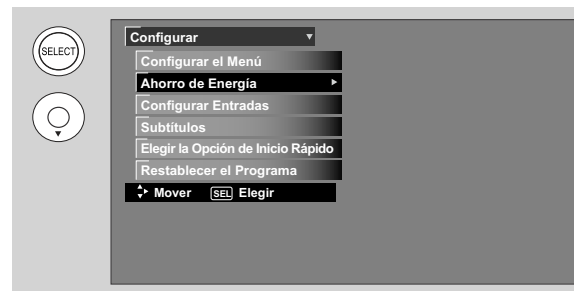

NOTA: Esta opción solo funciona en las Entradas 1, 2, 3, Frontal y HDMI 1, 2, Frontal.

Configurar

Configurar Entradas

Use esta función para dar un nombre a cualquiera de las entradas de video

1. Presione los **CURSORES ▲** o **▼** para resaltar las entradas de video.
2. Presione los **CURSORES ◀** o **▶** para seleccionar sus preferencias.

NOTA: Las entradas en gris (Skip) ú ocultas (Hide) no están habilitadas en la selección de **ENTRADAS**.

ENTRADA 3 Auto Link

Use esta función para encender automáticamente la TV y seleccionar la **ENTRADA 3** cuando se detecte una señal de video en la **ENTRADA 3**.

1. Use los **CURSORES ▲, ▼, ◀** o **▶** para resaltar y seleccionar las opciones de **AUTO LINK** de su preferencia.

Automático

Cuando **AUTOMÁTICO** es seleccionado, la TV encenderá y cambiará a **ENTRADA 3** automáticamente, cuando el dispositivo conectado a la **ENTRADA 3** sea encendido. Esto es muy conveniente cuando se desea ver una película usando su VCR, Reproductor de DVD o Laserdisc.

Off

Seleccione **OFF** para desactivar esta función.

2. Presione **EXIT** para salir del menú o seleccione **CONFIGURAR ENTRADAS** para regresar al menú anterior.

NOTA: 1. Una vez que la TV ha sido encendida usando **AUTO LINK**, esta función debe ser reiniciada antes de usar **AUTO LINK** otra vez. Para hacer esto, apague su VCR, Reproductor de DVD o Laserdisc. Esta función está ahora reiniciada y encenderá su TV como se describió anteriormente.

2. Si no se presiona una tecla del control remoto después que la TV es encendida por **AUTO LINK**, la TV se apagará automáticamente al cabo de 3 horas.

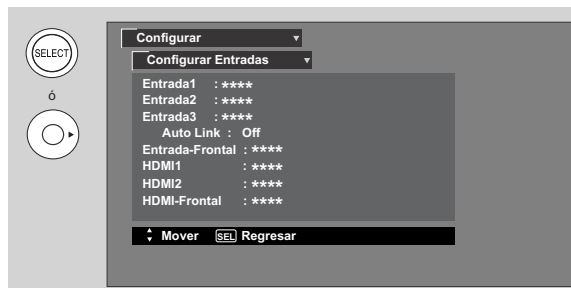
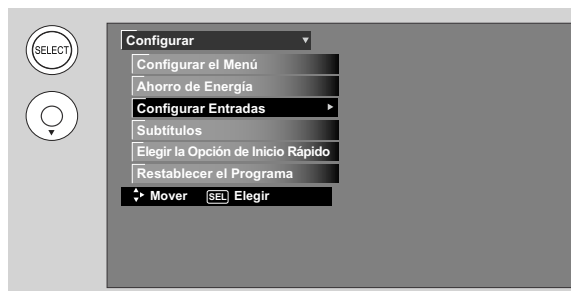

Configurar

Subtítulos

Los Subtítulos son los diálogos, la narración, y/o los efectos de sonido de un programa de TV o video los cuales son desplegados en la pantalla de TV. Su guía de programación local identifica estos programas **CC** ó **CC**.

1. Use los **CURSORES** ◀, ▶, ▲ y ▼ para resaltar y seleccionar la función a cambiar.
2. Presione **EXIT** para salir del menú o seleccione **SUBTÍTULOS** para regresar al menú anterior.

Mostrar Subtítulos:

ON/OFF cambia el **CC** encendido/apagado.
AUTOMÁTICO cambia el **CC** a encendido cuando se activa el Volumen Bajo ó Volumen Apagado.

Subtítulos Análogos

Configura los subtítulos para programación análoga. Esta le ayudará a elegir y configurar el modo y el canal disponible.

Modo:

SUBTÍTULOS es para el programa que usted está viendo.
TEXTO es para información adicional tal como reportes de noticias o guía de programas de televisión. Esta información cubre toda la pantalla y no es posible ver un programa de televisión. **TEXTO** puede no estar disponible con todos los programas **CC**.

Canal:

- 1 es usado para el lenguaje primario (usualmente inglés).
- 2 es algunas veces usado para un segundo lenguaje (puede variar por región).
- 3 es algunas veces usado para un tercer lenguaje (puede variar por región).
- 4 es algunas veces usado para un cuarto lenguaje (puede variar por región).

Subtítulos Digitales

Configura los subtítulos para programación digital. Esta le ayudará a elegir y configurar el lenguaje, fuente, tamaño y estilo de los subtítulos digitales.

1. Use los **CURSORES** ◀, ▶, ▲ o ▼ para resaltar y seleccionar la opción de Subtítulos Digitales deseada.
2. Presione **EXIT** para salir del menú o seleccione **SUBTÍTULOS** para regresar al menú anterior..

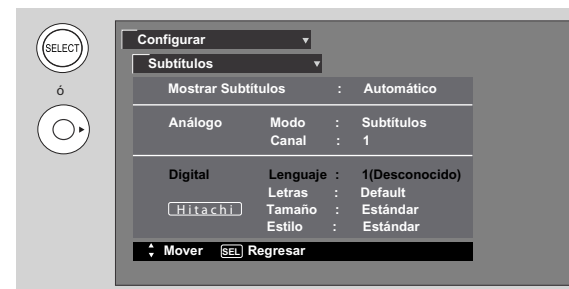
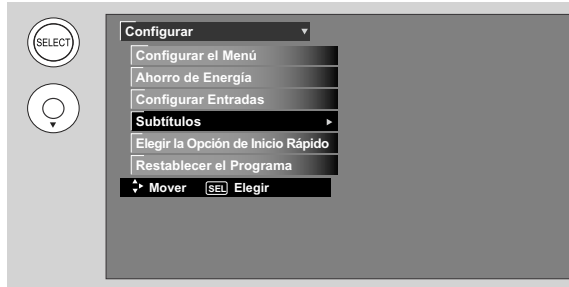

- NOTA:**
1. Algunos tipos de Subtítulos Digitales no se desplegaran en esta TV.
 2. MOSTRAR SUBTÍTULOS no funcionará con señales de entrada 480p, 720p, o 1080i a través de las entradas por **COMPONENTE** Y-PbPr.
 3. El estilo de letra de los Subtítulos Digitales en ocasiones es diferente a la de los Subtítulos Análogos.
 4. La disponibilidad y el contenido de los Subtítulos Análogos y Digitales depende de la emisora de TV. Los Subtítulos Análogos están disponibles cuando el icono es mostrado en pantalla.
 5. El Lenguaje de los Subtítulos Digitales no estará disponible (letras en gris) al recibir programación análoga.

Elegir la Opción de Inicio Rápido

Esta función le permite seleccionar entre las opciones de **INICIO RÁPIDO**. Seleccione **ON** para poder ver los canales (Análogos y Digitales) más rápido al encender la TV.

Seleccione **OFF** para ahorrar electricidad. Al seleccionar **ON** en la función **INICIO RÁPIDO** se activarán los circuitos de los sintonizadores cuando la TV esta en "modo de espera" comunmente conocido "apagado". Esto le permitirá sintonizar rapidamente los canales al encender la TV.

Las señales digitales algunas veces cambian, esta función vigilará cualquier cambio y preparará la TV para presentar rapidamente una imagen. Una pequeña cantidad de electricidad es usada para vigilar continuamente las señales cuando esta función esta activada.

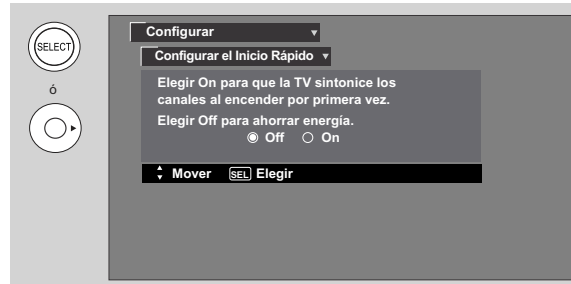
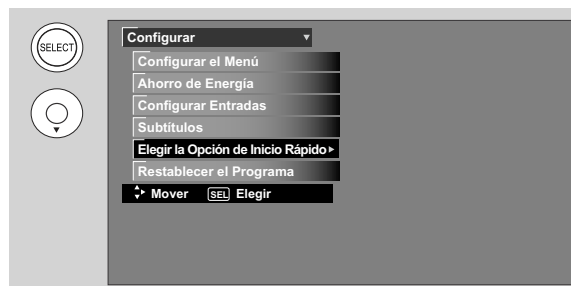

Restablecer el Programa

Esta función muestra la información del software y el sencillo procedimiento de actualización. Esta función permite al software de la TV ser actualizado usando una tarjeta de memoria **MMC/SD**. Si una actualización de software es requerida, **HITACHI** le notificará y proveerá una tarjeta de memoria.

Como requisito para recibir una notificación escrita y la tarjeta de memoria, por favor llene con sus datos y regrese la tarjeta de garantía.

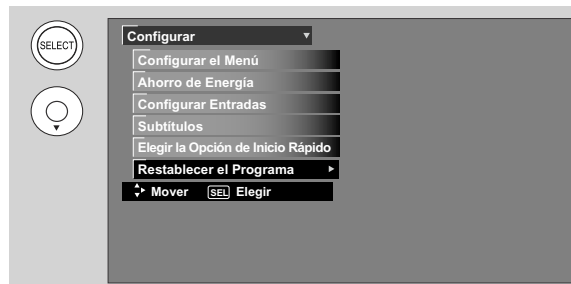

1. Inserte la tarjeta **MMC/SD**.
2. Presione los **CURSORES ▲** o **▼** para resaltar **ACTUALIZAR AHORA**
3. Presione el botón **SELECT** para seleccionar la función é iniciar la actualización.
4. Desconecte la línea de AC cuando la actualización este completa.

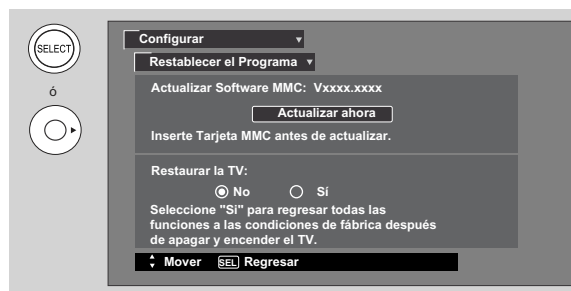

NOTA: Cualquier interrupción de energía durante el proceso de actualización cancelará el proceso. Cuando esto ocurra, repita el procedimiento.

Restaurar la TV

Esta función le permite restaurar todas las funciones de la TV a sus condiciones originales de fábrica la próxima vez que se apague y se encienda la TV al quitar la Alimentación Principal.

1. Use los **CURSORES ▲, ▼** para resaltar la función.
2. Presione el botón **SELECT** o el **CURSOR ►** para seleccionar **Restaurar la TV**.
3. Use el **CURSOR ▼** para acceder a las opciones de la función **Restaurar la TV**.
4. Seleccione la opción "SI" para restaurar todas las funciones de la TV la proxima vez que se apague y se encienda la TV al quitar la Alimentación Principal.

NOTA: 1. Si la opción "Si" es seleccionada, **TODAS LAS FUNCIONES DE LA TV seran restauradas a sus condiciones originales de fábrica la proxima vez que se apague y se encienda la TV usando el interruptor principal o presione el botón de Power durante 5 segundos.**

2. Cuando la Opción de Inicio Rápido ha sido activada , la opción **Restaurar la TV** no funcionará a menos que la clavija ha sido desconectada una vez o al presionar el botón de Power durante 5 segundos.

Girar Pantalla

Girar Pantalla

Esta función controla la base giratoria automática. Le permite al cliente girar la pantalla hacia la izquierda o derecha utilizando el control remoto. Esta función solo está disponible en el menú cuando la base giratoria está conectada (ver pág. 70).

1. Use los **CURSORES** ◀ o ▶ para activar o desactivar la función de Girar Pantalla.
Antes de controlar la base giratoria automática favor de salir del menú en pantalla.
2. Presione el **CURSOS** ▶ para girar la pantalla hacia la derecha.
3. Presione el **CURSOS** ◀ para girar la pantalla hacia la izquierda.
4. Libere el **CURSOS** para detener la rotación.



- NOTA:**
1. La base giratoria motorizada tiene un radio de rotación máxima de 30° (izquierda y derecha).
 2. No coloque ningún objeto en la trayectoria de la pantalla cuando utilice la función Girar Pantalla.
 3. Antes de utilizar la base giratoria automática, favor de asegurarse que la trayectoria de la pantalla está libre de dedos, manos y cualquier otras partes del cuerpo para prevenir cualquier daño o lesión.

Cuidados de su Televisión y Solución de Problemas

PERMITIDO

Desempolva la pantalla y gabinete con una toalla suave.

Limpie la pantalla con una toalla ligeramente húmeda en agua tibia y seque con una toalla seca Jabón de reacción media puede ser usado si la pantalla está en extremo sucia.

Coloque su Televisión de LCD lejos de calor extremo, humedad, y lugares con mucho polvo.

Remueva la conexión de la toma de corriente en la pared si su Televisión no está en uso por un periodo largo de tiempo, por ejemplo cuando usted sale de vacaciones.

NO PERMITIDO

No limpie su pantalla con limpiadores fuertes, no use productos para pulir o toallas tratadas con químicos.

No coloque productos de vinil o hule o papel celofán en su Televisión de LCD.

No toque la pantalla con frecuencia.

No exponga el control remoto a golpes tales como dejarlo caer en el piso, etc. Esto puede resultar en daños en partes de precisión.

Evite colocar el control remoto en lugares de alta humedad o dejar que se moje. No lo deje cerca o encima de un aparato de calefacción. Calor o humedad excesiva puede causar que la unidad cese de operar.

Cuando las baterías se desgastan, la operación del control remoto se vuelve errática o posiblemente se detenga por completo. Reemplace las baterías usadas con nuevas baterías de tamaño "AA" tan pronto como sea posible.

El exponer la pantalla a la luz directa del sol o al calor por un tiempo prolongado puede causar daño a la pantalla de LCD.

Solución de Problemas

Su Televisión de LCD **HITACHI** incorpora avanzada tecnología de protección contra sobrevoltaje diseñada para proteger contra daño de componentes ó circuitos a causa de un sobrevoltaje externo o interno.

SI SU TELEVISOR TIENE PROBLEMAS PARA ENCENDER, FAVOR DE SEGUIR ESTE PROCEDIMIENTO:

1. Presione el botón de encendido (Power Switch) una sola vez.
2. Si aun no enciende, espere 30 segundos. y presione el botón de encendido otra vez.
3. Si aun no enciende, desconecte la línea de AC del contacto y espere 30 segundos para conectarla de nuevo. Presione el botón de encendido otra vez.

Esta tecnología de protección debe proporcionar muchos años de entretenimiento duradero de su Televisor de LCD **HITACHI**.

SÍNTOMAS	REVISE ESTOS PUNTOS E INTENTE ESTOS AJUSTES										
	1	2	3	4	5	6	7	8	9	10	11
Sin imagen, sin sonido	●	●	●	●	●	●	●	●	●	●	●
Buen sonido, mala imagen	●			●	●	●	●	●	●	●	●
Buena imagen, mal sonido	●			●	●	●	●	●	●	●	●
Imagen borrosa	●			●	●	●	●	●	●	●	●
Lineas o rayas en la imagen				●	●	●	●	●	●	●	●
Mala recepción en algunos canales				●	●	●	●	●	●	●	●
Imagen corriendo verticalmente				●				●			
Sin color	●			●	●	●	●	●			●
Color pobre	●			●	●	●	●	●			●

Problemas de Recepción



RUIDO DE ENCENDIDO:

Puntos negros o rayas horizontales pueden aparecer, la imagen puede variar ó moverse. Usualmente causado por interferencia de un sistema de arranque de un auto, lámparas de neón, taladros eléctricos, y otros aparatos eléctricos.



IMÁGENES FANTASMAS:

Imágenes fantasmas son causadas por señales de televisión siguiendo dos rutas distintas. Una es de incidencia directa y la otra es reflejada en edificios altos, montañas u otros objetos. Cambiar la dirección o posición de la antena puede mejorar la recepción. Imágenes fantasmas también pueden ser causadas por defectos del sistema de la antena tales como cables sin blindaje o al conectar varios aparatos a la misma antena sin usar divisores múltiples de antena.



NIEVE:

Si su receptor esta ubicado en el límite de cobertura de una estación de TV donde la señal es débil, su imagen puede estar empañada con la apariencia de pequeños puntos. Cuando la señal es extremadamente débil, puede ser necesario instalar una antena especial para mejorar la imagen.



INTERFERENCIA DE FRECUENCIAS DE RADIO:

• INTERFERENCIA DE FRECUENCIAS DE RADIO:

La interferencia produce ondas o rayas diagonales, y en algunos casos, causa pérdida de contraste en la imagen.

• PREVENCIÓN DE OBSTACULOS PARA RECEPTORES DE RADIO

Esta televisión ha sido diseñada conforme a las normas de la FCC para aparatos de Clase B . Esto para prevenir problemas a los receptores de Radio. Si esta televisión causa problemas a un receptor de Radio siga los siguientes pasos:

- Mantenga la televisión lejos del Radio.
- Ajuste la antena del Radio con el fin de no recibir interferencia.
- El cable de la antena del Radio debe mantenerse lejos de la televisión.
- Use cable coaxial para la antena.

Usted puede comprobar si esta televisión interfiere en los receptores de Radio apagando todos los equipos excepto la TV. Si usted encuentra un problema al recibir el Radio al estar usando la television, siga las instrucciones mencionadas arriba.



IMAGEN DIGITALIZADA Ó CUADRICULADA(ENTRADA DIGITAL):

Imagen cuadriculada puede aparecer en una parte o en toda la pantalla. Usualmente causado por interferencia de un sistema de arranque de un auto, lámparas de neón, taladros eléctricos, y otros aparatos eléctricos.



IMAGEN OSCURA:

Al recibir canales usando una antena y esta señal sea muy débil, la imagen aparecerá oscura, puede ser necesario mejorar su sistema de antena.

NOTA: La televisión puede generar distorsión de sonido en dispositivos externos tales como una radio. Favor de separar el equipo de radio del equipo de televisión y ponerlo a una distancia considerable.

INFORMACIÓN DE LA AGENCIA REGULADORA

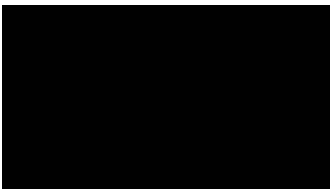
Declaración de la FCC (Federal Communications Commission)

Este equipo ha sido probado y ha demostrado cumplir con las limitaciones para los dispositivos digitales Clase B, de conformidad con el Apartado 15 de las Normas de la FCC. Estos límites han sido diseñados para proporcionar una protección razonable contra las interferencias perjudiciales en una instalación residencial. Este equipo genera, utiliza y puede radiar energía radioeléctrica, y si no se instala y utiliza de acuerdo con las instrucciones, puede causar interferencias perjudiciales en las comunicaciones por radio. Sin embargo, no existe ninguna garantía de que las interferencias no se produzcan en una instalación particular. Si este equipo causa interferencias perjudiciales en la recepción de la radio o televisión, lo que se puede determinar apagando y encendiendo el equipo, al usuario se le recomienda intentar corregir la interferencia tomando una o más de las siguientes medidas:

- Cambie la orientación o el lugar de instalación de la antena.
- Aumente la separación entre el equipo y el receptor.
- Conecte el equipo a una toma de corriente diferente de aquella a la que está conectado el receptor.
- Consulte a su proveedor o solicite la ayuda de un técnico con experiencia.

Información de la FCC

Este dispositivo cumple con el Apartado 15 de las normas de la FCC. El funcionamiento está sujeto a las dos condiciones siguientes: (1) Este dispositivo no deberá causar interferencias perjudiciales y (2) Este dispositivo deberá aceptar cualquier interferencia que reciba, incluyendo la interferencia que pueda causar un funcionamiento no deseado.

Modificaciones

La FCC requiere que se notifique al usuario que cualquier cambio o modificación hecha a este dispositivo que no haya sido aprobada expresamente por Hitachi America, Ltd. Home Electronics Division puede anular la autoridad del usuario para operar este equipo.

Cables

Las conexiones a este dispositivo deben ser hechas con cables blindados con conectores metálicos RFI/EMI para estar en cumplimiento con las Normas y Regulaciones de la FCC.

Cualquier cable que se incluya con el equipo debe ser reemplazado con cables idénticos para asegurar el cumplimiento de las Normas de la FCC. Ordene repuestos Hitachi para reemplazar sus cables.

Nota

Este receptor de televisión despliega subtítulos ( ó ), en acuerdo con los párrafos 15.119 y 15.122 de las normas de la FCC.

INFORMACIÓN REGULATORIA DE LA AGENCIA DE LA INDUSTRIA DE CANADÁ

Aparato de Televisión compatible con cable- Télévision câblocompatible, Canada.

Funciones y Especificaciones

Funciones:

- Nuevo Panel de LCD Full HD 1080P
- Nuevo y Fácil de Usar (3-Lenguajes) Menú en Pantalla.
- Censuras por Región
- Control Remoto Preprogramado.
- Ahorro de Energía: Encen./Apag. por Detección de Señal
- Realce de Imagen
- Identificación de la Señal de Entrada
- Compatible con HDMI (High Definition Multimedia Interface)(HighBandwidth Digital Content Protection V1.1)
- Subtítulos (Análogos y Digitales)
- Temporizador de Eventos y Autoapagado
- Tecnología  DIGITAL
- Control de Sincronía del Audio

Video:

- Resolución del panel:1920 x 1080
- Tecnología IPS (In Plane Switching Technology)
- Amplio Ángulo de Visión: más de 178°
- Diferentes Modos de Temperatura de Color : Alta, Media, Estándar y Blanco/Negro.
- Modos Múltiples de Despliegue en Pantalla(Aspectos)
- (4:3 Standard/4:3 Expanded/4:3 Zoom 1/ 4:3 Zoom 2/16:9 Standard1/Standard2/16:9 Zoom)1
- Filtro 3D Y/C de 4MB 10-bit
- Modos de Imagen: Día(Normal), Día(Dinámico) y Noche

Entradas:

- Alimentación AC 120V, 60Hz
- Consumo de Potencia
Potencia Promedio : L47S601 - 303 W
. L42S601 - 215 W
Potencia Máxima : L47S601 - 303 W, 2.55 A
. L42S601 - 215 W, 1.85 A
- Impedancia de Entrada de Antena 75 Ohm
- Cobertura de Canales 191ch.
- Banda VHF. 2 ~ 13
- Banda UHF. 14 ~ 69
- Banda CATV Mid A-5 ~ A-1
. A-I
SuperBanda. J-W
HiperBanda W+1 - W+28
UltraBanda W+29 - W+94
- Sistema de Televisión NTSC Standard
ATSC Standard (8 VSB, 64-QAM, 256-QAM)
- Video 1.0Vp-p, 75 Ohm
- S-Video
Luminancia (Y) 1.0Vp-p, 75 Ohm
Crominancia (C) 0.286Vp-p, 75 Ohm
- Video por Componentes
Luminancia (Y) 1.0Vp-p, 75 Ohm
Crominancia (Pb/Pr) 0.7Vp-p, 75 Ohm
- Impedancia de Entrada de Audio 270k Ohm
- Nivel promedio de entrada 470mVrms
- HDMI. (19 PIN)

Salidas:

- Video 1.0Vp-p. 75 Ohm
- Audio 470mVrms, 1k Ohm
- Salida Óptica (Audio Digital) 1 Conector Óptico

Audio:

- MTS Stereo/SAP
- Bass Boost
- Sonido Surround
- 20W
- Volumen Bajo (50%)

Accesorios Incluidos:

- Control Remoto
- Baterías (AA)
- Cable de AC de 6'
- Base Giratoria (ensamblada)
- Conector para Base Giratoria

Accesorios Opcionales:

- Para Modelos de los E.U.A.:Por favor, accese nuestro sitio web: www.hitachi.us/tv
- Para modelos de Canadá: Por favor, accese nuestro sitio web: www.hitachi.caltv

ENTRADAS/SALIDAS

- Video por Componentes Y, Pb,Pr 2
- Video compuesto 4
- S-Video 1
- Entrada de Antena(RF). 1
- Salida de Audio. 1
- Salida de Monitor. 1
- Salida Óptica 1
- Ranura de Tarjeta de Actualización. 1
- HDMI 3
- Interfase RS232C 1

ESPECIFICACIONES

- Separación entre Pixeles
L47S601. 0.5415(horiz.) x 0.5415(vert.) mm.
L42S601. 0.4845(horiz.) x 0.4845(vert.) mm.
- Clase FCC: B para Productos de Consumo
- Requerimientos de Potencia 108-132VAC, 60Hz
- Temperatura de Operación. 41°F a 95°F

¹ La disponibilidad del modo de despliegue varia debido a la señal de entrada.

Las TV's HDTV despliegan HDTV solo cuando una fuente HDTV esta disponible. Especificaciones, pesos, y dimensiones estan sujetas a cambio sin notificación previa. Favor de acceder a www.hitachi.us/tv para especificaciones y dimensiones detalladas que le puedan servir para su instalación.

UltraVision Digital es una marca registrada de Hitachi Home Electronics (America), Inc.



COPYRIGHT © 1999-2007 MONTAVISTA SOFTWARE, INC. ALL RIGHTS RESERVED.

 HDMI, el logo HDMI logo y High-Definition Multimedia Interface son marcas registradas de HDMI Licensing LLC.

*Fabricada bajo licencia de Dolby Laboratories. "Dolby" y el símbolo doble-D son marcas registradas de Dolby Laboratories.

Dimensiones

Modelos de 47" (Incluyen Base) Peso (lbs./kg): 74.3/33.7

Modelos de 42" (Incluyen Base) Peso (lbs./kg): 61.3/27.8

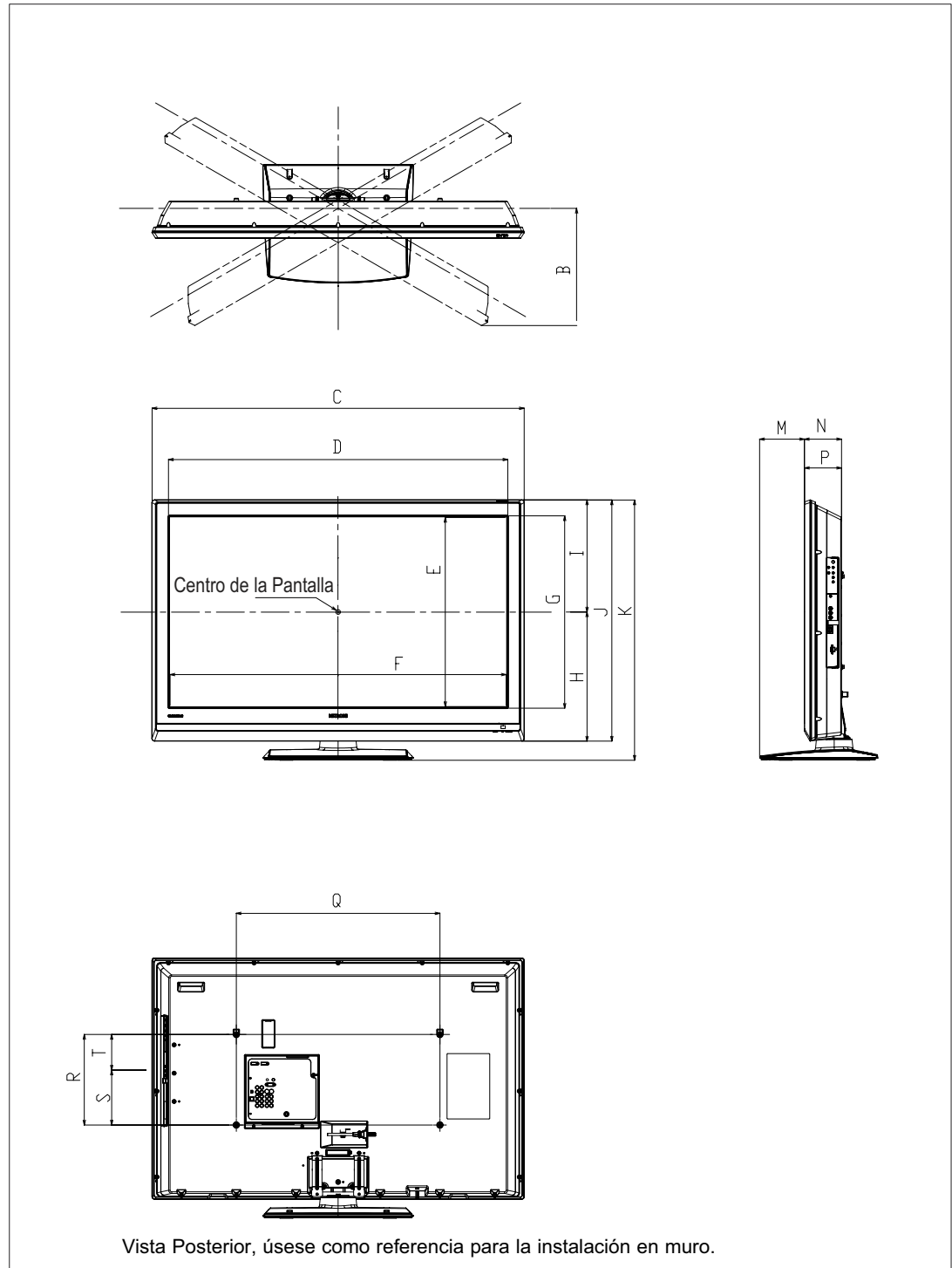

47"

Unidades	A	B	C	D	E	F	G	H	I	J	K	L	M	N	O	P	Q	R	S	T
Pulgadas	11-1/16	14-1/4	45-5/16	41-5/16	23	40-15/16	23-7/16	15-3/4	13-5/8	29-3/8	31-11/16	2-5/16	5-7/16	4-1/2	4-7/16	4-1/2	24-13/16	11	6-11/16	4-5/16
mm	281.05	362.26	1151.30	1050	584.82	1039.68	595	399.40	346.60	746	805	59.10	138.70	114.70	112.08	114.18	630	280	169.80	110.20

42"

Unidades	A	B	C	D	E	F	G	H	I	J	K	L	M	N	O	P	Q	R	S	T
Pulgadas	10	13-3/16	41	36-13/16	20-9/16	36-5/8	20-3/4	14-1/2	12-7/16	26-15/16	29-1/4	2-5/16	5-7/16	4-1/2	4-7/16	4-1/2	24-13/16	11	6-11/16	4-5/16
mm	253.56	334.77	1041.70	934.5	523	930.20	527	368.40	315.60	684	743	59.10	138.70	114.70	112.10	114.18	630	280	169.80	110.20

HITACHI

Inspire the Next

Servicio a Clientes

Para localizar un Centro de Servicio Autorizado **HITACHI** en los Estados Unidos y Canadá

Llame Gratis

las 24 horas del día, los 7 días de la semana

1-800-HITACHI
(1-800-448-2244)



HITACHI AMERICA, LTD.
HOME ELECTRONICS DIVISION

HITACHI ha hecho el máximo esfuerzo para asegurarle horas y horas de funcionamiento libre de problemas; sin embargo, en caso de requerir servicio, **HITACHI** ha establecido una Red de Centros de Servicio en los 50 estados del país y Puerto Rico. Cada centro le proporcionará asistencia rápida y segura. Nuestras operadoras lo guiarán directamente al Centro de Servicio Autorizado **HITACHI** más cerca de usted. Solo presente la factura y/o recibo de compra al Centro de Servicio Autorizado Hitachi, donde se le proporcionará servicio de acuerdo con los términos establecidos en la garantía o la guía de operación del televisor.

Si tiene dudas o preguntas acerca de la garantía, servicio, operación o asistencia técnica, favor de contactarnos por correo a:

Hitachi America, LTD.
Home Electronics Division
900 Hitachi Way
Chula Vista, CA 91914-3556

HITACHI CANADA, LTD.
DIGITAL MEDIA DIVISION

Si tiene dudas o preguntas acerca de la garantía, servicio, operación o asistencia técnica, favor de contactarnos en:

Canadá: 1-800-HITACHI (1-800-448-2244)

Lunes a Viernes (EST).....9:00am – 7:00pm
Sábado (EST)9:00am – 5:00pm

Pour de plus amples renseignements sur le service durant la période couverte par la garantie, sur le fonctionnement ou pour de l'assistance technique communiquez avec:

Au Canada: 1-800-HITACHI (1-800-448-2244)

Lundi - Vendredi L'EST9:00am – 7:00pm
Samedi L'EST.....9:00am – 5:00pm

HITACHI CANADA, LTD.
1-2495 Meadowpine Blvd.
Mississauga, Ontario L5N 6C3

Información de Servicio

Al llamar a la línea de HITACHI SERVICE HOTLINE le preguntarán cierta información relacionada con el MODELO del Televisor y el número de SERIE para poder darle el soporte adecuado. Esta información se localiza en la parte POSTERIOR y al lado DERECHO del Televisor. Favor de seguir los siguientes pasos para encontrar esta información y proveerla al departamento de Servicio.

- 1 Observar el lado derecho del Televisor.
- 2 Localizar la etiqueta donde se muestra la información relacionada con el MODELO y número de SERIE.
- 3 El departamento de Servicio Hitachi necesitará esta información para proporcionarle el soporte adecuado relacionado a sus preguntas.

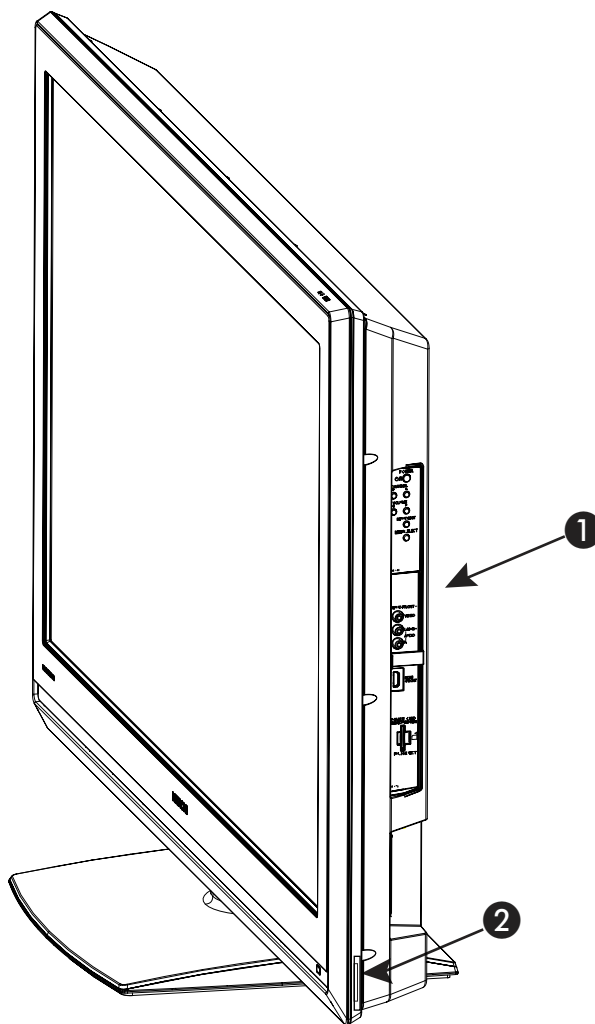

End User License Agreement for HITACHI DTV Software

END USER LICENSE AGREEMENT FOR HITACHI DTV SOFTWARE

IMPORTANT – READ CAREFULLY: This End User License Agreement for **HITACHI** DTV Software (this "Agreement") is a legal agreement between you ("you" or "your"), in your capacity as the owner of a **HITACHI** brand digital television (the "DTV"), and **HITACHI** America, Ltd., Home Electronics Division ("**HITACHI**"). By using the DTV or the digital television software installed on the DTV (the "DTV Software") or any Upgrade (as defined below, and together with the DTV Software, the "Software"), you agree to be bound by the terms and conditions of this Agreement. IF YOU DO NOT AGREE TO BE BOUND BY THIS LICENSE AGREEMENT, DO NOT USE THE DTV OR THE SOFTWARE.

1. **LICENSE GRANT.** **HITACHI** grants to you, for the life of the DTV, a non-exclusive, non-transferable, revocable license to install and use one copy of the Software on the DTV, subject to the following limitations and restrictions:
 - a. You may not share, duplicate, republish or redistribute the Software;
 - b. You may not resell, rent, lease, sublicense, gift, loan, assign or otherwise transfer the Software or any of your rights under this Agreement;
 - c. You may not modify, adapt, translate, reverse engineer, decompile, disassemble or make derivative works from the Software or use the Software in combination with any non-Hitachi software; and
 - d. You may not use the Software for any commercial purpose.
2. **VIOLATIONS; INDEMNITY.** You understand and agree that your use of the Software in any manner except as permitted under this Agreement could constitute a serious crime and could subject you to damages and an award to **HITACHI** of attorneys' fees in connection with your violation of this Agreement. You further understand that you may be held legally responsible for any copyright infringement or other violation of intellectual property rights caused or facilitated by your failure to abide by the terms of this Agreement. You agree to defend, indemnify and hold **HITACHI** and its parent and affiliate companies harmless from and against any and all liability resulting from any breach by you of this Agreement.
3. **INTELLECTUAL PROPERTY.** The Software is protected by federal copyright laws, international copyright treaties and other intellectual property laws and treaties. The Software is licensed, not sold, to you. All right, title and interest in and to the Software and any intellectual property associated therewith, including any accompanying printed materials, shall belong to **HITACHI** and its licensors and suppliers. Except as expressly provided herein, neither **HITACHI** nor any of its licensors or suppliers grants to you under this Agreement any express or implied right in or to any patents, copyrights, trademarks, trade secrets or other intellectual property. All right, title and interest in and to the intellectual property rights associated with any content that is accessible through use of the Software shall belong to the applicable content owners and may be protected by copyright or other intellectual property laws and treaties. This Agreement grants you no rights to use such content. Any rights of **HITACHI** not expressly granted to you hereunder are reserved expressly by Hitachi.
4. **SOFTWARE UPGRADES.** In the future, **HITACHI** may release or make available one or more upgrades to the DTV Software (each, an "Upgrade"). You understand and agree that if you decide to install or use any Upgrade, your installation and use of such Upgrade and/or any other software or intellectual property **HITACHI** may provide in connection therewith shall be governed by the terms and conditions of this Agreement, except to the extent that **HITACHI** provides different or supplementary license terms or conditions that accompany such Upgrade or other software or intellectual property. In the event **HITACHI** provides you with a "flash card" or other media to effect or facilitate an Upgrade, you understand and acknowledge that your failure to return such flash card or other media to **HITACHI** as **HITACHI** may require could result in **HITACHI** placing your name and your DTV's serial number on a "No Further Upgrades" list, which will prohibit you from receiving any subsequent Upgrades **HITACHI** may later release or make available. IF YOU DO NOT AGREE WITH ALL THE TERMS AND CONDITIONS OF THIS AGREEMENT OR ALL THE TERMS AND CONDITIONS OF ANY DIFFERENT OR SUPPLEMENTARY LICENSE THAT MAY ACCOMPANY SUCH UPGRADE, (A) DO NOT USE ANY HITACHI-PROVIDED FLASH CARD OR OTHER MEDIA, (B) DO NOT PERFORM INSTALL ANY HITACHI-PROVIDED UPGRADE SOFTWARE ON YOUR DTV, AND (C) PROMPTLY RETURN SUCH FLASH CARD OR OTHER MEDIA TO HITACHI.
5. **EXPORT RESTRICTIONS.** **HITACHI** is licensing the Software for use within North America only. You agree that you will not export or re-export the Software. You specifically agree not to export or re-export the Software: (i) to any country to which the U.S. has embargoed or restricted the export of goods or services, which currently include, but are not necessarily limited to Cuba, Iran, Libya, North Korea, Sudan and Syria, or to any national of any such country, wherever located, who intends to transmit or transport the Software back to such country; (ii) to any person or entity who you know or have reason to know will utilize the Software in the design, development, or production of nuclear, chemical, or biological weapons; or (iii) to any person or entity who has been prohibited from participating in U.S. export transactions by any federal agency of the U.S. government. You warrant and represent that neither the U.S. Bureau of Industry and Security nor any other U.S. federal Agency has suspended, revoked, or denied your export privileges.
6. **NOWARRANTIES.** The software is provided to you in "as is" condition and **HITACHI** makes no warranties of any kind whatsoever regarding the software and, to the maximum extent permitted by law, hereby expressly disclaims all warranties of any kind whatsoever, express or implied, with respect to the software. All implied warranties, including without limitation, the implied warranties of non-infringement, merchantability and fitness for a particular purpose are hereby expressly disclaimed by hitachi to the maximum extent permitted by law.
7. **LIMITATION OF LIABILITY.** To the maximum extent permitted by applicable law, **HITACHI**, its licensors, suppliers, parent companies, affiliates, subsidiaries, employees and agents shall not under any circumstances be liable to you or any third parties for any damages of any nature arising in any way from this agreement, your use of the software or otherwise, whether indirect, special, incidental, consequential or otherwise, including, without limitation, any claims for lost profits, lost good will, lost data, business interruption, procurement of substitute goods or services, or expenditures made or committed for in reliance on the continuation of this agreement, even if advised in advance of the possibility of such damages.
8. **NO FAILURE OF ESSENTIAL PURPOSE.** You agree that neither **HITACHI'S** breach of this agreement nor its failure to repair a defect, error or bug in the software shall constitute a failure of the essential purpose of this agreement.
9. **CRYPTOGRAPHIC SOFTWARE.** The software contains software developed by the OpenSSL Project, including cryptographic software written by eric young (the "cryptographic software"). The cryptographic software is provided by the OpenSSL Project in "as is" condition and any express or implied warranties, including but not limited to, the implied warranties of merchantability and fitness for a particular purpose are hereby expressly disclaimed to the maximum extent permitted by law. In no event shall the OpenSSL Project, its contributors, **HITACHI** or any of its parent or affiliate companies be liable for any direct, indirect, incidental, special, exemplary, or consequential damages (including, but not limited to, procurement of substitute goods or services; loss of use, data, or profits; or business interruption) however caused and on any theory of liability, whether in contract, strict liability, or tort (including negligence or otherwise) arising in any way out of the use of the software or the cryptographic software, even if advised in advance of the possibility of such damages.
10. **TERMINATION.** **HITACHI** may terminate this Agreement immediately at any time by providing notice to you.
11. **GOVERNING LAW; SEVERABILITY.** This Agreement will be governed by the laws of the State of New York, and you consent to the exclusive jurisdiction and venue in the federal courts sitting in the Southern District of New York, unless no federal subject matter jurisdiction exists, in which case you consent to the exclusive jurisdiction and venue in the Borough of Manhattan, New York, USA.

End User License Agreements for Operating System Software

OPERATING SYSTEM LICENSE INFORMATION

This HITACHI TV incorporates certain open source operating system software distributed under the GNU GENERAL PUBLIC LICENSE Version 2 and GNU LESSER GENERAL PUBLIC LICENSE Version 2.1 as defined by the Free Software Foundation, Inc.

The operating system software incorporated in this Hitachi TV is shown in the table below and the applicable license(s) are detailed on the following pages of this Owner's Guide.

Software Module	Applicable Software License
Linux Kernel busybox dhcpcd ifupdown net-tool iptables libstdc++5	GNU GENERAL PUBLIC LICENSE Version 2
glibc libposixtime	GNU LESSER GENERAL PUBLIC LICENSE Version 2.1

If you want to know more about the Software Module,
please E-mail us at : tvsoftwaresupport@hea.hitachi.com

End User License Agreement for Operating System Software

GNU GENERAL PUBLIC LICENSE Version 2, June 1991

Copyright © 1989, 1991 Free Software Foundation, Inc.

51 Franklin St, Fifth Floor, Boston, MA 02110-1301 USA

Everyone is permitted to copy and distribute verbatim copies of this license document, but changing is not allowed.

Preamble

The licenses for most software are designed to take away your freedom to share and change it. By contrast, the GNU General Public License is intended to guarantee your freedom to share and change free software—to make sure the software is free for all its users. This General Public License applies to most of the Free Software Foundation's software and to any other program whose authors commit to using it. (Some other Free Software Foundation software is covered by the GNU Library General Public License instead.) You can apply it to your programs, too.

When we speak of free software, we are referring to freedom, not price. Our General Public Licenses are designed to make sure that you have the freedom to distribute copies of free software (and charge for this service if you wish), that you receive source code or can get it if you want it, that you can change the software or use pieces of it in new free programs; and that you know you can do these things.

To protect your rights, we need to make restrictions that forbid anyone to deny you these rights or to ask you to surrender the rights. These restrictions translate to certain responsibilities for you if you distribute copies of the software, or if you modify it.

For example, if you distribute copies of such a program, whether free or for a fee, you must give the recipients all the rights that you have. You must make sure that they, too, receive or can get the source code. And you must show them these terms so they know their rights.

We protect your rights with two steps: (1) copyright the software, and (2) offer you this license which gives you legal permission to copy, distribute and/or modify the software.

Also, for each author's protection and ours, we want to make certain that everyone understands that there is no warranty for this free software. If the software is modified by someone else and passed on, we want its recipients to know that what they have is not the original, so that any problems introduced by others will not reflect on the original authors' reputations.

Finally, any free program is threatened constantly by software patents. We wish to avoid the danger that redistributors of a free program will individually obtain patent licenses, in effect making the program proprietary. To prevent this, we have made it clear that any patent must be licensed for everyone's free use or not licensed at all.

The precise terms and conditions for copying, distribution and modification follow.

GNU GENERAL PUBLIC LICENSE TERMS AND CONDITIONS FOR COPYING, DISTRIBUTION AND MODIFICATION

0. This License applies to any program or other work which contains a notice placed by the copyright holder saying it may be distributed under the terms of this General Public License. The "Program", below, refers to any such program or work, and a "work based on the Program" means either the Program or any derivative work under copyright law: that is to say, a work containing the Program or a portion of it, either verbatim or with modifications and/or translated into another language.

(Hereinafter, translation is included without limitation in the term "modification".) Each licensee is addressed as "you".

Activities other than copying, distribution and modification are not covered by this License; they are outside its scope. The act of running the Program is not restricted, and the output from the Program is covered only if its contents constitute a work based on the Program (independent of having been made by running the Program). Whether that is true depends on what the Program does.

1. You may copy and distribute verbatim copies of the Program's source code as you receive it, in any medium, provided that you conspicuously and appropriately publish on each copy an appropriate copyright notice and disclaimer of warranty; keep intact all the notices that refer to this License and to the absence of any warranty; and give any other recipients of the Program a copy of this License along with the Program.

You may charge a fee for the physical act of transferring a copy, and you may at your option offer warranty protection in exchange for a fee.

2. You may modify your copy or copies of the Program or any portion of it, thus forming a work based on the Program, and copy and distribute such modifications or work under the terms of Section 1 above, provided that you also meet all of these conditions:

- a) You must cause the modified files to carry prominent notices stating that you changed the files and the date of any change.
- b) You must cause any work that you distribute or publish, that in whole or in part contains or is derived from the Program or any part thereof, to be licensed as a whole at no charge to all third parties under the terms of this License.
- c) If the modified program normally reads commands interactively when run, you must cause it, when started running for such interactive use in the most ordinary way, to print or display an announcement including an appropriate copyright notice and a notice that there is no warranty (or else, saying that you provide a warranty) and that users may redistribute the program under these conditions, and telling the user how to view a copy of this License. (Exception: if the Program itself is interactive but does not normally print such an announcement, your work based on the Program is not required to print an announcement.)

These requirements apply to the modified work as a whole. If identifiable sections of that work are not derived from the Program, and can be reasonably considered independent and separate works in themselves, then this License, and its terms, do not apply to those sections when you distribute them as separate works. But when you distribute the same sections as part of a whole which is a work based on the Program, the distribution of the whole must be on the terms of this License, whose permissions for other licenses extend to the entire whole, and thus to each and every part regardless of who wrote it.

Thus, it is not the intent of this section to claim rights or contest your rights to work written entirely by you; rather, the intent is to exercise the right to control the distribution of derivative or collective works based on the Program.

End User License Agreement for Operating System Software

In addition, mere aggregation of another work not based on the Program with the Program (or with a work based on the Program) on a volume of a storage or distribution medium does not bring the other work under the scope of this License.

3. You may copy and distribute the Program (or a work based on it, under Section 2) in object code or executable form under the terms of Sections 1 and 2 above provided that you also do one of the following:

- a) Accompany it with the complete corresponding machine-readable source code, which must be distributed under the terms of Sections 1 and 2 above on a medium customarily used for software interchange; or,
- b) Accompany it with a written offer, valid for at least three years, to give any third party, for a charge no more than your cost of physically performing source distribution, a complete machine-readable copy of the corresponding source code, to be distributed under the terms of Sections 1 and 2 above on a medium customarily used for software interchange; or,
- c) Accompany it with the information you received as to the offer to distribute corresponding source code. (This alternative is allowed only for noncommercial distribution and only if you received the program in object code or executable form with such an offer, in accord with Subsection b above.)

The source code for a work means the preferred form of the work for making modifications to it. For an executable work, complete source code means all the source code for all modules it contains, plus any associated interface definition files, plus the scripts used to control compilation and installation of the executable. However, as a special exception, the source code distributed need not include anything that is normally distributed (in either source or binary form) with the major components (compiler, kernel, and so on) of the operating system on which the executable runs, unless that component itself accompanies the executable.

If distribution of executable or object code is made by offering access to copy from a designated place, then offering equivalent access to copy the source code from the same place counts as distribution of the source code, even though third parties are not compelled to copy the source along with the object code.

4. You may not copy, modify, sublicense, or distribute the Program except as expressly provided under this License. Any attempt otherwise to copy, modify, sublicense or distribute the Program is void, and will automatically terminate your rights under this License. However, parties who have received copies, or rights, from you under this License will not have their licenses terminated so long as such parties remain in full compliance.

5. You are not required to accept this License, since you have not signed it. However, nothing else grants you permission to modify or distribute the Program or its derivative works. These actions are prohibited by law if you do not accept this License. Therefore, by modifying or distributing the Program (or any work based on the Program), you indicate your acceptance of this License to do so, and all its terms and conditions for copying, distributing or modifying the Program or works based on it.

6. Each time you redistribute the Program (or any work based on the Program), the recipient automatically receives a license from the original licensor to copy, distribute or modify the Program subject to these terms and conditions. You may not impose any further restrictions on the recipients' exercise of the rights granted herein. You are not responsible for enforcing compliance by third parties to this License.

7. If, as a consequence of a court judgment or allegation of patent infringement or for any other reason (not limited to patent issues), conditions are imposed on you (whether by court order, agreement or otherwise) that contradict the conditions of this License, they do not excuse you from the conditions of this License. If you cannot distribute so as to satisfy simultaneously your obligations under this License and any other pertinent obligations, then as a consequence you may not distribute the Program at all.

For example, if a patent license would not permit royalty-free redistribution of the Program by all those who receive copies directly or indirectly through you, then the only way you could satisfy both it and this License would be to refrain entirely from distribution of the Program. If any portion of this section is held invalid or unenforceable under any particular circumstance, the balance of the section is intended to apply and the section as a whole is intended to apply in other circumstances.

It is not the purpose of this section to induce you to infringe any patents or other property right claims or to contest validity of any such claims; this section has the sole purpose of protecting the integrity of the free software distribution system, which is implemented by public license practices. Many people have made generous contributions to the wide range of software distributed through that system in reliance on consistent application of that system; it is up to the author/donor to decide if he or she is willing to distribute software through any other system and a license cannot impose that choice.

This section is intended to make thoroughly clear what is believed to be a consequence of the rest of this License.

8. If the distribution and/or use of the Program is restricted in certain countries either by patents or by copyrighted interfaces, the original copyright holder who places the Program under this License may add an explicit geographical distribution limitation excluding those countries, so that distribution is permitted only in or among countries not thus excluded. In such case, this License incorporates the limitation as if written in the body of this License.

9. The Free Software Foundation may publish revised and/or new versions of the General Public License from time to time. Such new versions will be similar in spirit to the present version, but may differ in detail to address new problems or concerns.

Each version is given a distinguishing version number. If the Program specifies a version number of this License which applies to it and "any later version", you have the option of following the terms and conditions either of that version or of any later version published by the Free Software Foundation. If the Program does not specify a version number of this License, you may choose any version ever published by the Free Software Foundation.

10. If you wish to incorporate parts of the Program into other free programs whose distribution conditions are different, write to the author to ask for permission. For software which is copyrighted by the Free Software Foundation, write to the Free Software Foundation; we sometimes make exceptions for this. Our decision will be guided by the two goals of preserving the free status of all derivatives of our free software and of promoting the sharing and reuse of software generally.

NO WARRANTY

11. BECAUSE THE PROGRAM IS LICENSED FREE OF CHARGE, THERE IS NO WARRANTY FOR THE PROGRAM, TO THE EXTENT PERMITTED BY APPLICABLE LAW. EXCEPT WHEN OTHERWISE STATED IN WRITING THE COPYRIGHT HOLDERS AND/OR OTHER PARTIES PROVIDE THE PROGRAM "AS IS" WITHOUT WARRANTY OF ANY KIND, EITHER EXPRESSED OR IMPLIED, INCLUDING, BUT NOT LIMITED

End User License Agreement for Operating System Software

TO, THE IMPLIED WARRANTIES OF MERCHANTABILITY AND FITNESS FOR A PARTICULAR PURPOSE. THE ENTIRE RISK AS TO THE QUALITY AND PERFORMANCE OF THE PROGRAM IS WITH YOU. SHOULD THE PROGRAM PROVE DEFECTIVE, YOU ASSUME THE COST OF ALL NECESSARY SERVICING, REPAIR OR CORRECTION.

12. IN NO EVENT UNLESS REQUIRED BY APPLICABLE LAW OR AGREED TO IN WRITING WILL ANY COPYRIGHT HOLDER, OR ANY OTHER PARTY WHO MAY MODIFY AND/OR REDISTRIBUTE THE PROGRAM AS PERMITTED ABOVE, BE LIABLE TO YOU FOR DAMAGES, INCLUDING ANY GENERAL, SPECIAL, INCIDENTAL OR CONSEQUENTIAL DAMAGES ARISING OUT OF THE USE OR INABILITY TO USE THE PROGRAM (INCLUDING BUT NOT LIMITED TO LOSS OF DATA OR DATA BEING RENDERED INACCURATE OR LOSSES SUSTAINED BY YOU OR THIRD PARTIES OR A FAILURE OF THE PROGRAM TO OPERATE WITH ANY OTHER PROGRAMS), EVEN IF SUCH HOLDER OR OTHER PARTY HAS BEEN ADVISED OF THE POSSIBILITY OF SUCH DAMAGES.

END OF TERMS AND CONDITIONS

How to Apply These Terms to Your New Programs

If you develop a new program, and you want it to be of the greatest possible use to the public, the best way to achieve this is to make it free software which everyone can redistribute and change under these terms.

To do so, attach the following notices to the program. It is safest to attach them to the start of each source file to most effectively convey the exclusion of warranty; and each file should have at least the "copyright" line and a pointer to where the full notice is found.

<one line to give the program's name and a brief idea of what it does.>

Copyright © <year> <name of author>

This program is free software; you can redistribute it and/or modify it under the terms of the GNU General Public License as published by the Free Software Foundation; either version 2 of the License, or (at your option) any later version.

This program is distributed in the hope that it will be useful, but WITHOUT ANY WARRANTY; without even the implied warranty of MERCHANTABILITY or FITNESS FOR A PARTICULAR PURPOSE. See the GNU General Public License for more details.

You should have received a copy of the GNU General Public License along with this program; if not, write to the Free Software Foundation, Inc., 51 Franklin St, Fifth Floor, Boston, MA 02110-1301 USA

Also add information on how to contact you by electronic and paper mail.

If the program is interactive, make it output a short notice like this when it starts in an interactive mode:

Gnomovision version 69, Copyright © year name of author
Gnomovision comes with ABSOLUTELY NO WARRANTY;
for details type `show w'. This is free software, and you are
welcome to redistribute it under certain conditions; type `show
c' for details.

The hypothetical commands `show w' and `show c' should show the appropriate parts of the General Public License. Of course, the commands you use may be called something other than `show w' and `show c'; they could even be mouse-clicks or menu items--whatever suits your program.

You should also get your employer (if you work as a programmer) or your school, if any, to sign a "copyright disclaimer" for the program, if necessary. Here is a sample; alter the names:

Yoyodyne, Inc., hereby disclaims all copyright interest in the program `Gnomovision' (which makes passes at compilers) written by James Hacker.

<signature of Ty Coon>, 1 April 1989
Ty Coon, President of Vice

This General Public License does not permit incorporating your program into proprietary programs. If your program is a subroutine library, you may consider it more useful to permit linking proprietary applications with the library. If this is what you want to do, use the GNU Library General Public License instead of this License.

End User License Agreement for Operating System Software

GNU LESSER GENERAL PUBLIC LICENSE Version 2.1, February 1999

Copyright © 1991, 1999 Free Software Foundation, Inc. 51 Franklin St, Fifth Floor, Boston, MA 02110-1301 USA
Everyone is permitted to copy and distribute verbatim copies of this license document, but changing it is not allowed.

[This is the first released version of the Lesser GPL. It also counts as the successor of the GNU Library Public License, version 2, hence the version number 2.1.]

Preamble

The licenses for most software are designed to take away your freedom to share and change it. By contrast, the GNU General Public Licenses are intended to guarantee your freedom to share and change free software--to make sure the software is free for all its users.

This license, the Lesser General Public License, applies to some specially designated software packages--typically libraries--of the Free Software Foundation and other authors who decide to use it. You can use it too, but we suggest you first think carefully about whether this license or the ordinary General Public License is the better strategy to use in any particular case, based on the explanations below.

When we speak of free software, we are referring to freedom of use, not price. Our General Public Licenses are designed to make sure that you have the freedom to distribute copies of free software (and charge for this service if you wish); that you receive source code or can get it if you want it; that you can change the software and use pieces of it in new free programs; and that you are informed that you can do these things.

To protect your rights, we need to make restrictions that forbid distributors to deny you these rights or to ask you to surrender these rights. These restrictions translate to certain responsibilities for you if you distribute copies of the library or if you modify it.

For example, if you distribute copies of the library, whether gratis or for a fee, you must give the recipients all the rights that we gave you. You must make sure that they, too, receive or can get the source code. If you link other code with the library, you must provide complete object files to the recipients, so that they can relink them with the library after making changes to the library and recompiling it. And you must show them these terms so they know their rights.

We protect your rights with a two-step method: (1) we copyright the library, and (2) we offer you this license, which gives you legal permission to copy, distribute and/or modify the library.

To protect each distributor, we want to make it very clear that there is no warranty for the free library. Also, if the library is modified by someone else and passed on, the recipients should know that what they have is not the original version, so that the original author's reputation will not be affected by problems that might be introduced by others.

Finally, software patents pose a constant threat to the existence of any free program. We wish to make sure that a company cannot effectively restrict the users of a free program by obtaining a restrictive license from a patent holder. Therefore, we insist that any patent license obtained for a version of the library must be consistent with the full freedom of use specified in this license.

Most GNU software, including some libraries, is covered by the ordinary GNU General Public License. This license, the GNU Lesser General Public License, applies to certain designated libraries, and is quite different from the ordinary General Public License. We use this license for certain libraries in order to permit linking those libraries into non-free programs.

When a program is linked with a library, whether statically or using a shared library, the combination of the two is legally speaking a combined work, a derivative of the original library. The ordinary General Public License therefore permits such linking only if the entire combination fits its criteria of freedom. The Lesser General Public License permits more lax criteria for linking other code with the library.

We call this license the "Lesser" General Public License because it does Less to protect the user's freedom than the ordinary General Public License. It also provides other free software developers Less of an advantage over competing non-free programs. These disadvantages are the reason we use the ordinary General Public License for many libraries. However, the Lesser license provides advantages in certain special circumstances.

For example, on rare occasions, there may be a special need to encourage the widest possible use of a certain library, so that it becomes a de-facto standard. To achieve this, non-free programs must be allowed to use the library. A more frequent case is that a free library does the same job as widely used non-free libraries. In this case, there is little to gain by limiting the free library to free software only, so we use the Lesser General Public License.

In other cases, permission to use a particular library in non-free programs enables a greater number of people to use a large body of free software. For example, permission to use the GNU C Library in non-free programs enables many more people to use the whole GNU operating system, as well as its variant, the GNU/Linux operating system.

Although the Lesser General Public License is Less protective of the users' freedom, it does ensure that the user of a program that is linked with the Library has the freedom and the wherewithal to run that program using a modified version of the Library.

The precise terms and conditions for copying, distribution and modification follow. Pay close attention to the difference between a "work based on the library" and a "work that uses the library". The former contains code derived from the library, whereas the latter must be combined with the library in order to run.

GNU LESSER GENERAL PUBLIC LICENSE TERMS AND CONDITIONS FOR COPYING, DISTRIBUTION AND MODIFICATION

0. This License Agreement applies to any software library or other program which contains a notice placed by the copyright holder or other authorized party saying it may be distributed under the terms of this Lesser General Public License (also called "this License"). Each licensee is addressed as "you".

A "library" means a collection of software functions and/or data prepared so as to be conveniently linked with application programs (which use some of those functions and data) to form executables.

The "Library", below, refers to any such software library or work which has been distributed under these terms. A "work based on the Library" means either the Library or any derivative work under copyright law: that is to say, a work containing the Library or a portion of it, either verbatim or with modifications and/or translated

End User License Agreement for Operating System Software

straightforwardly into another language. (Hereinafter, translation included without limitation in the term "modification".)

"Source code" for a work means the preferred form of the work for making modification to it. For a library, complete source code means all the source code for all modules it contains, plus any associated interface definition files, plus the scripts used to control compilation and installation of the library.

Activities other than copying, distribution and modification are not covered by this License; they are outside its scope. The act of running a program using the Library is not restricted, and output from such a program is covered only if its contents constitute a work based on the Library (independent of the use of the Library in a tool for writing it). Whether that is true depends on what the Library does and what the program that uses the Library does.

1. You may copy and distribute verbatim copies of the Library's complete source code as you receive it, in any medium, provided that you conspicuously and appropriately publish on each copy an appropriate copyright notice and disclaimer of warranty; keep intact all the notices that refer to this License and to the absence of any warranty; and distribute a copy of this License along with the Library.

You may charge a fee for the physical act of transferring a copy, and you may at your option offer warranty protection in exchange for a fee.

2. You may modify your copy or copies of the Library or any portion of it, thus forming a work based on the Library, and copy and distribute such modifications or work under the terms of Section 1 above, provided that you also meet all of these conditions:

- a) The modified work must itself be a software library
- b) You must cause the files modified to carry prominent notices stating that you changed the files and the date of any change.
- c) You must cause the whole of the work to be licensed at no charge to all third parties under the terms of this License.
- d) If a facility in the modified Library refers to a function or a table of data to be supplied by an application program that uses the facility, other than as an argument passed when the facility is invoked, then you must make a good faith effort to ensure that, in the event an application does not supply such function or table, the facility still operates, and performs whatever part of its purpose remains meaningful. (For example, a function in a library to compute square roots has a purpose that is entirely well-defined independent of the application. Therefore, Subsection 2d requires that any application-supplied function or table used by this function must be optional: if the application does not supply it, the square root function must still compute squares roots.)

These requirements apply to the modified work as a whole. If identifiable sections of that work are not derived from the Library, and can be reasonably considered independent and separate works in themselves, then this License, and its terms, do not apply to those sections when you distribute them as separate works. But when you distribute the same sections as part of a whole which is a work based on the Library, the distribution of the whole must be on the terms of this License, whose permissions for other licenses extend to the entire whole, and thus to each and every part regardless of who wrote it.

Thus, it is not the intent of this section to claim rights or contest your rights to work written entirely by you; rather, the intent is

to exercise the right to control the distribution of derivative or collective works based on the Library.

In addition, mere aggregation of another work not based on the Library with the Library (or with a work based on the Library) on a volume of a storage or distribution medium does not bring the other work under the scope of this License.

3. You may opt to apply the terms of the ordinary GNU General Public License instead of this License to a given copy of the Library. To do this, you must alter all the notices that refer to this License, so that they refer to the ordinary GNU General Public License, version 2, instead of to this License. (If a newer version than version 2 of the ordinary GNU General Public License has appeared, then you can specify that version instead if you wish.) Do not make any other change in these notices.

Once this change is made in a given copy, it is irreversible for that copy, so the ordinary GNU General Public License applies to all subsequent copies and derivative works made from that copy.

This option is useful when you wish to copy part of the code of the Library into a program that is not a library.

4. You may copy and distribute the Library (or a portion or derivative of it, under Section 2) in object code or executable form under the terms of Sections 1 and 2 above provided that you accompany it with the complete corresponding machine-readable source code, which must be distributed under the terms of Sections 1 and 2 above on a medium customarily used for software interchange.

If distribution of object code is made by offering access to copy from a designated place, then offering equivalent access to copy the source code from the same place satisfies the requirement to distribute the source code, even though third parties are not compelled to copy the source along with the object code.

5. A program that contains no derivative of any portion of the Library, but is designed to work with the Library by being compiled or linked with it, is called a "work that uses the Library". Such a work, in isolation, is not a derivative work of the Library, and therefore falls outside the scope of this License.

However, linking a "work that uses the Library" with the Library creates an executable that is a derivative of the Library (because it contains portions of the Library), rather than a "work that uses the library". The executable is therefore covered by this License. Section 6 states terms for distribution of such executables.

When a "work that uses the Library" uses material from a header file that is part of the Library, the object code for the work may be a derivative work of the Library even though the source code is not. Whether this is true is especially significant if the work can be linked without the Library, or if the work is itself a library. The threshold for this to be true is not precisely defined by law.

If such an object file uses only numerical parameters, data structure layouts and accessors, and small macros and small inline functions (ten lines or less in length then the use of the object file is unrestricted, regardless of whether it is legally a derivative work. (Executables containing this object code plus portions of the Library will still fall under Section 6.)

Otherwise, if the work is a derivative of the Library, you may distribute the object code for the work under the terms of Section 6. Any executables containing that work also fall under Section 6, whether or not they are linked directly with the Library itself.

6. As an exception to the Sections above, you may also combine or link a "work that uses the Library" with the Library to produce

End User License Agreement for Operating System Software

a work containing portions of the Library, and distribute that work under terms of your choice, provided that the terms permit modification of the work for the customer's own use and reverse engineering for debugging such modifications.

You must give prominent notice with each copy of the work that the Library is used in it and that the Library and its use are covered by this License. You must supply a copy of this License. If the work during execution displays copyright notices, you must include the copyright notice for the Library among them, as well as a reference directing the user to the copy of this License. Also, you must do one of these things:

- a) Accompany the work with the complete corresponding machine-readable source code for the Library including whatever changes were used in the work (which must be distributed under Sections 1 and 2 above); and, if the work is an executable linked with the Library, with the complete machine-readable "work that uses the Library", as object code and/or source code, so that the user can modify the Library and then relink to produce a modified executable containing the modified Library. (It is understood that the user who changes the contents of definitions files in the Library will not necessarily be able to recompile the application to use the modified definitions.)
- b) Use a suitable shared library mechanism for linking with the Library. A suitable mechanism is one that (1) uses at run time a copy of the library already present on the user's computer system, rather than copying library functions into the executable, and (2) will operate properly with a modification version of the library, if the user installs one, as long as the modified version is interface-compatible with the version that the work was made with.
- c) Accompany the work with a written offer, valid for at least three years, to give the same user the materials specified in Subsection 6a, above, for a charge no more than the cost of performing this distribution.
- d) If distribution of the work is made by offering access to copy from a designated place, offer equivalent access to copy the above specified materials from the same place.
- e) Verify that the user has already received a copy of these materials or that you have already sent this user a copy.

For an executable, the required form of the "work that uses the Library" must include any data and utility programs needed for reproducing the executable from it. However, as a special exception, the materials to be distributed need not include anything that is normally distributed (in either source or binary form) with the major components (compiler, kernel, and so on) of the operating system on which the executable runs, unless that component itself accompanies the executable.

It may happen that this requirement contradicts the license restrictions of other proprietary libraries that do not normally accompany the operating system. Such a contradiction means you cannot use both them and the Library together in an executable that you distribute.

7. You may place library facilities that are a work based on the Library side-by-side in a single library together with other library facilities not covered by this License, and distribute such a combined library, provided that the separate distribution of the work based on the Library and of the other library facilities is otherwise permitted, and provided that you do these two things:

- a) Accompany the combined library with a copy of the same work based on the Library, uncombined with any other library facilities. This must be distributed under the terms of

the Sections above.

- b) Give prominent notice with the combined library of the fact that part of it is a work based on the Library, and explaining where to find the accompanying uncombined form of the same work.

8. You may not copy, modify, sublicense, link with, or distribute the Library except as expressly provided under this License. Any attempt otherwise to copy, modify, sublicense, link with, or distribute the Library is void, and will automatically terminate your rights under this License. However, parties who have received copies, or rights, from you under this License will not have their licenses terminated so long as such parties remain in full compliance.

9. You are not required to accept this License, since you have not signed it. However, nothing else grants you permission to modify or distribute the Library or its derivative works. These actions are prohibited by law if you do not accept this License. Therefore, by modifying or distributing the Library (or any work based on the Library), you indicate your acceptance of this License to do so, and all its terms and conditions for copying, distributing or modifying the Library or works based on it.

10. Each time you redistribute the Library (or any work based on the Library), the recipient automatically receives a license from the original licensor to copy, distribute, link with or modify the Library subject to these terms and conditions. You may not impose any further restrictions on the recipients' exercise of the rights granted herei. You are not responsible for enforcing compliance by third parties with this License

11. If, as a consequence of a court judgment or allegation of patent infringement or for any other reason (not limited to patent issues), conditions are imposed on you (whether by court order, agreement or otherwise) that contradict the conditions of this License, they do not excuse you from the conditions of this License. If you cannot distribute so as to satisfy simultaneously your obligations under this License and any other pertinent obligations, then as a consequence you may not distribute the Library at all. For example, if a patent license would not permit royalty-free redistribution of the Library by all those who receive copies directly or indirectly through you, then the only way you could satisfy both it and this License would be to refrain entirely from distribution of the Library.

If any portion of this section is held invalid or unenforceable under any particular circumstance, the balance of the section is intended to apply, and the section as a whole is intended to apply in other circumstances.

It is not the purpose of this section to induce you to infringe any patents or other property right claims or to contest validity of any such claims; this section has the sole purpose of protecting the integrity of the free software distribution system which is implemented by public license practices. Many people have made generous contributions to the wide range of software distributed through that system in reliance on consistent application of that system; it is up to the author/donor to decide if he or she is willing to distribute software through any other system and a license cannot impose that choice.

This section is intended to make thoroughly clear what is believed to be a consequence of the rest of this License.

12. If the distribution and/or use of the Library is restricted in certain countries either by patents or by copyrighted interfaces, the original copyright holder who places the Library under this License may add an explicit geographical distribution limitation excluding those countries, so that distribution is permitted only in

End User License Agreement for Operating System Software

or among countries not thus excluded. In such case, this License incorporates the limitation as if written in the body of this License.

13. The Free Software Foundation may publish revised and/or new versions of the Lesser General Public License from time to time. Such new versions will be similar in spirit to the present version, but may differ in detail to address new problems or concerns. Each version is given a distinguishing version number. If the Library specifies a version number of this License which applies to it and "any later version", you have the option of following the terms and conditions either of that version or of any later version published by the Free Software Foundation. If the Library does not specify a license version number, you may choose any version ever published by the Free Software Foundation.

14. If you wish to incorporate parts of the Library into other free programs whose distribution conditions are incompatible with these, write to the author to ask for permission. For software which is copyrighted by the Free Software Foundation, write to the Free Software Foundation; we sometimes make exceptions for this. Our decision will be guided by the two goals of preserving the free status of all derivatives of our free software and of promoting the sharing and reuse of software generally.

NO WARRANTY

15. BECAUSE THE LIBRARY IS LICENSED FREE OF CHARGE, THERE IS NO WARRANTY FOR THE LIBRARY, TO THE EXTENT PERMITTED BY APPLICABLE LAW. EXCEPT WHEN OTHERWISE STATED IN WRITING THE COPYRIGHT HOLDERS AND/OR OTHER PARTIES PROVIDE THE LIBRARY "AS IS" WITHOUT WARRANTY OF ANY KIND, EITHER EXPRESSED OR IMPLIED, INCLUDING, BUT NOT LIMITED TO, THE IMPLIED WARRANTIES OF MERCHANTABILITY AND FITNESS FOR A PARTICULAR PURPOSE. THE ENTIRE RISK AS TO THE QUALITY AND PERFORMANCE OF THE LIBRARY IS WITH YOU. SHOULD THE LIBRARY PROVE DEFECTIVE, YOU ASSUME THE COST OF ALL NECESSARY SERVICING, REPAIR OR CORRECTION.

16. IN NO EVENT UNLESS REQUIRED BY APPLICABLE LAW OR AGREED TO IN WRITING WILL ANY COPYRIGHT HOLDER, OR ANY OTHER PARTY WHO MAY MODIFY AND/OR REDISTRIBUTE THE LIBRARY AS PERMITTED ABOVE, BE LIABLE TO YOU FOR DAMAGES, INCLUDING ANY GENERAL, SPECIAL, INCIDENTAL OR CONSEQUENTIAL DAMAGES ARISING OUT OF THE USE OR INABILITY TO USE THE LIBRARY (INCLUDING BUT NOT LIMITED TO LOSS OF DATA OR DATA BEING RENDERED INACCURATE OR LOSSES SUSTAINED BY YOU OR THIRD PARTIES OR A FAILURE OF THE LIBRARY TO OPERATE WITH ANY OTHER SOFTWARE), EVEN IF SUCH HOLDER OR OTHER PARTY HAS BEEN ADVISED OF THE POSSIBILITY OF SUCH DAMAGES.

END OF TERMS AND CONDITIONS

How to Apply These Terms to Your New Libraries

If you develop a new library, and you want it to be of the greatest possible use to the public, we recommend making it free software that everyone can redistribute and change. You can do so by permitting redistribution under these terms (or, alternatively, under the terms of the ordinary General Public License).

To apply these terms, attach the following notices to the library. It is safest to attach them to the start of each source file to most effectively convey the exclusion of warranty; and each file should have at least the "copyright" line and a pointer to where the full notice is found.

<one line to give the library's name and a brief idea of what it does.>

Copyright © <year> <name of author>

This library is free software; you can redistribute it and/or modify it under the terms of the GNU Lesser General Public License as published by the Free Software Foundation; either version 2.1 of the License, or (at your option) any later version.

This library is distributed in the hope that it will be useful, but WITHOUT ANY WARRANTY; without even the implied warranty of MERCHANTABILITY or FITNESS FOR A PARTICULAR PURPOSE. See the GNU Lesser General Public License for more details.

You should have received a copy of the GNU Lesser General Public License along with this library; if not, write to the Free Software Foundation, Inc., 51 Franklin St, Fifth Floor, Boston, MA 02110-1301 USA

Also add information on how to contact you by electronic and paper mail.

You should also get your employer (if you work as a programmer) or your school, if any, to sign a "copyright disclaimer" for the library, if necessary. Here is a sample; alter the names: Yoyodyne, Inc., hereby disclaims all copyright interest in the library 'Frob' (a library for tweaking knobs) written by James Random Hacker.

<signature of Ty Coon>, 1 April 1990
Ty Coon, President of Vice

That's all there is to it!

Appendixes

Appendix A:

Picture Format for Each Input Source

Aspect Specifications

Yes : Selectable - : Un-selectable

Input Signal			Auto Aspect	Aspect Video ID	Aspect							
					16:9 Standard 1	16:9 Standard 2	16:9 Zoom	4:3 Standard	4:3 Expanded	4:3 Zoom 1	4:3 Zoom 2	
ANT Analog	Video	NTSC	-	4x3	Yes	-	Yes	Yes	Yes	Yes	Yes	
ANT Digital	YCbCr	480p	-	16x9	Yes	-	Yes	-	Yes	-	-	
		480i	-	4x3	-	-	-	Yes	Yes	Yes	Yes	
Input 1	Video S-Video	NTSC	Auto ON	16x9	Yes	Yes	Yes	-	Yes	-	-	
				Letter	-	-	-	Yes	Yes	Yes Initial	Yes	
				4x3	-	-	-	Yes	Yes Initial	Yes	Yes	
				No ID	Yes	-	Yes	Yes	Yes	Yes	Yes	
				Auto OFF	-	Yes	-	Yes	Yes	Yes	Yes	
Input 2	YPbPr	1080i/720p	-	16x9	Yes	Yes	Yes	-	Yes	-	-	
			Auto ON	480p	Yes Initial	-	Yes	-	-	-	-	
				480i	Letter	-	-	-	Yes	Yes	Yes Initial	Yes
				4x3	-	-	-	Yes	Yes Initial	Yes	Yes	
				No ID	Yes	-	Yes	Yes	Yes	Yes	Yes	
	Auto OFF	-	-	-	-	-	-	-				
	Video	NTSC	Auto ON	16x9	Yes Initial	-	Yes	-	-	-	-	
				Letter	-	-	-	Yes	Yes	Yes Initial	Yes	
				4x3	-	-	-	Yes	Yes Initial	Yes	Yes	
				No ID	Yes	-	Yes	Yes	Yes	Yes	Yes	
Auto OFF				-	Yes	-	Yes	Yes	Yes	Yes		
Input 3	YPbPr	1080i/720p	-	16x9	Yes	Yes	Yes	-	Yes	-	-	
			Auto ON	480p	Yes Initial	-	Yes	-	-	-	-	
				480i	Letter	-	-	-	Yes	Yes	Yes Initial	Yes
				4x3	-	-	-	Yes	Yes Initial	Yes	Yes	
				No ID	Yes	-	Yes	Yes	Yes	Yes	Yes	
	Auto OFF	-	-	-	-	-	-	-				
	Video	NTSC	Auto ON	16x9	Yes Initial	-	Yes	-	-	-	-	
				Letter	-	-	-	Yes	Yes	Yes Initial	Yes	
				4x3	-	-	-	Yes	Yes Initial	Yes	Yes	
				No ID	Yes	-	Yes	Yes	Yes	Yes	Yes	
Auto OFF				-	-	-	-	-	-	-		
Input Front	Video	NTSC	Auto ON	16x9	Yes Initial	-	Yes	-	-	-	-	
				Letter	-	-	-	Yes	Yes	Yes Initial	Yes	
				4x3	-	-	-	Yes	Yes Initial	Yes	Yes	
				No ID	Yes	-	Yes	Yes	Yes	Yes	Yes	
				Auto OFF	-	-	-	-	-	-	-	

Appendixes

Appendix A:

Picture Format for Each Input Source

Aspect Specifications

(Continuation)

Yes : Selectable

- : Un-selectable

Input Signal			Auto Aspect	Aspect Video ID	Aspect						
					16:9 Standard 1	16:9 Standard 2	16:9 Zoom	4:3 Standard	4:3 Expanded	4:3 Zoom 1	4:3 Zoom 2
HDMI 1 (Input1 -DVI)	HDMI (DVI)	1080p/1080i/720p	-	16x9	Yes	Yes	Yes	-	Yes	-	-
			Auto ON	16x9	Yes Initial	-	Yes	-	-	-	-
		480p 480i	Letter	-	-	-	Yes	Yes	Yes Initial	Yes	
			4x3	-	-	-	Yes	Yes Initial	Yes	Yes	
			No Info	Yes	-	Yes	Yes	Yes	Yes	Yes	
Auto OFF	-	-	-	-	-	-	-	-			
HDMI 2 (Input2 -DVI)	HDMI (DVI)	1080p/1080i/720p	-	16x9	Yes	Yes	Yes	-	Yes	-	-
			Auto ON	16x9	Yes Initial	-	Yes	-	-	-	-
		480p 480i	Letter	-	-	-	Yes	Yes	Yes Initial	Yes	
			4x3	-	-	-	Yes	Yes Initial	Yes	Yes	
			No Info	Yes	-	Yes	Yes	Yes	Yes	Yes	
Auto OFF	-	-	-	-	-	-	-	-			
HDMI Front (InputFront -DVI)	HDMI (DVI)	1080p/1080i/720p	-	16x9	Yes	Yes	Yes	-	Yes	-	-
			Auto ON	16x9	Yes Initial	-	Yes	-	-	-	-
		480p 480i	Letter	-	-	-	Yes	Yes	Yes Initial	Yes	
			4x3	-	-	-	Yes	Yes Initial	Yes	Yes	
			No Info	Yes	-	Yes	Yes	Yes	Yes	Yes	
Auto OFF	-	-	-	-	-	-	-	-			
Horizontal Expansion				16x9	105%	100%	133%	-	133%	-	-
				4x3	105%	100%	133%	75%	100%	100%	133%
Vertical Expansion					105%	100%	133%	110%	110%	133%	176%

Notes

Notes