

User's Manual

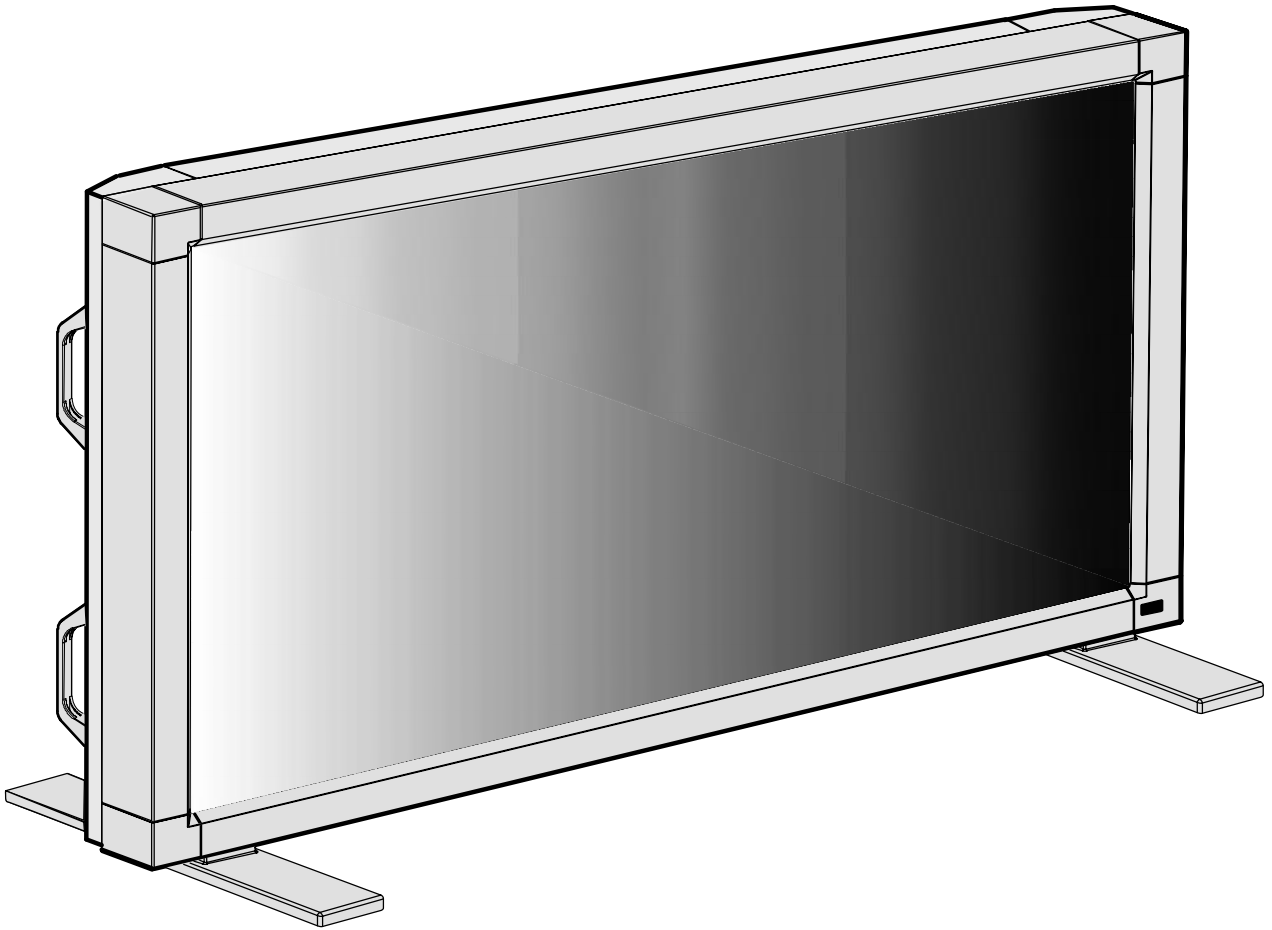

MultiSync LCD5710
57" LCD Colour Monitor

Index

Declaration of conformity	English-1
Important Information	English-2
Warning, Caution	English-2
Declaration	English-2
Safety Precautions, Maintenance & Recommended Use	English-3
Contents	English-4
Parts Name and Functions	English-5
Control Panel	English-5
Terminal Panel	English-6
Wireless Remote Control	English-7
Operating Range for the Remote Control	English-8
Handling the remote control	English-8
Setup Procedure	English-9
How to Mount and Attach Options to the LCD Monitor	English-11
Connections	English-12
Wiring Diagram	English-12
Connecting a Personal Computer	English-13
Connect the LCD Monitor to a Personal Computer	English-13
Connecting to a Macintosh Computer	English-14
Connect the LCD Monitor to Macintosh	English-14
Connecting with Digital Interface Equipment	English-15
Connect the LCD Monitor to a Computer with a Digital Output	English-15
Connecting a DVD Player with component out	English-16
Connect the LCD Monitor to a DVD Player	English-16
Connecting to a Stereo Amplifier	English-17
Connect the LCD Monitor to a Stereo Amplifier	English-17
Basic Operation	English-18
Power ON and OFF Modes	English-18
Power Indicator	English-19
Using Power Management	English-19
Selecting a video source	English-19
Picture Size	English-19
Picture Mode	English-19
Information OSM	English-19
OSM (On-Screen-Manager) Controls	English-20
PICTURE	English-20
SCREEN	English-21
AUDIO	English-22
PICTURE IN PICTURE	English-23
CONFIGURATION 1	English-23
CONFIGURATION 2	English-24
ADVANCED OPTION	English-26
Controlling the LCD monitor via RS-232C Remote Control	English-30
Features	English-32
Troubleshooting	English-33
Specifications	English-34
Mounting on Wall or Ceiling	English-35
Pin Assignment	English-36

DECLARATION OF CONFORMITY

This device complies with Part 15 of FCC Rules. Operation is subject to the following two conditions. (1) This device may not cause harmful interference, and (2) this device must accept any interference received, including interference that may cause undesired operation.

U.S. Responsible Party:	NEC Display Solutions of America, Inc.
Address:	500 Park Boulevard, Suite 1100 Itasca, Illinois 60143
Tel. No.:	(630) 467-3000

Type of Product: LCD Monitor
 Equipment Classification: Class B Peripheral
 Model: MultiSync LCD5710 (L576RX)



*We hereby declare that the equipment specified above
 conforms to the technical standards as specified in the FCC Rules.*

Windows is a registered trademark of Microsoft Corporation. NEC is a registered trademark of NEC Corporation. OmniColor is a registered trademark of NEC Display Solutions Europe GmbH in the countries of EU and Switzerland. All other brands and product names are trademarks or registered trademarks of their respective owners.

Canadian Department of Communications Compliance Statement

DOC: This Class B digital apparatus meets all requirements of the Canadian Interference-Causing Equipment Regulations.

C-UL: Bears the C-UL Mark and is in compliance with Canadian Safety Regulations according to CAN/CSA C22.2 No. 60950-1.

FCC Information

1. Use the attached specified cables with the MultiSync LCD5710 (L576RX) colour monitor so as not to interfere with radio and television reception.
 - (1) Please use the supplied power cord or equivalent to ensure FCC compliance.
 - (2) Please use the supplied shielded video signal cable, 15-pin mini D-SUB to 15-pin mini D-SUB.
 - (3) Please attach the ferrite cores on the Audio Cable. Please see page 12 of this manual.
2. This equipment has been tested and found to comply with the limits for a Class B digital device, pursuant to part 15 of the FCC Rules. These limits are designed to provide reasonable protection against harmful interference in a residential installation. This equipment generates, uses, and can radiate radio frequency energy, and, if not installed and used in accordance with the instructions, may cause harmful interference to radio communications. However, there is no guarantee that interference will not occur in a particular installation. If this equipment does cause harmful interference to radio or television reception, which can be determined by turning the equipment off and on, the user is encouraged to try to correct the interference by one or more of the following measures:
 - Reorient or relocate the receiving antenna.
 - Increase the separation between the equipment and receiver.
 - Connect the equipment into an outlet on a circuit different from that to which the receiver is connected.
 - Consult your dealer or an experienced radio/TV technician for help.

If necessary, the user should contact the dealer or an experienced radio/television technician for additional suggestions. The user may find the following booklet, prepared by the Federal Communications Commission, helpful: "How to Identify and Resolve Radio-TV Interference Problems." This booklet is available from the U.S. Government Printing Office, Washington, D.C., 20402, Stock No. 004-000-00345-4.

Important Information



WARNING



TO PREVENT FIRE OR SHOCK HAZARDS, DO NOT EXPOSE THIS UNIT TO RAIN OR MOISTURE. ALSO, DO NOT USE THIS UNIT'S POLARIZED PLUG WITH AN EXTENSION CORD RECEPTACLE OR OTHER OUTLETS UNLESS THE PRONGS CAN BE FULLY INSERTED.

REFRAIN FROM OPENING THE CABINET AS THERE ARE HIGH VOLTAGE COMPONENTS INSIDE. REFER SERVICING TO QUALIFIED SERVICE PERSONNEL.



CAUTION



CAUTION: TO REDUCE THE RISK OF ELECTRIC SHOCK, MAKE SURE POWER CORD IS UNPLUGGED FROM WALL SOCKET. TO FULLY DISENGAGE THE POWER TO THE UNIT, PLEASE DISCONNECT THE POWER CORD FROM THE AC OUTLET. DO NOT REMOVE COVER (OR BACK). NO USER SERVICEABLE PARTS INSIDE. REFER SERVICING TO QUALIFIED SERVICE PERSONNEL.



This symbol warns user that uninsulated voltage within the unit may have sufficient magnitude to cause electric shock. Therefore, it is dangerous to make any kind of contact with any part inside this unit.



This symbol alerts the user that important literature concerning the operation and maintenance of this unit has been included. Therefore, it should be read carefully in order to avoid any problems.

CAUTION: Please use the power cord provided with this display in accordance with the table below. If a power cord is not supplied with this equipment, please contact your supplier. For all other cases, please use a power cord that matches the AC voltage of the power outlet and has been approved by and complies with the safety standard of your particular country.

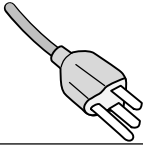
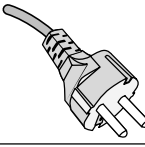
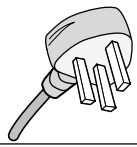
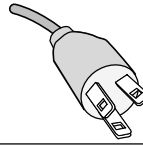
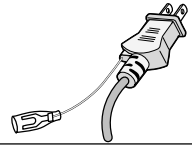
Plug Type	North America	European Continental	U.K.	Chinese	Japanese
Plug Shape					
Country	U.S.A./Canada	EU (except U.K.)	U.K.	China	Japan
Voltage	120*	230	230	220	100

*When operating the MultiSync LCD5710 monitor with its AC 125-240V power supply, use a power supply cord that matches the power supply voltage of the AC power outlet being used.

Declaration

Declaration of the Manufacturer

We hereby certify that the colour monitor MultiSync LCD5710 (L576RX) is in compliance with

Council Directive 73/23/EEC:

– EN 60950-1

Council Directive 89/336/EEC:

– EN 55022

– EN 61000-3-2

– EN 61000-3-3

– EN 55024

and marked with



NEC Display Solutions, Ltd.

4-13-23, Shibaura,

Minato-Ku

Tokyo 108-0023, Japan

WEEE Mark (European Directive 2002/96/EC)



Within the European Union

EU-wide legislation, as implemented in each Member State, requires that waste electrical and electronic products carrying the mark (left) must be disposed of separately from normal household waste. This includes monitors and electrical accessories, such as signal cables or power cords. When you need to dispose of your NEC display products, please follow the guidance of your local authority, or ask the shop where you purchased the product, or if applicable, follow any agreements made between yourself and NEC.

The mark on electrical and electronic products only applies to the current European Union Member States.

Outside the European Union

If you wish to dispose of used electrical and electronic products outside the European Union, please contact your local authority so as to comply with the correct disposal method.

Safety Precautions, Maintenance & Recommended Use

FOR OPTIMUM PERFORMANCE, PLEASE NOTE THE FOLLOWING WHEN SETTING UP AND USING THE MULTISYNC LCD5710 LCD COLOUR MONITOR:

- **DO NOT OPEN THE MONITOR.** There are no user serviceable parts inside and opening or removing covers may expose you to dangerous shock hazards or other risks. Refer all servicing to qualified service personnel.
- Do not spill any liquids into the cabinet or use your monitor near water.
- Do not insert objects of any kind into the cabinet slots, as they may touch dangerous voltage points, which can be harmful or fatal or may cause electric shock, fire or equipment failure.
- Do not place any heavy objects on the power cord. Damage to the cord may cause shock or fire.
- Do not place this product on a sloping or unstable cart, stand or table, as the monitor may fall, causing serious damage to the monitor.
- The power supply cord you use must have been approved by and comply with the safety standards of your country. (Type H05VV-F 3G 1mm² should be used in Europe)
- In UK, use a BS-approved power cord with molded plug having a black (13A) fuse installed for use with this monitor.
- Do not place any objects onto the monitor and do not use the monitor outdoors.
- The lamps in this product contain mercury. Please dispose according to state, local or federal law.
- Do not bend power cord.
- Do not use monitor in high temperature, humid, dusty, or oily areas.
- If monitor or glass is broken, handle with care. Do not come in contact with the liquid crystal.
- Allow adequate ventilation around the monitor, so that heat can properly dissipate. Do not block ventilated openings or place the monitor near a radiator or other heat sources. Do not put anything on top of the monitor.
- The power cable connector is the primary means of detaching the system from the power supply. The monitor should be installed close to a power outlet, which is easily accessible.
- Handle with care when transporting. Save packaging for transporting.
- Please clean the holes of back cabinet to remove dirt and dust at least once a year because of set reliability.
- If using the cooling fan continuously, it's recommended to wipe ventilation holes a minimum of once a month.

Immediately unplug your monitor from the wall outlet and refer servicing to qualified service personnel under the following conditions:

- When the power supply cord or plug is damaged.
- If liquid has been spilled, or objects have fallen into the monitor.
- If the monitor has been exposed to rain or water.
- If the monitor has been dropped or the cabinet damaged.
- If the monitor does not operate normally by following operating instructions.

Recommended Use

- For optimum performance, allow 20 minutes for warm-up.
- Rest your eyes periodically by focusing on an object at least 5 feet away. Blink often.
- Position the monitor at a 90° angle to windows and other light sources to minimize glare and reflections.
- Clean the LCD monitor surface with a lint-free, non-abrasive cloth. Avoid using any cleaning solution or glass cleaner!
- Adjust the monitor's brightness, contrast and sharpness controls to enhance readability.
- Avoid displaying fixed patterns on the monitor for long periods of time to avoid image persistence (after image effects).
- Get regular eye checkups.



Ergonomics

To realize the maximum ergonomic benefits, we recommend the following:

- Use the preset Size and Position controls with standard signals.
- Use the preset Colour Setting.
- Use non-interlaced signals.
- Do not use primary colour blue on a dark background, as it is difficult to see and may produce eye fatigue due to insufficient contrast.

Contents

Your new MultiSync LCD5710 monitor box* should contain the following:

- LCD monitor
- Power Cord
- Video Signal Cable
- User's Manual
- Wireless Remote Control and AA Batteries
- Clamp x 3
- Screw (M4 x 8) x 4
- CD-ROM
- Band x 2 
- Ferrite Core x 2 
- Speaker Plug x 1set  (Required for optional Loudspeakers)
- Stand x 2
- Thumbscrew for stand x 2

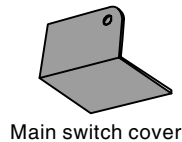
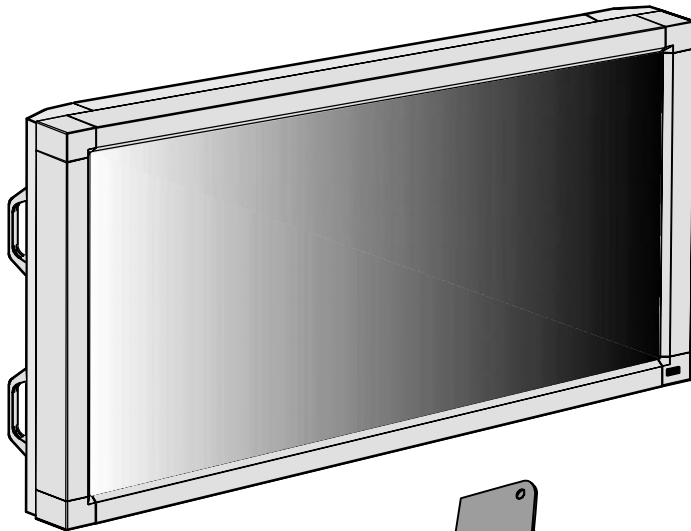

Main switch cover

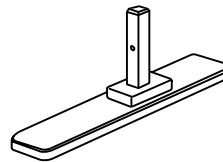

Stand x 2



Thumbscrew for stand x 2

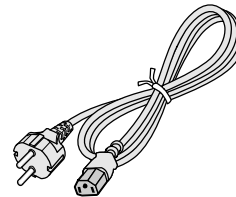

Power Cord
(Type of power cord included will depend on the where the LCD monitor is to be shipped)

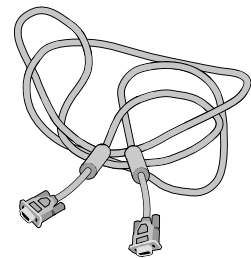

Video Signal Cable
(D-SUB to D-SUB Cable)

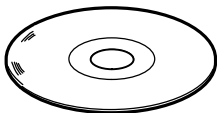

CD-ROM



User's Manual



Screw (M4 x 8) x 4



Clamp x 3



 Speaker Plug x 1set
(Required for optional Loudspeakers)
(Attached on external speaker terminal)

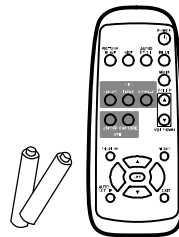

Wireless Remote Control
and AA Batteries



Ferrite Core x 2 



Band x 2 

- * If stands are to be used, install them as the monitor is unpacked.
- * Remember to save your original box and packing material to transport or ship the monitor.

The following components are optional.

- External Speaker Unit

 Denotes an AV unit function.
All AV functions are enabled when the AV unit is installed.
If this product was purchased in Europe the AV unit is preinstalled and all AV functions are available.

Parts Name and Functions

Control Panel

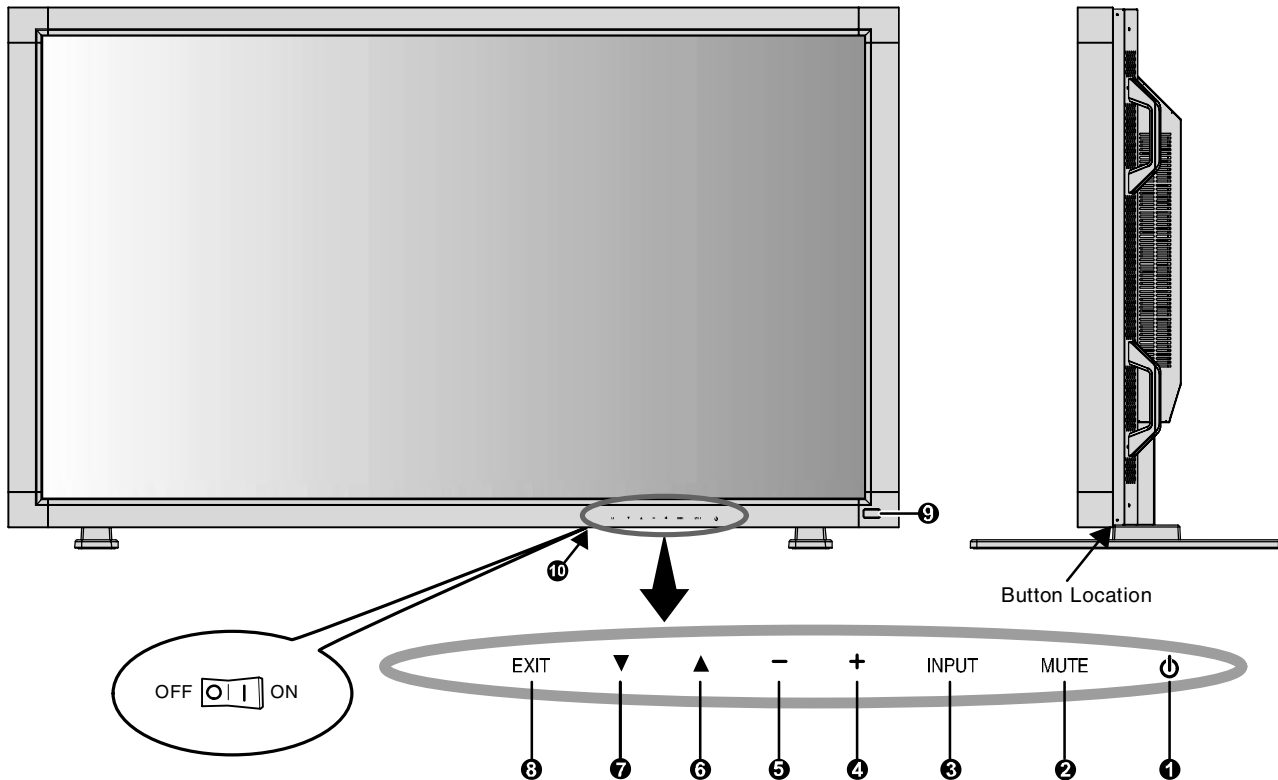

① POWER button (⏻)

Switches the power on/off. See page 18.

② MUTE button ^{AV}

Switches the audio mute ON/OFF.

③ INPUT button

Acts as SET button within OSM menu. (Toggle switches between [RGB1], [RGB2], [RGB3], [DVD/HD], [VIDEO] or [VIDEO<S>]).

^{AV} [DVD/HD] and [VIDEO] inputs are enabled when the AV-unit option is installed.

[VIDEO<S>] is enabled by selecting the "SEPARATE" mode in the OSM or by having the "S-VIDEO" cable connected with the "S-VIDEO" signal present and selecting "PRIORITY" MODE. See page 26.

④ PLUS (+) button

Acts as (+) button to increase the adjustment with OSM menu.

^{AV} Increases the audio output level when the OSM menu is turned off.

⑤ MINUS (-) button

Acts as (-) button to decrease the adjustment with OSM menu.

^{AV} Decreases the audio output level when the OSM menu is turned off.

⑥ UP (▲) button

Activates the OSM menu when the OSM menu is turned-off. Acts as ▲ button to move the highlighted area up to select the adjustment with OSM menu.

⑦ DOWN (▼) button

Activates the OSM menu when the OSM menu is turned-off. Acts as ▼ button to move the highlighted area down to select the adjustment with OSM menu.

⑧ EXIT button

Activates the OSM menu when the OSM menu is turned-off. Acts as EXIT button to move to previous menu with OSM menu.

⑨ Remote control sensor and Power Indicator

Receives the signal from the remote control (when using the wireless remote control). See page 8.

Glow green when the LCD monitor is in active mode and glows red when the LCD monitor is in POWER OFF mode.

When the LCD monitor is in POWER SAVE mode, it will glow both green and red. When SCHEDULE is enabled, it will blink green and glow red. See page 19.

In the case of where a failure is detected, it will blink red.

⑩ Main Power Switch

On/off Switch to turn main power on/off.

Control Key Lock Mode

This control completely locks out access to all Control Key functions. To activate the control key lock function, press both ▼ and ▲ and hold down simultaneously for more than 3 seconds. To resume back to user mode, press both of ▼ and ▲ and hold simultaneously for more than 3 seconds.

^{AV} Denotes an AV unit function.

All AV functions are enabled when the AV unit is installed.

If this product was purchased in Europe the AV unit is preinstalled and all AV functions are available.

Terminal Panel

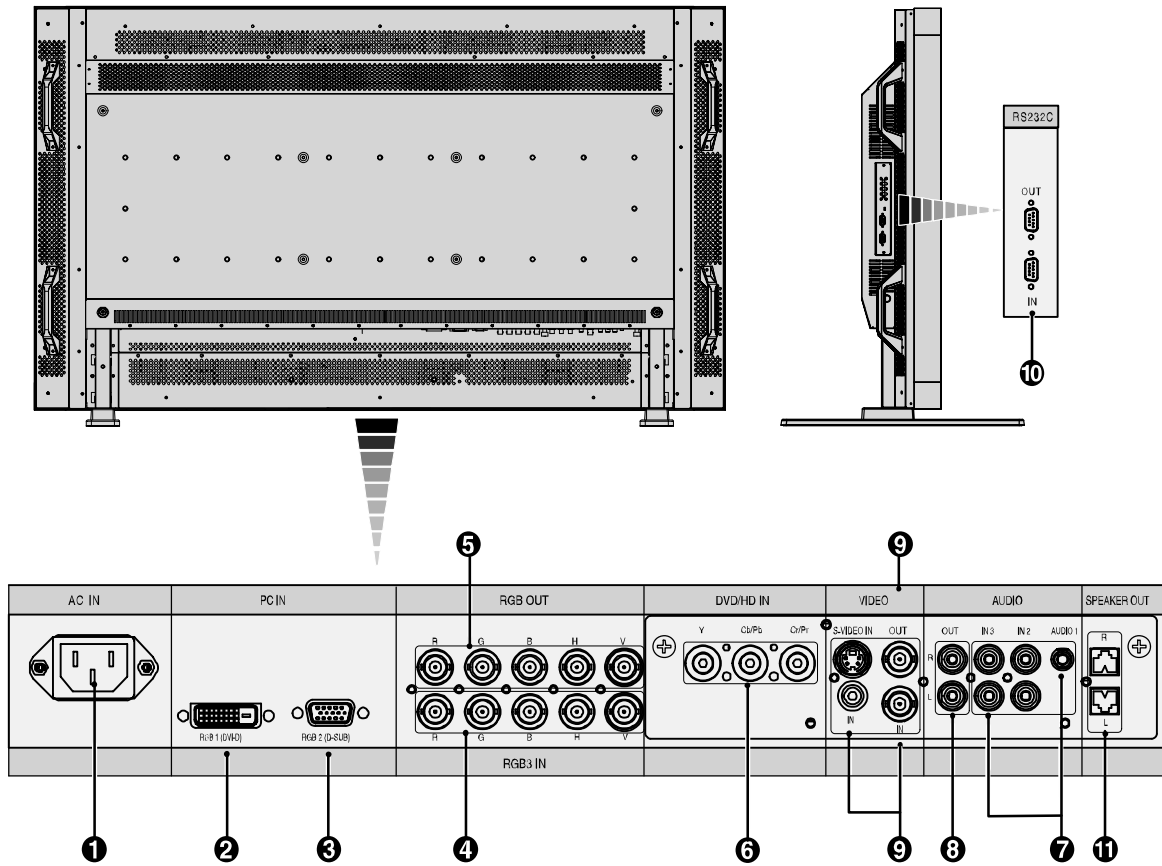

1 AC IN connector

Connects with the supplied power cord.

2 RGB 1 IN (DVI-D)

To input digital RGB signals from a computer or HDTV device having a digital RGB output.

* This connector does not support analog input.

3 RGB 2 IN (mini D-Sub 15 pin)

To input analog RGB signals from a personal computer or other RGB equipment.

4 RGB 3 [R, G, B, H, V] (BNC)

IN connector: To input analog RGB signals or signals from other RGB equipment.

This is also to connect equipment such as a DVD player and HDTV laser disk player. A Sync-on-Green signal can be connected to the G connector.

5 RGB OUT connector (BNC)

To output the signal from RGB 3.

6 DVD/HD connector (BNC) ^{AV}

Connecting equipment such as a DVD player, HDTV device, or Laser disc player.

7 AUDIO IN 1, 2, 3 ^{AV}

To input audio signal from external equipment such as a computer, VCR or DVD player.

8 AUDIO OUT ^{AV}

To output the audio signal from the AUDIO IN 1, 2 and 3 jack.

9 VIDEO INPUT/OUTPUT Connector ^{AV}

VIDEO IN connector (BNC and RCA): To input a composite video signal. BNC and RCA connectors are not available at the same time. (Use only one input).

VIDEO OUT connector (BNC): To output the composite video signal from the VIDEO IN connector.

S-VIDEO IN connector (DIN 4 pin): To input the S-video (Y/C separate signal). See page 26, S-VIDEO MODE SETTING.

10 EXTERNAL CONTROL (D-Sub 9 pin)

IN connector: Use when operating the LCD monitor from the RGB equipment like a computer.

Out connector: To connect multiple MultiSync LCD5710 monitors.

11 EXTERNAL SPEAKER TERMINAL ^{AV}

To output the audio signal from AUDIO 1, 2 or 3 jack.

^{AV} Denotes an AV unit function.

All AV functions are enabled when the AV unit is installed.

If this product was purchased in Europe the AV unit is preinstalled and all AV functions are available.

Wireless Remote Control

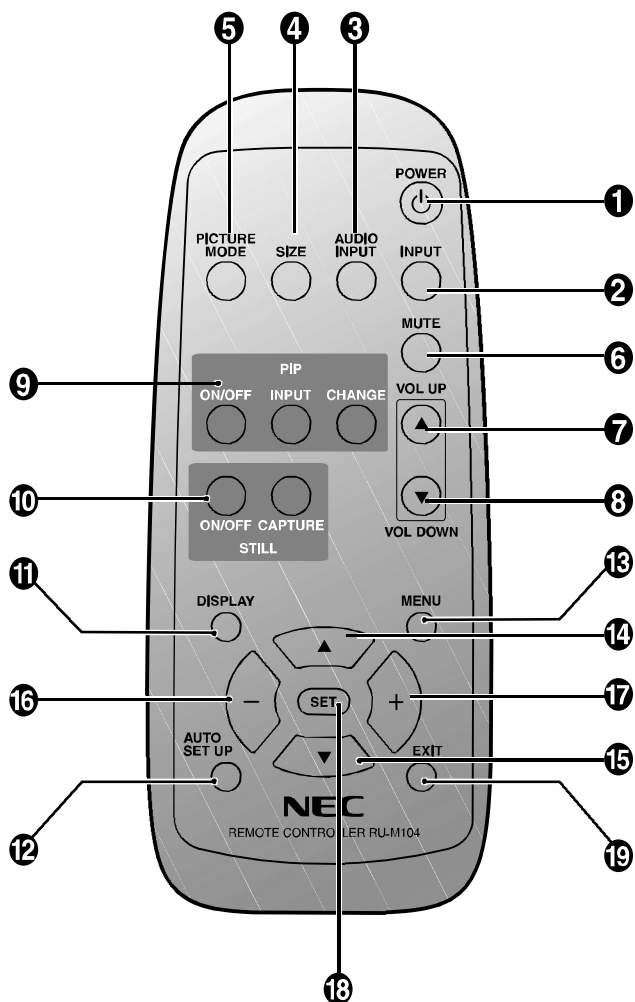

1 POWER button

Switches the power on/off.

* If Power Indicator is not glowing, then no controls will work.

2 INPUT button

Selects from input signal, [RGB1], [RGB2], [RGB3], [DVD/HD], [VIDEO] or [VIDEO<S>].

[DVD/HD] and [VIDEO] inputs are enabled when the AV-unit option is installed.

[VIDEO<S>] is enabled by selecting the "SEPARATE" mode in the OSM or by having the "S-VIDEO" cable connected with the "S-VIDEO" signal present and selecting "PRIORITY" MODE. See page 26.

3 AUDIO INPUT button

Selects from input audio signal, [AUDIO1], [AUDIO2], [AUDIO3].

4 SIZE button

Selects picture size, [FULL], [NORMAL], [WIDE] and [ZOOM]. See page 19.

5 PICTURE MODE button

Selects picture mode, [HIGHBRIGHT], [STANDARD], [sRGB], [CINEMA]. See page 19.

HIGHBRIGHT: for moving images such as DVD

STANDARD: for images

sRGB: for text based images

CINEMA: for movies.

6 MUTE button

To switch the mute function on/off.

7 VOLUME UP button

Increases the audio output level.

8 VOLUME DOWN button

Decreases the audio output level.

9 PIP (Picture In Picture) button

ON/OFF button: Toggle switches between PIP, POP, side-by-side (aspect) and side-by-side (full). See page 23.
 INPUT button: Selects the "picture in picture" input signal.
 CHANGE button: Replaces to the main picture and sub picture.

NOTE: The PIP function does not support 1080i input signals. If a 1080i signal is used for PIP, then the sub picture on the screen will be blank. The PIP function will work with 1080p signals.

10 STILL button

ON/OFF button: To switch the still picture mode on/off.

CAPTURE button: Captures the new picture.

NOTE: The STILL button does not work when pixel clock is greater than 108MHz and also not work for 1080i.

11 DISPLAY button

To switch the information OSM on/off. See page 19.

12 AUTO SETUP button

To enter the auto setup menu. See page 23.

13 MENU button

To switch the menu mode on/off.

14 UP button

Acts as ▲ button to move the highlighted area up to select the adjustment with OSM menu.

Small screen which adjusted "PIP" mode moves up.

15 DOWN button

Acts as ▼ button to move the highlighted area down to select the adjustment with OSM menu.

Small screen which adjusted "PIP" mode moves down.

16 MINUS button decrease

Acts as (-) button to decrease the adjustment with OSM menu.

Small screen which adjusted "PIP" mode moves left.

17 PLUS button increase

Acts as (+) button to increase the adjustment with OSM menu.

Small screen which adjusted "PIP" mode moves right.

18 SET button

Acts as SET button with OSM menu.

19 EXIT button

Turn to previous menu with OSM menu.

Denotes an AV unit function.

All AV functions are enabled when the AV unit is installed.

If this product was purchased in Europe the AV unit is preinstalled and all AV functions are available.

Operating Range for the Remote Control

Point the top of the remote control toward the LCD monitor's remote sensor during button operation.

Use the remote control within a distance of about 7 m/23 ft. from the front of the LCD monitor's remote control sensor and at a horizontal and vertical angle of within 30° within a distance of about 3 m/10 ft.

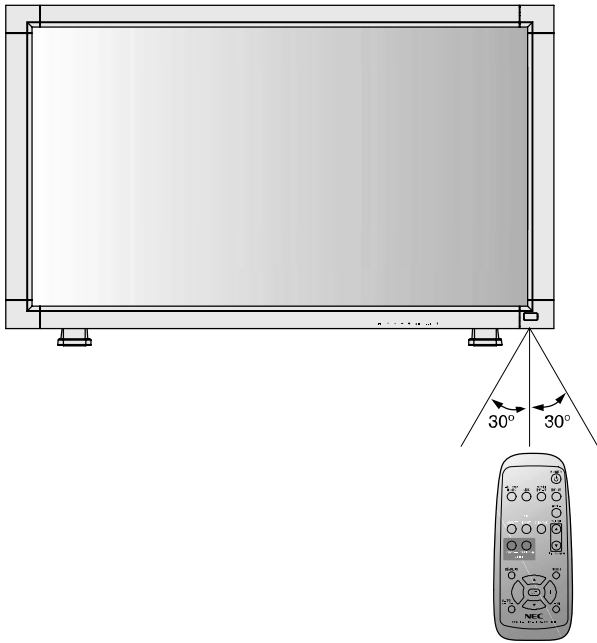

Handling the remote control

- * Do not subject to strong shock.
- * Do not allow water or other liquid to splash the remote control. If the remote control gets wet, wipe it dry immediately.
- * Avoid exposure to heat and steam.
- * Other than to install the batteries, do not open the remote control.

Caution: The remote control system may not function when direct sunlight or strong illumination strikes the remote control sensor of the LCD monitor, or when there is an object in the path.

Setup Procedure

1. Determine the installation location

CAUTION: DO NOT ATTEMPT TO INSTALL THE LCD MONITOR BY YOURSELF.

Installing your LCD display must be done by a qualified technician. Contact your dealer for more information.

CAUTION: MOVING OR INSTALLING THE LCD MONITOR MUST BE DONE BY TWO OR MORE PEOPLE. It is recommended that 4 people move or install the LCD Monitor, due to its weight of almost 66.0kg (145.5lbs).

Failure to follow this caution may result in injury if the LCD monitor falls.

CAUTION: Do not mount or operate the display upside down, face up, or face down.

CAUTION: This LCD has a temperature sensor and cooling fan. If the LCD becomes too hot, the cooling fan will turn on automatically. If the LCD becomes overheated and the cooling fan is running, the "Caution" menu will appear. If the "Caution" menu appears, discontinue use and allow the unit to cool. When the LCD monitor is used in an enclosure or with protection on the LCD surface, please check the inside temperature of monitor in the "HEAT STATUS" menu (See page 28). If the temperature is hotter than normal, turn the "cooling fan" function to ON in the SCREEN SAVER OSM (See page 24).

IMPORTANT: Lay the protective sheet, which was wrapped around the LCD monitor when it was packaged, beneath the LCD monitor so as not to scratch the panel.

2. Install the remote control batteries

The remote control is powered by 1.5V AA batteries. To install or replace batteries:

1. Press and slide to open the cover.
2. Align the batteries according to the (+) and (-) indications inside the case.
3. Replace the cover.

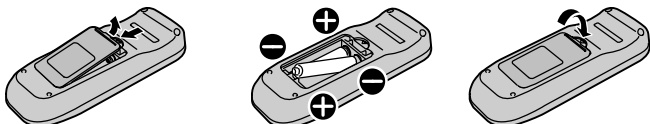

CAUTION: Incorrect use of batteries can result in leaks or bursting.

Be careful especially about the following points.

- Place "AA" size batteries matching the + and - signs on each battery to the + and - signs of the battery compartment.
- Don't mix battery types.
- Don't combine new batteries with used ones. It causes shorter battery life or leakage of batteries.

- Remove dead batteries immediately to prevent battery liquid from leaking into the battery compartment. Don't touch exposed battery acid, it cause damage to your skin.

NOTE: If you do not intend to use the Remote Control for a long period, remove the batteries.

3. Connect external equipment (See pages 12-17)

- To protect the connected equipment, turn off the main power before making connections.
- Refer to your equipment user manual.

4. Connect the supplied power cord

- The power outlet socket should be installed as near to the equipment as possible, and should be easily accessible.
- Fully insert the prongs into the power outlet socket. Loose connection may cause noise.
- Please attach power cord to the LCD monitor using the screw and clamp (included).

NOTE: Please refer to "Important Information" section of this manual for proper selection of AC power cord.

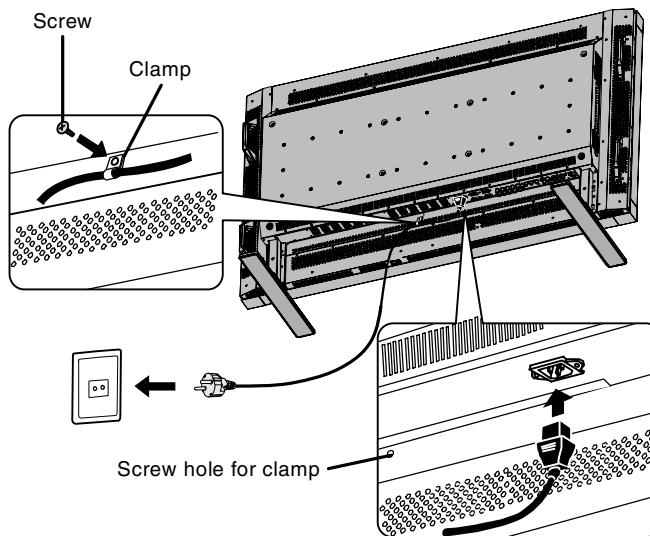

5. Switch on the power of all attached external equipment

When connected with a computer, switch on the power of the computer first.

6. Operate the attached external equipment

Displays the desired signal from the external equipment.

7. Adjust the sound

Makes adjustments when required.

8. Adjust the screen (See pages 20-28)

Makes required adjustments to the screen display position or if there is distortion.

9. Adjust the image (See pages 20-28)

Make adjustments to picture such as the brightness or contrast when required.

10. Recommended Adjustment

To reduce the risk of "image persistence", please adjust the following items based on the application being used.

"SCREEN SAVER" (See page 24), "SIDE BORDER COLOR" (See page 24), "DATE & TIME" (See page 28), "SCHEDULE" (See page 28).

11. Installing and removing stand

CAUTION: Installing and removing the stand must be done by two or more people. It is recommended that 4 people install and remove the stand, due to its weight of almost 66.0kg (145.5lbs).

How to install stand

1. Please turn monitor off.
2. Place stand onto monitor with the long ends of the feet in front of the monitor.
3. After inserting stand in guide block, fasten thumbscrews on both sides of the monitor.

How to remove the stand

1. Spread the protective sheet on the flat surface, such as a desk.
2. Place monitor on the protective sheet.
3. Remove thumbscrews with a screwdriver or with your fingers and place them in a safe place for reuse.

Thumbscrews

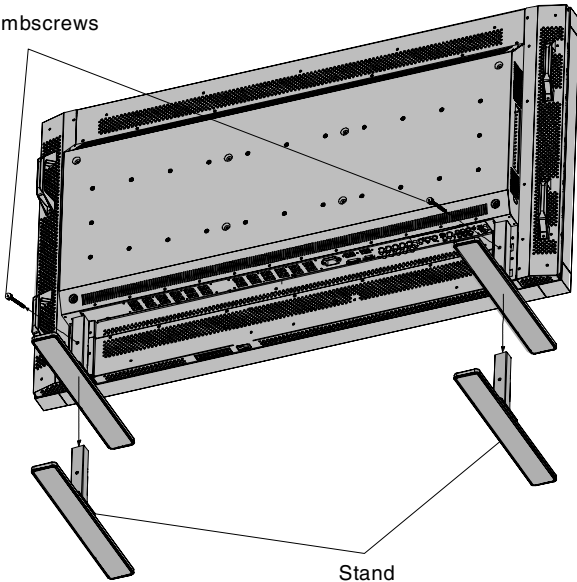

CAUTION: Handle with care when mounting the display stand and avoid pinching your fingers.

NOTE: Place stand onto monitor so that the long end of the feet are in the front.

12. When using external speakers

We recommend to using the optional speakers designed for the MultiSync LCD5710.

The external speaker terminals of the MultiSync LCD5710 may be connected to standard speakers. To do so, the speaker wires must first be fitted with the attached speaker plugs.

How to use the attached speaker plug

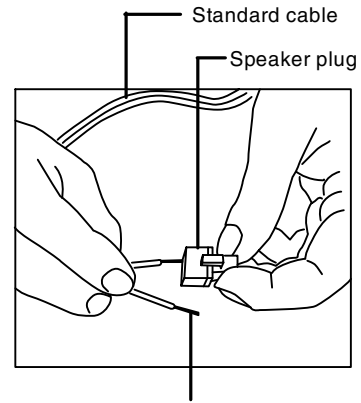

Insert the negative (-) side of a standard speaker cable into the negative (-) side of the speaker plug. The negative side of a standard speaker cable has a stripe running the length of the cable. Insert remaining wire into the positive (+) side of the speaker plug. Hold down on the small lever on the speaker plug to insert cable.

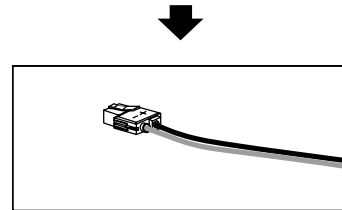

Fixed cable and speaker plug.

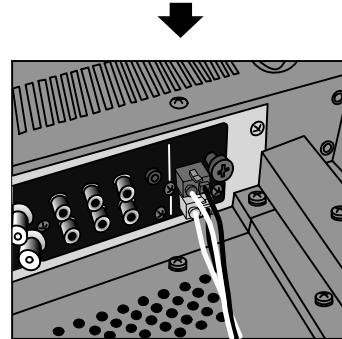

Insert the fixed cable and speaker plug to the speaker terminal.

 Denotes an AV unit function.

All AV functions are enabled when the AV unit is installed.

If this product was purchased in Europe the AV unit is preinstalled and all AV functions are available.

How to Mount and Attach Options to the LCD Monitor

You can attach mounting accessories to the LCD monitor in one of the following two ways:

1. In the upright position

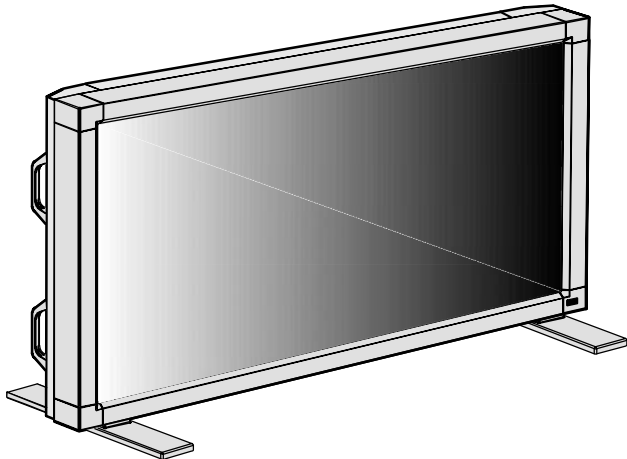

2. Lay the screen face down

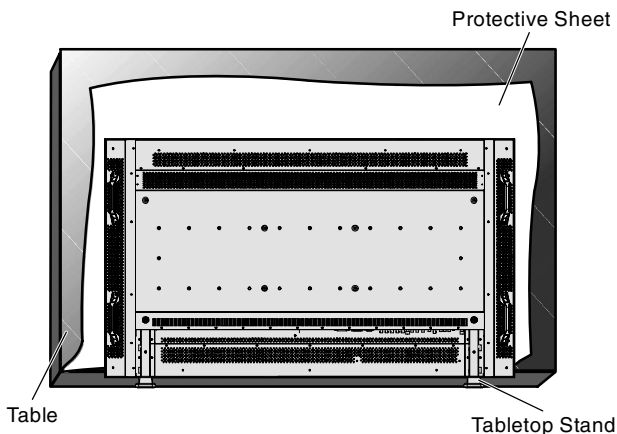

Lay the protective sheet which was wrapped around the monitor when it was packaged, on a table, beneath the screen surface so as not to scratch the screen face.

This device cannot be used or installed without the Tabletop Stand or other mounting accessory. Failure to follow correct mounting procedures could result in damage to the equipment or injury to the user or installer. Product warranty does not cover damage caused by improper installation. Failure to follow these recommendations could result in voiding your warranty.

Please refer to "Mounting on Wall or Ceiling" section when you mount your monitor on Wall or Ceiling. See page 35.

3. Ventilation Requirements for enclosure mounting

To allow heat to disperse, leave space between surrounding objects as shown in the diagram below.

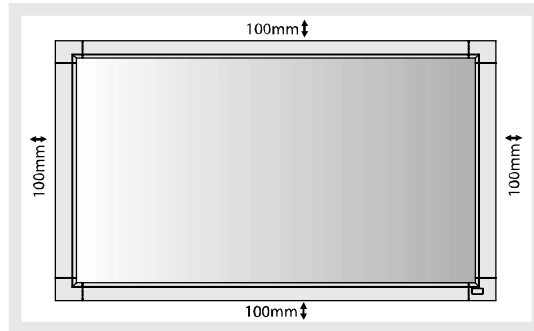

4. To avoid falling down

Fasten the LCD monitor to wall using a cord or chain, which is sufficient to support the weight of the LCD monitor (approx. 66.0kg (145.5lbs)). The wall must be strong enough to support the monitor and mounting accessories.

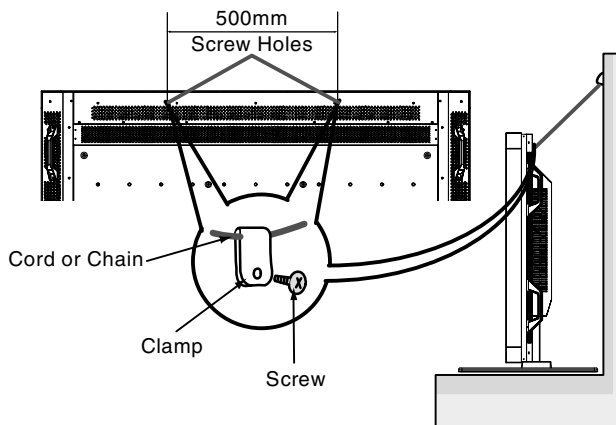

Before moving the LCD monitor, the cord or chain should be removed.

5. To prevent the main power switch from being changed

To prevent use of the main power switch, please attach the main switch cover, which is enclosed as an accessory.

NOTE: With the main power switch cover in place, the main power switch cannot be turned off. Remove main power switch cover in order to switch off the display.

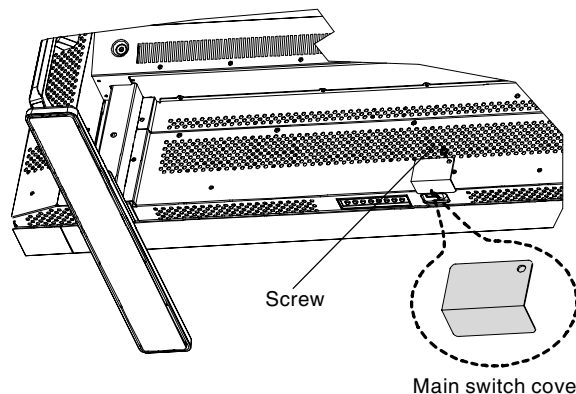

Connections

Before making connections:

- * First turn off the power of all the external equipment and then make the necessary connections.
- * Refer to the user manual included with each separate piece of equipment.

Wiring Diagram

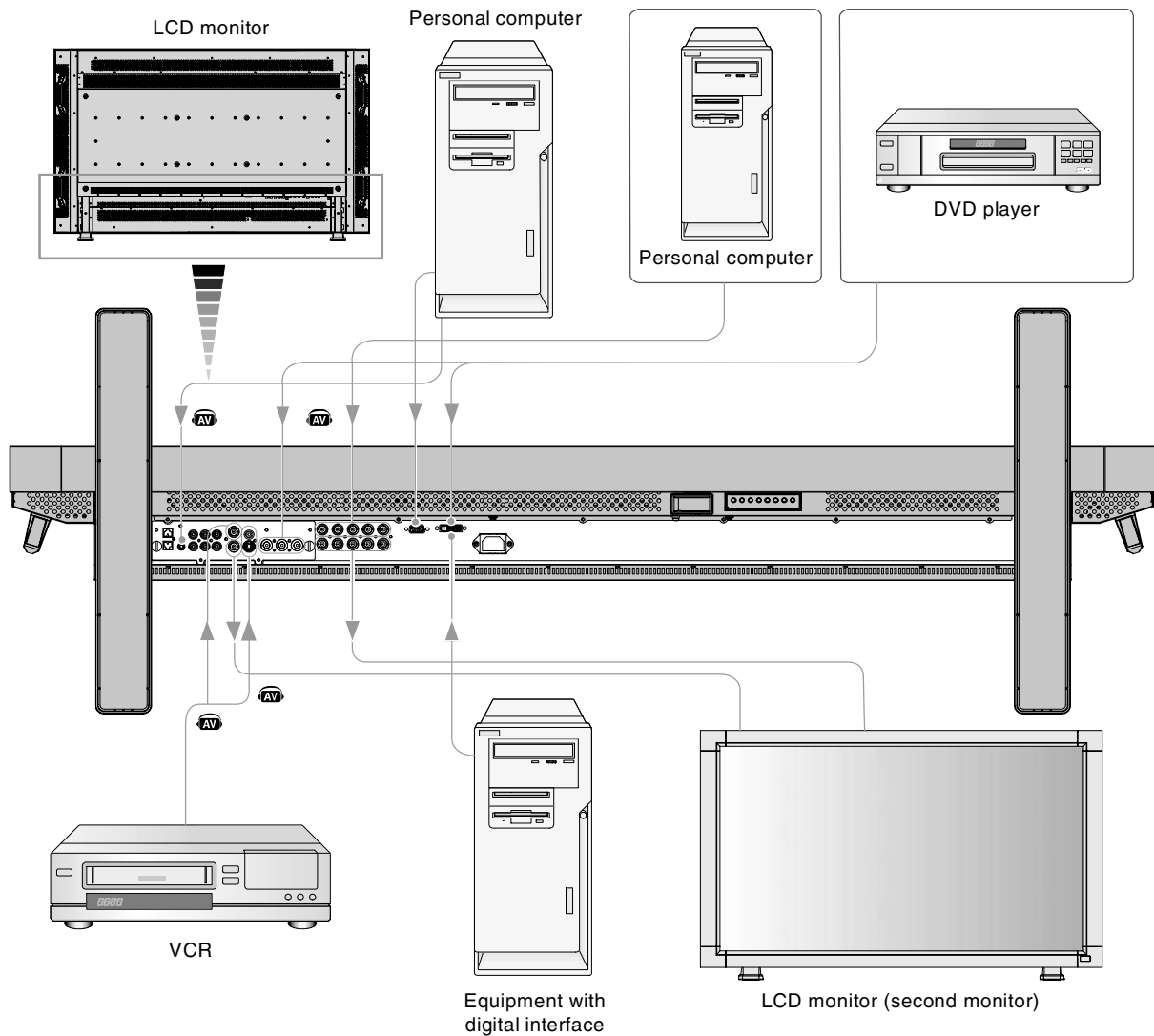

Attaching the Ferrite Core ^{AV}

Attach the Ferrite Core to PC Audio Cable.
Use of the cable without mounting the ferrite core will result in the occurrence of noise.

For PC Audio Cable

- 1 Open the ferrite core and clamp it on the PC Audio cable.
- 2 Close the ferrite core.

Ferrite Core

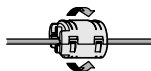
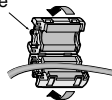

Mounting Position of Ferrite Core ^{AV}

Attach the two Ferrite Cores to the both ends of PC Audio Cable.

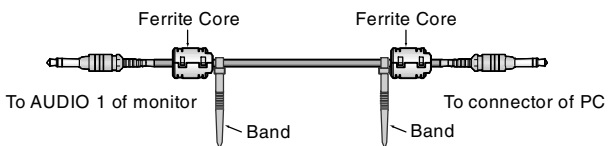

^{AV} Denotes an AV unit function.

All AV functions are enabled when the AV unit is installed.

If this product was purchased in Europe the AV unit is preinstalled and all AV functions are available.

Connecting a Personal Computer

Connecting your computer to your LCD monitor will enable you to display your computer's screen image. Some video cards and pixel clock over 165MHz may not display an image correctly. Your LCD monitor displays proper image by adjusting the factory preset timing signal automatically.

<Factory preset signal timing>

Resolution	Scanning frequency		Remarks
	Horizontal	Vertical	
640 x 480	31.5kHz	60Hz	
800 x 600	37.9kHz	60Hz	
1024 x 768	48.4kHz	60Hz	
1280 x 768	48kHz	60Hz	
1360 x 768	48kHz	60Hz	
1280 x 1024	64kHz	60Hz	
1600 x 1200	75kHz	60Hz	Compressed image
1920 x 1080	67.5kHz	60Hz	Recommended resolution

Connect the LCD Monitor to a Personal Computer

- To connect the RGB 2 IN connector (mini D-sub 15 pin) on the LCD monitor, use the supplied PC - Video RGB signal cable (mini D-sub 15 pin to mini D-sub 15 pin).
- To connect the RGB 3 connector (BNC) on the LCD monitor, use a mini D-sub 15 pin to BNC x 5 signal cable (not included). Select RGB 3 from the INPUT button.
- When connecting one or more LCD monitors, use the RGB OUT connector (BNC).
- The AUDIO IN 1, 2 and 3 can be used for audio input. For connection, select AUDIO 1, 2 or 3 from the AUDIO INPUT button. 

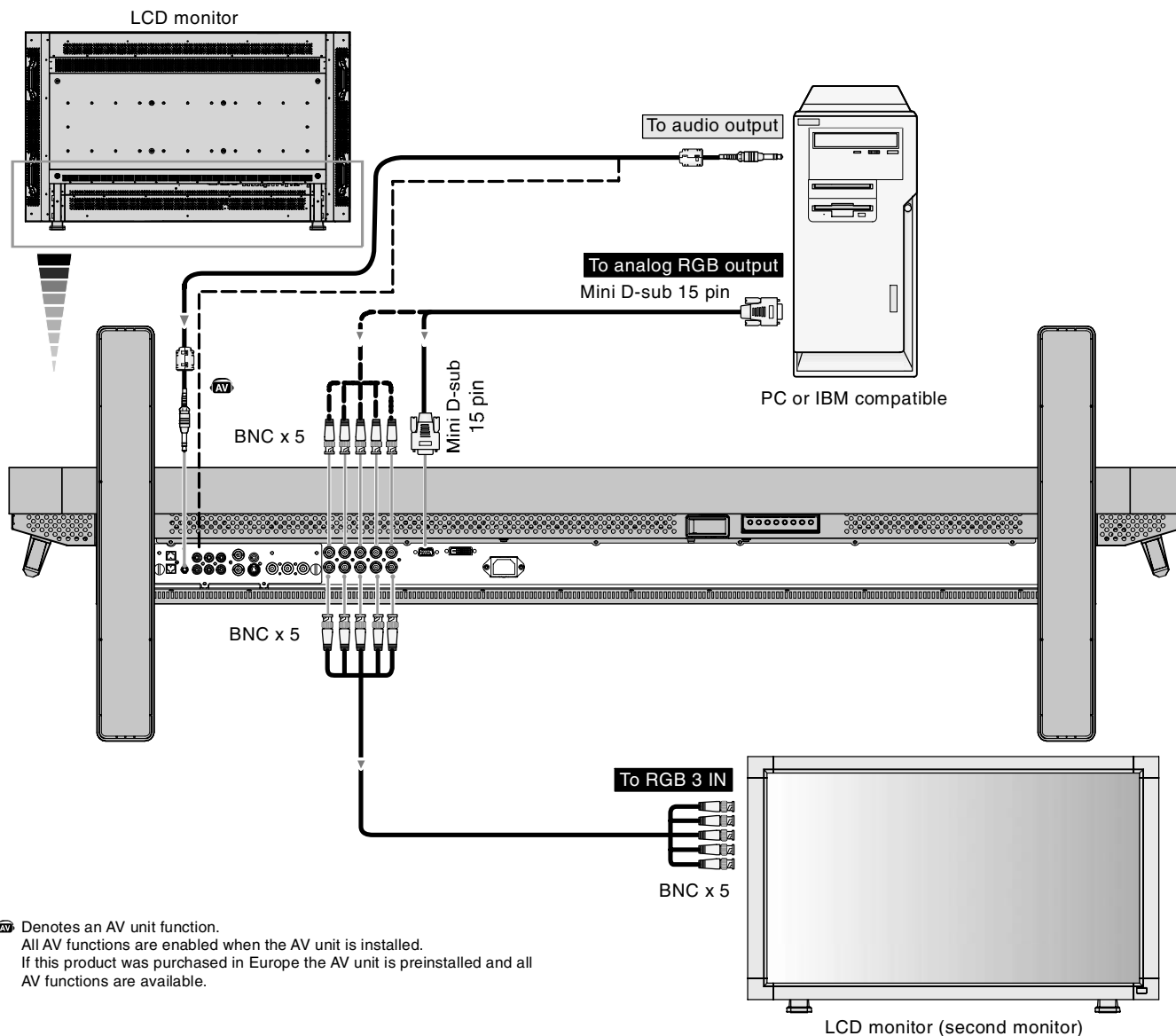

 Denotes an AV unit function. All AV functions are enabled when the AV unit is installed. If this product was purchased in Europe the AV unit is preinstalled and all AV functions are available.

Connecting to a Macintosh Computer

Connecting your Macintosh computer to your LCD monitor will enable you to display your computer's screen image. Some video cards or drivers may not display images correctly.

Connect the LCD Monitor to Macintosh

- To connect the RGB 2 IN connector (mini D-sub 15 pin) on the LCD monitor, use the supplied PC - Video RGB signal cable (mini D-sub 15 pin to mini D-sub 15 pin).
- To connect the RGB 3 IN connector (BNC) on the LCD monitor, use the signal cable available separately (mini D-sub 15 pin to BNC x 5).
- If you use with a Macintosh PowerBook, set "Mirroring" to Off.
Refer to your Macintosh's owner's manual for more information about your computer's video output requirements and any special identification or configuring your monitor's image and monitor may require.
- The AUDIO IN 1, 2 and 3 can be used for audio input. For connection, select AUDIO 1, 2 or 3 from the AUDIO INPUT button. 

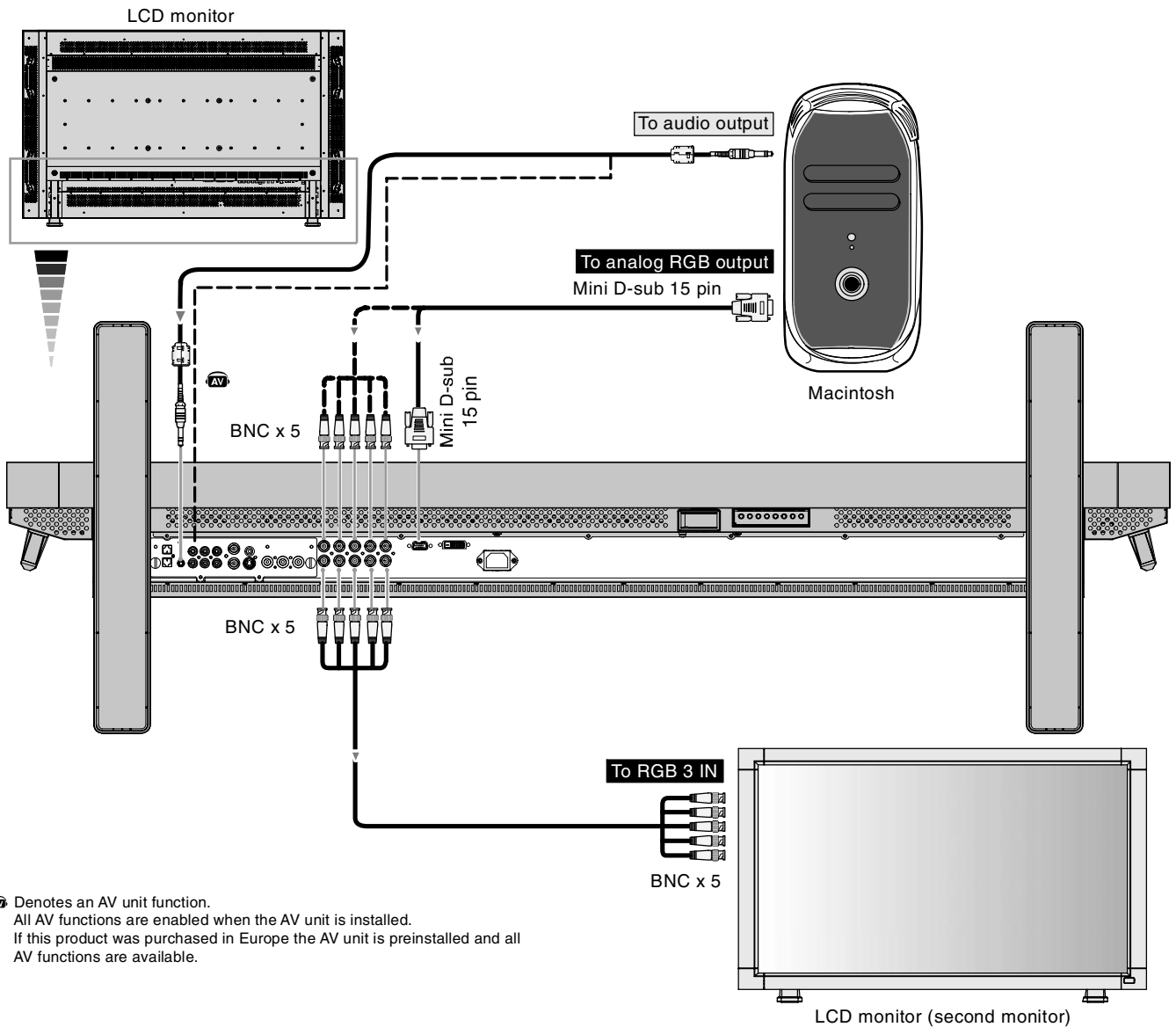

 Denotes an AV unit function.
All AV functions are enabled when the AV unit is installed.
If this product was purchased in Europe the AV unit is preinstalled and all AV functions are available.

Connecting with Digital Interface Equipment

Connections can be made with equipment with a digital interface that is compliant with the DVI (Digital Visual Interface) standard.

Connect the LCD Monitor to a Computer with a Digital Output

- The RGB 1 IN connector also accepts a DVI-D cable.
- Input TMDS signals conforming to DVI standards.
- To maintain display quality, use a cable with a quality prescribed by DVI standards.
- The AUDIO IN 1, 2 and 3 can be used for audio input. For connection, select AUDIO 1, 2 or 3 from the AUDIO INPUT button. 
- Mode selection, see “DVI MODE” of page 25.

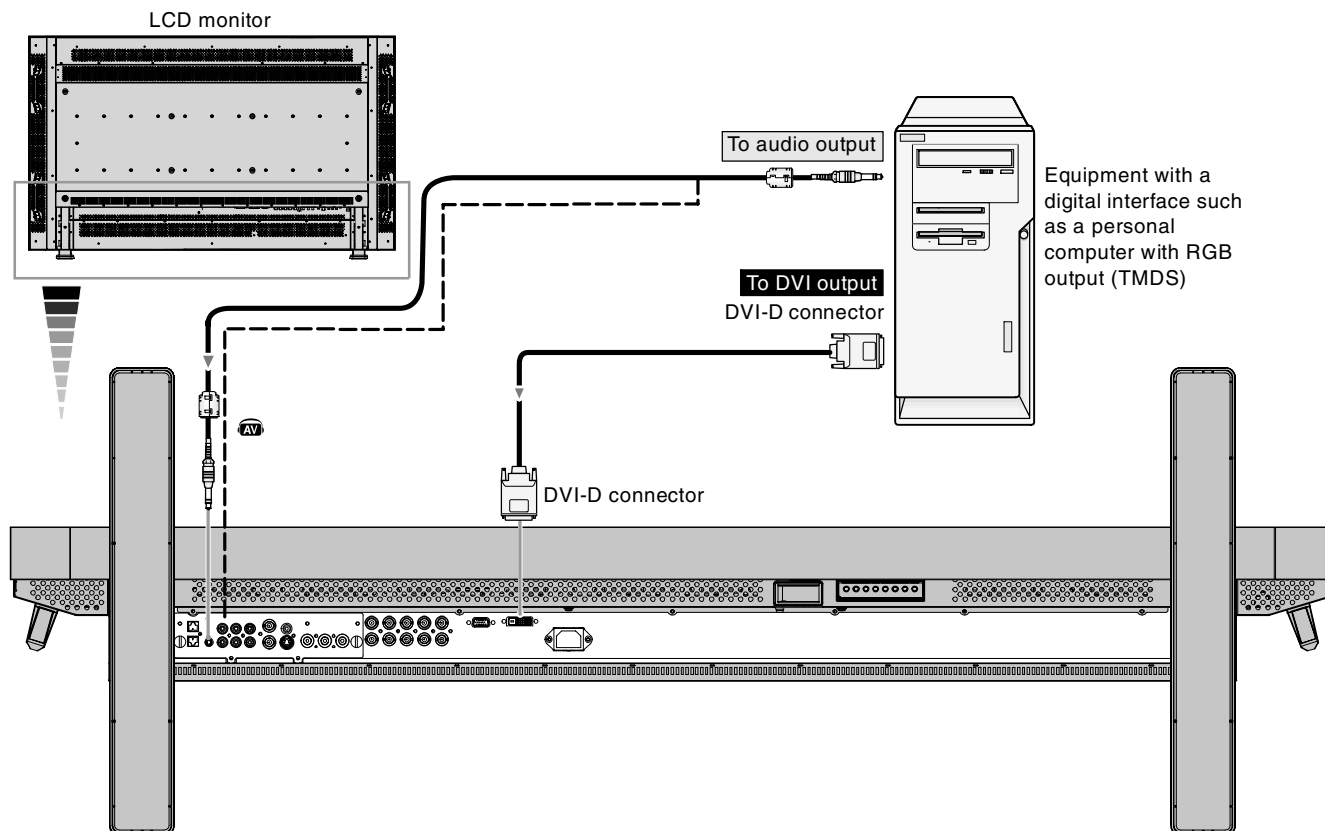

 Denotes an AV unit function.

All AV functions are enabled when the AV unit is installed.

If this product was purchased in Europe the AV unit is preinstalled and all AV functions are available.

Connecting a DVD Player with component out

Connecting your DVD player to your LCD monitor will enable you to display DVD video.

Refer to your DVD player user's manual for more information.

Connect the LCD Monitor to a DVD Player

- To connect the DVD/HD IN connector (BNC) on the LCD monitor, use a BNC connector cable (not included) You will need a BNC-to-RCA adapter to connect a DVD player with an RCA pin jack to the BNC connector cable (not included).

Some DVD players may have different connectors such as DVI-D connector.

Select [DVI/HD] mode from the "DVI MODE" menu when you connect a DVI-D connector. Mode selection, see "DVI MODE" of page 25.

The AUDIO IN 2 and 3 (both RCA) can be used for audio input. For connection, select [AUDIO 2] or [AUDIO 3] from the AUDIO INPUT button.

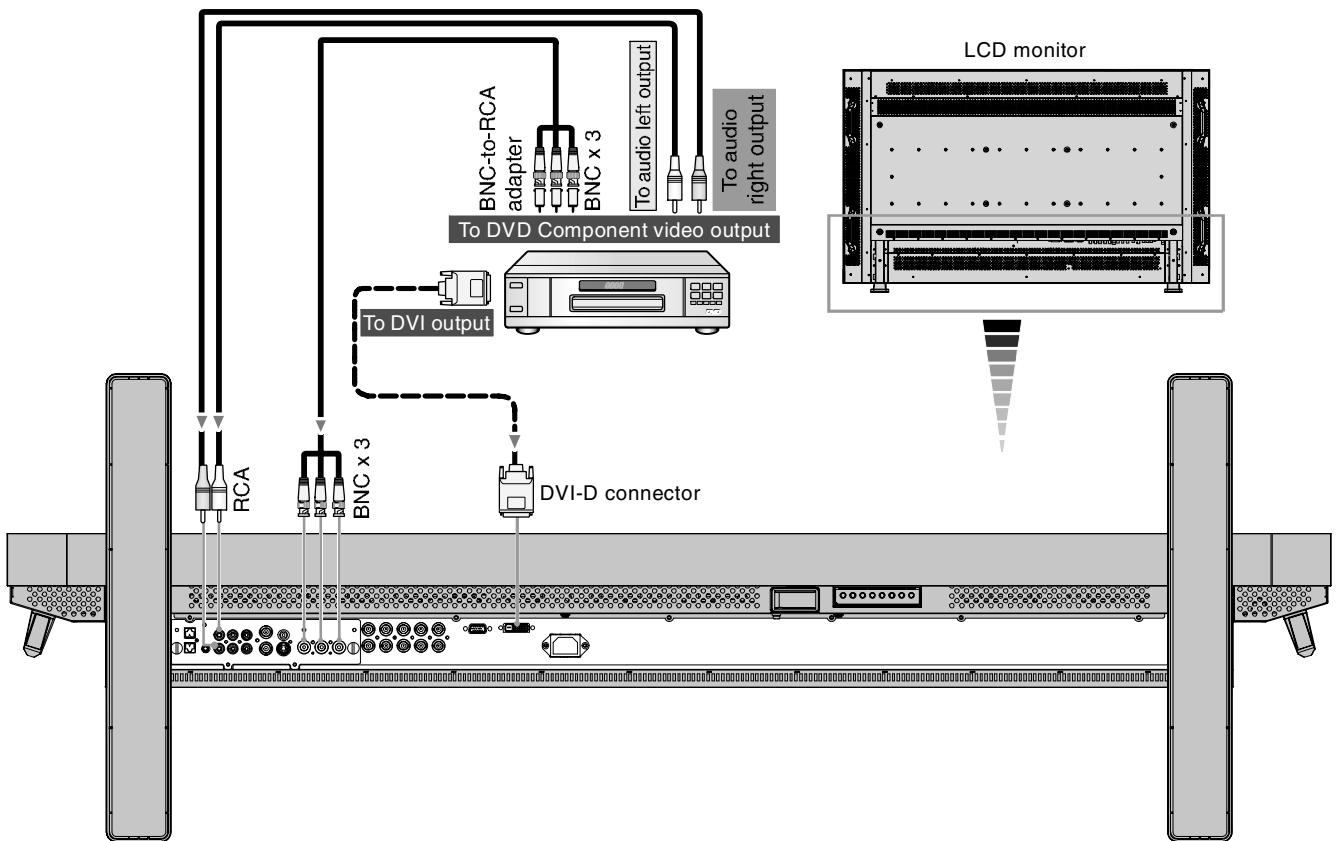

 Denotes an AV unit function.

All AV functions are enabled when the AV unit is installed.

If this product was purchased in Europe the AV unit is preinstalled and all AV functions are available.

Connecting to a Stereo Amplifier

You can connect your stereo amplifier to your LCD monitor. Refer to your amplifier owner's manual for more information.

Connect the LCD Monitor to a Stereo Amplifier

- Turn on the LCD monitor and the amplifier only after all connections have been made.
- Use an RCA cable to connect the AUDIO OUT connector (RCA) on the LCD monitor and the audio input on the amplifier.
- Do not reverse the audio left and right jacks.
- The AUDIO IN is used for audio input.
- The AUDIO OUT jack outputs sound from the selected Audio input.

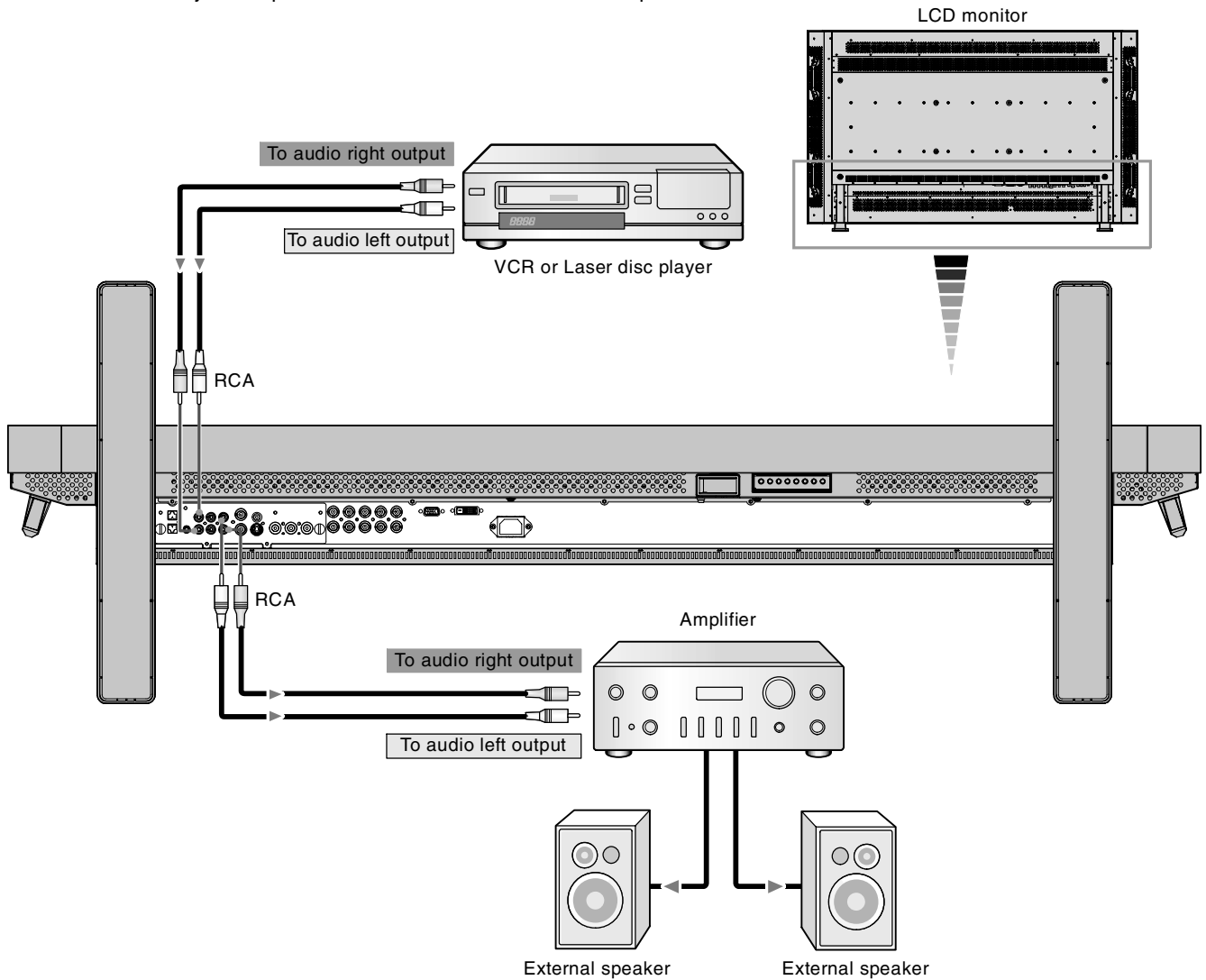

 Denotes an AV unit function.
 All AV functions are enabled when the AV unit is installed.
 If this product was purchased in Europe the AV unit is preinstalled and all AV functions are available.

Basic Operation

Power ON and OFF Modes

The LCD monitor power indicator will turn green while powered on, or red when in off mode. The monitor can be powered on or off using the following three options:

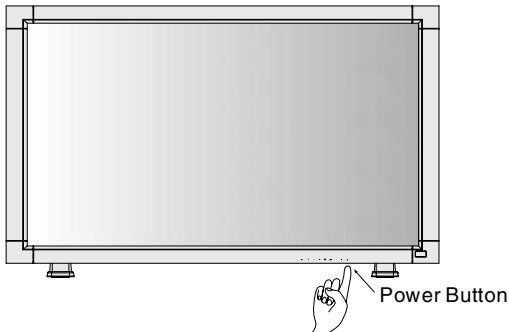

1. Pressing the power button.

Note: Before pressing the power button, be sure to turn on the Main Power Switch on the LCD monitor.

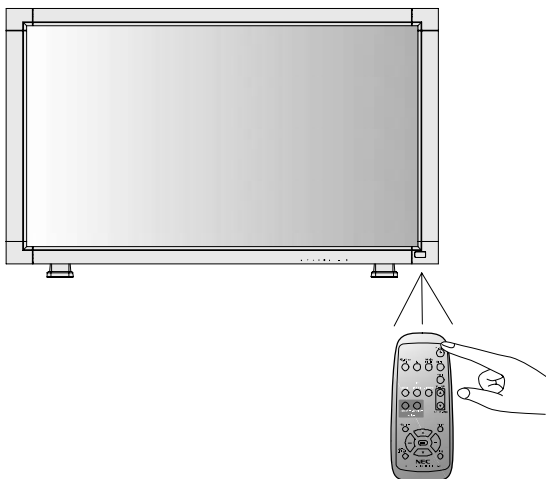

2. Using the remote control.

Note: Before operating the remote control, be sure to turn on the Main Power Switch on the LCD monitor.

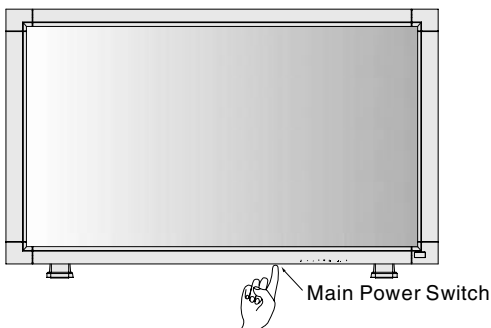

3. Pressing the Main Power Switch.

Note: When the Main Power Switch is used to power off the LCD, the remote control and the power button will not activate the monitor and both green and red power indicators will be off. Be sure to turn the Main Power Switch to the on mode before using these two options.

Power Indicator

	Status
Power ON	Green
Power OFF	Red
Power Standby when "SCHEDULE" is enabled	Red On Green Blinking
Power Standby	Red, Green
Diagnosis (Detecting failure)	Red Blinking * See troubleshooting on page 33

Using Power Management

The LCD monitor follows the VESA approved DPM Power Management function.

The power management function is an energy saving function that automatically reduces the power consumption of the display when the keyboard or the mouse has not been used for a fixed period.

The power management feature on your new display has been set to the "ON" mode. This allows your display to enter a Power Saving Mode when no signal is applied. This could potentially increase the life and decrease the power consumption of the display.

Selecting a video source

To view a video source:

Use the input button to set [VIDEO].

Use the COLOR SYSTEM menu to set [AUTO], [NTSC], [PAL], [SECAM], [PAL60], [4.43NTSC], according to your video format.

Picture Size

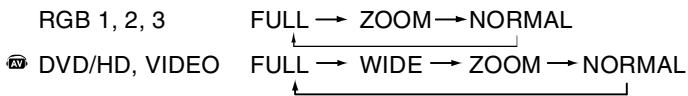

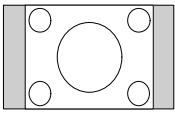
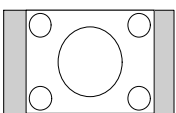
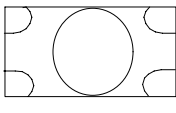
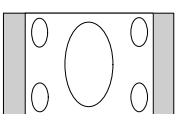
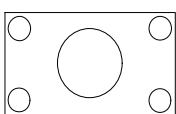
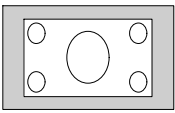
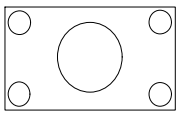
Signal Type	NORMAL SIZE	Recommended Size
4:3		NORMAL 
		ZOOM (DYNAMIC) 
Squeeze		FULL 
Letter box		WIDE 

NORMAL: Displays the signal using the aspect ratio from the PC signal, or displays DVD/HD or VIDEO signal at a 4:3 aspect ratio.

FULL: Displays in entire screen.

WIDE: Expands 16:9 letter box signal to entire screen.

ZOOM (DYNAMIC): Expands 4:3 pictures to the entire screen with non-linearity. (Some around image will be cut by expansion).

ZOOM

Image can be expanded beyond the active display area. The image which is outside of active display area is not shown.

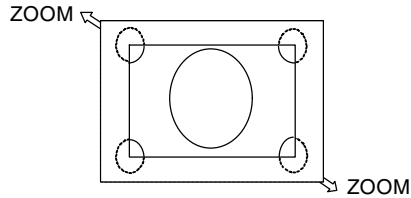

Picture Mode

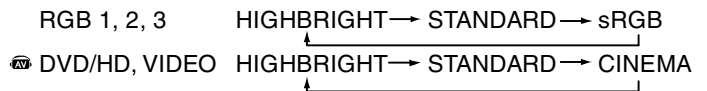

Information OSM

RGB1, 2, 3

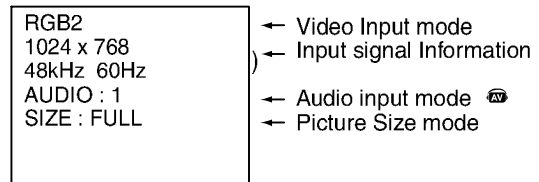

DVD/HD

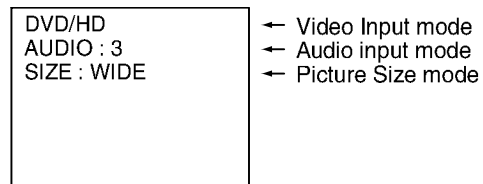

VIDEO

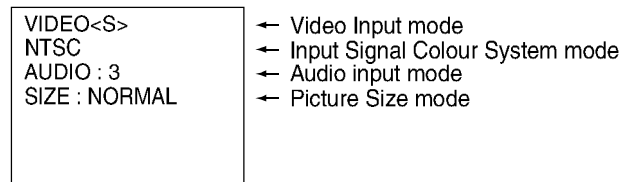

PIP or POP

Main:RGB2
Sub:VIDEO<S>

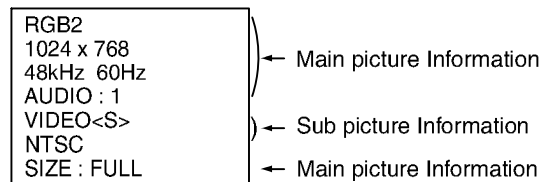

 Denotes an AV unit function.

All AV functions are enabled when the AV unit is installed.

If this product was purchased in Europe the AV unit is preinstalled and all AV functions are available.

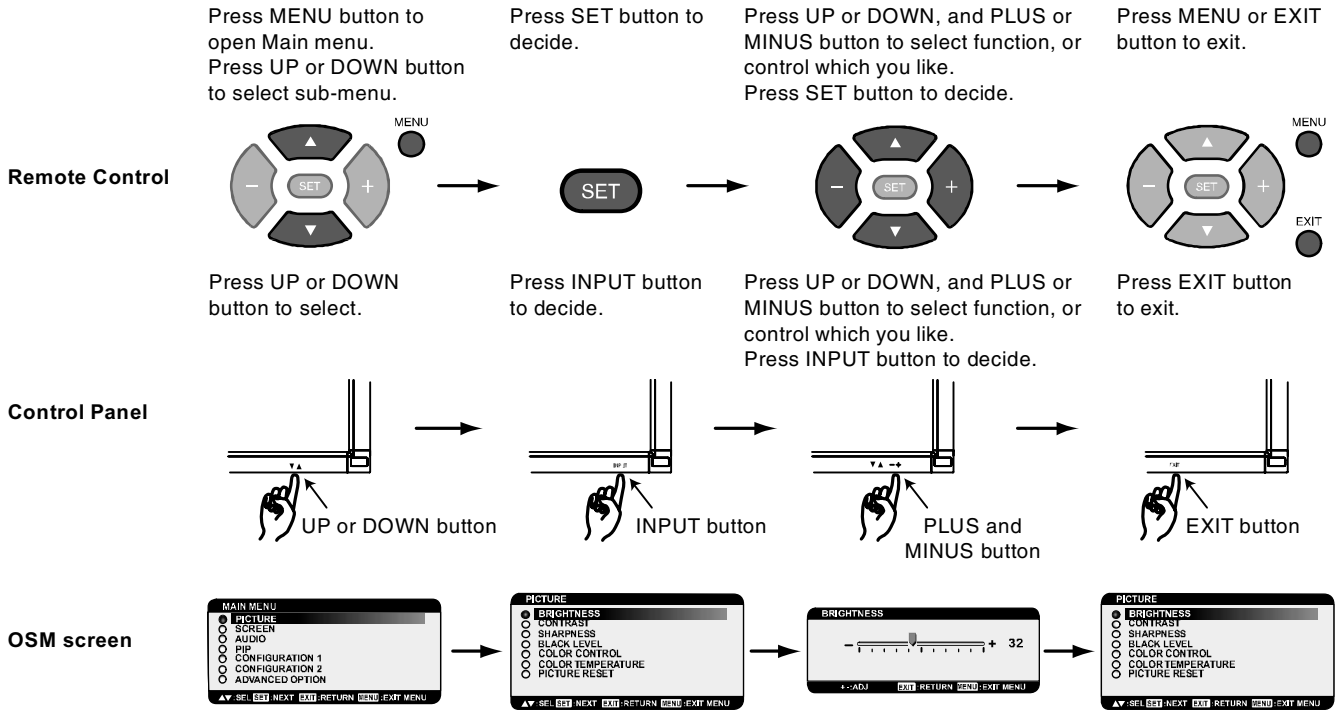

OSM (On-Screen-Manager) Controls







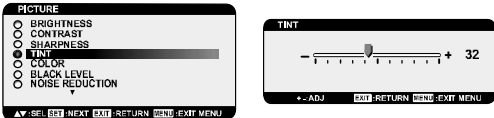
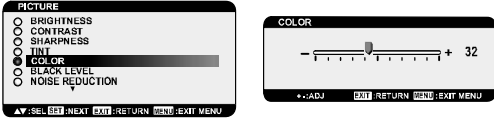

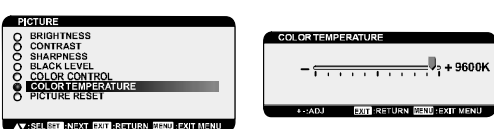
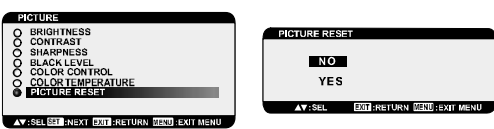

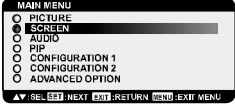
Denotes an AV unit function.
 All AV functions are enabled when the AV unit is installed.
 If this product was purchased in Europe the AV unit is preinstalled and all AV functions are available.

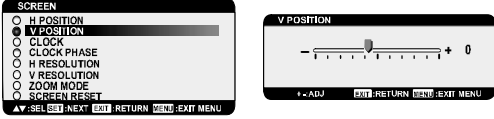
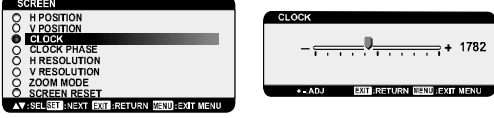
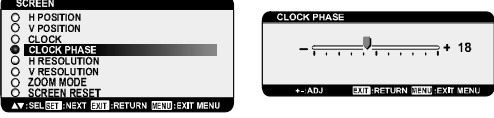
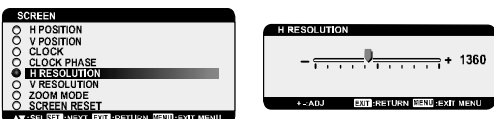

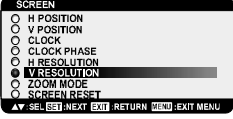
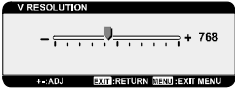
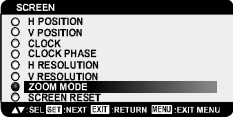

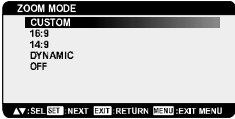
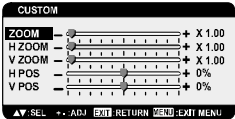

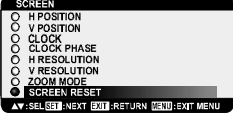

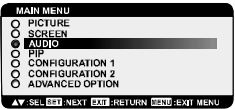

Main-Menu		
PICTURE		
Sub-Menu		
BRIGHTNESS	 	Adjusts the overall image and background screen brightness. Press + button to increase brightness. Press - button to decrease brightness.
CONTRAST	 	Adjusts the image brightness in relation to the input signal. Press + button to increase contrast. Press - button to decrease contrast. NOTE: sRGB picture mode is standard and cannot be changed.
SHARPNESS	 	This function is digitally capable of keeping a crisp image at any timing. It is adjustable to get as distinct an image or as soft an image as you prefer. It is set independently for each picture mode. Press + button to increase sharpness. Press - button to decrease sharpness.
BLACK LEVEL	 	Adjusts the image brightness in relation to the background. Press + button to increase black level. Press - button to decrease black level. NOTE: sRGB picture mode is standard and cannot be changed.
 NOISE REDUCTION	 	Adjusts the noise reduction level. Press + button to increase reduction level. Press - button to decrease reduction level.



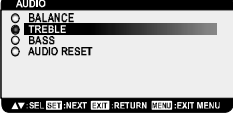
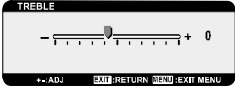

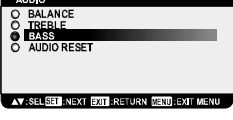
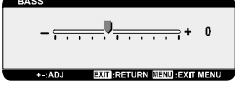

*:INPUT VIDEO only



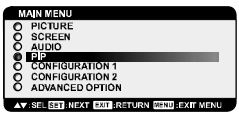

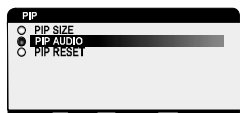

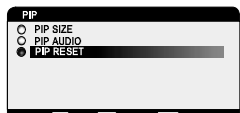
<p>TINT</p> <p>*:INPUT DVD/HD, VIDEO only</p>		<p>Adjust the tint of the screen.</p> <p>Press + button to make flesh tone become greenish. Press - button to make flesh tone becomes purplish.</p>
<p>COLOR</p> <p>*:INPUT DVD/HD, VIDEO only</p>		<p>Adjust the colour depth of the screen.</p> <p>Press + button to increase colour depth. Press - button to decrease colour depth.</p>
<p>COLOR CONTROL</p> <p>*:INPUT RGB1,2,3 only</p>		<p>R, Y, G, C, B, M, S: Increases or decreases Red, Yellow, Green, Cyan, Blue, Magenta and Saturation depending upon which is selected. The change in colour will appear on screen and the direction (increase or decrease) will be shown by the colour bars.</p> <p>NOTE: sRGB picture mode is standard and cannot be changed.</p>
<p>COLOR TEMPERATURE</p>		<p>Adjusts the colour temperature of entire screen.</p> <p>A lower colour temperature makes the screen reddish and a higher colour temperature makes the screen bluish.</p> <p>NOTE: sRGB picture mode is standard and cannot be changed.</p>
<p>PICTURE RESET</p>		<p>Selecting Picture reset allows you to reset all OSM settings within the PICTURE menu.</p> <p>Select "Yes" and press "SET" button to restore to factory preset data.</p> <p>Press "EXIT" button to cancel and then return to the previous menu.</p>

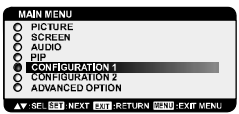
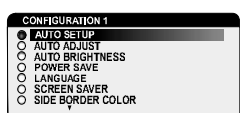

<p>Main-Menu</p> <p>SCREEN</p> <p>Sub-Menu</p> 		
<p>H POSITION</p>		<p>Controls Horizontal Image position within the display area of the LCD.</p> <p>Press + button to move screen to right. Press - button to move screen to left.</p>
<p>V POSITION</p>		<p>Controls Vertical Image position within the display area of the LCD.</p> <p>Press + button to move screen to UP. Press - button to move screen to DOWN.</p>
<p>CLOCK</p> <p>*:INPUT RGB2/3 only</p>		<p>Press + button to expand the width of the image on the screen to the right. Press - button to narrow the width of the image on the screen to the left.</p>
<p>CLOCK PHASE</p> <p>*:INPUT RGB2/3 only</p>		<p>Adjusts image noise (snow).</p>
<p>H RESOLUTION</p> <p>*:INPUT RGB1/2/3 only</p>		<p>Adjusts the horizontal size by increasing or decreasing this setting.</p> <p>Press + button to expand the width of the image on the screen. Press - button to narrow the width of the image on the screen.</p>

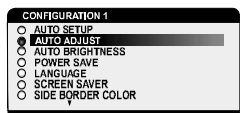

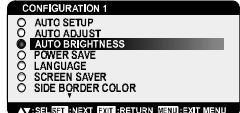

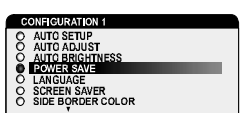
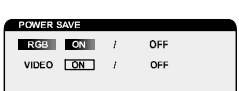
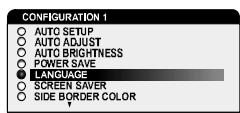
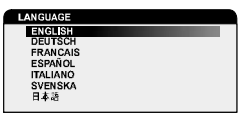
<p>V RESOLUTION</p> <p>*:INPUT RGB1/2/3 only</p>	 	<p>Adjusts the vertical size by increasing or decreasing this setting.</p> <p>Press + button to expand the height of the image on the screen.</p> <p>Press - button to narrow the height of the image on the screen.</p>
<p>ZOOM MODE</p>	  <p>*:INPUT RGB1/2/3 only</p>  <p>*:INPUT DVD/HD, VIDEO only</p> 	<p>Selects the screen zoom mode. This zoom mode will be selected by pushing the "SIZE" button on the remote control.</p> <p>When you select the "CUSTOM", you will be able to adjust optional horizontal and vertical size.</p> <p> You can also select 16:9, 14:9 and DYNAMIC. (INPUT DVD/HD, VIDEO only)</p> <p>Press "SET" button to show a control menu as follows:</p> <p>Increase or decrease "ZOOM" slider to adjust the whole size and then adjust horizontal and vertical size by H ZOOM and V ZOOM. Increase or decrease "H POS" and "V POS" to adjust the picture position.</p> <p> Selecting "DYNAMIC" will expand 4:3 pictures to fill the entire screen with non-linearity. (Some area around the image will be cut off due to expansion.) Dynamic image is the same as FULL size image when HDTV 1080i signal is input.</p> <p>When "OFF" is selected, image will be displayed 1 by 1 pixel. (If you input a signal over 1366x768 resolution, it will be shrunk.)</p>
<p>SCREEN RESET</p>	 	<p>Selecting Screen reset allows you to reset all OSM settings within SCREEN Menu (except H POSITION, V POSITION, CLOCK, CLOCK PHASE, H RESOLUTION, V RESOLUTION).</p> <p>Select "Yes" and press "SET" button to restore the factory preset data.</p> <p>Press "EXIT" button to cancel and then return to the previous menu.</p>

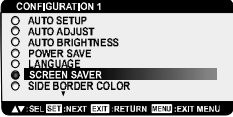
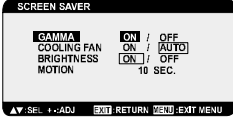
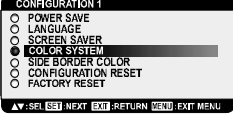
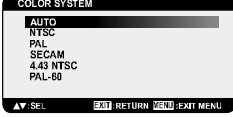
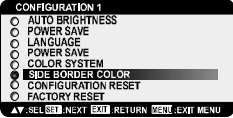
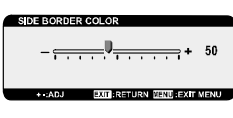
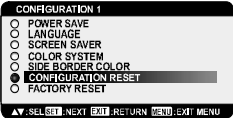
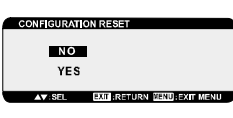
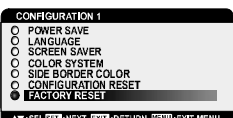

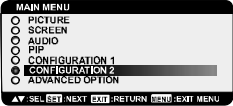
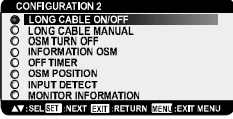
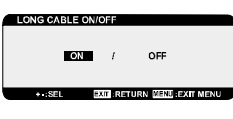

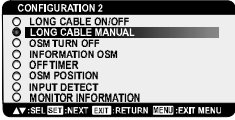
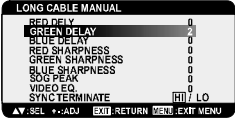
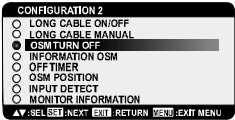
<p>Main-Menu</p> <p>AUDIO</p> <p>Sub-Menu</p>		
<p> BALANCE</p>	 	<p>Adjust the balance of L/R volume.</p> <p>Press + button to move the stereo sound image to right.</p> <p>Press - button to move the stereo sound image to left.</p>
<p> TREBLE</p>	 	<p>To accentuate or reduce the high frequency sound.</p> <p>Press + button to increase TREBLE sound.</p> <p>Press - button to decrease TREBLE sound.</p>
<p> BASS</p>	 	<p>To accentuate or reduce the low frequency sound.</p> <p>Press + button to increase BASS sound.</p> <p>Press - button to decrease BASS sound.</p>
<p> AUDIO RESET</p>	 	<p>Selecting Audio reset allows you to reset all OSM settings within AUDIO Menu.</p> <p>Select "Yes" and press "SET" button to restore the factory preset.</p> <p>Press "EXIT" button to cancel and then return to the previous menu.</p>

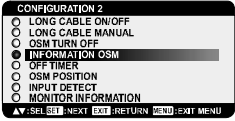
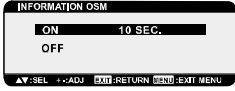
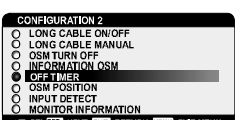
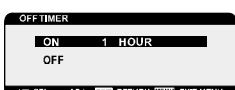
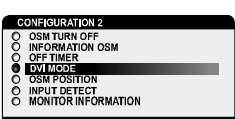

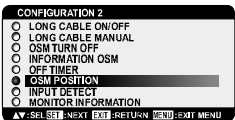
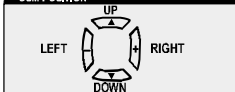

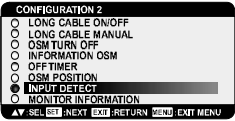

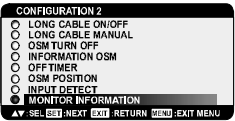
Main-Menu PICTURE IN PICTURE		
Sub-Menu		
PICTURE IN PICTURE SIZE	 	<p>Selecting the size of picture inserted at the "Picture-in-Picture" (PIP) mode.</p> <p>"Large", "Middle" and "Small" are available.</p>
PICTURE IN PICTURE AUDIO	 	<p>Selecting the sound source in PIP mode. When selecting "MAIN AUDIO", you will get the sound for the main picture and when selecting "PIP AUDIO", you will get the sound for the picture instead. When side-by-side mode, MAIN AUDIO is the sound source of the left side screen and PIP AUDIO is the right side.</p>
PICTURE IN PICTURE RESET	 	<p>Selecting PIP Reset allows you to reset all OSM settings within PIP Menu. Select "Yes" and press "SET" button to restore the factory preset data. Press "EXIT" button to cancel and then return to the previous menu.</p>

Main-Menu CONFIGURATION 1		
Sub-Menu		
AUTO SETUP <small>*:INPUT RGB2/3 only</small>	 	<p>Press "SET" button to automatically adjust screen size, horizontal position, vertical position, clock, clock phase, white level and black level. Press "EXIT" button to cancel AUTO SETUP and return to the previous menu.</p>
AUTO ADJUST <small>*:INPUT RGB2/3 only</small>	 	<p>Selecting the auto adjust ON/OFF. When ON, the horizontal position, vertical position and clock-phase will adjust automatically when a change in signal timing is detected.</p>
AUTO BRIGHTNESS <small>*:INPUT RGB1/2/3 only</small>	 	<p>Turns the auto brightness ON/OFF. When "ON" is selected, the brightness will be automatically adjusted.</p>
POWER SAVE	 	<p>When RGB "ON" is selected, the monitor will go to power management mode when RGB1,2,3 sync is lost. When VIDEO "ON" is selected, the monitor will go to power management mode after about 10 minutes delay after the DVD/HD and VIDEO input signal is lost.</p> <p>NOTE: When connecting RGB1, the video card might not stop sending digital data even if image has disappeared. In this case the monitor does not go to power management mode.</p>
LANGUAGE	 	<p>OSM control menus are available in seven languages.</p>

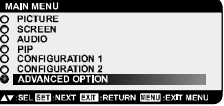
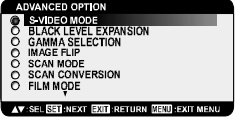

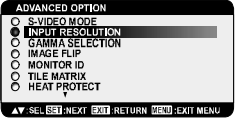
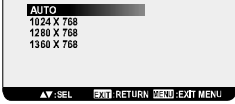
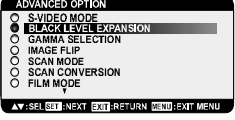

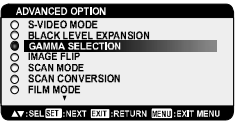
<p>SCREEN SAVER</p>	 	<p>Select "SCREEN SAVER" functions to reduce the risk of the "image persistence".</p> <p>GAMMA: the display gamma is changed and fixed.</p> <p>COOLING FAN: the built in cooling fan is always on.</p> <p>BRIGHTNESS: the brightness is decreased.</p> <p>MOTION: Image is slightly expanded and moves 4 directions (UP, DOWN, RIGHT, LEFT) periodically (Need setting the time for movement).</p> <p>Movement area is approximately +/- 10mm from original position; Please locate the important information such as text within 90% area of screen image.</p> <p>See note (1) for this functions.</p> <p>PIP, POP, Side by Side and STILL will be disabled when "MOTION" is active.</p>
<p>COLOR SYSTEM</p> <p>*:INPUT VIDEO only</p>	 	<p>Selecting the Colour System depends on your input video format.</p> <p>AUTO: NTSC, PAL, SECAM, PAL60 or 4.43 NTSC is automatically selected.</p> <p>NTSC: Specific selection of NTSC.</p> <p>PAL: Specific selection of PAL.</p> <p>SECAM: Specific selection of SECAM.</p> <p>PAL-60: Specific selection of PAL60.</p> <p>4.43NTSC: Specific selection of 4.43 NTSC.</p>
<p>SIDE BORDER COLOR</p>	 	<p>Adjusts the side bar color when a 4:3 image displayed, black to white.</p> <p>Press + button, the bar will become whiter.</p> <p>Press - button, the bar will become darker.</p>
<p>CONFIGURATION RESET</p>	 	<p>Selecting the CONFIGURATION RESET allows you to reset all configuration settings.</p> <p>Select "Yes" and press "SET" button to restore the factory preset data.</p> <p>Press "EXIT" button to cancel and return the previous menu.</p>
<p>FACTORY RESET</p>	 	<p>Selecting "YES" allows you to reset PICTURE, SCREEN, AUDIO, CONFIGURATION1,2 and ADVANCED OPTION back to factory settings (H POSITION, V POSITION, CLOCK, CLOCK PHASE, H RESOLUTION, V RESOLUTION, LANGUAGE, DATE & TIME and SCHEDULE are not reset).</p> <p>Select "YES" and press "SET" button to restore the factory preset data.</p> <p>Press "EXIT" button to cancel and return the previous menu.</p>
<p>Main-Menu</p> <p>CONFIGURATION 2</p> <p>Sub-Menu</p> 		
<p>LONG CABLE ON/OFF</p> <p>*:INPUT RGB2/3 only</p>	 	<p>Automatically adjusts the display to compensate for image degradation caused by using a long cable.</p> <p>Please refer to the CD-ROM included for alteration.</p>

<p>LONG CABLE MANUAL *:INPUT RGB2/3 only</p>	 	<p>To manually compensate for image degradation, which is caused by using a long cable.</p> <p>RED/GREEN/BLUE DELAY To adjust the each phase of RED, GREEN and BLUE signal. LEVEL: 0 - 6</p> <p>RED/GREEN/BLUE SHARPNESS To adjust the each performance degradation of RED, GREEN and BLUE signal. LEVEL: 0 - 45</p> <p>SOG PEAK To adjust the shape of Sync on Green signal. Level: 0 - 1</p> <p>VIDEO EQ (Input RGB 3 only) To optimize the shape (Tailing) of RED, GREEN and BLUE signal. Level: 0 - 7</p> <p>SYNC TERMINATE (Input RGB 3 only) To select the terminate resistance for matching the cable impedance. HI: 2.2K ohm/LO:75 ohm</p>
<p>OSM TURN OFF</p>	 	<p>The OSM control menu will stay on as long as it is use. In the OSM Turn Off submenu, you can select how long the monitor waits after the last touch of a button to shut off the OSM control menu. The preset choices are 10 -240 seconds.</p>
<p>INFORMATION OSM</p>	 	<p>Selects whether the information OSM is displayed or not. The information OSM will display a warning message when an input signal or source changes or if there is no signal detected or the signal is out of frequency range. A time between 3 to 10 seconds is available.</p>
<p>OFF TIMER</p>	 	<p>To turn the OFF TIMER mode ON/OFF. In the OFF TIMER menu, you can preset the monitor to automatically power down. A time between 1 to 24 hours is available. When the OFF TIMER is set, the SCHEDULE (see page 28) settings will be disabled.</p>
<p>DVI MODE *:INPUT RGB1 only</p>	 	<p>Selects the kind of DVI-D equipment which is connected RGB1. Select "DVI-PC" when PC or other computer equipment is connected. Select "DVI-HD" when DVD player, which has DVI-D output, is connected.</p>
<p>OSM POSITION</p>	 	<p>Adjusts the position of the OSM menu. Press + button to move to the right side of the screen. Press - button to move to the left side of the screen. Press ▲ button to move to the top of the screen. Press ▼ button to move to the bottom of the screen.</p>

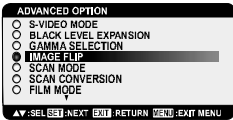
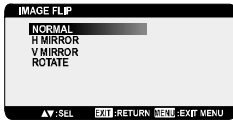
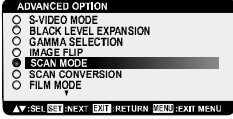
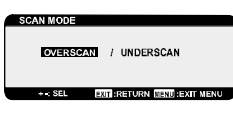
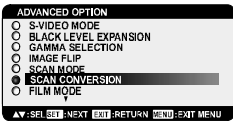
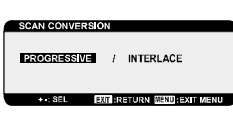
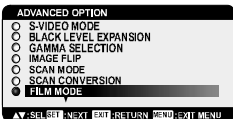
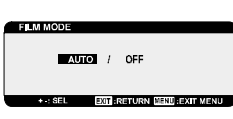
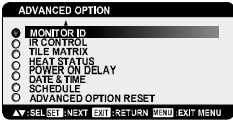
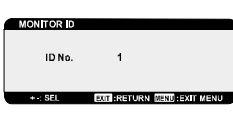
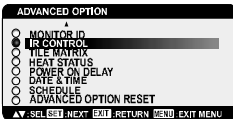
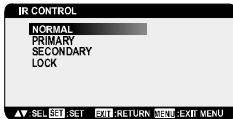
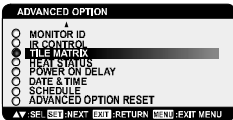
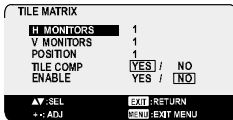
<p>INPUT DETECT</p>	 	<p>Selects the method of input detection when more than two input sources are connected.</p> <p>FIRST DETECT: When the current video input signal is not present, the monitor searches for a video signal from the other video input port. If the video signal is present in the other port, then the monitor switches the video source input port to the new found video source automatically. The monitor will not look for other video signals while the current video source is present. This function is available at input RGB 1/2/3.</p> <p>LAST DETECT: When the monitor is displaying a signal from the current source and a new secondary source is supplied to the monitor, the monitor will automatically switch to the new video source. When current video input signal is not present, the monitor searches for a video signal from the other video input port. If the video signal is present in the other port, then the monitor switches the video source input port to the new found video source automatically.</p> <p>This function is available at input RGB 1/2/3.</p> <p>VIDEO DETECT: DVD/HD or VIDEO inputs will have priority over RGB1/2/3. When DVD/HD or VIDEO input signal is present the monitor will change and keep to the DVD/DH or VIDEO input.</p> <p>NONE: The Monitor will not search the other video input port.</p>
<p>MONITOR INFORMATION</p>	 	<p>Indicates the model and serial number of your monitor.</p>

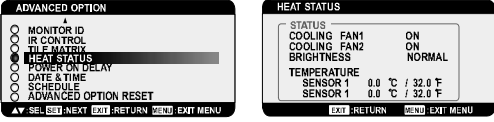
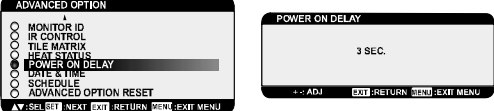
<p>Main-Menu</p> <p>ADVANCED OPTION</p> <p>Sub-Menu</p>		
<p>S-VIDEO MODE</p>	 	<p>Selects the S-Video input port function.</p> <p>PRIORITY: If cable is connected to the S-Video input, it will have priority the composite input port.</p> <p>SEPARATE: S-Video port and Composite port are selectable as independent input port.</p>
<p>INPUT RESOLUTION</p> <p>*:INPUT RGB2/3 only</p>	 	<p>Keeps the input signal at one of the below timings, 1024x768, 1280x768 and 1360x768.</p> <p>AUTO: Determines the resolution automatically.</p> <p>1024x768: Determines the resolution as 1024x768</p> <p>1280x768: Determines the resolution as 1280x768</p> <p>1360x768: Determines the resolution as 1360x768</p>
<p>BLACK LEVEL EXPANSION</p> <p>*:INPUT VIDEO only</p>	 	<p>Selects a level of black expansion.</p> <p>To keep from going under the black cut-off level, please adjust the "Black level" in moderation on OSM menu.</p>
<p>GAMMA SELECTION</p>	 	<p>Selects a display gamma.</p> <p>2.2</p> <p>2.4</p> <p>S gamma</p> <p>Native</p> <p>NOTE: sRGB picture mode is standard and cannot be changed.</p>

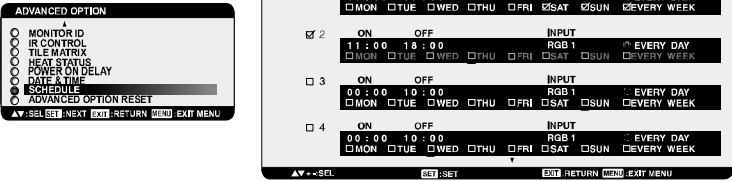
<p>IMAGE FLIP</p>	 	<p>Selects the image flip or rotation. NORMAL: Normal display. H MIRROR: Mirror image for horizontal direction. V MIRROR: Mirror image for vertical direction. ROTATE: Rotate the image 180 degrees.</p>
<p>SCAN MODE *:INPUT DVD/HD, VIDEO only</p>	 	<p>Changes the display area of the image. OVERSCAN: Set to display area about 95% UNDERSCAN: Set to display area about 100%</p>
<p>SCAN CONVERSION</p>	 	<p>Selects IP (Interlace to Progressive) converter function. PROGRESSIVE: Enable the IP function, to convert interlace signal to progressive. This setting is normally used. INTERLACE: Disable the IP function. NOTE: The INTERLACE mode is better suited for motion pictures, but may cause image retention if used on a fixed image.</p>
<p>FILM MODE *:INPUT DVD/HD, VIDEO only</p>	 	<p>Selects Film mode. AUTO: Enable the Film mode function. This mode is better suited for movies, which is converted 24 Frames/sec source to DVD Video. We recommend to select "PROGRESSIVE" in "SCAN CONVERSION" when using this mode. OFF: Disable the Film mode function. This mode is better suited for Broadcasting or VCR source.</p>
<p>MONITOR ID</p>	 	<p>Set the Monitor ID number when multiple MultiSync LCD5710 monitors are daisy-chained together. The Monitor ID can be set to a number between 1 and 26.</p>
<p>IR CONTROL</p>	 	<p>Selects the infrared wireless remote controller mode for use with the RS-232C daisy chain. The item in this menu will become effective by pressing "SET" button on the selected item. NORMAL: The monitor will be controlled normally by wireless remote controller. PRIMARY: Set "PRIMARY" at the head of the daisy chained monitors by RS-232C. SECONDARY: Set "SECONDARY" after 2nd daisy chained monitor. LOCK: Disable the monitor control by infrared wireless remote controller. Keep pressing "DISPLAY" button for 5 sec or more, this setting will return to "NORMAL".</p>
<p>TILE MATRIX</p>	 	<p>The "TILE MATRIX" feature allows one image to be displayed on multiple screens. This feature can be used with up to 25 monitors. (5 horizontal x 5 vertical). Using the Tile Matrix function requires the PC output signal to be sent through a distribution amplifier to each individual monitor. H MONITORS: Selects the number of horizontal displays. V MONITORS: Selects the number of vertical displays. POSITION: Selects a position to expand the screen. TILE COMP: Works in tandem with "TILE MATRIX" to compensate for the width of the tiled bezels in order to accurately display the image. ENABLE: Select "YES", to expand the signal to the selected settings. PIP, POP, SIDE by SIDE, STILL and DYNAMIC zoom mode will be disabled when the "TILE MATRIX" is activated.</p>

<p>HEAT STATUS</p>		<p>Provides information on the status of the COOLING FAN, BRIGHTNESS and TEMPERATURE. COOLING FAN runs when internal temperature of the monitor is over a specified limit. BRIGHTNESS is decreased when internal temperature of the monitor is over specified limit while the cooling fan is in use. In this case, a warning is displayed on the screen.</p>
<p>POWER ON DELAY</p>		<p>Adjusts the delay time between “standby” to “power on” mode. “POWER ON DELAY” time is selectable between 0 and 50 sec.</p>
<p>DATE & TIME</p>		<p>Adjusts the current date and time for internal clock. You should set this function when you use “SCHEDULE”.</p>
<p>SCHEDULE</p>		<p>Programs the monitor’s working schedule. Schedules the power on and power off with hour and day of the week. Also sets the input port. Select “EXIT” to set schedule. (see “NOTE 3” on page 29 for further information).</p>
<p>ADVANCED OPTION RESET</p>		<p>Selecting ADVANCED OPTION reset allows you to reset all OSM settings from ADVANCED OPTION settings, except for DATE & TIME, and SCHEDULE. Select “YES” and press “SET” button to restore the factory preset data. Press “EXIT” button to cancel and then return the previous menu.</p>

NOTE 1: IMAGE PERSISTENCE

Please be aware that LCD Technology may experience a phenomenon known as Image Persistence. Image Persistence occurs when a residual or “ghost” image of a previous image remains visible on the screen. Unlike CRT monitors, LCD monitors’ image persistence is not permanent, but constant images being displayed for a long period of time should be avoided. To alleviate image persistence, turn off the monitor for as long as the previous image was displayed. For example, if an image was on the monitor for one hour and a residual image remains, the monitor should be turned off for one hour to erase the image. As with all personal display devices, NEC DISPLAY SOLUTIONS recommends displaying moving images and using a moving screen saver at regular intervals whenever the screen is idle or turning off the monitor when not in use.

Please set “SCREEN SAVER”, “DATE & TIME” and “SCHEDULE” functions to further reduce the risk of Image persistence.

For long life use of Public Display

< Image Sticking of LCD Panel >

When LCD panel is operated continuously for long hours, a trace amount of electric charge remains near the electrode inside LCD, and a residual or “ghost” image of previous image may be observed. This is called Image Persistence and is not permanent. When a fixed image is displayed for a long period, ionic impurities inside the LCD accumulate along the displayed image. This is called “Image Sticking” and is permanent.

< Recommendations >

For preventing the fast transition to Image Sticking, and for longer life usage of LCD, the following are recommended:

1. Fixed image should not be displayed for long period. Fixed images should be cycled in short intervals.
2. When not in use, do one of the following: turn off the monitor, use the Power Management Function to enter power save mode, or use Schedule Function to turn off the monitor.

3. Reducing the environmental temperature is effective to extend the lifetime of the monitor.

When a Protection cover (glass, acrylic) is installed over the LCD surface and the LCD is enclosed into the box/wall, or monitors are stacked, please utilize the temperature sensors that are inside of the monitor.

To reduce the environmental temperature, the monitor use Low Brightness setting or turn the Cooling Fan "ON" using the Screen saver Function.

4. Please use "Screen Saver Mode" of monitor.

NOTE 2: MONITOR ID and IR CONTROL

Using the one PC or one infra-red wireless controller, you can control up to 26 MultiSync LCD5710 monitors that are daisy-chained together using the RS-232C connection.

1. Connect a PC and MultiSync LCD5710.

Connect a PC's RS-232C control output to the MultiSync LCD5710's RS-232C input.

You can connect multiple MultiSync LCD5710 monitors together. (Refer to page 30).

2. Set Monitor ID.

Set "MONITOR ID" in the "ADVANCED OPTION" menu.

"MONITOR ID" should be set to a unique number on all daisy-chained MultiSync LCD5710 from 1 to 26.

We recommend numbering continuously from 1 in a sequential number.

Set "PRIMARY" to "IR CONTROL" in the "ADVANCED OPTION" menu on the first of the daisy chained monitors.

Set "SECONDERY" to "IR CONTROL" on other monitors.

3. Press "DISPLAY" button aiming at the "PRIMARY" monitor then ID select OSM will be shown at top left side of the screen.

ID: 1 <- ID number of the current monitor.

ID No.: 1 <- ID number of the controllable monitor.

Press "+" button to increase this "ID No.".

Press "-" button to decrease it.

If you control all the daisy-chained monitors at the same time, please select "ALL" as the "ID No."

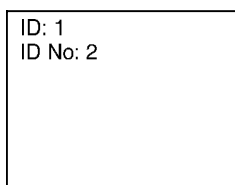

← Monitor ID
← "Monitor ID"
(ID of the monitor
to be controlled)

4. Operate wireless remote controller while aiming at the "PRIMARY" monitor.

The "MENU OSM" will appear on the selected ID No.'s monitor.

NOTE: If "ID No." select OSM is showing at the "PRIMARY" monitor, press "DISPLAY" button to clear this OSM.

HINT: If you lost control due to the wrong "IR CONTROL" setting, keep pressing the "DISPLAY" for more than 5 sec. The monitor will reset "IR CONTROL" to "NORMAL".

NOTE 3: HOW TO SETUP SCHEDULE

Using the "SCHEDULE" function allows you to set up to seven different scheduled time intervals when the LCD Monitor will be activated.

You can select the time the monitor turns on and turns off, the day of week the monitor is activated, and which input source the monitor will use for each scheduled activation period. A check mark in the box next to the number of the schedule indicates that the selected schedule is in effect.

To select which schedule to set, use the up/down arrows to move the red bar vertically under the number (1 to 7) of the schedule.

Use the (+) and (-) buttons to move the red bar horizontally within the particular schedule. The "SET" button is used to make a selection.

If you create a schedule but do not want to use a power on time, select "--" in the "ON" time slot.

If you do not want to use a power off time select "--" in the OFF time slot.

If there is no input selected ("--" showing in the input spot) the input from the previous schedule will be used.

The selection of EVERY DAY within a schedule takes priority over other schedules that are set up to operate weekly.

When schedules are overlapping, scheduled Power ON time has priority over scheduled Power OFF time.

If there are two schedules programmed for the same time, then the highest numbered schedule has priority.

When the "OFF TIMER" (see page 25) is set, the "SCHEDULE" function is disabled.

Controlling the LCD monitor via RS-232C Remote Control

This LCD monitor can be controlled by connecting a personal computer with a RS-232C terminal.

Functions that can be controlled by a personal computer are:

- Power ON or OFF
- Switching between input signals

Connection

LCD Monitor + PC

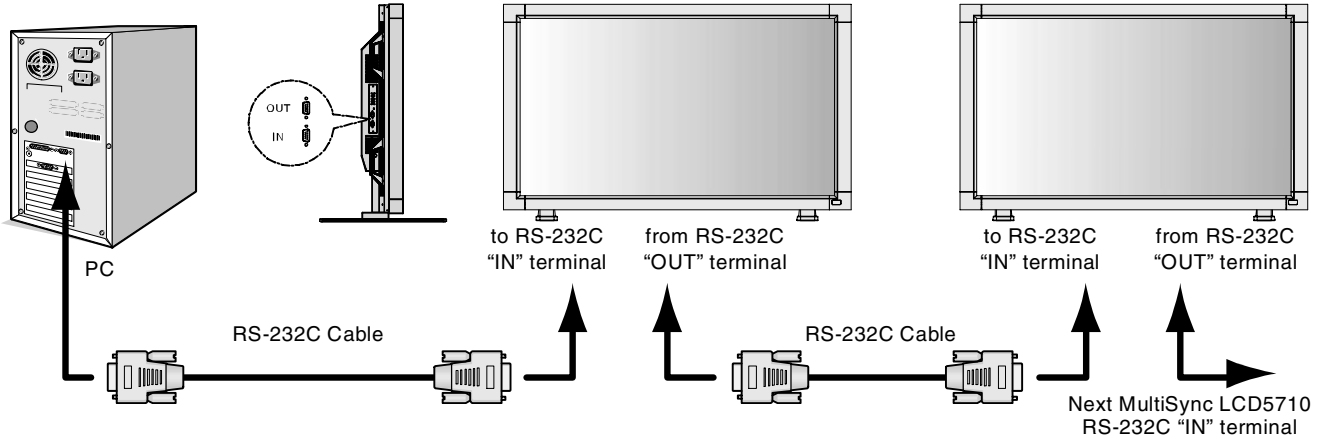

NOTE: If your PC (IBM or IBM compatible) is equipped only with a 25-pin serial port connector, a 25-pin serial port adapter is required. Contact your dealer for details.

* RS-232C OUT terminal can connect MultiSync LCD5710 only. Do not connect other equipment.

The following control sequence is used for a single MultiSync LCD5710. To control multiple MultiSync LCD5710 monitors that are daisy-chained together please use the extended control command. Instructions for the extended control command can be found on the CD included with the display. The file is called "External_control_LCD5X10.pdf". When using the following control commands, all of the daisy-chained monitors can be controlled at the same time from one monitor. Reply and status commands, however, will only pertain to the primary monitor, not secondary monitors.

1) Interface

PROTOCOL	RS-232C
BAUD RATE	9600 [bps]
DATA LENGTH	8 [bits]
PARITY BIT	NONE
STOP BIT	1 [bits]
FLOW CONTROL	NONE

This LCD monitor uses RXD, TXD and GND lines for RS-232C control.

2) Control command diagram

The command is structured by the address code, function code, data code and end code. The length of the command is different for each function.

	Address code	Function code	Data code	End code
HEX	30h 30h	Function	Data	0Dh
ASCII	'0' '0'	Function	Data	↵

- [Address code] 30h 30h (ASCII code, '0' '0'), fixed.
- [Function code] A code of each fixed control move.
- [Data code] A code of each fixed control data (number) and not always indicated.
- [End code] 0Dh (In ASCII code, ↵) fixed.

3) Control sequence

- (1) The command from a computer to the LCD monitor will be sent in 400ms.
- (2) The LCD monitor will send a return command 400ms* after it has received and encoded. If the command isn't received correctly, the LCD monitor will not send the return command.
- (3) The personal computer checks the command and confirms if the command, which has been sent, has been executed or not.
- (4) This LCD monitor sends various codes other than return code. When having a control sequence by RS-232C, reject other codes from personal computers side.

*: The sending time of return command may delay depending on the condition (during changing of the input signal, etc.).

Example: Turn the power ON (' ' is for ASCII code)

Sending commands from the PC	Status code from LCD monitor	Meaning
30 30 21 0D '0' '0' '!' '⏏'		Command for POWER ON
	30 30 21 0D '0' '0' '!' '⏏'	Command received (Command echoed back)

4) Operation commands

The operation commands execute the basic operation setting of this LCD monitor.

It may not operate when changing the signal:

Operation	ASCII	HEX
POWER ON	!	21h
POWER OFF	"	22h
INPUT RGB 1	_r1	5Fh 72h 31h
INPUT RGB 2	_r2	5Fh 72h 32h
INPUT RGB 3	_r3	5Fh 72h 33h
 INPUT VIDEO*1	_v1	5Fh 76h 31h
 INPUT DVD/HD	_v2	5Fh 76h 32h
 INPUT S-VIDEO*2	_v3	5Fh 76h 33h

 Denotes an AV unit function.
All AV functions are enabled when the AV unit is installed.
If this product was purchased in Europe the AV unit is preinstalled and all AV functions are available.

- POWER OFF command should be operated over 1 minute after the power is turned on.
- POWER ON command should be operated over 1 minute after the power is turned off.

*1 S-VIDEO is enabled by having the "S-VIDEO" cable connected with the "S-VIDEO" signal present and selecting "PRIORITY MODE".

*2 S-VIDEO is SEPARATE only.

5) Read command



Host computer sends the command without Data-code to monitor.

After receiving this command, the monitor returns the command with Data-code of current status to host computer.

< ex. > When Host computer ask Power status of monitor, the status of monitor is powered-on.

Command from computer	Command from Monitor	Detail of command
30 30 76 50 0D 0"0"v"P[enter]		Ask about the power status of monitor.
	30 30 76 50 31 0D '0'0"v"P"1"[enter]	Monitor is powered-on.

Structure of the Read-command

		ASCII		HEX	
		Function	Data (Receive)	Function	Data (Receive)
POWER	ON	vP	1	76 50	31
	OFF(stand by)	vP	0	76 50	30
Input	RGB-1(DVI-D)	vl	r1	76 49	72 31
	RGB-2(D-SUB)	vl	r2	76 49	72 32
	RGB-3(BNC)	vl	r3	76 49	72 33
	Video 	vl	v1	76 49	76 31
	DVD/HD 	vl	v2	76 49	76 32
	S-VIDEO 	vl	v3	76 49	76 33
Picture mode	HIGHBRIGHT	vM	p1	76 4D	70 31
	STANDARD	vM	p2	76 4D	70 32
Temperature of Internal monitor	Around AV board	resolution 0.5°C	tcx1	(ex.) +25.0	74 63 78 31 2B 20 32 35 2E 30
		resolution 1°C	tc1	(ex.) +25	74 63 31 2B 20 32 35
	Around Inverter PCB	resolution 0.5°C	tcx2	(ex.) +30.5	74 63 78 32 2B 20 33 30 2E 35
		resolution 1°C	tc2	(ex.) +31	74 63 32 2B 20 33 31

NOTE: For complete information please see file "External_Control_LCD5X10.pdf" on the CD-ROM.

Features

Reduced Footprint: Provides the ideal solution for environments requiring superior image quality but with size and weight limitations.

Colour Control Systems: Allows you to adjust the colours on your screen and customize the colour accuracy of your monitor to a variety of standards.

OmniColor: Combines Six-axis colour control and the sRGB standard. Six-axis colour control permits colour adjustments via six axes (R, G, B, C, M and Y) rather than through the three axes (R, G and B) previously available. The sRGB standard provides the monitor with a uniform colour profile. This assures that the colours displayed on the monitor are exactly the same as on the colour printout (with sRGB supporting operating system and sRGB printer). This allows you to adjust the colours on your screen and customise the colour accuracy of your monitor to a variety of standards.

sRGB Colour Control: A new optimized colour management standard which allows for colour matching on computer displays and other peripherals. The sRGB standard, which is based on a calibrated colour space, allows for optimal colour representation and backward compatibility with other common colour standards.

OSM (On-Screen Manager) Controls: Allow you to quickly and easily adjust all elements of your screen image via simple to use on-screen menus.

Plug and Play: The Microsoft® solution with the Windows® operating system facilitates setup and installation by allowing the monitor to send its capabilities (such as screen size and resolutions supported) directly to your computer, automatically optimizing display performance.

IPM (Intelligent Power Manager) System: Provides innovative power-saving methods that allow the monitor to shift to a lower power consumption level when on but not in use, saving two-thirds of your monitor energy costs, reducing emissions and lowering the air conditioning costs of the workplace.

FullScan Capability: Allows you to use the entire screen area in most resolutions, significantly expanding image size.

VESA Standard (FDMLv1) Mounting Interface: Allows users to connect their LCD monitor to any VESA standard (FDMLv1) third party mounting arm or bracket. Allows for the monitor to be mounted on a wall or an arm using any third party compliant device. NEC recommends using mounting interface that comply with TÜV-GS and/or UL1678 standard in North America.

DVI-D: The digital-only subset of DVI ratified by the Digital Display Working Group (DDWG) for digital connections between computers and displays. As a digital-only connector, analog support is not provided off a DVI-D connector. As a DVI-based digital only connection, only a simple adapter is necessary for compatibility between DVI-D and other DVI-based digital connectors such as DFP and P&D. The DVI interface of this display supports HDCP.

TILE MATRIX, TILE COMP: Demonstrates multiple screens with an accurate image and compensates for the bezel width.

ZOOM: Expands the image individually for horizontal and vertical direction.

RS-232C daisy chain: You can control the multiple monitors by controller or wireless remote controller.

Self-diagnosis: When an internal error should occur, a failure state will be indicated.

CableComp: Automatic long cable compensation prevents image quality degradation (colour shift and dull signals) caused by long cable lengths.

Troubleshooting

No picture

- The signal cable should be completely connected to the display card/computer.
- The display card should be completely seated in its slot.
- Front Power Switch and computer power switch should be in the ON position.
- Check to make sure that a supported mode has been selected on the display card or system being used. (Please consult display card or system manual to change graphics mode.)
- Check the monitor and your display card with respect to compatibility and recommended settings.
- Check the signal cable connector for bent or pushed-in pins.

Power Button does not respond

- Unplug the power cord of the monitor from the AC outlet to turn off and reset the monitor.

Image persistence

- Please be aware that LCD Technology may experience a phenomenon known as Image Persistence. Image Persistence occurs when a residual or “ghost” image of a previous image remains visible on the screen. Unlike CRT monitors, LCD monitors’ image persistence is not permanent, but constant images being displayed for a long period of time should be avoided. To alleviate image persistence, turn off the monitor for as long as the previous image was displayed. For example, if an image was on the monitor for one hour and a residual image remains, the monitor should be turned off for one hour to erase the image.

NOTE: As with all personal display devices, NEC DISPLAY SOLUTIONS recommends displaying moving images and using a moving screen saver at regular intervals whenever the screen is idle or turning off the monitor when not in use.

Image is unstable, unfocused or swimming is apparent

- Signal cable should be completely attached to the computer.
- Use the OSM Image Adjust controls to focus and adjust display by increasing or decreasing the fine adjustment. When the display mode is changed, the OSM Image Adjust settings may need to be re-adjusted.
- Check the monitor and your display card with respect to compatibility and recommended signal timings.
- If your text is garbled, change the video mode to non-interlace and use 60Hz refresh rate.

Image of component signal is greenish

- Check to see if the DVD/HD input connector is selected.

LED on monitor is not lit (no green or red colour can be seen)

- Power Switch should be in the ON position and power cord should be connected.
- Make certain the computer is not in a power-saving mode (touch the keyboard or mouse).

RED LED on monitor is blinking

- A certain failure might have occurred, please contact your nearest authorized NEC DISPLAY SOLUTIONS service facility.

Display image is not sized properly

- Use the OSM Image Adjust controls to increase or decrease the coarse adjustment.
- Check to make sure that a supported mode has been selected on the display card or system being used. (Please consult display card or system manual to change graphics mode.)

Selected resolution is not displayed properly

- Use OSM Display Mode to enter Information menu and confirm that the appropriate resolution has been selected. If not, select corresponding option.

No Sound

- Check to see if speaker cable is properly connected.
- Check to see if mute is activated.
- Check to see if volume is set at minimum.

Remote Control is not available

- Check the Remote Control’s batteries.
- Check if batteries are inserted correctly.
- Check if the Remote Control is pointing at the monitor’s remote sensor.
- The remote control system may not function when direct sunlight or strong illumination strikes the remote control sensor on the LCD monitor, or when there is an object in the path.

“SCHEDULE”/“OFF TIMER” function is not working properly

- The “SCHEDULE” function will be disabled when the “OFF TIMER” is set.
- If the “OFF TIMER” function is enabled and the power to the LCD monitor is turned off or if the power supply is interrupted unexpectedly, then the “OFF TIMER” will be reset.

Either light vertical or horizontal stripes may appear, depending on the specific display pattern. This is no product fault or degradation.

PIP (Picture In Picture) does not work

- Check the resolution of the input signal. PIP does not work with all types of “1080i” input signals. The PIP function will work with 1080p signals.

Specifications

Product Specifications		Analog Input	Digital Input
LCD Module	Pixel Pitch: Resolution: Colour: Brightness: Contrast Ratio: Viewing Angle: Design View Distance:	57" /145.0cm diagonal 0.6518mm 1920 x 1080 dots Over 16 million colours (depending on video card used) 450cd/m ² (Typ.) 1000:1 Up 89°/ Down 89°/ Left 89°/ Right 89° (typ) @ CR>10 1500mm	
Frequency	Horizontal: Vertical:	15.625/15.734kHz, 31.5kHz - 91.1kHz 50.0/58.0 - 85.0 Hz	31.5kHz - 91.1kHz 50.0/58.0 - 85.0 Hz
Pixel Clock		25.0MHz - 165.0MHz	25.0MHz - 165.0MHz
Viewable Size		1251.4 x 703.9mm	
Input Signal			
PC-Input:	Video:	Analog RGB 0.7V p-p Input Impedance 75 ohm Composite sync on Green Video: 0.3Vp-p Neg. (video 0.7Vp-p Pos.) Separate: TTL level (Pos./Neg.) Input Impedance 2.2K ohm (RGB3: 2.2k ohm/75 ohm selectable)	TMD5
VIDEO Input:	Sync: Input-terminal:	BNC (R,G,B,H,V) 15pin Mini D-sub DVI-D (Digital) Composite 1.0V p-p Input Impedance 75 ohm BNC and RCA-INPUT Y/C Y:0.7V p-p C:0.283V p-p Input Impedance 75 ohm S-TERMINAL-INPUT Component 1.0/0.7V p-p Input Impedance 75 ohm BNC-INPUT	
AUDIO Input: RS-232C:	In: Out:	RCA PIN-JACK L/R INPUT, STEREO Mini Jack INPUT 9 Pin D-sub 9 Pin D-sub (with daisy chain)	
Output Signal			
PC-Output: (RGB3 only)	Video: Sync:	Analog RGB Video: 0.7V p-p with 75 ohm terminated Separate HV sync: TTL level (Posi / Nega) with 2.2k ohm terminated	
VIDEO Output:	Output-terminal:	BNC (R,G,B,H,V)	
AUDIO Output:		BNC 1 Output, Composite 1.0V p-p with 75 ohm terminated	
Speaker Output:		RCA PIN-JACK L/R: 1 Output, 0.15Vrms with 1k ohm terminated External Speaker Jack 7W + 7W (8 ohm)	
Resolutions Supported		640 x 480 at 60Hz to 85Hz 800 x 600 at 50Hz, 60Hz to 85Hz 1024 x 768 at 50Hz, 60Hz to 85Hz 1280 x 768 at 50Hz, 60Hz to 85Hz 1360 x 768 at 50Hz, 60Hz to 85Hz 1280 x 1024 at 60Hz to 85Hz 1600 x 1200 at 60Hz 1920 x 1080 at 60Hz*..... Maximum Resolution * Recommended Resolution NTSC/PAL/SECAM/4.43NTSC/PAL60 Component: 480i, 480p, 720p, 1080i	
Power Supply		3.9 - 1.65A @ 100-240VAC, 50/60Hz	
Operational Environment	Temperature: Humidity:	5 - 40°C 20 - 80% (without condensation)	
Storage Environment	Temperature: Humidity:	-20 - 60°C 10 - 90% (without condensation)/ 90% - 3.5% x (Temp - 40°C) regarding over 40°C	
Dimension	Net: Gross:	1357.8 (W) x 792.8 (H) x 164 (D) mm (Without stand) 1357.8 (W) x 825.1 (H) x 480 (D) mm (With stand) 1587 (W) x 965 (H) x 377 (D) mm	
Weight	Net: Gross:	66.0Kg (With stand), 62.0Kg (Without stand) 77.0Kg	
VESA compatible arm mounting interface		3 x 200mm x 200mm (8 Holes) 2 x 200 mm x 200 mm (6 Holes)	
Complied Regulatory and Guidelines		UL60950-1/CSA C22.2 No.60950-1/ TUV-GS/EN60950-1/NOM/IRAM/CCC FCC-B/DOC-B/EN55022/EN55024/EN61000-3-2/EN61000-3-3/CE/GOST-R/PSB/C-tick	
Power Management		VESA DPM	
Plug & Play		VESA DDC2B, DDC/CI	
Accessories		User's manual, Power Cord, Video Signal Cable, Remote Control, AA Battery x 2, Clamp x 3, Screw x 4, CD-ROM, Ferrite Core x 2, Stand x 2, Curled head Screw for stand x 2, Band x 2, Speaker plug x 1set, Main power switch cover	

NOTE: Technical specifications are subject to change without notice.

Mounting on Wall or Ceiling

DO NOT mount the monitor yourself. Please ask dealer.

For proper installation it is strongly recommended you use a trained, qualified technician.

Please inspect the location where the unit is to be mounted. Not all walls or ceilings are capable of supporting the weight of the unit.

Product warranty does not cover damage caused by improper installation, remodeling, or natural disasters. Failure to follow these recommendations could result in voiding the warranty.

To insure safe installation, use two or more brackets to mount the unit to at least two points on the installation location.

Please note the following when mounting on wall or ceiling

- When using mounting accessories other than NEC compliant and approved, they must comply with the VESA-compatible (FDMLv1) mounting method.
- NEC strongly recommends using screws M8 size (15mm + bracket). If using screws longer than 15mm, check the depth of the hole. (Recommended Fasten Force: 1125-1375N•cm)
NEC recommends using mounting interfaces that comply with UL1678 standard in North America.
- Mounting on wall or ceiling is the customer's responsibility.
- Prior to mounting, please inspect the installation location to insure that the location is strong enough to support the mounted unit and that the unit will be safe from harm.
- DO NOT block ventilated openings by mounting accessories or other items too close.
- Refer to the manual included with the mounting equipment for detailed instructions.

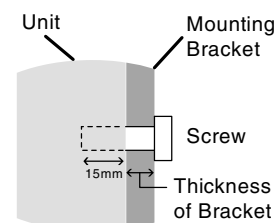

Screw length should equal depth of hole (15mm) + the thickness of mounting bracket.

Orientation

- When using the display in the portrait position, the monitor should be rotated clockwise so that the left side is moved to the top and the LCD indicator light is on the bottom. This will allow for proper ventilation and will extend the lifetime of the monitor. Improper ventilation may shorten the lifetime of the monitor.

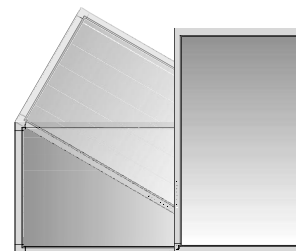

Mounting location

- The ceiling and wall must be strong enough to support the monitor and mounting accessories.
- DO NOT install in locations where a door or gate can hit the unit. Do not install in areas with lots of vibrations and dust. DO NOT install near where the main power supply enters into the building. Doing so may cause fire and the electric shock.
- Do not place where people can easily grab and hang onto the unit or mounting apparatus.
- When mounting in a recessed area, as in a wall, leave at least 4 inches (10cm) of space between the monitor and the wall for ventilation.
- Allow adequate ventilation or air-conditioning around the monitor, so that heat can properly dissipate away from the unit and mounting apparatus.

Mounting on ceiling

- Ensure that the ceiling is constructed strong enough to support the weight of the unit and mounting apparatus over time against earthquakes, unexpected vibration and other external forces.
- Be sure that the unit is mounted to a solid structure within the ceiling such as a support beam. Secure the monitor using the bolt, spring lock washer, washer and nut.
- DO NOT mount to areas that have no supporting internal structure. Do not use wood screws or anchor screws for mounting. DO NOT mount the unit to the baseboard or to hanging fixtures.

Maintenance

- Periodically check for loose screws, gaps, distortions or other abnormalities. If an abnormality is detected please refer to service person.
- Over time, the mounting location may become weaker. Please check regularly.

Pin Assignment

1) Analog RGB input (MiniDsub15p): R G B 2

Pin No	Name
1	Video Signal Red
2	Video Signal Green
3	Video Signal Blue
4	GND
5	DDC-GND
6	Red-GND
7	Green-GND
8	Blue-GND
9	+5V (DDC)
10	SYNC-GND
11	GND
12	DDC-SDA
13	H-SYNC
14	V-SYNC
15	DDC-SCL

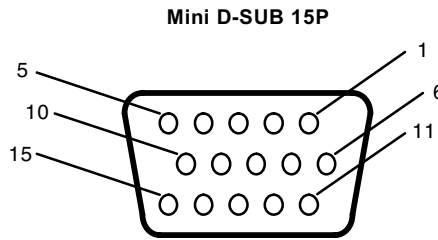

2) S-VIDEO input: V I D E O

Pin No	Name
1	GND
2	GND
3	Y (Luminance)
4	C (Chroma)

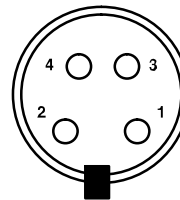

3) Digital RGB input (DVI-D): R G B 1

Pin - Assignment of DVI connector:					
1	TX2-	9	TX1-	17	TX0-
2	TX2+	10	TX1+	18	TX0+
3	Shield (TX2 / TX4)	11	Shield (TX1 / TX3)	19	Shield (TX0 / TX5)
4	NC	12	NC	20	NC
5	NC	13	NC	21	NC
6	DDC-Serial Clock	14	+5V power	22	Shield (TXC)
7	DDC-Serial Data	15	Ground	23	TXC+
8	NC	16	Hot plug detect	24	TXC-

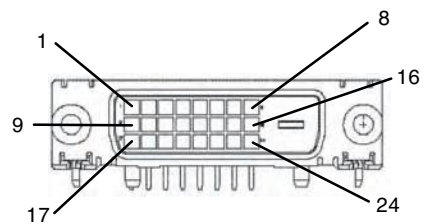

4) RS-232C input/output

Pin No	Name
1	NC
2	RXD
3	TXD
4	NC
5	GND
6	NC
7	RTS
8	CTS
9	NC

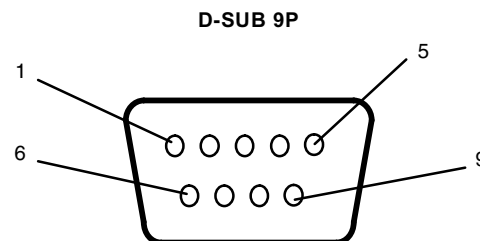

This LCD monitor uses RXD, TXD and GND lines for RS-232C control.