

AKAI

OPERATING INSTRUCTIONS

32" Wide-Screen LCD TV

LCT3226



1. Safety Guidelines

Caution: Always use a power cable is properly grounded. Please use the AC cords listed below for each area:

USA UL
Canada CSA/cUL

FCC Information

This equipment has been tested and found to comply with the limits for a Class B digital device, pursuant to part 15 of the FCC Rules. These limits are designed to provide reasonable protection against harmful interference in a residential installation. This equipment generates, uses, and can radiate radio frequency energy, and if not installed and used in accordance with the instructions, may cause harmful interference will not occur in a particular installation. If this equipment does cause by turning the equipment off and on, the user is encouraged to try to correct the interference by one or more of the following measures:

- Reorient or relocate the receiving antenna.
- Increase the separation between the equipment and receiver.
- Connect the equipment into an outlet on a circuit different from that to which the receiver is connected.
- Consult the dealer or an experienced radio / TV technician for help.

FCC Warning

To assure continued FCC compliance, the user must the provided grounded power supply cord and the provided shielded video interface cables to connect to this equipment. Also, any unauthorized changes or modifications to this equipment would void the user's authority to operate this device.

Important Safeguards

Before using your TV, please read these instructions completely, and keep this manual for future reference.

Carefully observe and comply with all warnings, cautions and instructions placed on the unit or described in the operating instructions or service manual.

The User Manual uses the following symbols to ensure a safe operation and prevent any damage to operators or properties:



WARNING-----Ignorance or inappropriate use may cause damage to the product.



ATTENTION---Ignorance or inappropriate use may cause injury to the user.

Examples:



Prohibition



Warning (Attention) symbol (indicating "Electric Shock").



WARNING

Never place TV on an unstable cart, stand, or table. The TV may fall, causing serious personal injury, death, or serious damage to the TV.



Never overload wall outlets and extension cords.
Never allow anything to rest on or roll over the power cord, and never place the TV where the power cord is subject to wear or abuse.



Keep the product away from moisture:









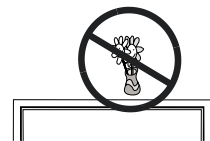

- Do not expose this appliance to rain or moisture.
- If water penetrates into the product, stop the operation; unplug the connector and contact with your dealer. Continuous use in this case may result in fire or electric shock.



WARNING

Never place item such as vases, aquariums, or candles on top of the TV.



<p>Never use a damaged power cord: Heavy objects, heat, or tensile force may damage the power cord and cause fire or electric shock.</p>	
<p>Never block or cover the slots or openings in the TV cabinet back, bottom, and sides. Never place the TV:</p> <ul style="list-style-type: none"> - on a bed, sofa, rug, or similar surface; - too close to drapes, curtains, or walls; or - in a confined space such as bookcase, built-in cabinet, or any other place with poor ventilation. <p>The slots and openings are provided to protect the TV from overheating and to help maintain reliable operation of the TV.</p>	
<p>Do not use the product if any abnormality occurs: If any smoke or odor becomes apparent, unplug the connector and contact the manufacturer immediately. Do not try to repair the product by yourself.</p>	
 WARNING	
<p>Avoid using dropped or damaged appliances: If the product is dropped and the housing is damaged, the internal components may function abnormally. Unplug the connector immediately and contact the manufacturer for repair. Continuous use of the product may cause fire or electric shock.</p>	
 WARNING	
<p>While it is thundering, do not touch the connecting cables or apparatus.</p>	
 ATTENTION	
<p>Do not install the product close to smoke or moisture: Fire or electric shock may be caused when the product is installed close to smoke or moisture. To not install the product in an area with heavy dust or high humidity: Fire or electric shock may be caused when the product is installed in a place with heavy dust or high humidity.</p>	
<p>Instructions for moving the product: Ensure that the power connector and any other leads are unplugged before moving the product.</p>	

OPERATING INSTRUCTIONS

IMPORTANT SAFEGUARDS

The power cable should be kept away from heat sources:
The heat produced by any heat source may melt the covering of the power cable.



Hold the power connector when removing the power cable:
Pulling the power cable itself may damage the wires inside the cable and cause fire or electric shock.

Unplug the connector



Do not touch the connector with wet hands:
To avoid risk of electric shock.



ATTENTION

Insert batteries in accordance with instructions:
Insert the batteries with correct polarities (positive \oplus and negative \ominus).
Incorrect polarities may cause breakage and leakage of the batteries, hurt operators and contaminate the remote controller.



Do not block or cover the vents:
Blocking the vents may cause overheating and fire. Do not install the product in a place with little or no ventilation. Never cover the vents with towels, blankets or dusters.



Unplug the connector:
Unplug the power connector when the product will not be used for a long time.



Unplug the connector

Always make sure the antenna system is properly grounded to provide adequate protection against voltage surges and built-up static charges.(see Section 810 of the National Electric Code.)

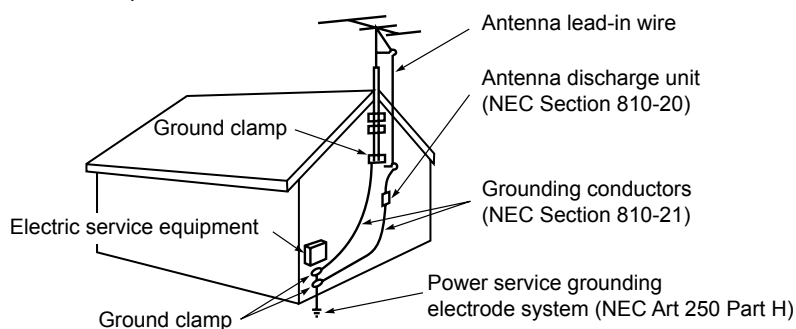

Use extreme care to make sure you are never in a position where your body (or any item you are in contact with, such as a ladder or screwdriver) can accidentally touch overhead power lines. Never locate the antenna near overhead power lines or other electrical circuits. Never attempt to install any of the following during lightning activity:
a). an antenna system; or b).cables, wires, or any home theater component connected to an antenna or phone system.

Others:

- 1). The LCD panel on this TV is manufactured using an extremely high level of precision technology; however, an occasional pixel (dot of light) may display constantly on the screen.
This is a structural property of LCD technology and is not a sign of malfunction.
Such pixels are not visible when the picture is viewed from a normal viewing distance.
- 2). LCD (Liquid Crystal Display) may cause interference in image, sound, etc. of the other electronics that receive electromagnetic waves (i.e. AM radios and video equipment) under certain installed condition. In particular, it may affect electronic equipment beyond the residential until where a LCD TV is used.
- 3). The screen on this TV is manufactured from glass. To prevent damage, never strike the glass with a sharp or heavy object.
- 4). Your LCD television contains a small amount of Mercury. When the television is no longer useful, please follow local electronic waste guidelines for proper disposal.
- 5). If you have the LCD screen facing to the sun, the LCD screen will be damaged. Locate the TV in the place such away from windows side or out side of the rooms with windows.
- 6). This product is designed for indoor use only. The operating temperatures are 5°C ~ 30°C.

OPERATING INSTRUCTIONS

■ IMPORTANT SAFEGUARDS

■ CONTENTS

1. Read these instructions.
2. Keep these instructions.
3. Heed all warnings.
4. Follow all instructions.
5. Do not use this apparatus near water.
6. Clean only with dry cloth.
7. Do not block any ventilation openings. Install in accordance with the manufacturer's instructions.
8. Do not install near any heat sources such as radiators, heat registers, stoves, or other apparatus (including amplifiers) that product heat.
9. Do not defeat the safety purpose of the polarized or grounding-type plug. A polarized plug has two blades wider than the other. A grounding type plug has two blades and a third grounding prong. The wide blade or the third prong are provided for your safety. If the provided plug does not fit into your outlet, consult an electrician for replacement of the obsolete outlet.
10. Protect the power cord from being walked on or pinched particularly at plugs, convenience receptacles, and the point where they exit from the apparatus.
11. Only use attachments/accessories specified by the manufacturer.
12. Use only with the cart, stand, tripod, bracket, or table specified by the manufacturer, or sold with the apparatus. When a cart is used, use caution when moving the cart/ apparatus combination to avoid injury from tip-over.



13. Unplug this apparatus during lightning storms or when unused for long periods of time.
14. Refer all servicing to qualified service personnel. Servicing is required when the apparatus has been damaged in any way, such as power-supply cord or plug is damaged, liquid has been spilled or objects have fallen into the apparatus, the apparatus has been exposed to rain or moisture, does not operate normally, or has been dropped.
15. The apparatus shall not be exposed to dripping or splashing and that no objected filled with liquids, such as vase, shall be placed on the apparatus.

Contents

Important Safeguards	2
1. Before use	8
1.1 Open the Package	8
1.2 Installation	8
2. Product Features	9
3. Accessories	9
4. Names and Functions of Parts	10
4.1 Front View	10
4.2 Rear View	11
4.3 Remote Control	12
5. Connect Accessory Devices	15
6. Basic Operation	18
6.1 Power ON/OFF	18
6.2 Selection of Input Mode	18
6.3 Other Function	19
6.4 Using the POP double-window feature	20
6.5 OSD Option Adjustment	21
6.6 OSD Functions	22
7. Technical Specification	45
8. Support the Signal Mode	46
9. Cleaning and Simple Troubleshooting	47

1. Before use

The product is a 32" XGA (XGA resolution) LCD TV. It has passed the UL and cUL safety certifications, and is an ideal product for personal and commercial use. The product is a precise electronic product. Users should read the following instructions carefully to maximize the performance and life span of the product:

1.1 Open the Package

- The product is packaged in a carton together with other standard accessories. Any optional accessories shall be packed separately in another carton.
- Due to the size & weight of the product, it is recommended that it should be moved by a minimum of two people.
- The protective glass and the glass substrate are installed on the front of the product. Since both glasses can be broken and scraped easily, move the product gently. Never place the unit with the glass facing downwards unless it is protected with soft pads.
- When opening the carton, check that the product is in good condition and that all standard accessories and items are included.
- Whenever possible, use the handles on the back of the Display for transport.

1.2 Installation

- Please use caution if wall mounting this product. Follow all directions from the manufacturer of the wall mount and be sure to securely fasten the product to the mount. While the TV can be wall mounted, improper wall installation may void the warranty.
- Due to the higher power consumption, always use the jack exclusively designed for this product. If an extended line is required, please consult with your service agent.
- The product should be installed on a flat surface to avoid tipping. The distance between the back of the product and the wall should be maintained for proper ventilation.
- Avoid installing the product in the kitchen, bathroom or any other places with higher humidity so as not to shorten the service life of the electronic components.
- Please ensure the product be installed horizontally, any 90 degree clockwise or counterclockwise installation may induce poor ventilation and subsequent component damage.
- To protect the screen and avoid screen burn, do not hold on a static picture for a long time.

2. Product Features

The 32" LCD TV provides quality image displays and is suitable for a variety of multi media applications:

1. Available input signals
 - The standard PC module provides VGA (D-SUB 15 PIN), and DVI (with HDCP) input connectors.
The product supports PC mode image resolutions up to (1280 x 1024@60Hz) with a vertical frequency of 60 Hz.
 - The Video module provides composite video (RCA), S-video (DIN 4 PIN) and component video (RCA) input connectors. It supports the quality input images of DVD and HDTV (480P/720P/1080i). The Video module also provides one set of Stereo Audio output.
 - The TUNER Module
The RF input terminal is for ANTENNA and CABLE TV channels.
2. Power Management Function
The machine provides an automatic power control function.
3. XGA LCD TV Panel
The XGA LCD TV panel provides high resolution and high contrast image. The number of pixels is 1366 (H) x 768 (V). The contrast is 1000:1.
4. Others
 - PIP/POP Function: The user may watch image from two source at same time.
 - The LCD TV unit provides warm, middle and cool color temperature options. The user may customize their favorite color temperature.

3. Accessories

- 1 User Manual x 1
- 2 Stand x 1
- 3 AC Cable x 1
- 4 Remote Control x 1
- 5 Battery(UM-4/R03/AAA) x 2
- 6 Warranty Card x 1
- 7 Insertion Card x 1

4. Names and Functions of Parts

4.1 Front View

Sketch map

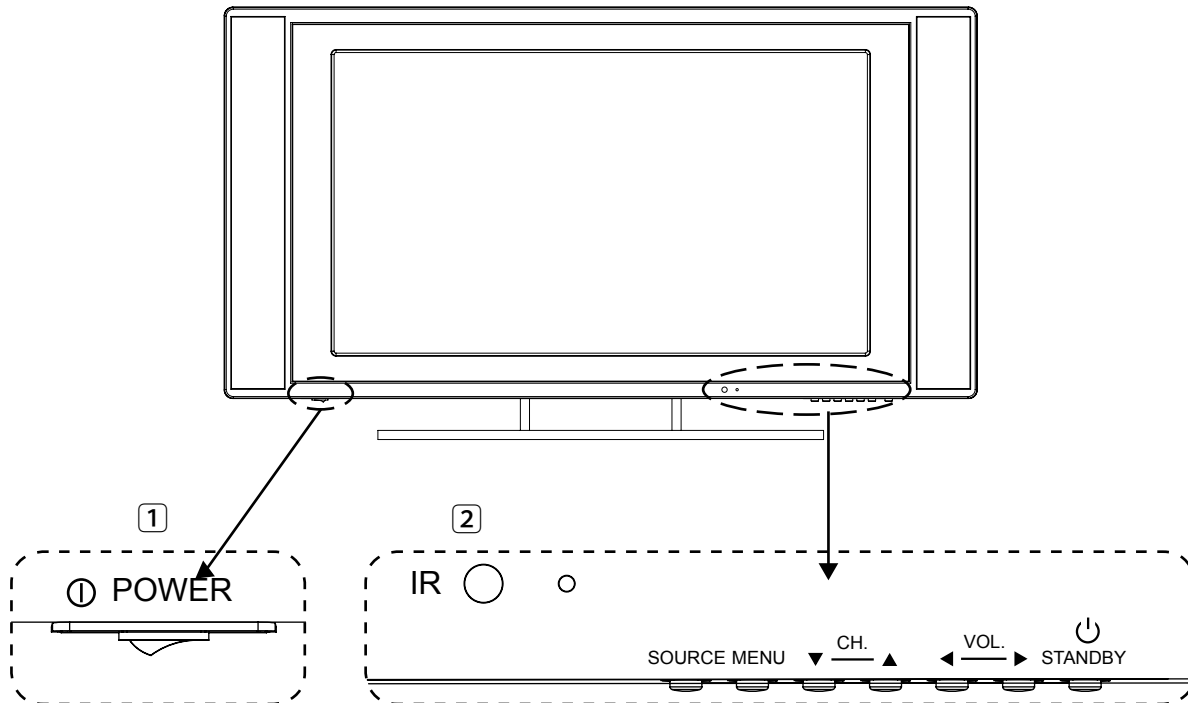

- ① Push the power switch (O: Off, I: On).
- ② (IR) Infrared Receiver: Receives IR signals from the remote control.
 (Power on / Standby) LED: Press \cup (Power) to turn on and off.
 Indicator on (Red) Standby mode
 Indicator on (Green) Power on mode

The functions of the buttons are described as follows:

STANDBY: Press \cup (Standby) to turn on and turn off.

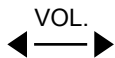

- A. They are used as $\blacktriangleleft / \blacktriangleright$ buttons in the OSD Menu screen.
- B. Press to adjust the volume.

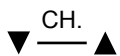

- A. They are used as $\blacktriangleup / \blacktriangledown$ buttons in the OSD Menu screen.
- B. Press to scan through channels. To scan quickly through channels, press and hold down either channels.

MENU: Press to display the menu. Press again to exit the menu.

SOURCE: Press to cycle display TV, AV, S-Video, Component 1, Component 2, DVI and VGA source menu. When display the OSD-menu, press it to confirm.

4.2 Rear View

Sketch map

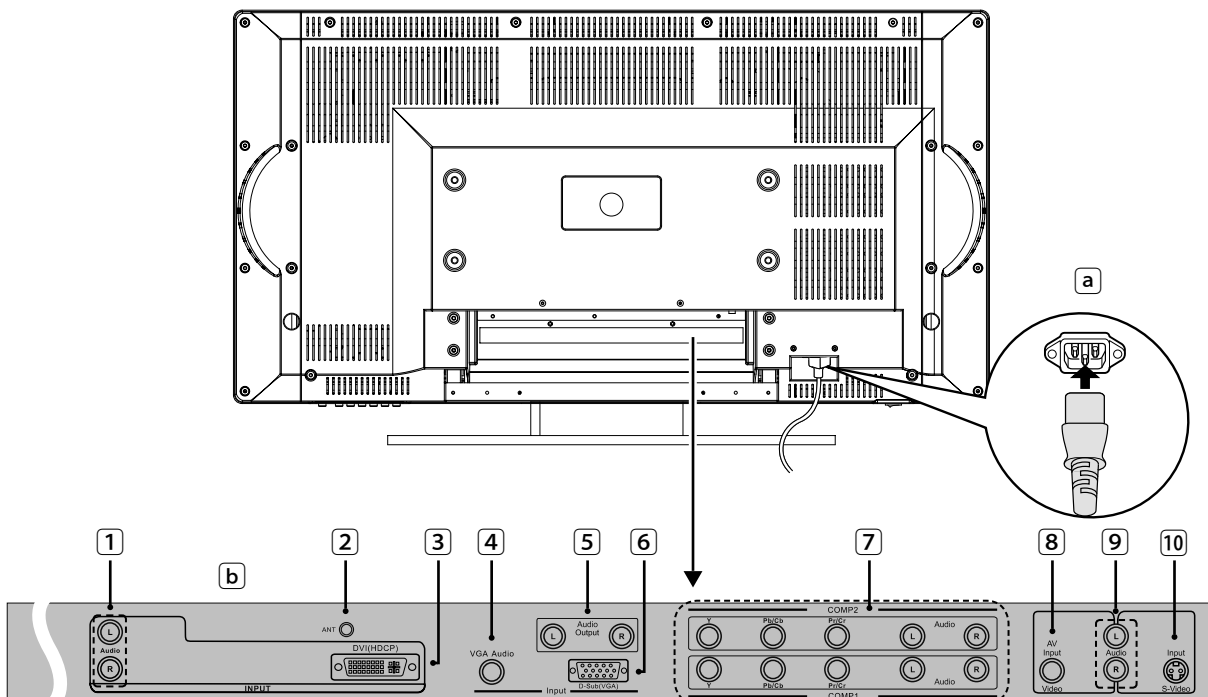



a Use the included power cord and connect to an earthed 100-240V, 50/60Hz AC outlet.

b Signal input and other terminals:

1. **DVI(HDCP) Audio INPUT:** Connect to the audio **L** and **R** output jacks of a device with DVI Audio output.
2. **ANT In:** Connect antenna or cable 75 Ohm coaxial Aerial to receive TV/CABLE signal.
3. **DVI(HDCP) INPUT:** Connect to the digital video output jack of a device with DVI output.
4. **VGA Audio INPUT:** Connect the audio terminal to the audio output terminal of the PC.
5. **AUDIO OUTPUT:** Connect audio amplifier or other TV set that with audio input.
6. **D-SUB(VGA) INPUT:** For PC display purpose. Connects to the Mini D-Sub 15 pins analog output connector of the PC display card.
7. **COMPONENT1, COMPONENT2 YPbPr/YCbCr INPUT:** Connect the separate component video cables to the device having component video outputs (YPbPr/YCbCr) to the **Y**, **Pb/Cb**, and **Pr/Cr** jacks of the TV.
COMPONENT1, COMPONENT2 YPbPr/YCbCr AUDIO INPUT: Connect the audio cable to device's audio **L** and **R** jacks and to the **L** and **R** audio jacks of the TV.
8. **VIDEO INPUT:** Video and Audio inputs for external devices, such as a camcorder or VCR.
9. **AUDIO INPUT:** With AV and S-Video inputs share this terminal.
10. **S-VIDEO INPUT:** Video inputs for external devices with an S-Video output.

4.3 Remote Control

- 1 **Power** (): Press to turn on and off.
- 2 **Mute** (): Press to mute the sound. Press again or press **VOL+ / VOL-** to restore the sound.
- 3 **0~9 Number Buttons**: Press 0~9 to select a channel; the channel changes after 2 seconds.
- 4 **PIP POS**: Press to change the PIP window position under PIP mode.
- 5 **SOURCE**: Press to select the signal source, such as TV, AV, S-Video, Component 1, Component 2, DVI or VGA.
- 6 **SLEEP**: Press repeatedly until it displays the time in minutes (5 Min, 10 Min, 15 Min, 30 Min, 60 Min, 90 Min, 120 Min and, OFF) that you want the TV to remain on before shutting off. To cancel sleep time, press SLEEP repeatedly until sleep OFF appears.
- 7 **PIP**: Press to cycles through the different POP or PIP modes, such as Basic PIP, LR POP, and exit.
- 8 **VOL +/-**: Press to adjust the volume.
- 9 **CH +/-**: Press to scan through channels. To scan quickly through channels, press and hold down either channels.
- 10 **MTS**: Press repeatedly to cycle through the Multi-channel TV sound (MTS) options: Mono, Stereo and SAP (Second Audio Program).
- 11 **◀, ▲, ▼, ▶, ENTER**: Press **◀, ▲, ▼, ▶** to move the on-screen cursor. To select an item, press ENTER to confirm.
- 12 **SYSTEM**: Press repeatedly to cycle through the system options: AUTO and NTSC3.58. (This button is active for AV, S-Video input source.)
- 13 **MENU**: Press to enter into the on-screen setup menu, press again to exit.
- 14 **V-CHIP**: Press to select the child protect mode.
- 15 **CCD**: Press to select the Closed Caption mode.
- 16 **FREEZE**: Press to freeze the picture, press again to restore the picture.
- 17 **DISPLAY**: Press to display the channel information and it disappear after 3 seconds.
- 18 **FAVORITE**: Press repeatedly to cycle through the favorite channel list.

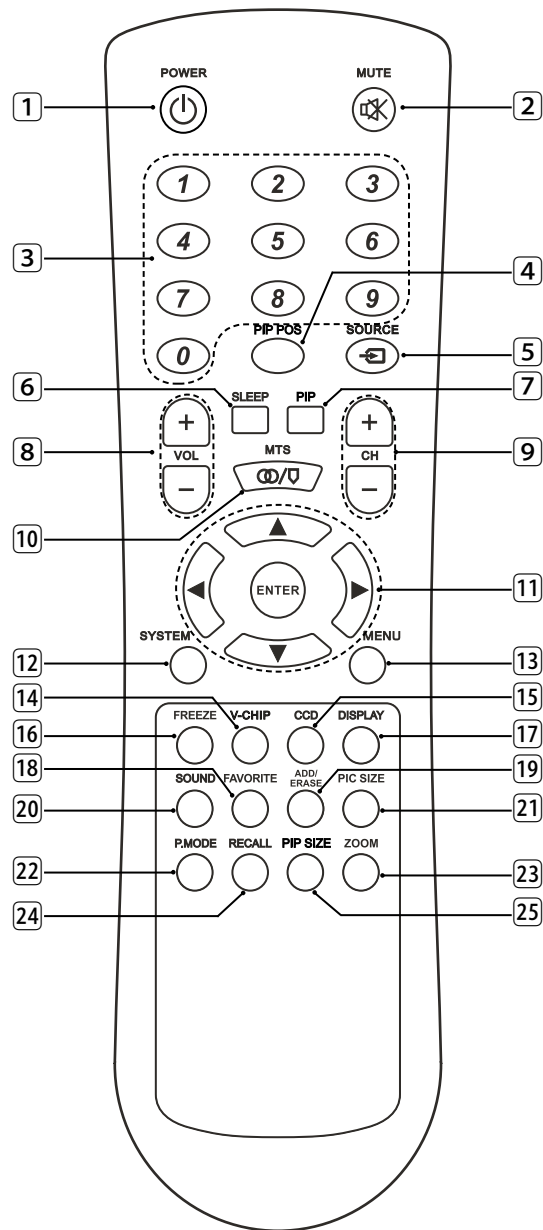

(Continued on next page)

- 19 **Add/Erase:** Press to add or delete favorite channel.
- 20 **SOUND:** Press repeatedly to cycle through the sound mode: Normal, News, Cinema, Flat and User.
- 21 **PIC SIZE:** Press repeatedly to cycle through the picture size that best corresponds your viewing requirements: Normal, Full, Wide1, Wide2, Wide3, 4:3, No scale, and Panoramic .
When in POP mode available picture sizes are: Full, 4:3 and Normal.
- 22 **P.MODE:** Press repeatedly to cycle through the picture mode: Hi-Bright, User, Dark, Normal and Vivid.
- 23 **ZOOM:** Press to zoom the image.
- 24 **RECALL:** Press it return to previous channel.
- 25 **PIP SIZE:** Press to cycle through the PIP size, such as Large, Medium, Small.

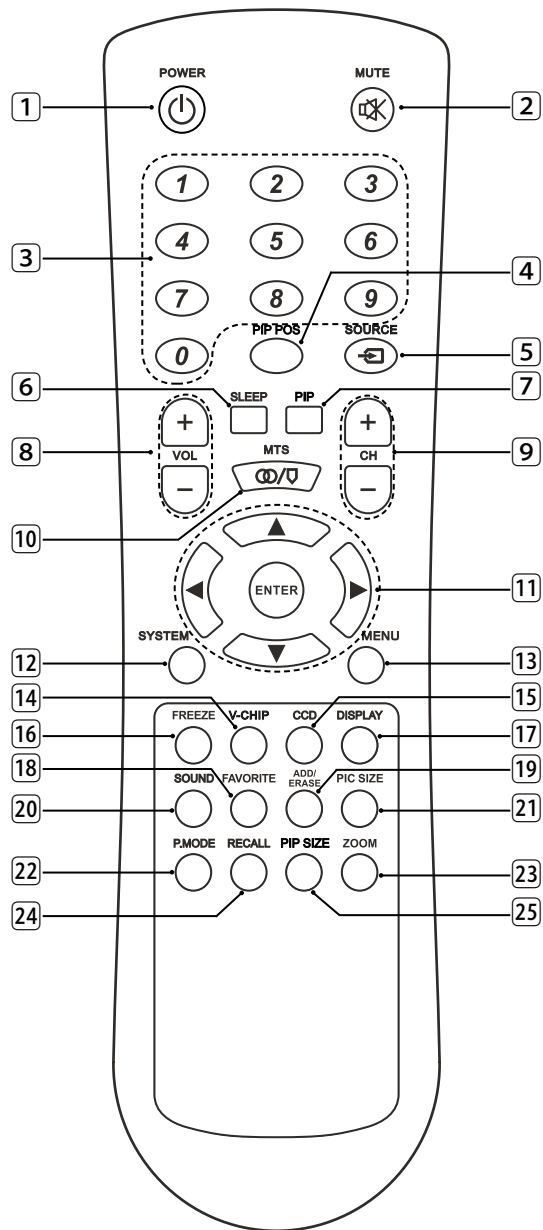

Insertion of Batteries:

- Turn the remote control upside down, press and slide off the battery cover.
- Insert two 1.5V (AAA) batteries into the compartment, take care to observe the ⊕ and ⊖ markings indicated inside.
- Replace the cover and slide in reverse until the lock snaps.

Range of Remote Control

Sketch map

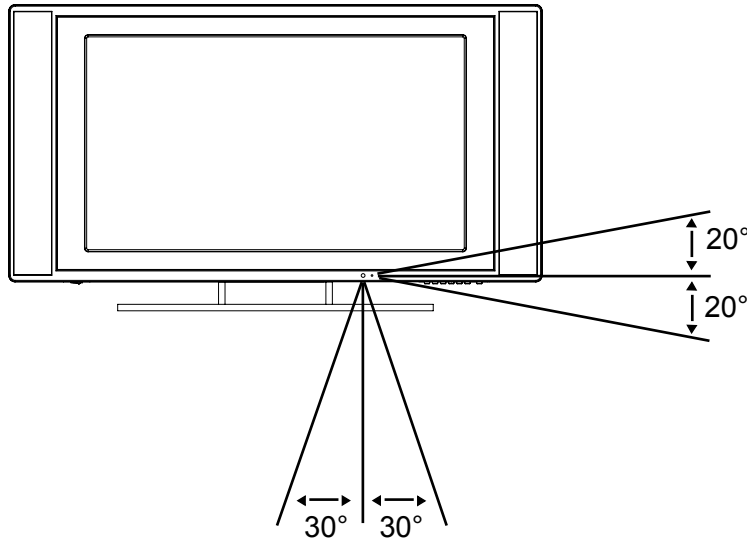

- Ensure the remote control is pointed towards the remote control window on the display unit.
- No obstacles should be placed between the remote control and the remote control window.
- The effective receiving range for the signal is within 5-8 meters from the front of the remote control window, and 30° to the left or right side and 20° above or below the control window.

Care For Remote Control

- Avoid spilling liquids on the remote.
- Avoid dropping or otherwise jarring the remote.
- Always store the remote control at dry and normal room temperature place.
- If the remote is not performing satisfactorily, replace the batteries. The batteries should be replaced after one year.
- If the remote control will be idled for a long time (above 1 month) take out the batteries to avoid leakage from the batteries.
- Clean up the entire remote control especially the battery compartment if any leakage found.
- Do not mix using different kind of new and used batteries together to avoid leakage.

5. Connect Accessory Devices

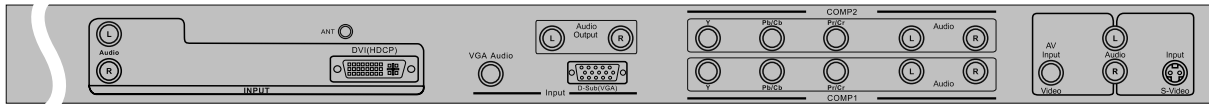

Connecting a DVD player or other equipment

Switch off TV and external equipment before connecting cables.

1. Connect a DVD player or other equipment's Component Video Out (Y,Cb,Cr / Y,Pb,Pr) to the TV's corresponding Component In (Y,Cb,Cr / Y,Pb,Pr) jacks on COMP1 or COMP2.
2. Connect a DVD player's Audio Out to the TV Component L/R jacks.
3. Press POWER to turn on the TV. Turn on external equipment also.
4. Press SOURCE to select COMPONENT 1 or COMPONENT 2 signal source.

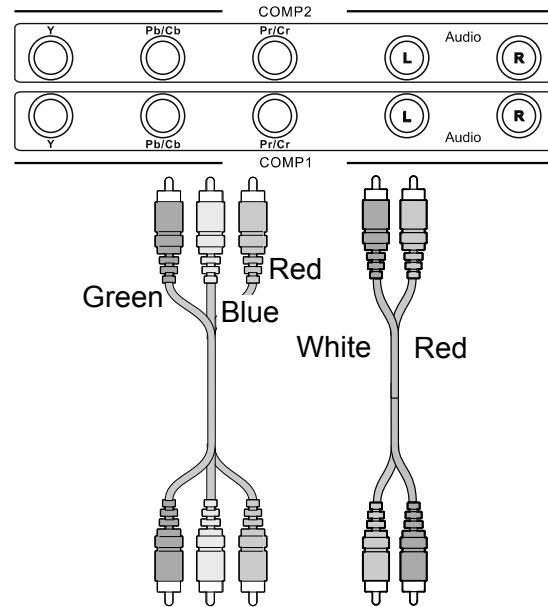

DVD or Set-top box

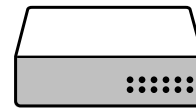

Connecting the Computer

Switch off TV and external equipment before connecting cables.

1. Connect a computer's VGA Out to the TV's D-Sub(VGA) In jacks.
2. Connect a computer's Audio Out to the TV's Audio In jack.
3. Press POWER to turn on the TV. Turn on external equipment also.
4. Press SOURCE to select VGA signal source.

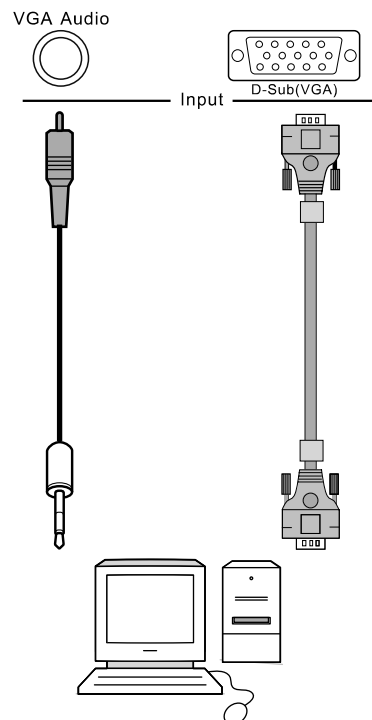

Connecting the DVD or VCR player devices

Switch off TV and external equipment before connecting cables.

1. Connect a DVD or VCR player's Video Out to the TV's Video In jack by a Video cable.
2. Connect a DVD or VCR player's S-VIDEO Out to the TV's S-VIDEO In jack by a S-VIDEO cable.
3. Connect a DVD or VCR player's Audio Out to the TV's L/R jacks by a Audio cable, in this stage, the S-VIDEO and VIDEO is sharing this L/R Audio in channels.
4. Press POWER to turn on the TV. Turn on external equipment also.
5. Press SOURCE to select AV or S-VIDEO signal source.

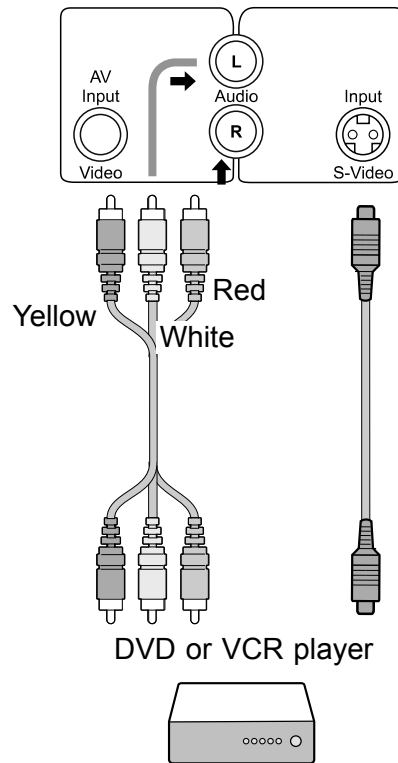

Connecting a device to the DVI(HDCP)

Switch off TV and external equipment before connecting cables.

1. Connect a DVD play or other equipment's DVI Out to the TV's DVI(HDCP) In jacks.
2. Connect a DVD player's Audio Out to the TV Component L/R jacks.
3. Press POWER to turn on the TV. Turn on external equipment also.
4. Press INPUT to select DVI signal source.

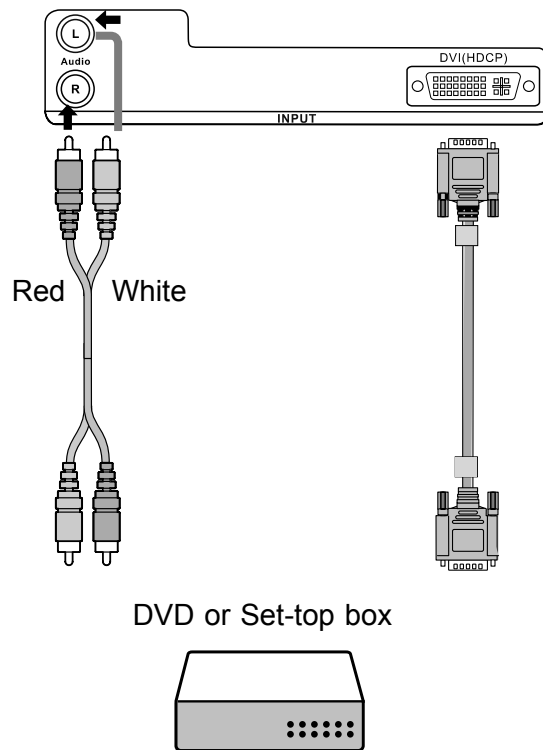

Connecting AUDIO OUTPUT jacks to a stereo amplifier

Switch off TV and external equipment before connecting cables.

1. Connect the TV Audio Output (R/L) to the stereo amplifier In (R/L).
2. Press POWER to turn on the TV. Turn on external equipment also.

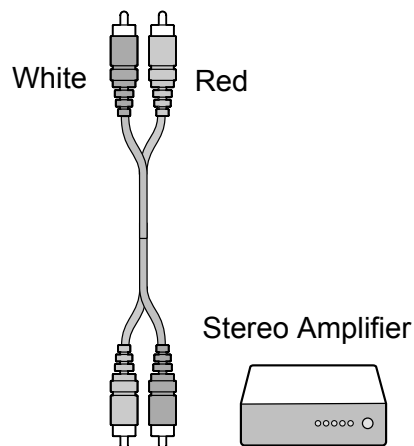
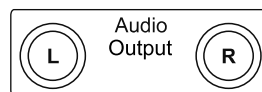

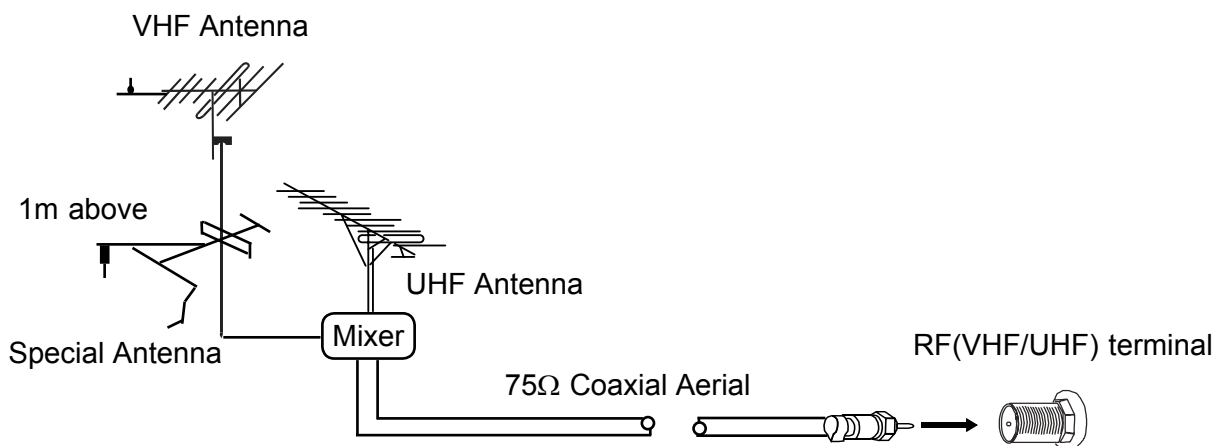

Connecting directly to cable or an antenna

When using 75Ω coaxial Aerial: Connect directly to the RF terminal of the tuner.



6. Basic Operation

6.1 Power ON/OFF: The Display is in Standby mode

- Press the **POWER**  on the remote control or **Standby** on the control panel to turn on the unit. The power indicator changes from red to green.
- Press the **POWER**  on the remote control or **Standby** on the control panel again to return the display to standby mode. The power indicator changes from green to red.

Note: (1) Press **CH +/-** on the remote control can turn on TV set from last preview mode.
 (2) For protecting your LCD TV product, the interval time between turn on the LCD TV product and shut down it should be kept at least one minute.

6.2 Selection of Input Mode

- Press **SOURCE** /  on the remote control or on the LCD TV control panel to select the signal source you desired.

When no input from the selected signal source, "Main no signal" will appear, press **SOURCE** /  on the remote control or on the control panel again to search the next source.



Note: The LCD-TV will automatically turn itself off after approximately 15 minutes if no signal input. When no signal is input for about 14 minutes. A "No signal and going to power down" wording will appear. You can press "◀" or "▶" button to selected, press "**ENTER**" to confirm. If select "Cancel" or no operation, the LCD-TV will automatically turn off after 1 minutes, if select "OK", it will turn off immediately.

6.3 Other Function

FAVORITE:

- Press FAVORITE button repeatedly, you will cycle through Favorite Channel.

ADD/ERASE:

- Press this button to add/erase current channel to/from the list of favorite directly.
- ① Add current channel into the list of favorite if a heart shape mark  displaying on the left top of screen.
 - ② Erase current channel from the list of favorite if a broken heart shape mark  displaying.

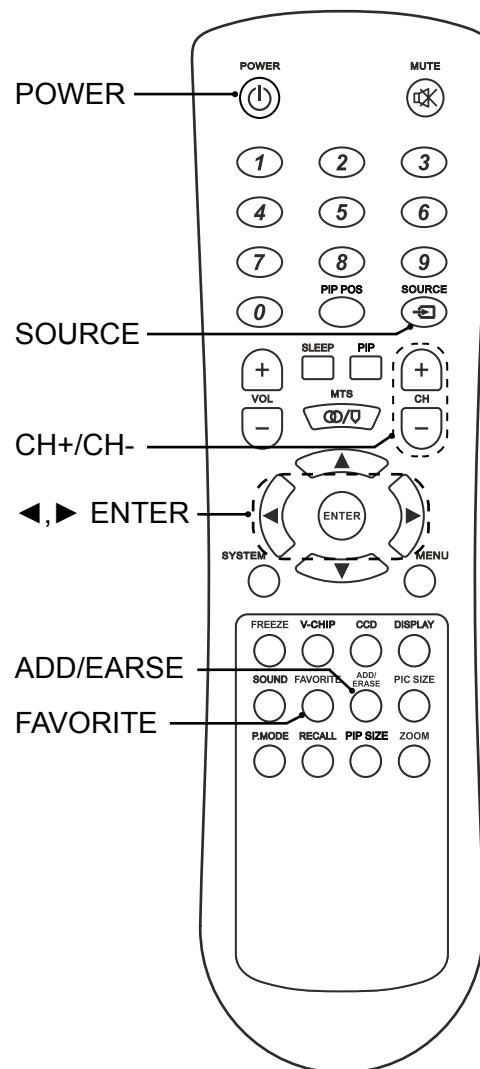

(Continued on next page)

- Note:* - If you don't want do add/erase this channel to/from the list of favorite, press this button again.
 - For addition, it will be put at last of the favorite list and the first channel in favorite list will overflow in case of the list is full.

SLEEP:

- Press repeatedly until it displays the time in minutes (5 Min, 10 Min, 15 Min, 30 Min, 60Min, 90 Min, 120 Min and OFF) that you want the TV to remain on before shutting off.

Note: When in one minute before shutting off. A "Turn off by Timer setting" wording will appear, you can press ◀ or ▶ button to selected, press "ENTER" to confirm. If select "OK", the LCD-TV will turn off immediately, if select "Cancel", it will cancel sleep time.

RECALL :

- Press to switch between present channel and previous channel.

Note: If the previous channel is a locked channel, it display blue background and lock information.

FREEZE:

- Press it to hold the current video and press again to cancel and return to normal viewing.

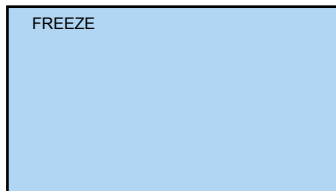

ZOOM :

- Press to zoom the image.

DISPLAY:

- Press once to display the information as following, and disappear after 3 second;

When in TV mode

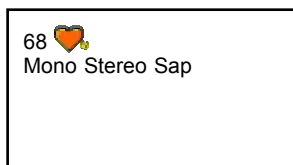

When in VGA mode

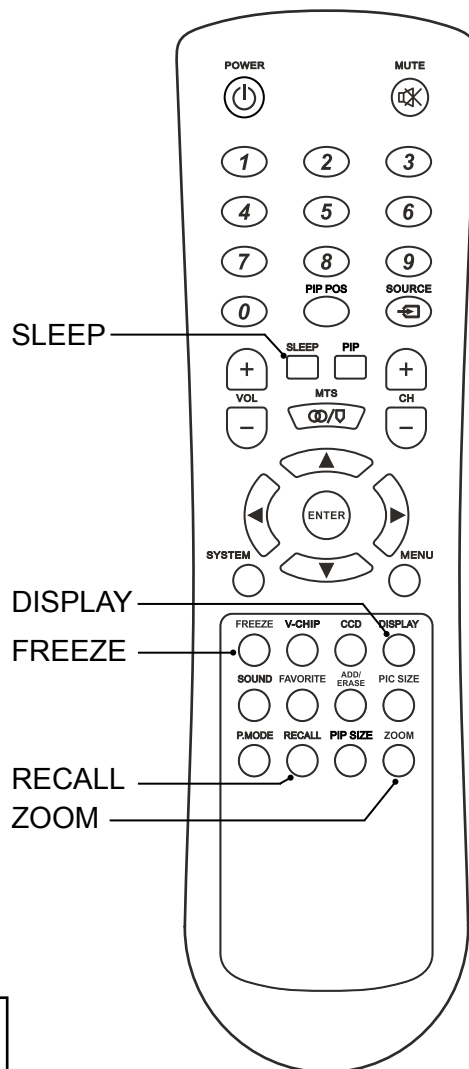
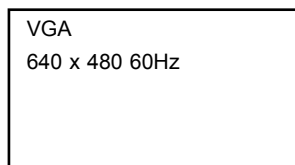

(Continued on next page)

6.4 Using the POP double-window feature

The POP (picture-out-picture) feature splits the screen into a double window that allows you to watch two programs at the same time. The POP program can come from a TV broadcast or an external source, such as a VCR.

To display a TV broadcast in the POP window:

1. Press **PIP** button to enter the POP window.

- ① Press PIP for selecting the different POP modes, such as following;

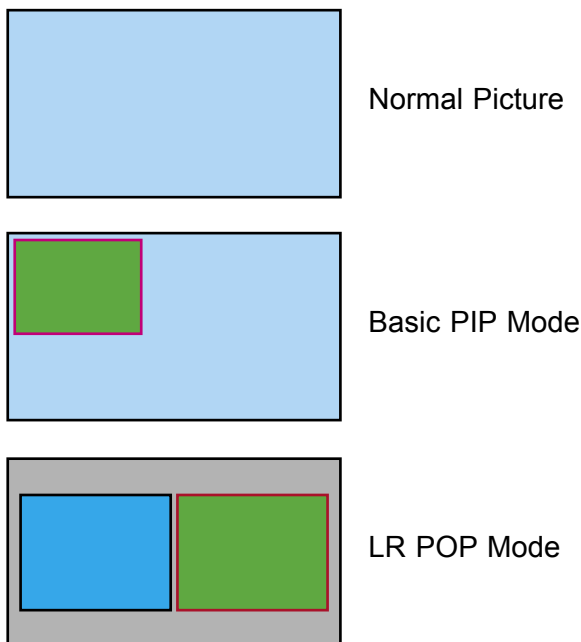

- ② Use ◀/▶ to select the window and active it with a red-colored frame.
- ③ Press **SOURCE** to select the input source for the POP window.

2. To change the next programmed channels, press number buttons (0~9) or CH+/CH-.

- Note:*
- a. If the V-CHIP feature is active and you try to watch a TV program that exceeds your set rating limits, the program will be blocked.
 - b. For active window, you can change channels, adjust volume, select input source ect.. After power off, the active window will be keep the setting when you power on next time.
 - c. It is must to have second video source connected for basic PIP and L/R POP modes.

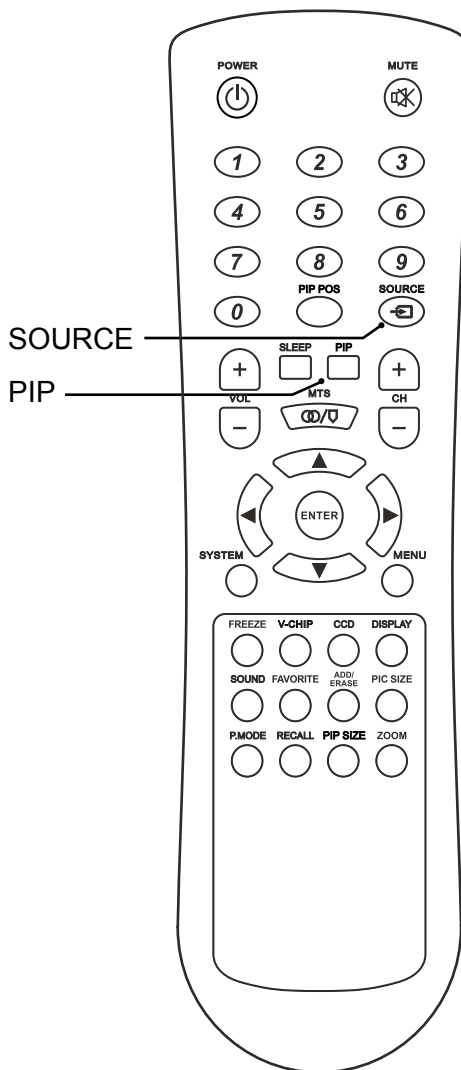

(Continued on next page)

To display a picture from an external source in the POP window:

1. Connect the external source equipment. (refer to Connect Accessory Devices page).
2. Select the TV program you want to watch in the main window.
3. Press PIP to display the POP window.
4. Repeatedly press **SOURCE** to select the input source for the POP window.

To change the PIP picture size:

Press PIP SIZE button to select the PIP picture size, such as: Small, Middle, Large.

To change the PIP position:

Press PIP POS button to change the PIP window position under PIP mode, it display as following;

Right Down → Left Down → Left Up →
Right Up → Right Down

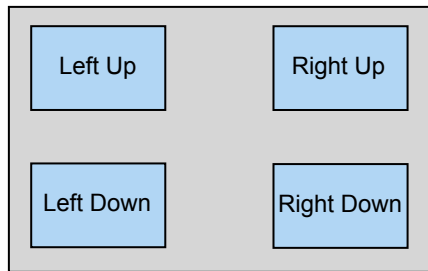

Switching the pictures:

When in Basic PIP mode, press “**ENTER**” to swap main or sub pictures; When in LR POP mode, press “**ENTER**” swap the L/R pictures.

To change Main or Sub sound:

When the red frame is displaying in main window, the sound goes out of main window source. If it display in sub window, the sound goes out of sub window source.

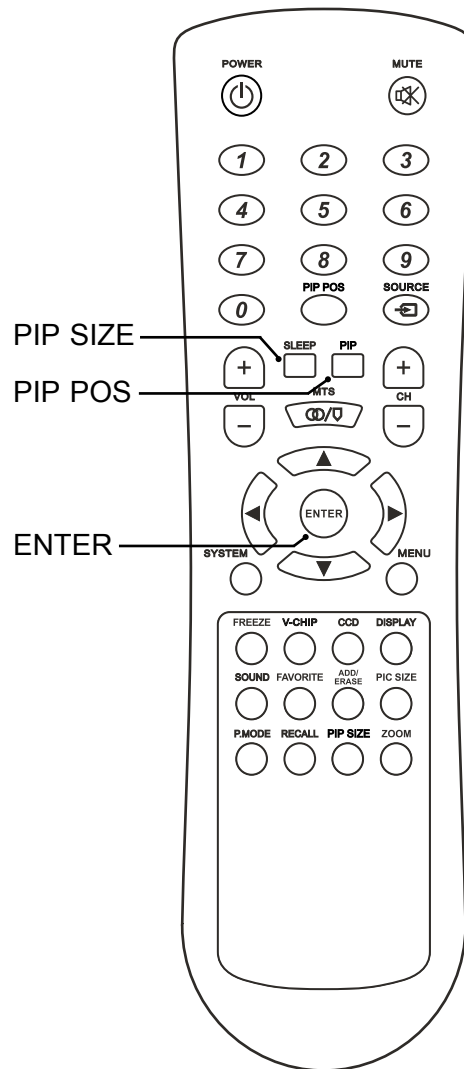

6.5 OSD Option Adjustment

Learning about the menu system

After you have installed the batteries and programmed the remote control, you will need to set some preferences on the TV using the menu system. You can access the menu using the buttons on your TV or remote control.

The OSD menu displayed in the following sequence (circular display):

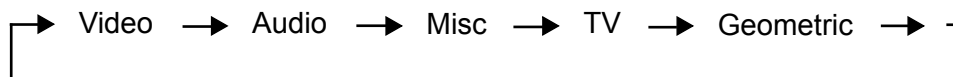

(Continued on next page)

- 1 Press **MENU** to display the menu system.
- 2 Press **◀/▶** to select a menu.
- 3 Press **▲/▼** to select an item.
- 4 Press **ENTER** on the remote control or **SOURCE** on the TV control panel to activate the function settings in the menu.
- 5 Press **▲,▼,◀,▶** to select or adjust a setting, press **ENTER** to confirm.
- 6 If you do not make a selection within 15 seconds, the main menu closes automatically; the other menus close automatically within 6 seconds.
- 7 Press **◀** to return OSD-menu.
- 8 To close an on-screen menu instantly, press **MENU** on the remote control or **MENU** on the control panel.

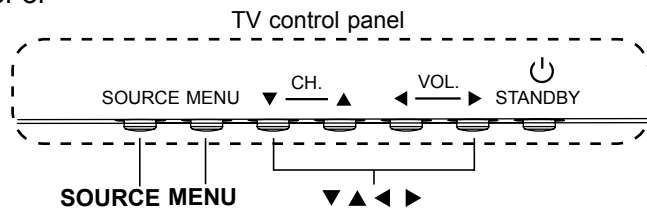
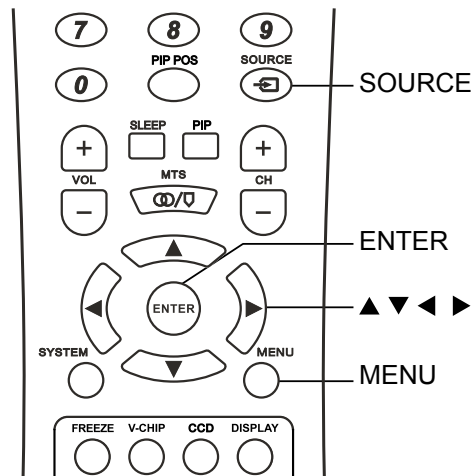

6.6 OSD Functions

1 Using the Video Menu

Option	Press ▲/▼	Description
Contrast	0~100	Reduce/Enhance
Brightness	0~100	Darken/Brighten
Back Light	Bright, Middle, Dark	Adjust the balance of back light
Saturation	0~100	Decrease/Increase of color
Hue	-30~+30	Decrease/Increase
Sharpness	0~7	Soften/Sharpen
Phase	0~31	Decrease/Increase
Color Temperature	Cool, Middle, Warm, User	Adjust the balance of whitening
Advanced Picture Adjust		Adjust the picture effect

Note: Video Menu is just for TV, AV, S-Video, Component 1 and Component 2 input source mode. It is not available in other input source mode.

(Continued on next page)

■ Adjustment of “Contrast”

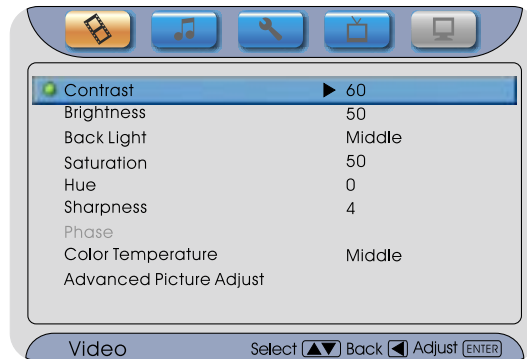

- ① Press **MENU** on the remote control, and then press ◀ or ▶ until the “Video” menu appears.
- ② Press ▲ or ▼ to highlight the item.
- ③ Press “**ENTER**” to confirm and display a status bar as below.

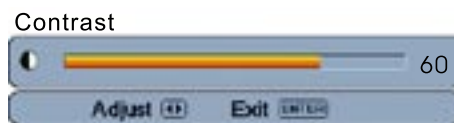

- ④ Press ◀ to decrease that will soften the color. Press ▶ to increase that will make white area more bright.
- ⑤ Press “**ENTER**” to confirm the adjustment and return.

■ Adjustment of “Brightness”

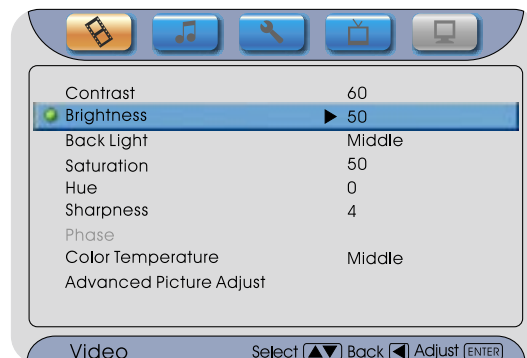

- ① Press **MENU**, and then press ◀ or ▶ until the “Video” menu appears.
- ② Press ▲ or ▼ to highlight the item.
- ③ Press “**ENTER**” to confirm and display a status bar as below.

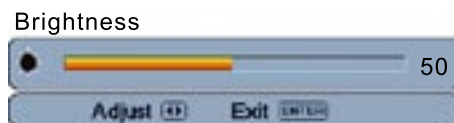

- ④ Press ◀ to decrease. Press ▶ to increase that will brighten the dark area for seeing the objects in shadowiness more clear.
- ⑤ Press “**Enter**” to confirm the adjustment and return.

(Continued on next page)

■ Adjustment of “Back Light”

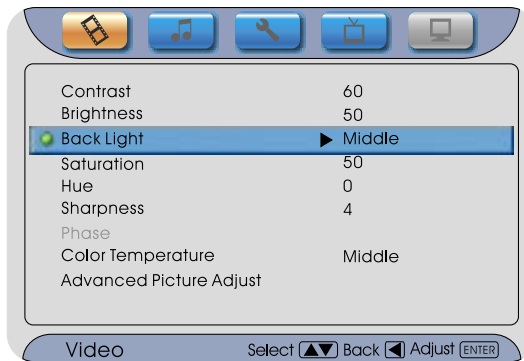

- 1 Press **MENU**, and then press ◀ or ▶ until the “Video” menu appears.
- 2 Press ▲ or ▼ to highlight the item.
- 3 Press “**ENTER**” and then press ▲ or ▼ to select one of “Bright”, “Middle” or “Dark” for the balance of back light.
- 4 Press “**ENTER**” to confirm the adjustment. Press ◀ to return.

■ Adjustment of “Saturation”

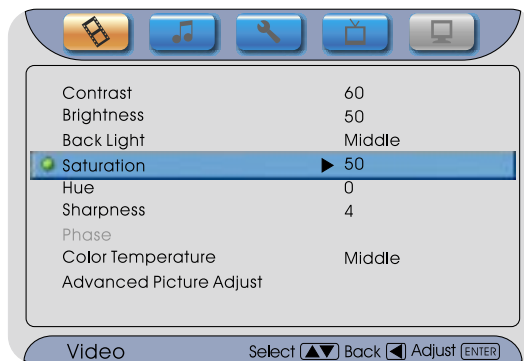

- 1 Press **MENU**, and then press ◀ or ▶ until the “Video” menu appears.
- 2 Press ▲ or ▼ to highlight the item.
- 3 Press “**ENTER**” to confirm and display a status bar as below.

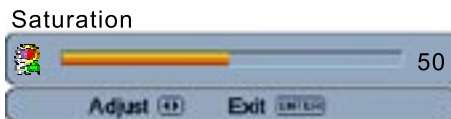

- 4 Press ◀ to decrease. Press ▶ to increase that will make color more intensive.
- 5 Press “**ENTER**” to confirm the adjustment and return.

(Continued on next page)

■ Adjustment of “Hue”

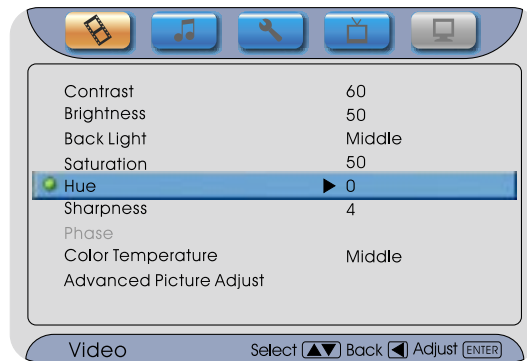

- ① Press **MENU**, and then press ◀ or ▶ until the “Video” menu appears.
- ② Press ▲ or ▼ to highlight the item.
- ③ Press “**ENTER**” to confirm and display a status bar as below.

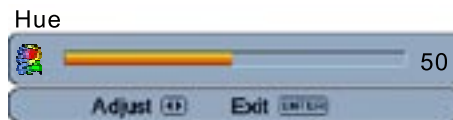

- ④ Press ◀ to decrease that will make image more green. Press ▶ to increase that will make image more red.
- ⑤ Press “**ENTER**” to confirm the adjustment and return.

■ Adjustment of “Sharpness”

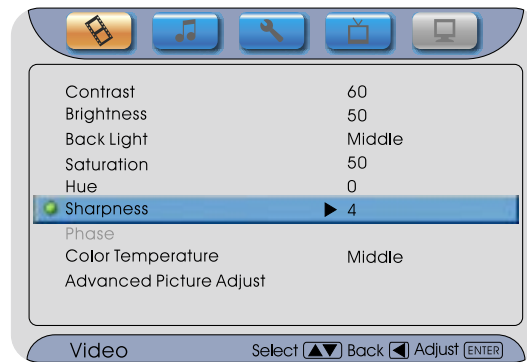

- ① Press **MENU**, and then press ◀ or ▶ until the “Video” menu appears.
- ② Press ▲ or ▼ to highlight the item.
- ③ Press “**ENTER**” to confirm and display a status bar as below.

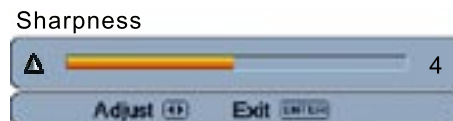

- ④ Press ◀ or ▶ to increase or decrease that will make image with more sharp edge.
- ⑤ Press “**ENTER**” to confirm the adjustment and return.

(Continued on next page)

■ Selection of “Phase” setting

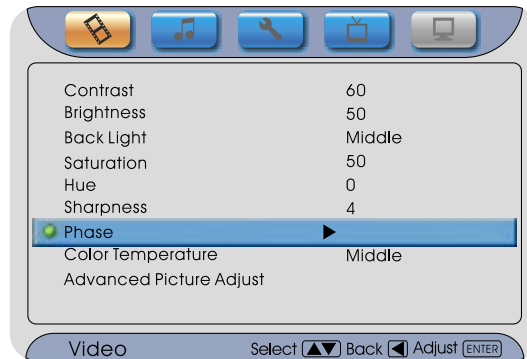

- 1 Press **MENU**, and then press ◀ or ▶ until the “Video” menu appears.
- 2 Press ▲ or ▼ to highlight the item.
- 3 Press “**ENTER**” to confirm and display a status bar as below.

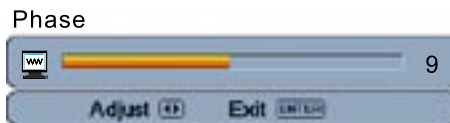

- 4 Press ◀ to decrease. Press ▶ to increase.
- 5 Press “**ENTER**” to confirm the adjustment and return.

Note: This is a feature just used for COMPONENT input source.

■ Selection of “Color Temperature”



- 1 Press **MENU**, and then press ◀ or ▶ until the “Video” menu appears.
- 2 Press ▲ or ▼ to highlight the item.
- 3 Press “**ENTER**” to confirm.
- 4 Press ▲ or ▼ to select one of “Cool”, “Middle”, “Warm” or “User” for balance of whitening.
- 5 Press “**ENTER**” to confirm the selection.
- 6 Press ◀ to return.

(Continued on next page)

If you select the item of “User”, a status bar below comes up for you to adjust the color temperature to your desirable value.

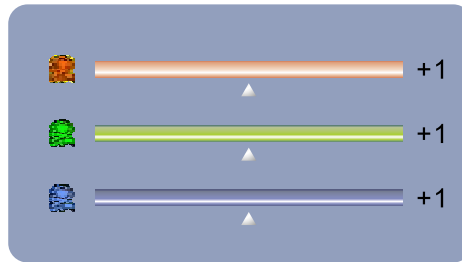

■ Selection of “Advance Picture Adjust”

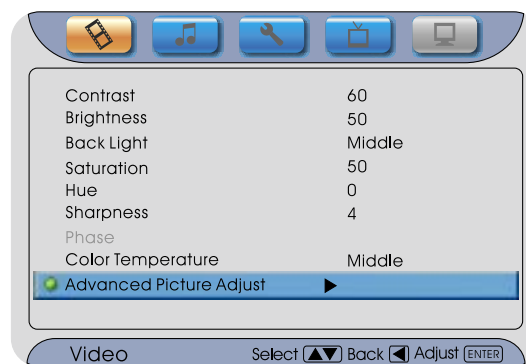

- ① Press **MENU**, and then press ◀ or ▶ until the “Video” menu appears.
- ② Press ▲ or ▼ to highlight the item.
- ③ Press **“ENTER”** to confirm for sub-selection as shown in the table below.

Table of Auto Adjustment Setting

Item	Status	Description
DNR	Off, Low, Middle, Strong	Selecting to control the sharpness and noise reduction.
White Peak Limitator	On, Off	Select “On” to limit the white peak.
CTI	Low, Middle, Strong, Off	Select dynamic color improve level.
Flesh Tone	On, Off	Select “On” to correct the flesh tone automatically.
Adaptive Luma Control	On, Off	Selecting to control the lum.

- ④ Press **“ENTER”** to confirm the selection.
- ⑤ Press ◀ to return.

(Continued on next page)

2 Using the Audio Menu

Option	Press ▲/▼	Description
Bass	0~100	Decrease/Increase
Treble	0~100	Decrease/Increase
Balance	-20~+20	Emphasize left/right speaker
Surround	On, Off	

■ Adjustment of “Bass”

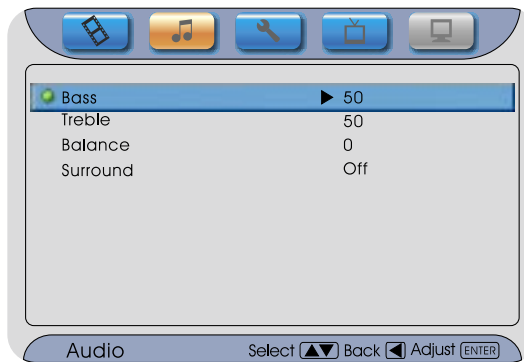

- ① Press **MENU**, and then press ◀ or ▶ until the “Audio” menu appears.
- ② Press ▲ or ▼ to highlight the item.
- ③ Press “**ENTER**” to confirm and display a status bar as below.

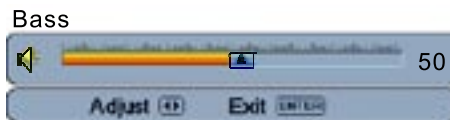

- ④ Press ◀ to decrease the Bass sound. Press ▶ to increase it.
- ⑤ Press “**ENTER**” to confirm and return.

■ Adjustment of “Treble”

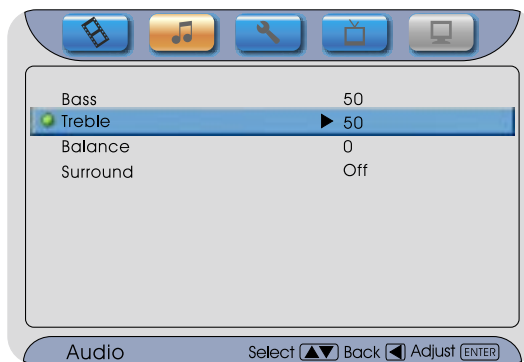

(Continued on next page)

- ① Press **MENU**, and then press ◀ or ▶ until the “Audio” menu appears.
- ② Press ▲ or ▼ to highlight the item.
- ③ Press “**ENTER**” to confirm and display a status bar as below.

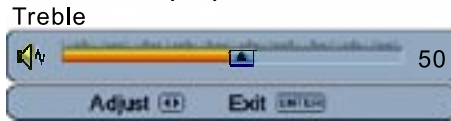

- ④ Press ◀ to decrease the treble sound, press ▶ to increase it.
- ⑤ Press “**ENTER**” to confirm and return.

■ Adjustment of “Balance”

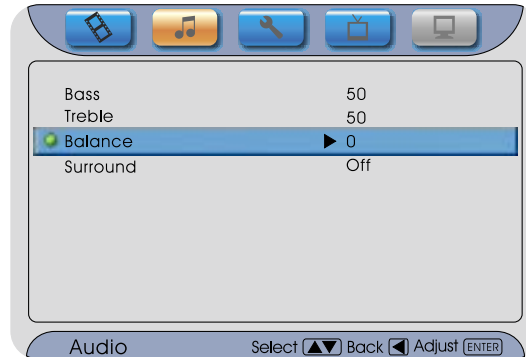

- ① Press **MENU**, and then press ◀ or ▶ until the “Audio” menu appears.
- ② Press ▲ or ▼ to highlight the item.
- ③ Press “**ENTER**” to confirm and display a status bar as below.

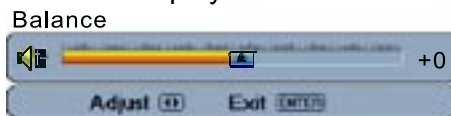

- ④ Press ◀ to emphasize the left speaker. Press ▶ to emphasize the right speaker.
- ⑤ Press “**ENTER**” to confirm and return.

■ Selection of “Surround”

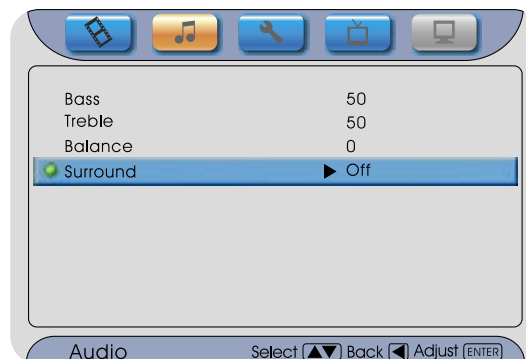

- ① Press **MENU**, and then press ◀ or ▶ until the “Audio” menu appears.
- ② Press ▲ or ▼ to highlight the item.
- ③ Press “**ENTER**” to confirm.
- ④ Press ▲ or ▼ to select “On” or “Off”.
- ⑤ Press “**ENTER**” to confirm your selection.
- ⑥ Press ◀ to return.

(Continued on next page)

3 Using the Miscellaneous Menu

Option	Press ▲/▼	Description
Language	English, Français, Español	Select the OSD language
Closed Caption	C1, C2, C3, C4, T1, T2, T3, T4, Off	To select Captions or Text
V-Chip		Enter to V-Chip function
Parental		Enter to Parental function
Blue Mute	On, Off	Select it to set screen to pleasant blue background
Default		Select to restore factory default settings.

■ Selection of “Language”

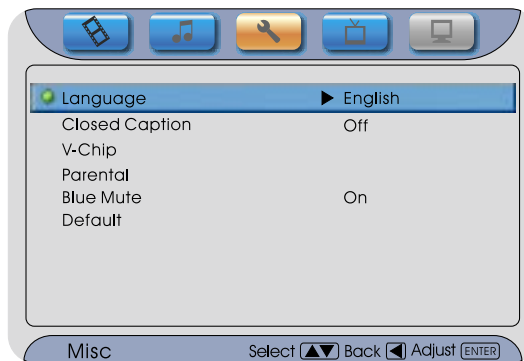

- ① Press **MENU**, and then press ◀ or ▶ until the “Misc” menu appears.
- ② Press ▲ or ▼ to highlight the item.
- ③ Press “**ENTER**” to confirm.
- ④ Press ▲ or ▼ to choose the OSD language.
- ⑤ Press “**ENTER**” to confirm your selection.
- ⑥ Press ◀ to return.

■ Selection of “Closed Caption”

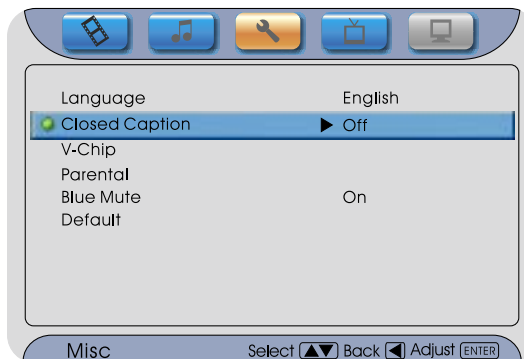

(Continued on next page)

The closed caption features has two options:

Adjustment only for TV, AV, S-VIDEO input signal.

- **Captions:** An on-screen display of the dialogue, narration, and sound effects of the TV programs and videos that are closed captioned (usually marked as "C/C" in TV listings).
- **Text :** An on-screen display of information not related to the current program, such as weather or stock data (when provided by individual stations).

To view captions or text:

- 1 Press **MENU**, and then press ◀ or ▶ until the "Misc" menu appears.
- 2 Press ▲ or ▼ to highlight the item.
- 3 Press **"ENTER"** to confirm.
- 4 Press ▲ or ▼ to choose one of "C1", "C2", "C3", "C4", "T1", "T2", "T3", "T4", as follows:
 - To view captions, highlight C1, C2, C3, or C4 (C1 displays translation of the primary language in your area).



Note: If the program or video you selected is not closed captioned, no captions will display on-screen.

- To view text, highlight T1, T2, T3, or T4.

World Weather	Temp		Current Weather
	F	C	
New York	53	12	Sunny
London	51	11	Cloudy
HongKong	80	25	Clear

Note: If text is not available in your area, a black rectangle may appear on-screen. If this happens, turn off the Closed Caption feature.

Note: A closed caption signal may not display in the following situations:

- when a videotape has been dubbed
- when the signal reception is weak
- when the signal reception is nonstandard

- 5 Select "Off" to close this function.
- 6 Press **"ENTER"** to confirm your selection.
- 7 Press ◀ to return.

Hot keys:

- You can also press CCD on the remote control to select you desired item.

■ Setting of “V-Chip”

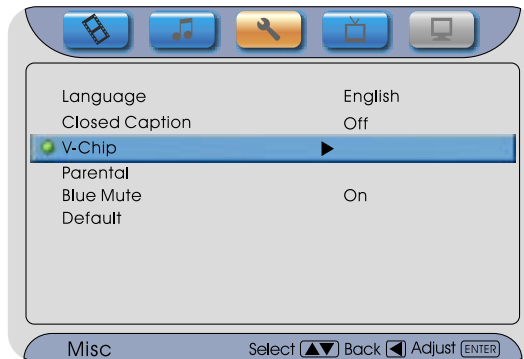

Some programs and movies include signals that classify the content of the program (dialog, language, sex, violence). The “V-Chip” control feature in this detects the signals and blocks the programs according to your selections. To use this feature, perform the following setup.

Adjustment only for TV, AV, S-VIDEO input signal.

- ① Press **MENU**, and then press ◀ or ▶ until the “Misc” menu appears.
- ② Press ▲ or ▼ to highlight the item.
- ③ Press **“ENTER”** to confirm.

The “V-Chip” menu includes the “V-Chip Control”, “Block MPA Rating”, and “Block TV Rating” functions. You can use these functions after entering the correct PIN code.

Entering the PIN code

- Blocking Reset status:
Set your 4-digit code by pressing the Number buttons (0~9), and then press **ENTER**.
- When the PIN code is already stored:
Press the Number buttons (0~9) to enter the 4-digit PIN code used for blocking channels, and then press **ENTER**.

Note: The initial password for the system is “0000”.

If you had forgotten the password, please contact with service centre.

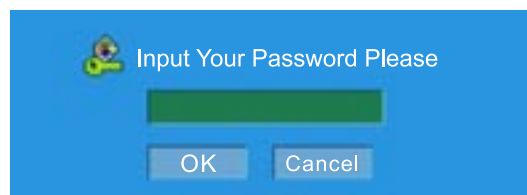

If the input is invalid, a message will pop up as below;

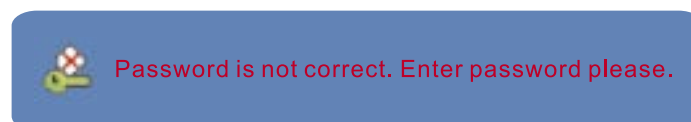

(Continued on next page)

You can press **“ENTER”** to display **“Input Your Password Please”** menu again, then entering the PIN code, or press **“▼ , ▲ , ◀ or ▶”** move cursor to **“Cancel”** and press **“ENTER”** button to close up this menu.

* Using the **“V-Chip Control”** item

- ① When enter the **“V-CHIP”** menu, select **“V-Chip Control”**.
- ② Press **▲** or **▼** to highlight the **“V-Chip Control”** item.
- ③ Press **“ENTER”** to confirm and then press **▲** or **▼** to select **“ON”** or **“OFF”**.
 ON : TV Blocking and MPAA Blocking are activate.
 OFF: TV Blocking and MPAA Blocking are not activate.
- ④ Press **◀** to return or press **MENU** to exit.

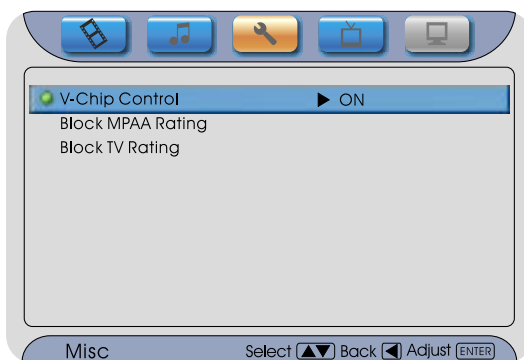

* Using the **“Block MPAA Rating”** item

- ① When enter the **“V-CHIP”** menu, select **“Block MPAA Rating”**.
- ② Press **▲** or **▼** to highlight the **“Block MPAA Rating”** item.
- ③ Press **“ENTER”** to confirm.
- ④ Press **▲** or **▼** to select an item, then press **“ENTER”** to lock (display **“☑”**) or unlock (display **“☒”**).

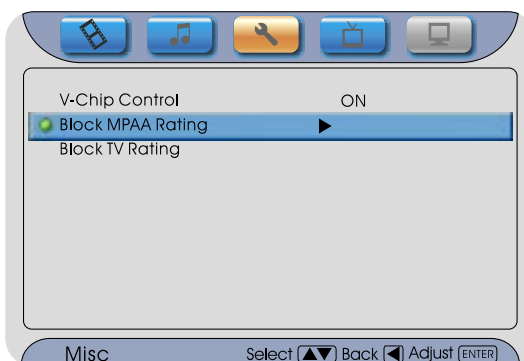

G	<input checked="" type="checkbox"/>
PG	<input checked="" type="checkbox"/>
PG-13	<input checked="" type="checkbox"/>
R	<input checked="" type="checkbox"/>
NC-17	<input checked="" type="checkbox"/>
X	<input checked="" type="checkbox"/>
<input checked="" type="checkbox"/> Block Rating	<input checked="" type="checkbox"/> Allowed Rating

(Continued on next page)

The movie block you can lock are described as follows:

Item	Description and Content themes
G	General Audience (Appropriate for all ages)
PG	Parental Guidance Suggested (Some material may not be suitable for children)
PG-13	Parents Strongly Cautioned (Some material may be inappropriate for children under 13)
R	Restricted (Under 17 requires accompanying parent or adult guardian)
NC-17	Not intended for anyone 17 and under
X	X-rated (For adults only)

⑤ Press **MENU** button to exit the sub-menu.

* Using the “Block TV Rating” item

- ① From the “V-CHIP” menu, select “Block TV Rating”.
- ② Press ▲ or ▼ to highlight the “Block TV Rating” item.
- ③ Press “ENTER” to confirm.
- ④ Press ▲ , ▼ , ◀ , ▶ to select an item, then press “ENTER” to lock (display “☑ ”) or unlock (display “☒ ”).

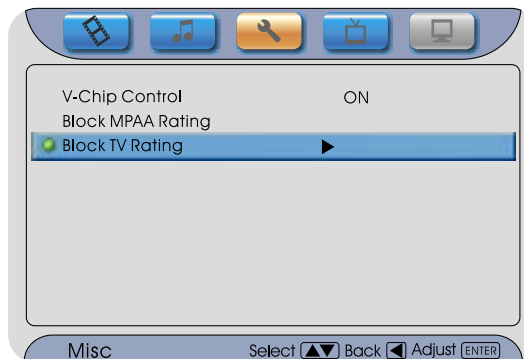

	F	V	S	L	D
TV-Y	☒				
TV-Y7	☒	☒			
TV-G	☒				
TV-PG	☒		☒	☒	☒
TV-14	☒		☒	☒	☒
TV-MA	☒		☒	☒	☒
<input checked="" type="checkbox"/> Block Rating	<input checked="" type="checkbox"/>				
<input checked="" type="checkbox"/> Allowed Rating	<input checked="" type="checkbox"/>				

(Continued on next page)

The aged-based TV Guideline and content themes you can lock are listed as follows:

Item	Description and Content themes
TV-Y	All Children (This program is designed to be appropriate for all children.)
TV-Y7	Directed to Older Children (This program is designed for children age 7 and above. <i>Note: Programs in which fantasy violence may be more intense or more combative than other programs in this category are designed TV-Y7.</i>)
TV-G	General Audience (Most parents would find this program suitable for all ages.)
TV-PG	Parental Guidance Suggested (This program contains material that parents may find unsuitable for younger children.) D) Some suggestive dialog L) Infrequent coarse language S) Some sexual situations V) Moderate violence
TV-14	Parents Strongly Cautioned (This program contains some material that many parents would find unsuitable for children under 14 years of age.) D) Intensely suggestive dialog L) Strong, coarse language S) Intense sexual situations V) Intense violence
TV-MA	Mature Audience Only (This program is specifically designed to be viewed by adults and therefore may be unsuitable for children under 17.) L) Crude or indecent language S) Explicit sexual activity V) Graphic violence

⑤ Press **MENU** button to exit the sub-menu.

Unlocking programs temporarily

- ① If you try to watch a TV program that exceeds the TV Guideline you set, the TV enters program lock mode. You can either unlock the program temporarily or select a non-locked program to watch, press ▲ or ▼ to select the program.
- ② To temporarily unlock the program, press the Number buttons (0~9) to enter your 4-digit PIN code.

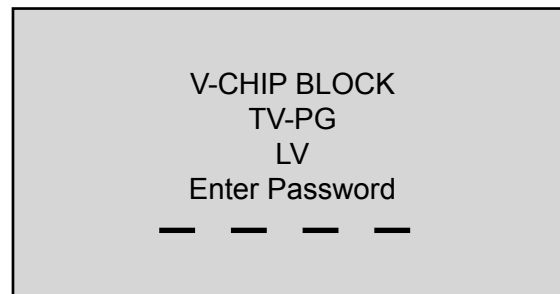

If the correct code is entered, the program lock mode is released and the normal picture appears.

Hot keys:

- You can also press V-CHIP on the remote control to enter V-Chip menu.

■ Setting of “Parental”

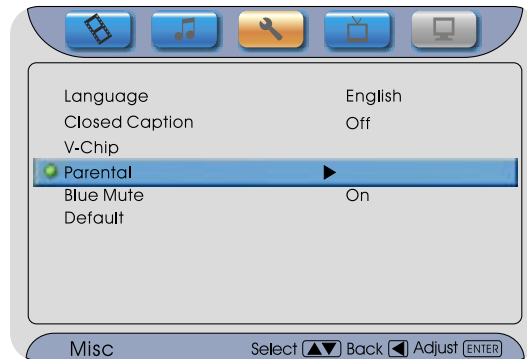

The TV programs and movies shown on TV are given a rating signal based on the following rating systems.

To block programs you feel unsuitable for your children, you need to set the TV for the desired rating systems. The TV's “Parental” control feature functions by receiving the rating signal from your local broadcasting station or cable service provider.

- ① Press **MENU**, and then press ◀ or ▶ until the “Misc” menu appears.
- ② Press ▲ or ▼ to highlight the item.
- ③ Press **“ENTER”** to confirm.

The “Parental” menu includes the “Channel Lock”, “Video Lock”, “Change Password” and “Clear All” functions.

You can use these functions after entering the correct PIN code.

Entering the PIN code

- Blocking Reset status:
Set your 4-digit code by pressing the Number buttons (0~9), and then press **ENTER**.
- When the PIN code is already stored:
Press the Number buttons (0~9) to enter the 4-digit PIN code used for blocking channels, and then press **ENTER**.

Note: The initial password for the system is “0000”.

If you had forgotten the password, please contact with service centre.

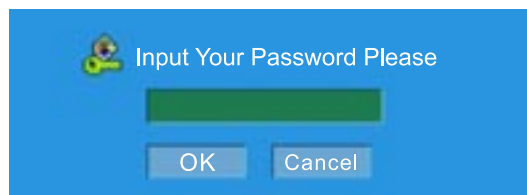

If the input is invalid, a message will pop up as below;

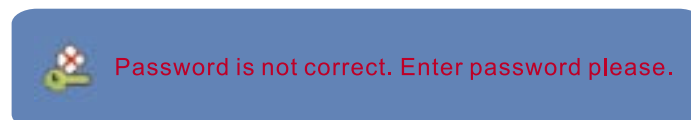

(Continued on next page)

You can press “**ENTER**” to display “Input Your Password Please” menu again, then entering the PIN code, or press “**▼**, **▲**, **◀** or **▶**” move cursor to “Cancel” and press “**ENTER**” button to close up this menu.



- ④ Press **▲** or **▼** to choose an item as below table showing.
- ⑤ Press “**ENTER**” to confirm.
- ⑥ Press **◀** to return.

Table of Parental Setting

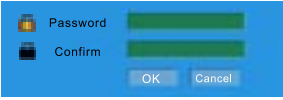
Items	Status	Description
Channel Lock	All channels	Use the CH+/CH- or ▲ / ▼ and ENTER buttons to select the channel you desired to lock.
Video Lock	TV1, AV, S-Video, Component 1, Component 2, DVI, VGA	Use ▲ / ▼ and ENTER buttons to select the Video you desired to lock.
Change Password		Enter a new 4-digit code by using the number keys on the remote, and then confirm the new code by entering it a second time, press “ ENTER ” to confirm. It will exit this menu when your code has been successfully changed.
Clear All		Press “ ENTER ” to clear all present Parental setting.

■ Selection of “Blue Mute”

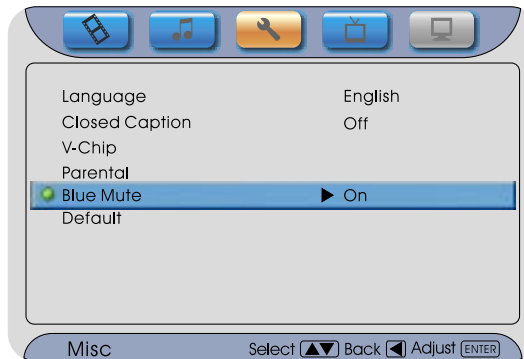

- 1 Press **MENU**, and then press ◀ or ▶ until the “Misc” menu appears.
- 2 Press ▲ or ▼ to highlight the item.
- 3 Press “**ENTER**” to confirm.
- 4 Press ▲ or ▼ to choose “On” or “Off”, when select “On” to set screen to a pleasant blue background when it detects no signal available if turn on.
- 5 Press “**ENTER**” to confirm your selection.
- 6 Press ◀ to return.

■ Using “Default”

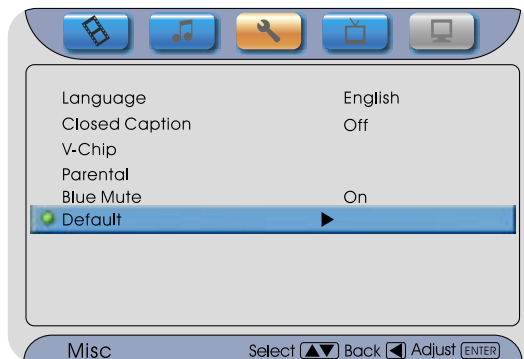

- 1 Press **MENU**, and then press ◀ or ▶ until the “Misc” menu appears.
- 2 Press ▲ or ▼ to highlight the item.
- 3 Press “**ENTER**” to confirm, it will reset to restore factory default settings. After that, a confirmation message will pop up.

Note: Just reset the items in the setup menu don't include the protected-items(Needs pin code enter, such as password, video lock, and channel lock) and properties such as skipped channel, channel name.

4 Using the TV Menu

Option	Press ▲/▼	Description
Auto Search		To searching the channel
Tuner Mode	Cable, Air	To select the tuner mode
Channel Skip		To skip the channel
Channel Name		Add the channel name

Note:

- ① TV menu is only for TV input source mode, thus it is not available in other input source mode.
- ② The locked channel will be skipped during the searching.

■ Using the “Auto Search”

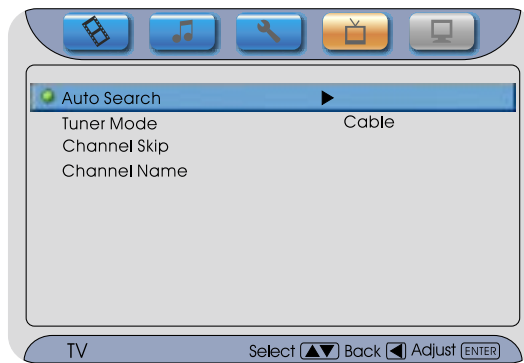

- ① Press **MENU**, and then press ◀ or ▶ until the “TV” menu appears.
- ② Press ▲ or ▼ to highlight the item.
- ③ Press “**ENTER**” to confirm.
- ④ Press ◀ to return.

■ Using the “Tuner Mode”

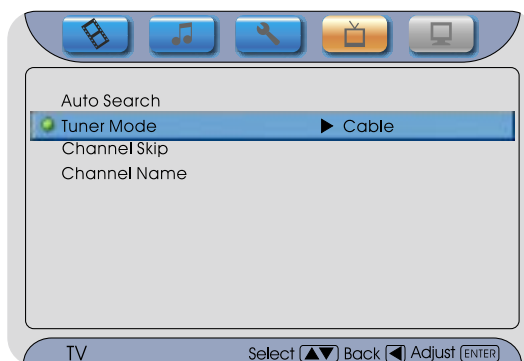

(Continued on next page)

OPERATING INSTRUCTIONS

OSD FUNCTIONS---TV MENU---GEOMETRIC MENU

- 1 Press **MENU**, and then press ◀ or ▶ until the “TV” menu appears.
- 2 Press ▲ or ▼ to highlight the item.
- 3 Press “**ENTER**” to confirm.
- 4 Press ▲ or ▼ to choose “Air” or “Cable”.
- 5 Press “**ENTER**” to confirm.
- 6 Press ◀ to return.

■ Using the “Channel Skip”

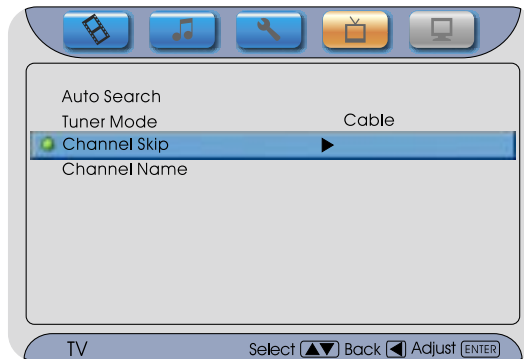

- 1 Press **MENU**, and then press ◀ or ▶ until the “TV” menu appears.
- 2 Press ▲ or ▼ to highlight the item.
- 3 Press “**ENTER**” to confirm.
- 4 Press ▲ or ▼ to scan which channel is skipped, there is a the channel.
- 5 Press “**ENTER**” to toggle the channel will be skipped or not.
- 6 Press ◀ to return.

■ Using the “Channel Name”

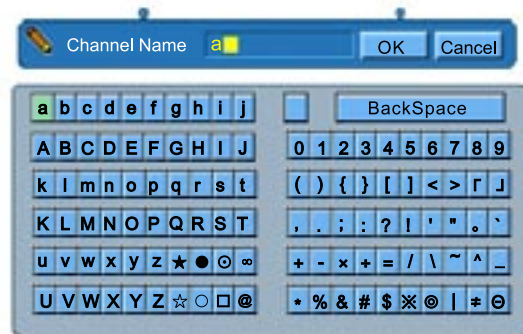
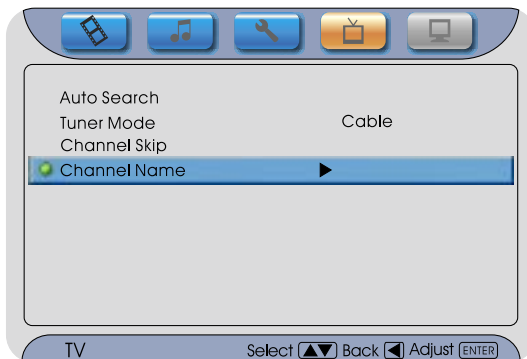

- 1 Press **MENU**, and then press ◀ or ▶ until the “TV” menu appears.
- 2 Press ▲ or ▼ to highlight the item.
- 3 Press “**ENTER**” to confirm, it will display “Channel Name” list.
- 4 Use “◀, ▶, ▲, ▼” for select, and move cursor to “OK”, then press “**ENTER**” for confirm you selection. If you want to cancel this operation, move cursor to “Cancel” and press “**ENTER**” for close this setting.
- 6 Press ◀ to return.

Note: It will be invalid if the current source is not TV.

■ Selecting Channel

- ① Press **CH+/-** on the remote control to search the channels, the channel number will increase or decrease by 1 for each pressing excluding the skipped channels.
- ② Press number buttons 0~9 to select the corresponding channel content. If the channel number is bigger than 9, just press the two number buttons successively. If the channel number is bigger than 100, just press the three number buttons successively. The time interval should not exceed 2 seconds.
- ③ If the channel number you pressed is bigger than the maximum channel number that the setting is permitted, the maximum numbered channel content will be remained.

■ Channel Preview

Press **RECALL** button to switch between present channel and previous channel.
(Only for TV)

5 Using the Geometric Menu

Option	Press ▲ / ▼	Description
Contrast	0~100	Reduce/Enhance
Brightness	0~100	Darken/Brighten
Back Light	Middle, Bright, Dark	Adjust the balance of back light
Auto Setting		To adjust the position of display automatically
Phase	0~31	Soften/Sharpen
Manual Clock	0~255	Decrease/Increase
Display Adjustment	Vertical position, Horizontal position	To adjust the position of display

Note:

- ① If your current input source is "VGA" or "DVI", push "MENU" enter into this menu. It is not available in other input source mode.
- ② "Auto Setting", "Phase", "Manual Clock" and "Display Adjustment" item can be adjust when input source is "VGA".

■ Using "Contrast"

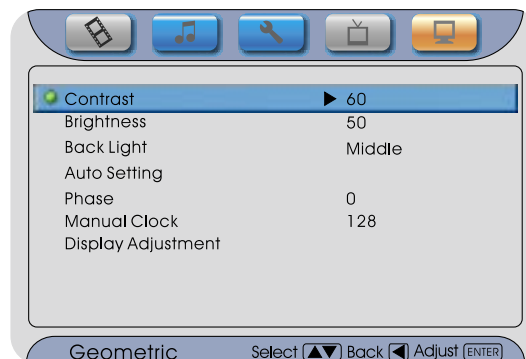

(Continued on next page)

- 1 Press **MENU** on the remote control, and then press ◀ or ▶ until the “Geometric” menu appears.
- 2 Press ▲ or ▼ to highlight the item.
- 3 Press “**ENTER**” to confirm and display a status bar as below.

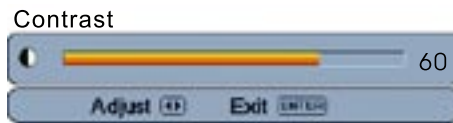

- 4 Press ◀ to decrease that will soften the color. Press ▶ to increase that will make white area more bright.
- 5 Press “**ENTER**” to confirm the adjustment and return.

■ Using “Brightness”

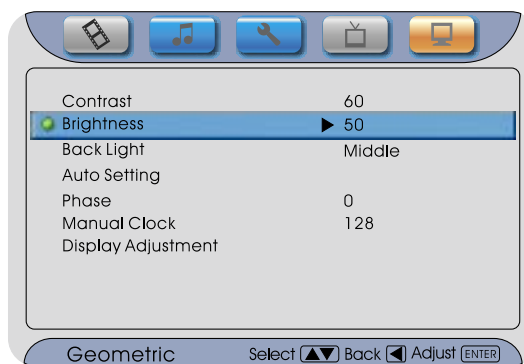

- 1 Press **MENU**, and then press ◀ or ▶ until the “Geometric” menu appears.
- 2 Press ▲ or ▼ to highlight the item.
- 3 Press “**ENTER**” to confirm and display a status bar as below.

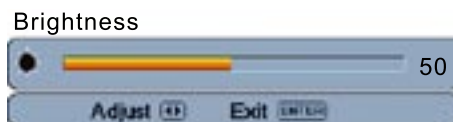

- 4 Press ◀ to decrease. Press ▶ to increase that will brighten the dark area for seeing the objects in shadowiness more clear.
- 5 Press “**ENTER**” to confirm the adjustment and return.

■ Using “Back Light”

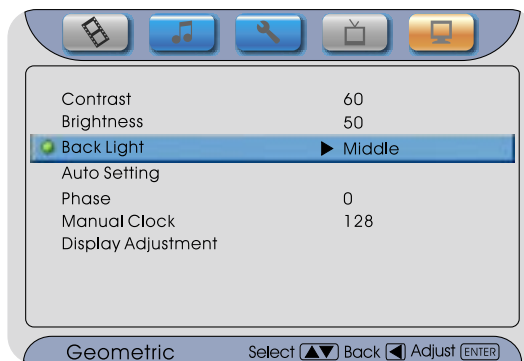

(Continued on next page)

- ① Press **MENU**, and then press ◀ or ▶ until the “Geometric” menu appears.
- ② Press ▲ or ▼ to highlight the item.
- ③ Press ▲ or ▼ to select one of “Bright”, “Middle” or “Dark” for the balance of back light.
- ④ Press **“ENTER”** to confirm the adjustment. Press ◀ to return.

■ Using “Auto Setting”

- ① Press **MENU**, and then press ◀ or ▶ until the “Geometric” menu appears.
- ② Press ▲ or ▼ to highlight the item.
- ③ Press **“ENTER”** to confirm.
- ④ Press ◀ to return.

Note:

This item will auto-adjust the picture display.

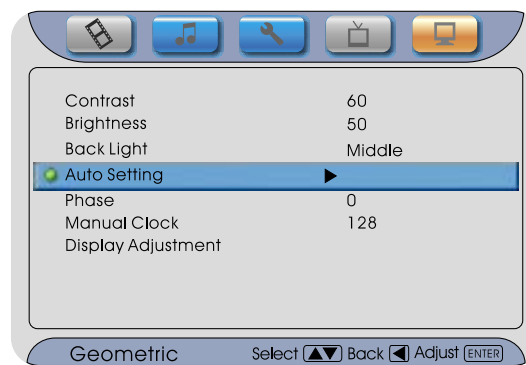

■ Using “Phase”

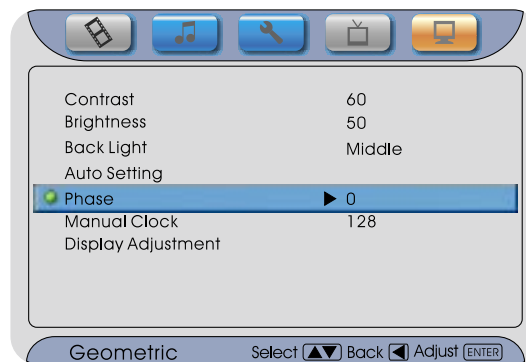

- ① Press **MENU**, and then press ◀ or ▶ until the “Geometric” menu appears.
- ② Press ▲ or ▼ to highlight the item.
- ③ Press **“ENTER”** to confirm and display a status bar as below.

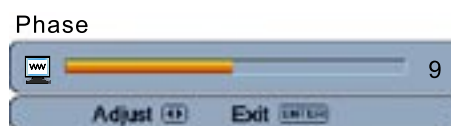

- ④ Press ◀ to decrease and press ▶ to increase it.
- ⑤ Press **“ENTER”** to confirm and return.

Note: This is a feature used for VGA input source.

■ Using “Manual Clock”

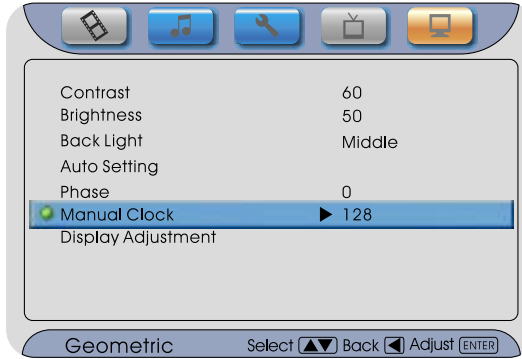

- ① Press **MENU**, and then press ◀ or ▶ until the “Geometric” menu appears.
- ② Press ▲ or ▼ to highlight the item.
- ③ Press “**ENTER**” to confirm and display a status bar as below.

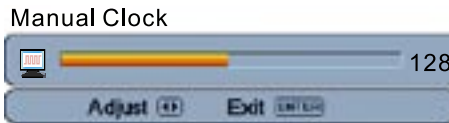

- ④ Press ◀ to decrease the menu clock. Press ▶ to increase it.
- ⑤ Press “**ENTER**” to confirm and return.

■ Using “Display Adjustment”

- ① Press **MENU**, and then press ◀ or ▶ until the “Geometric” menu appears.
- ② Press ▲ or ▼ to highlight the item.
- ③ Press “**ENTER**” to confirm for sub-selection as shown in the table below.
- ④ Press “**ENTER**” to confirm your selection.
- ⑤ Press ◀ to return.

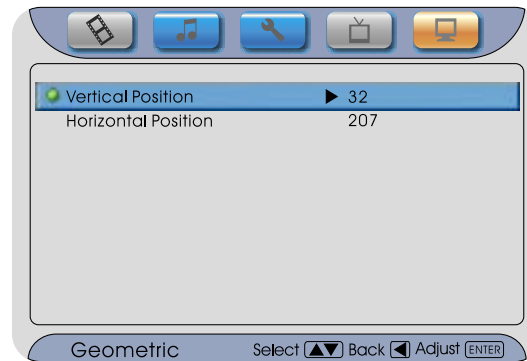
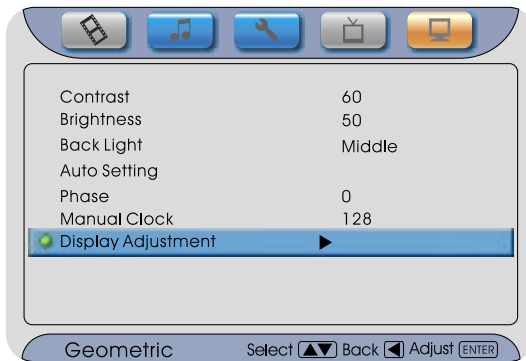

Table of Display Adjustment

Items	Description
Vertical Position	Use “▲” or “▼” to select it and press “ ENTER ” to confirm. Use “◀” or “▶” to move the image up or down.
Horizontal Position	Use “▲” or “▼” to select it and press “ ENTER ” to confirm. Use “◀” or “▶” to move the image left or right.

7. Technical Specification

Product Model:	LCT3226
Screen Size:	32" diagonal
Screen Area:	714.96mm(H) x 404.60mm(V)
Aspect Ratio:	16:9
External Size:	988mm(W) x 514mm(H) x 94mm(D) (w/o Stand) 988mm(W) x 562mm(H) x 235mm(D) (with Stand)
Net Weight:	18kg (with Stand)
Resolution:	1366 (H) x 768 (V) pixels (Each pixel has R/G/B 3 color cells)
Pixel Dot Pitch:	173 μ m(H) x 519 μ m(V)
Color:	16.7 millions of colors (R/G/B each 256 scales)
Gray Scale:	256 (R/G/B each 8-bit)
Brightness(Peak Value):	550cd/m ² (Typical)
Contrast(Dark Room):	1000:1 (Typical)
TV System:	NTSC M
Sound:	Mono, Stereo, SAP (BTSC)
Sound Effect:	Spatial Effect and Surround
Power Supply:	AC 100-240V, 50/60 Hz
Power Consumption:	≤ 200W
Input/Output Terminal:	D-Sub 15 Pin (Analog RGB Input) DVI with HDCP (29 Pin) x 1 Component Video - YPbPr/YCbCr x 2 RCA Terminals Video Input RCA Terminals S-Video Input Mini Din 4 Pin Terminal 1 set of Stereo Audio Output Terminals (RCA, L&R) Audio Input for DVI(HDCP) Audio Input for Video/S-Video Audio Input for YPbPr/YCbCr x 2 Audio Input for PC (3.5mm)
Agent System:	UL, cUL, FCC

NOTE:

The specifications shown above may be changed without notice for quality improvement.

8. Support the Signal Mode

A. D-Sub Mode (VGA and DVI)

NO.	Resolution	Horizontal Frequency (KHz)	Vertical Frequency (Hz)	Dot Clock Frequency (MHz)
1	640 x 480	31.50	60.00	25.18
2	640 x 480	35.00	67.00	30.24
3	640 x 480	37.50	75.00	31.50
4	640 x 480	37.86	72.81	31.50
5	720 x 400	31.47	70.08	28.32
6	800 x 600	35.16	56.25	36.00
7	800 x 600	37.90	60.32	40.00
8	800 x 600	46.90	75.00	49.50
9	800 x 600	48.08	72.19	50.00
10	832 x 624	49.00	75.00	57.27
11	1024 x 768	48.40	60.00	65.00
12	1024 x 768	56.50	70.00	75.00
13	1024 x 768	60.00	75.00	78.75
14	1152 x 864	63.86	70.02	94.51
15	1152 x 864	67.52	75.02	108.03
16	1280 x 960	60.02	60.02	108.04
17	1280 x 1024	64.00	60.01	108.00

B. HDTV Mode (YPbPr)

NO.	Resolution	Horizontal Frequency (KHz)	Vertical Frequency (Hz)	Dot Clock Frequency (MHz)
1	480i	15.734	59.94	13.50
2	480p(720x480)	31.468	59.94	27.00
3	576p(720x576)	31.25	50.00	27.00
4	720p(1280x720)	37.50	50.00	74.25
5	720p(1280x720)	45.00	60.00	74.25
6	1080i(1920x1080)	33.75	60.00	74.25

- When the signal received by the Display exceeds the allowed range, a warning message "Main no support" shall appear on the screen.
- You can confirm the input signal format from the on-screen.

9. Cleaning and Simple Troubleshooting

1 Important:

- Make sure that the power cable is removed from the AC outlet before cleaning the product.
- Do not use volatile solvent (such as toluene, rosin and alcohol) to clean the Display. Such chemicals may damage the housing, screen glass and remote control, and cause the paint to peel.

2 Cleaning of Housing and Remote Control:

- Use a soft cotton cloth for cleaning.
- If the housing or remote control are seriously contaminated, use a soft cloth moistened with diluted neutral clean the Display. Wring water out of the cloth before cleaning to prevent water from penetrating into the housing. Wipe the Display with a dry cloth after cleaning.

3 Cleaning of Screen:

- Use a soft cotton cloth to clean the screen gently.
- The screen glass is very fragile; so do not scrape it with any sharp object. Do not press or tap the screen to avoid cracking. When the screen is seriously contaminated, use a soft cloth moistened with diluted neutral cleaner to clean the Display. Wring water out of the cloth before cleaning to prevent water from penetrating into the housing. Wipe the display with a dry cloth after cleaning.

4 Simple Troubleshooting:

If the display fails or the performance changes dramatically, check the Display in accordance with the following instructions. Remember to check the peripherals to pinpoint the source of the failure. If the Display still fails to perform as expected, contact the dealer for assistance.

(Continued on next page)

Symptom	Solution
Power cannot be turned on. (Power indicator does not light)	<ul style="list-style-type: none">- Check that both ends of the power cable are plugged into the socket appropriately.
No Input Signal message appears.	<ul style="list-style-type: none">- Check that the signal line is connected properly.- Check that the power of the relevant peripherals is turned on.- Check that the Input option that has been selected matches with the input signal.
The remote control does not function properly.	<ul style="list-style-type: none">- Check that the polarity of the batteries are correct.- Check that the batteries are not drained. (Use new batteries.)- Check that the Remote Control is within the operating range.- Check that the Remote Control is pointed to the Remote Control Window on the Display.- Check that there are no obstacles between the Remote Control and the Remote Control Window.- For more information about the Remote Control, refer to Chapter 6.
Flashing spots or stripes appear on the screen.	<ul style="list-style-type: none">- Check that there is no emitter sources (Car, HV cable or Neon lamp) or other possible interference sources.
Image color or quality deteriorates.	<ul style="list-style-type: none">- Check that all the video settings are adjusted appropriately, such as brightness, contrast, color etc.- For more information about video settings, refer to OSD Functions in Chapter 6.
Screen position and size are incorrect.	<ul style="list-style-type: none">- Check that the screen position and size is adjusted appropriately.
Image or color is incorrect.	<ul style="list-style-type: none">- Check that the signal line is connected properly.- When connecting to PC, you can change the resolution of PC to acquire correct image. The discrepancy of the PC output signal may affect the display of the image.
The external speaker has no sound.	<ul style="list-style-type: none">- Check that the speaker cables are connected appropriately.- Check that the Display is not in the Mute mode.- Check that the audio signal lines from the peripherals are connected properly.
Check that the input signal line is properly fixed, or display "Main no support"	<ul style="list-style-type: none">- Select the correct input signal.- For more information, refer to Support the Signal Mode in Chapter 8.

AKAI