



LCD TV | PLASMA TV OWNER'S MANUAL

LCD TV MODELS

32LG30 37LG50
37LG30 42LG50
42LG30 47LG50

52LG50

32LG60 32LG70
37LG60 42LG70
42LG60 47LG70
47LG60 52LG70
52LG60

PLASMA TV MODELS

42PG25
50PG25

50PG60
60PG60

Please read this manual carefully before operating your set.

Retain it for future reference.

Record model number and serial number of the set.

See the label attached on the back cover and quote this information to your dealer when you require service.

ENERGY STAR is a set of power-saving guidelines issued by the U.S. Environmental Protection Agency(EPA).



As an ENERGY STAR Partner LGE U. S. A., Inc. has determined that this product meets the ENERGY STAR guidelines for energy efficiency.

An extended owner's manual that contains information on the advanced features of these LG TV sets is located on the CD-ROM provided in an electronic version.

To read these files, you will need to use personal computer (PC) equipped with a CD-ROM drive.

P/NO : MFL34797048 (0803-REV04)
Printed in Korea

WARNING / CAUTION

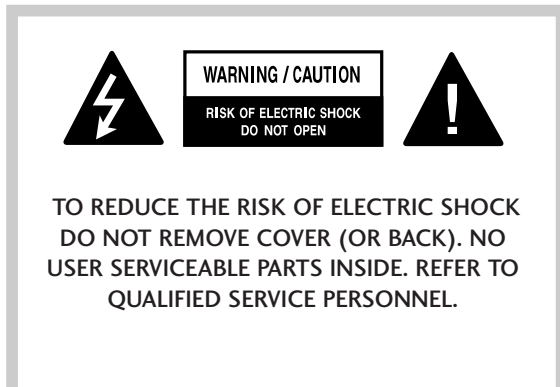

 The lightning flash with arrowhead symbol, within an equilateral triangle, is intended to alert the user to the presence of uninsulated “dangerous voltage” within the product’s enclosure that may be of sufficient magnitude to constitute a risk of electric shock to persons.

 The exclamation point within an equilateral triangle is intended to alert the user to the presence of important operating and maintenance (servicing) instructions in the literature accompanying the appliance.

WARNING/CAUTION

TO REDUCE THE RISK OF FIRE AND ELECTRIC SHOCK, DO NOT EXPOSE THIS PRODUCT TO RAIN OR MOISTURE.

NOTE TO CABLE/TV INSTALLER

This reminder is provided to call the CATV system installer’s attention to Article 820-40 of the National Electric Code (U.S.A.). The code provides guidelines for proper grounding and, in particular, specifies that the cable ground shall be connected to the grounding system of the building, as close to the point of the cable entry as practical.

WARNING / CAUTION

To prevent fire or shock hazards, do not expose this product to rain or moisture.

FCC NOTICE

Class B digital device

This equipment has been tested and found to comply with the limits for a Class B digital device, pursuant to Part 15 of the FCC Rules. These limits are designed to provide reasonable protection against harmful interference in a residential installation. This equipment generates, uses and can radiate radio frequency energy and, if not installed and used in accordance with the instructions, may cause harmful interference to radio communications. However, there is no guarantee that interference will not occur in a particular installation. If this equipment does cause harmful interference to radio or television reception, which can be determined by turning the equipment off and on, the user is encouraged to try to correct the interference by one or more of the following measures:

- Reorient or relocate the receiving antenna.
- Increase the separation between the equipment and receiver.
- Connect the equipment to an outlet on a circuit different from that to which the receiver is connected.
- Consult the dealer or an experienced radio/TV technician for help.

Any changes or modifications not expressly approved by the party responsible for compliance could void the user’s authority to operate the equipment.

CAUTION

Do not attempt to modify this product in any way without written authorization from LG Electronics. Unauthorized modification could void the user’s authority to operate this product

SAFETY INSTRUCTIONS

IMPORTANT SAFETY INSTRUCTIONS

Important safety instructions shall be provided with each apparatus. This information shall be given in a separate booklet or sheet, or be located before any operating instructions in an instruction for installation for use and supplied with the apparatus.

This information shall be given in a language acceptable to the country where the apparatus is intended to be used. The important safety instructions shall be entitled "Important Safety Instructions". The following safety instructions shall be included where applicable, and, when used, shall be verbatim as follows. Additional safety information may be included by adding statements after the end of the following safety instruction list. At the manufacturer's option, a picture or drawing that illustrates the intent of a specific safety instruction may be placed immediately adjacent to that safety instruction:

Read these instructions.

Keep these instructions.

Heed all warnings.

Follow all instructions.



- 1** Do not use this apparatus near water.



- 2** Clean only with dry cloth.



- 3** Do not block any ventilation openings. Install in accordance with the manufacturer's instructions.



- 4** Do not install near any heat sources such as radiators, heat registers, stoves, or other apparatus (including amplifiers) that produce heat.



- 5** When mounting a TV it on the wall, make sure not to install TV by hanging power and signal cables on the back of the TV.

- 6** Do not defeat the safety purpose of the polarized or grounding-type plug. A polarized plug has two blades with one wider than the other. A grounding type plug has two blades and a third grounding prong. The wide blade or the third prong are provided for your safety. If the provided plug does not fit into your outlet, consult an electrician for replacement of the obsolete outlet.



- 7** Protect the power cord from being walked on or pinched particularly at plugs, convenience receptacles, and the point where they exit from the apparatus.



- 8** Only use attachments/accessories specified by the manufacturer.



- 9** Unplug this apparatus when unused for long periods of time.



SAFETY INSTRUCTIONS

- 10** Use only with the cart, stand, tripod, bracket, or table specified by the manufacturer, or sold with the apparatus. When a cart is used, use caution when moving the cart/apparatus combination to avoid injury from tip-over.



- 11** Never touch this apparatus or antenna during a thunder or lightning storm.

- 12** Do not allow an impact shock or any objects to fall into the product, and do not drop onto the screen with something.

- 13** Refer all servicing to qualified service personnel. Servicing is required when the apparatus has been damaged in any way, such as power-supply cord or plug is damaged, liquid has been spilled or objects have fallen into the apparatus, the apparatus has been exposed to rain or moisture, does not operate normally, or has been dropped.



- 14** **CAUTION** concerning the Power Cord : Most appliances recommend they be placed upon a dedicated circuit; that is, a single outlet circuit which powers only that appliance and has no additional outlets or branch circuits. Check the specification page of this owner's manual to be certain.

Do not overload wall outlets. Overloaded wall outlets, loose or damaged wall outlets, extension cords, frayed power cords, or damaged or cracked wire insulation are dangerous. Any of these conditions could result in electric shock or fire. Periodically examine the cord of your appliance, and if its appearance indicates damage or deterioration, unplug it, discontinue use of the appliance, and have the cord replaced with an exact replacement part by an authorized servicer. Protect the power cord from physical or mechanical abuse, such as being twisted, kinked, pinched, closed in a door, or walked upon. Pay particular attention to plugs, wall outlets, and the point where the cord exits the appliance.



- 15** **Outdoor use marking :**
WARNING - To reduce the risk of fire or electric shock, do not expose this appliance to rain or moisture.



- 16** **Wet Location Marking :** Apparatus shall not be exposed to dripping or splashing and no objects filled with liquids, such as vases, shall be placed on or over apparatus.



17 GROUNDING

Ensure that you connect the earth ground wire to prevent possible electric shock. If grounding methods are not possible, have a qualified electrician install a separate circuit breaker.

Do not try to ground the unit by connecting it to telephone wires, lightning rods, or gas pipes.

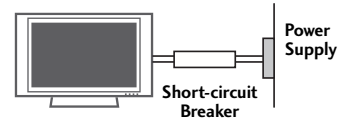

- 18** **DISCONNECTING DEVICE FROM MAINS**
 Mains plug is the disconnecting device. The plug must remain readily operable.

FOR LCD TV

- If the TV feels cold to the touch, there may be a small "flicker" when it is turned on. This is normal, there is nothing wrong with TV.
- Some minute dot defects may be visible on the screen, appearing as tiny red, green, or blue spots. However, they have no adverse effect on the monitor's performance.
- Avoid touching the LCD screen or holding your finger(s) against it for long periods of time. Doing so may produce some temporary distortion effects on the screen.

On Disposal

The fluorescent lamp used in this product contains a small amount of mercury. Do not dispose of this product with general household waste. Disposal of this product must be carried out in accordance to the regulations of your local authority.

CONTENTS

WARNING / CAUTION 2

SAFETY INSTRUCTIONS 3

PREPARATION

Accessories 6

Front Panel Information 7

Back Panel Information 8

Remote Control Functions 10

Stand Installation 12

Cable Management 14

Desktop Pedestal Installation 16

Swivel Stand 16

Attaching the TV to a Desk 16

VESA Wall Mounting 17

Protection Cover 18

Securing the TV to the Wall to prevent falling ... 19

Antenna or Cable Connection 20

EXTERNAL EQUIPMENT SETUP

HD Receiver Setup 21

DVD Setup 22

VCR Setup 23

PC Setup 24

WATCHING TV

Turning On TV 26

Channel Setup 26

Quick Menu 27

On-Screen Menus Selection 27

USB

Entry Modes 30

Photo List 31

Music List 33

APPENDIX

Troubleshooting 35

Maintenance 36

Product Specifications 37

Open Source Software Notice 39

HOW TO USE THE OWNER'S MANUAL ON THE CD-ROM

To view the Owner's Manual on the CD-ROM, Adobe Acrobat Reader must be installed on your PC. The "ACRORD" folder on the CD-ROM contains the installation programs for them. If you want to install those programs, Open the "My Computer" → Open the "LG" → Open the "ACRORD" → double-click your language.

TO VIEW THE OWNER'S MANUAL ON THE CD-ROM

The Owner's Manual files are included in the supplied CD-ROM. Load the supplied CD-ROM into the CD-ROM drive of your PC. After a while, the web page of the CD-ROM will open automatically. (for Window only)

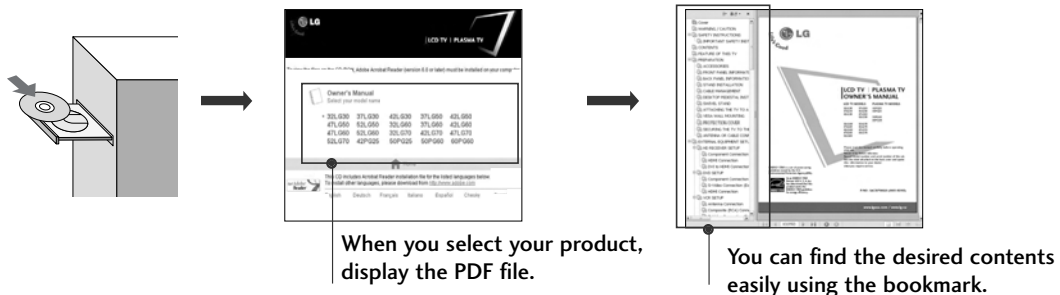

NOTE

▶ If the web page does not appear automatically, open the Owner's Manual file directly. Open the "My computer" → Open the "LG" → Open the "index.htm" file.

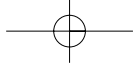

PREPARATION

ACCESSORIES

Ensure that the following accessories are included with your TV. If an accessory is missing, please contact the dealer where you purchased the product.

The accessories included may differ from the images below.

For further information, see the the Owner's Manual files supplied CD-ROM.

PREPARATION

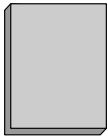

Owner's Manual



CD Manual
(Refer to p.5)

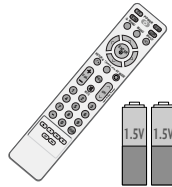

Remote Control,
Batteries

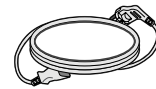

Power Cord

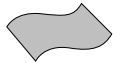

Polishing Cloth
(This feature is not available
for all models.)

- * Wipe spots on the exterior only with the polishing cloth.
- * Do not wipe roughly when removing stain. Please be cautions of that excessive pressure may cause scratch or discoloration.

Option Extras

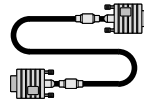

D-sub 15 pin Cable

When using the VGA (D-sub 15 pin cable) PC connection, the user must use shielded signal interface cables with ferrite cores to maintain standards compliance.

For Plasma TV models



x 4

Bolts for stand assembly
(Refer to P.12)
(Only 42PG25)



Cable Holder
(Only 42PG25)



Cable Management Clip

(Only 50PG25,
50/60PG60)



Protection Cover
(Refer to P.18)

For LCD TV models

32/37/42LG30, 37/42/47/52LG50, 32/42/47/52LG70

(Only 32/37/42LG30, 37/42LG50,
32/42LG70)

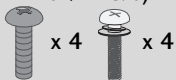

x 4 x 4

Bolts for stand assembly
(Refer to P.12)

(Only 32LG30/70)



Screw for stand fixing
(Refer to P.16)

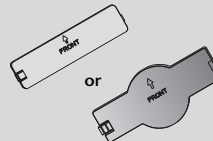

Protection Cover
(Refer to P.18)

32/37/42/47/52LG60

(Only 32/37LG60)



32LG60: 3EA 4EA
37LG60: 4EA

Bolts for stand assembly
(Refer to P.13)

(Only 42LG60)



2EA 1EA 4EA
(M4x16) (M4x20)



or



Protection Cover
(Refer to P.18)



**Cable Management
Clip**

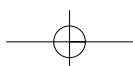

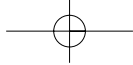

FRONT PANEL INFORMATION

- Image shown may differ from your TV.
- NOTE:** If your TV has a protection tape attached, remove the tape. And then wipe the TV with a cloth (If a polishing cloth is included with your TV, use it).

Plasma TV Models

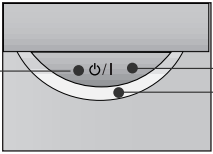

Remote Control Sensor

POWER Button

Power/Standby Indicator
Illuminates red in standby mode.
Illuminates blue when the TV is switched on.



INPUT MENU ENTER - VOL +

INPUT Button MENU Button ENTER Button VOLUME (-, +) Buttons CHANNEL (▼,▲) Buttons

32/37/42LG30, 37/42/47/52LG50, 32/42/47/52LG70

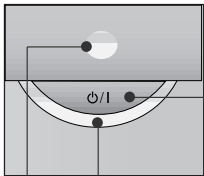

Remote Control Sensor

POWER Button

Power/Standby Indicator
Illuminates red in standby mode.
Illuminates blue when the TV is switched on.
(Can be adjusted using **Power Indicator** in the OPTION menu.)

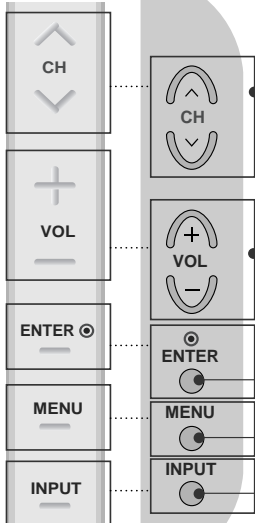

CH

CHANNEL (^, v) Buttons

VOL

VOLUME (+, -) Buttons

ENTER

ENTER Button

MENU

MENU Button

INPUT

INPUT Button

32/37/42/47/52LG60

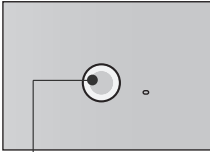

POWER Button

Remote Control Sensor

Power/Standby Indicator
Illuminates red in standby mode.
Illuminates white when the TV is switched on.
(Can be adjusted using **Power Indicator** in the OPTION menu.)

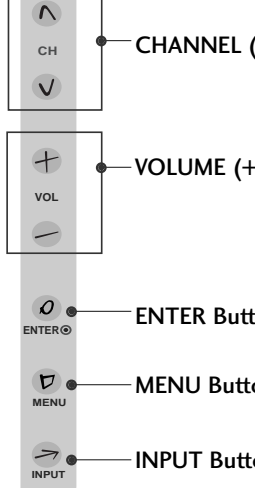

CH

CHANNEL (^, v) Buttons

VOL

VOLUME (+, -) Buttons

ENTER

ENTER Button

MENU

MENU Button

INPUT

INPUT Button

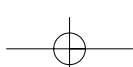

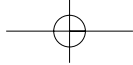

PREPARATION

PREPARATION

BACK PANEL INFORMATION

Image shown may differ from your TV

Plasma TV Models

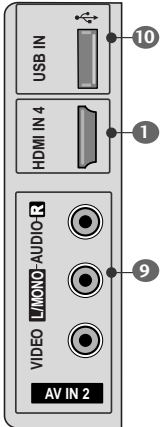
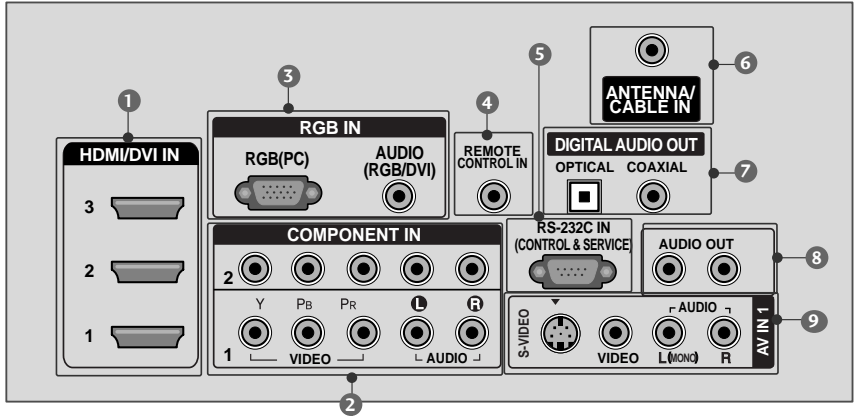

LCD TV Models

32/37/42LG30

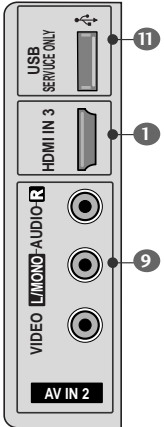
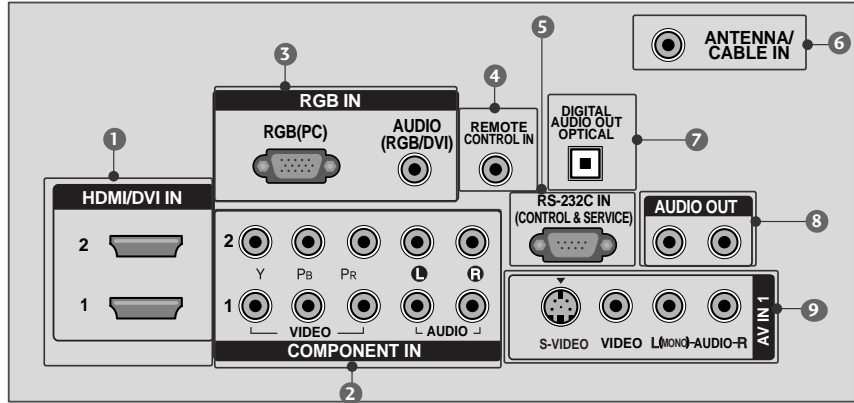

37/42/47/52LG50

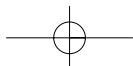
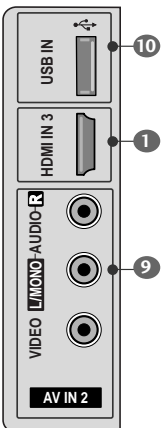
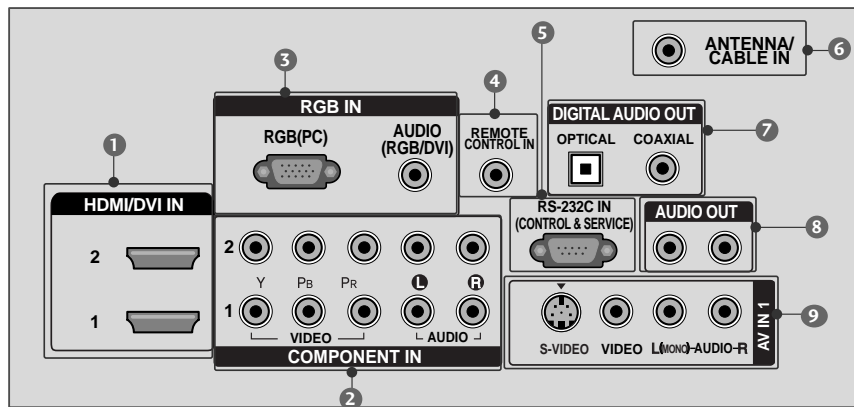

32/42/47/52LG70

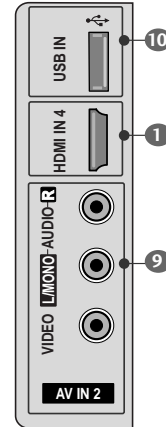
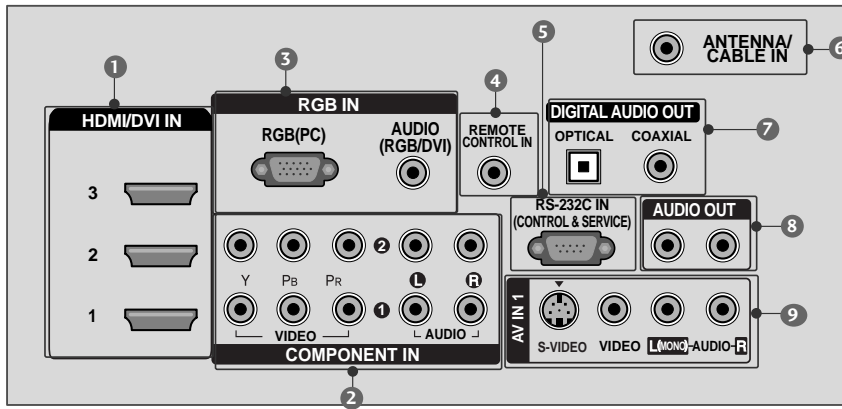

PREPARATION

32/37/42/47/52LG60

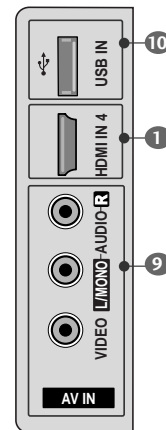
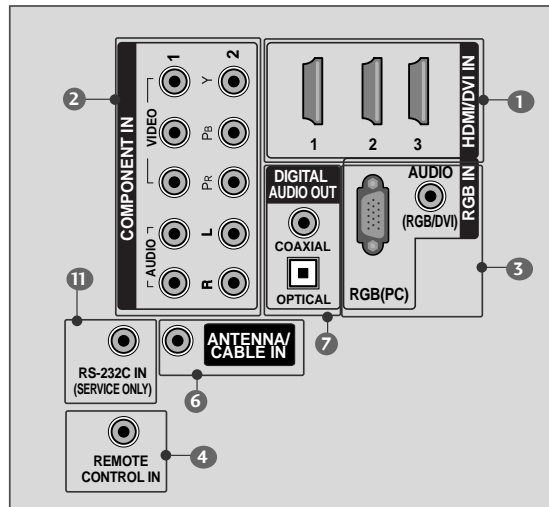

- 1 HDMI/DVI IN, HDMI IN**
Digital Connection. Supports HD video and Digital audio. Doesn't support 480i.
Accepts DVI video using an adapter or HDMI to DVI cable (not included)
 - 2 COMPONENT IN**
Analog Connection. Supports HD.
Uses a red, green, and blue cable for video & red and white for audio.
 - 3 RGB (PC)**
Analog PC Connection. Uses a D-sub 15 pin cable (VGA cable).
AUDIO (RGB/DVI)
1/8" headphone jack for analog PC audio input.
 - 4 REMOTE CONTROL PORT**
For a wired remote control.
 - 5 RS-232C IN (CONTROL & SERVICE) PORT**
Used by third party devices.
 - 6 ANTENNA/CABLE IN**
Connect over-the air signals to this jack.
Connect cable signals to this jack.
 - 7 DIGITAL AUDIO OUT**
Digital audio output for use with amps and home theater systems.
Includes an optical and/or coaxial connection.
Note: In standby mode, these ports do not work.
 - 8 AUDIO OUT**
Analog audio output for use with amps and home theater systems.
 - 9 AV (Audio/Video) IN**
Analog composite connection. Supports standard definition video only (480i).
S-VIDEO
Better quality than standard composition. Supports standard definition video only (480i).
 - 10 USB INPUT**
Used for viewing photos and listening to MP3s.
 - 11 USB SERVICE ONLY or RS-232C IN (SERVICE ONLY)**
Used for software updates.
-
- Power Cord Socket**
For operation with AC power.
Caution: Never attempt to operate the TV on DC power.

PREPARATION

REMOTE CONTROL FUNCTIONS

When using the remote control, aim it at the remote control sensor on the TV.

PREPARATION

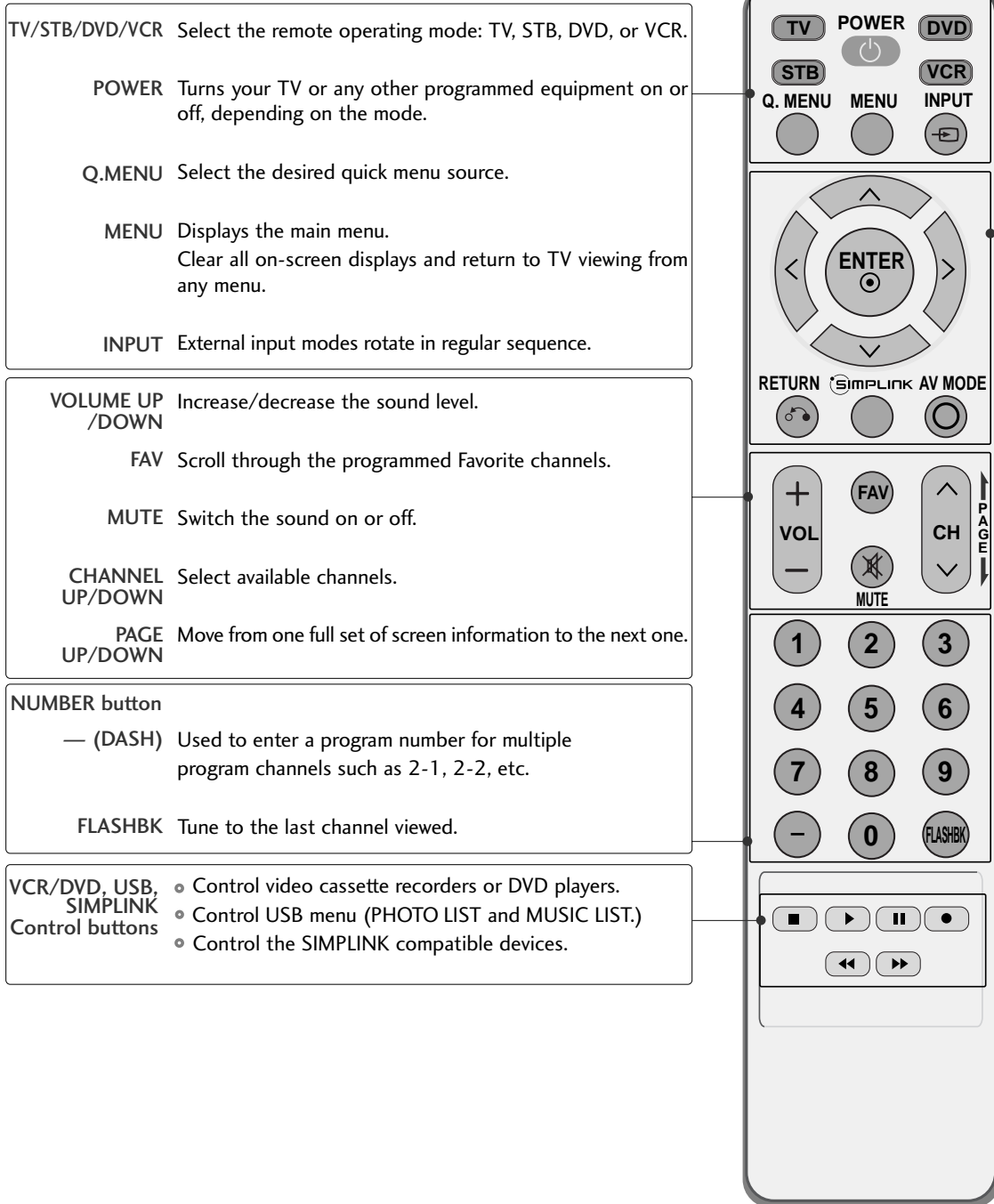

THUMBSTICK (Up/Down/Left Right/ENTER) Navigate the on-screen menus and adjust the system settings to your preference.

RETURN Allows the user to move return one step in an interactive application or other user interaction function.

SIMPLINK See a list of AV devices connected to TV.
When you toggle this button, the SIMPLINK menu appears at the screen.

AV MODE It helps you select and set images and sounds.

Installing Batteries

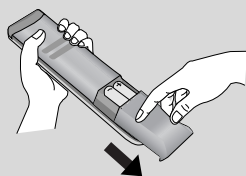

- Open the battery compartment cover on the back side and install the batteries matching correct polarity (+with +,-with -).
- Install two 1.5V AAA batteries. Don't mix old or used batteries with new ones.
- Close cover.

PREPARATION

STAND INSTALLATION

■ Image shown may differ from your TV

PREPARATION

Only 42PG25

- 1 Carefully place the TV screen side down on a cushioned surface to protect the screen from damage.

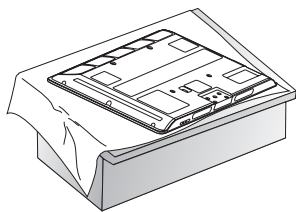

- 2 Assemble the TV as shown.

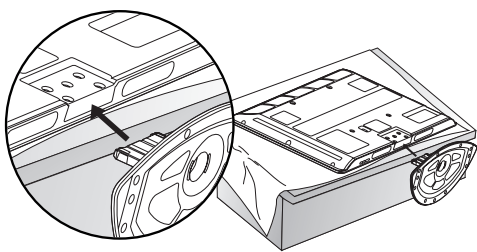

- 3 Fix the 4 bolts securely using the holes in the back of the TV.

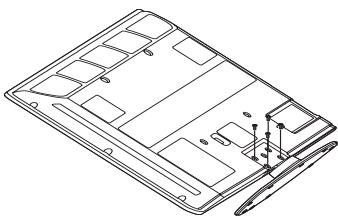

Only 32/37/42LG30, 37/42LG50, 32/42LG70

- 1 Carefully place the TV screen side down on a cushioned surface to protect the screen from damage.

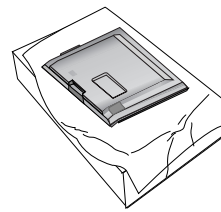

- 2 Assemble the parts of the **STAND BODY** with **COVER BASE** of the TV.

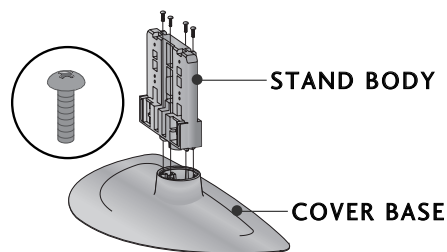

- 3 Assemble the TV as shown.

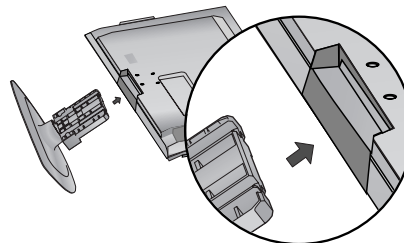

- 4 Fix the 4 bolts securely using the holes in the back of the TV.

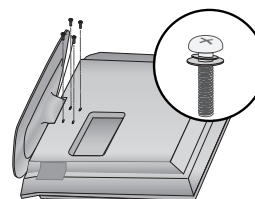

Only 32/37/42LG60

- 1 Carefully place the TV screen side down on a cushioned surface to protect the screen from damage.

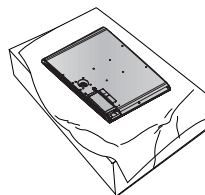

- 2 Assemble the parts of the **STAND BODY** with **COVER BASE** of the TV.

32LG60

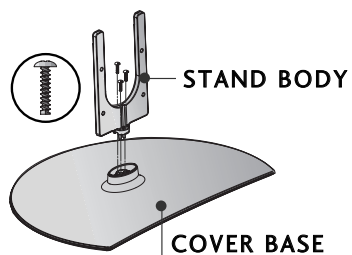

37LG60

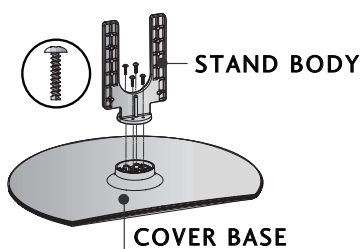

42LG60

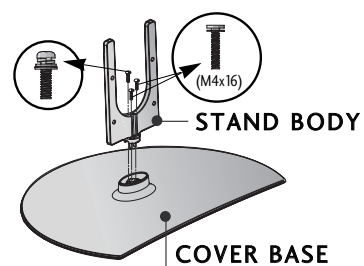

- 3 Assemble the TV as shown.

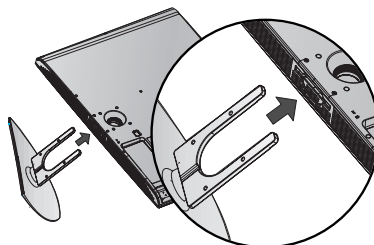

- 4 Fix the 4 bolts securely using the holes in the back of the TV.

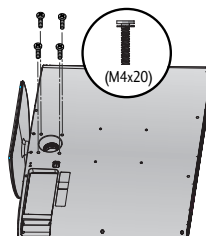

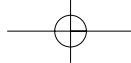

PREPARATION

CABLE MANAGEMENT

- Here shown may be somewhat different from your TV.

Plasma TV Model

- Connect the cables as necessary.
To connect additional equipment, see the **EXTERNAL EQUIPMENT SETUP** section.

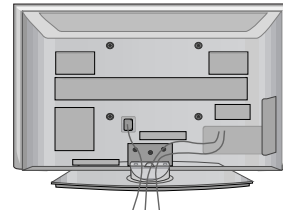

- Install the **CABLE MANAGEMENT CLIP** as shown.
If your TV has the **CABLE HOLDER**, install it as shown and bundle the cables.

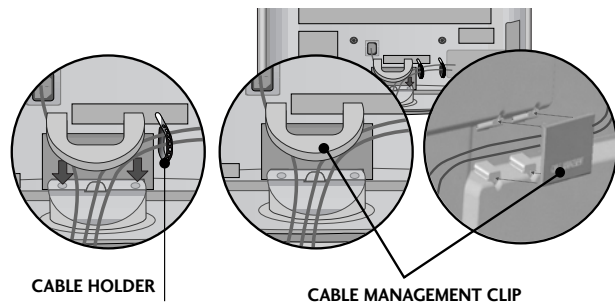

CABLE HOLDER

CABLE MANAGEMENT CLIP

How to remove the CABLE MANAGEMENT CLIP

42PG25

- First, press the cable management. Hold the **CABLE MANAGEMENT CLIP** with both hands and pull it upward.

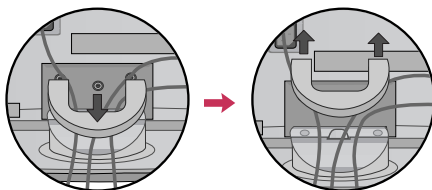

50PG25, 50/60PG60

- Hold the **CABLE MANAGEMENT CLIP** with both hands and pull it upward.
- Separate **CABLE MANAGEMENT CLIP** from TV by pressing two latches.

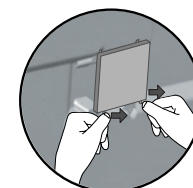
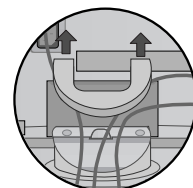

! NOTE

- Do not hold the **CABLE MANAGEMENT CLIP** when moving the TV.
- If the TV is dropped, you may be injured or the product may be broken.

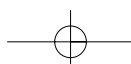

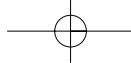

LCD TV Model

**32/37/42LG30, 37/42/47/52LG50,
32/42/47/52LG70**

- 1 Connect the cables as necessary.
To connect additional equipment, see the **EXTERNAL EQUIPMENT SETUP** section.

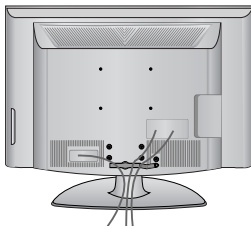

- 2 Install the **CABLE MANAGEMENT CLIP** as shown.

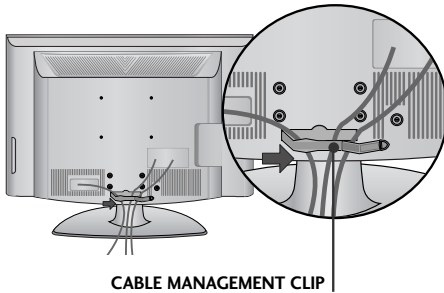

- 3 Put the cables inside the **CABLE MANAGEMENT CLIP** and snap it closed.

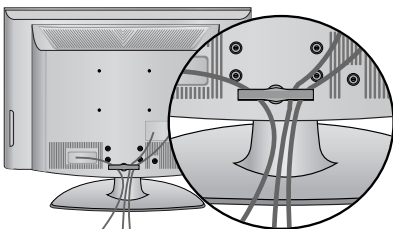

32/37/42/47/52LG60

- 1 Align the hole with the tab on the **CABLE MANAGEMENT CLIP**.

Turn the **CABLE MANAGEMENT CLIP** as shown.

Note: This cable management can be broken by excessive pressure.

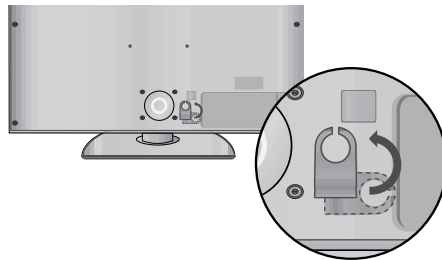
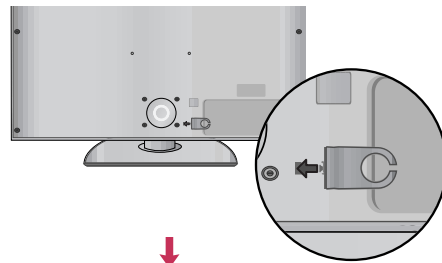

- 2 Connect the cables as necessary.
To connect additional equipment, see the **EXTERNAL EQUIPMENT SETUP** section.

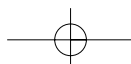
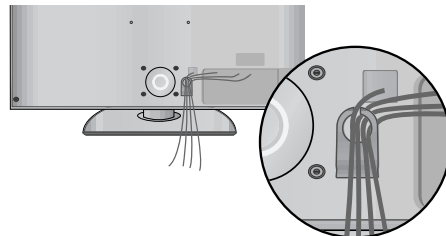

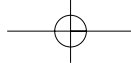

PREPARATION

DESKTOP PEDESTAL INSTALLATION

- Image shown may differ from your TV.

For proper ventilation, allow a clearance of 4 inches on all four sides from the wall.

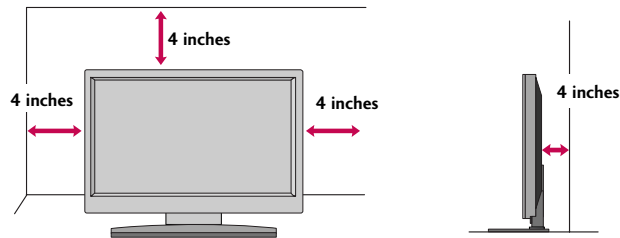

CAUTION ▶ Ensure adequate ventilation by following the clearance recommendations.

SWIVEL STAND

After installing the TV, you can adjust the TV set manually to the left or right direction by 20 degrees to suit your viewing position.

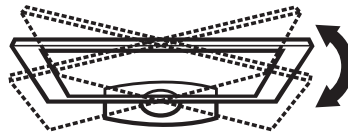

ATTACHING THE TV TO A DESK (Only 32LG30/70)

The TV must be attached to a desk so it cannot be pulled in a forward/backward direction, potentially causing injury or damaging the product.

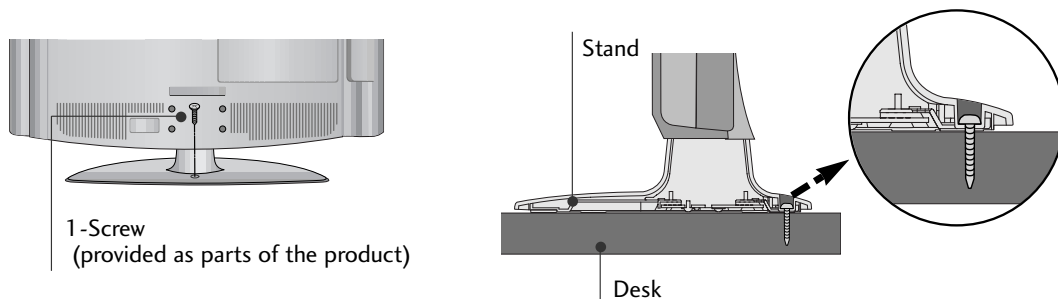

WARNING

- ▶ To prevent TV from falling over, the TV should be securely attached to the floor/wall per installation instructions. Tipping, shaking, or rocking the machine may cause injury.

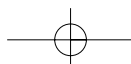

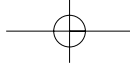

VESA WALL MOUNTING

This TV accepts VESA FDMI compliant mounts via the four screw holes on the back of the TV. We recommend that you use a wall mounting bracket of LG brand when mounting the TV to a wall.

Plasma TV Models

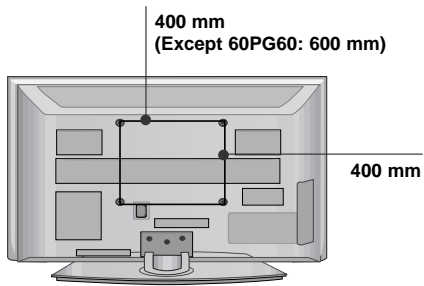

LCD TV Models

32/37/42LG30, 37/42/47/52LG50,
32/42/47/52LG70

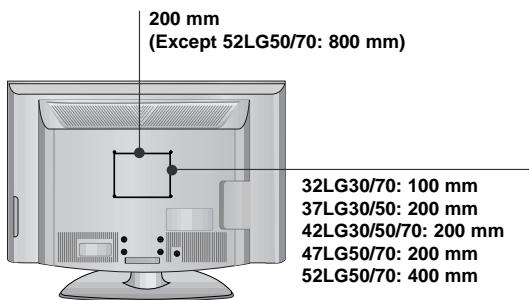

32/37/42/47/52LG60

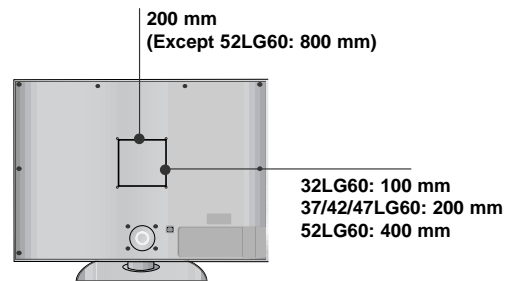

NOTE

- ▶ Screw length needed depends on the wall mount used. For further information, refer to the instructions included with the mount.

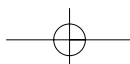

PREPARATION

PROTECTION COVER

- Image shown may differ from your TV.

You can remove the stand before installing the TV on a wall mount by performing the previous stand instructions in reverse. After removing the stand, install the included **protection cover** over the hole for the stand.

Insert the **PROTECTION COVER** into the TV until clicking sound.

Plasma TV Models

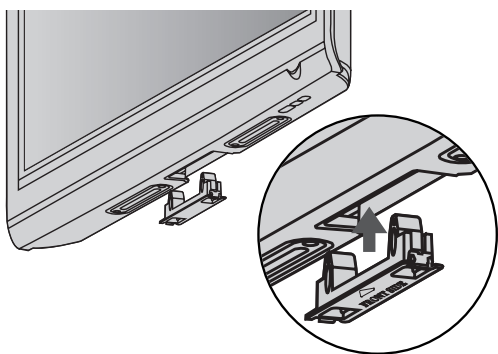

LCD TV Models

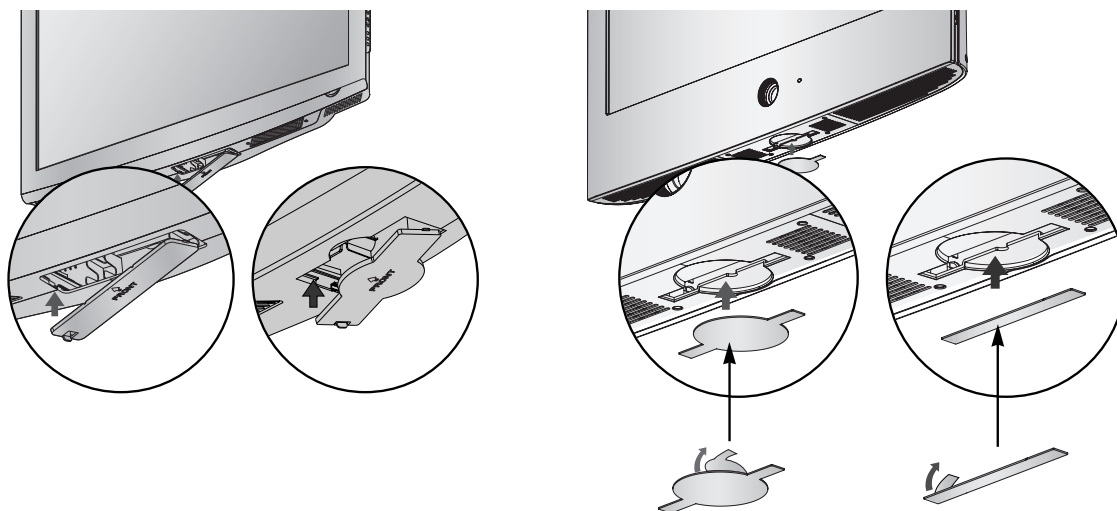

After removing the protection paper from the protection cover, adhere it to the TV as shown.

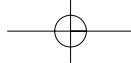

SECURING THE TV TO THE WALL TO PREVENT FALLING

- You should purchase necessary components to prevent TV from falling off of the stand.
- Image shown may differ from your TV.

We recommend that you set up the TV close to a wall so it cannot fall over if pushed backwards. Additionally, we recommend that the TV be attached to a wall so it cannot be pulled in a forward direction, potentially causing injury or damaging the product.

Caution: Please make sure that children don't climb on or hang from the TV.

PREPARATION

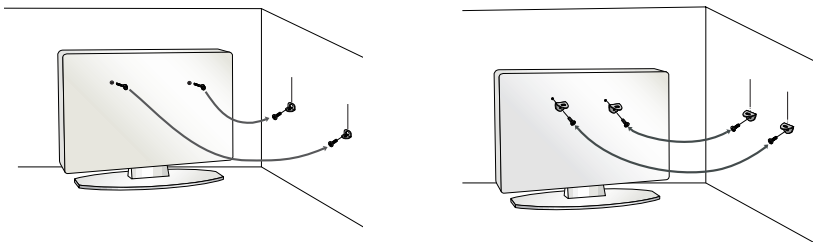

- Insert the eye-bolts (or TV brackets and bolts) to tighten the product to the wall as shown in the picture.
 - * If your product has the bolts in the eye-bolts position before inserting the eye-bolts, loosen the bolts.
 - * Insert the eye-bolts or TV brackets/bolts and tighten them securely in the upper holes.
- Secure the wall brackets with the bolts (not provided as parts of the product, must purchase separately) to the wall. Match the height of the bracket that is mounted on the wall to the holes in the product.
- Ensure the eye-bolts or brackets are tightened securely.

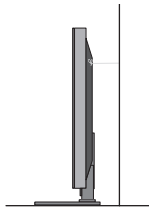

- Use a sturdy rope (not provided as parts of the product, must purchase separately) to tie the product. It is safer to tie the rope so it becomes horizontal between the wall and the product.

! NOTE

- ▶ Use a platform or cabinet strong enough and large enough to support the size and weight of the TV.
- ▶ To use the TV safely make sure that the height of the bracket on the wall and the one on the TV are the same.

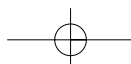

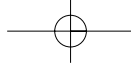

PREPARATION

- To prevent damage do not connect to the power outlet until all connections are made between the devices.

ANTENNA OR CABLE CONNECTION

PREPARATION

1. Antenna (Analog or Digital)

Wall Antenna Socket or Outdoor Antenna without a Cable Box Connection.

For optimum picture quality, adjust antenna direction if needed.

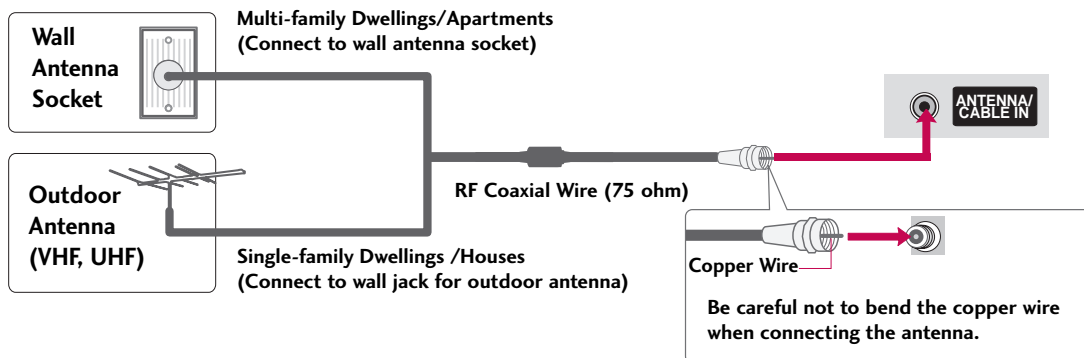

2. Cable

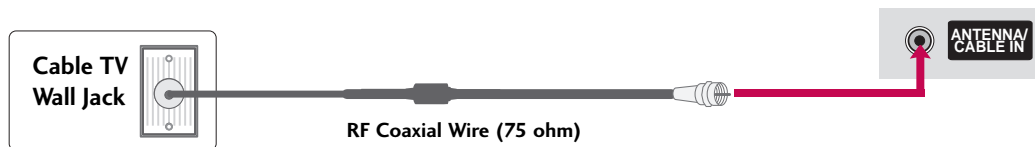

- To improve the picture quality in a poor signal area, please purchase a signal amplifier and install properly.
- If the antenna needs to be split for two TV's, install a 2-Way Signal Splitter.
- If the antenna is not installed properly, contact your dealer for assistance.

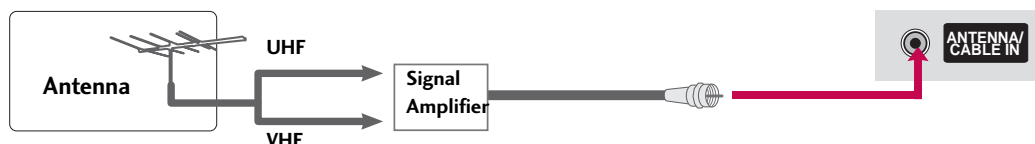

NOTE ▶ The TV will let you know when the analog, cable, and digital channel scans are complete.

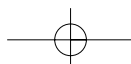

EXTERNAL EQUIPMENT SETUP

- To prevent the equipment damage, never plug in any power cords until you have finished connecting all equipment.
- This part of EXTERNAL EQUIPMENT SETUP mainly use picture for 37/42/47/52LG50.

HD RECEIVER SETUP

This TV can receive Digital Over-the-air/Cable signals without an external digital set-top box. However, if you do receive digital signals from a digital set-top box or other digital external device, refer to the figure as shown below.

Component Connection

1. How to connect

- 1 Connect the video outputs (Y, PB, PR) of the digital set-top box to the **COMPONENT IN VIDEO 1** jacks on the TV. Match the jack colors (Y = green, PB = blue, and PR = red).
- 2 Connect the audio output of the digital set-top box to the **COMPONENT IN AUDIO 1** jacks on the TV.

2. How to use

- Turn on the digital set-top box.
(Refer to the owner's manual for the digital set-top box operation)
- Select the **Component 1** input source on the TV using the **INPUT** button on the remote control.
- If connected to **COMPONENT IN2** input, select the **Component 2** input source on the TV.

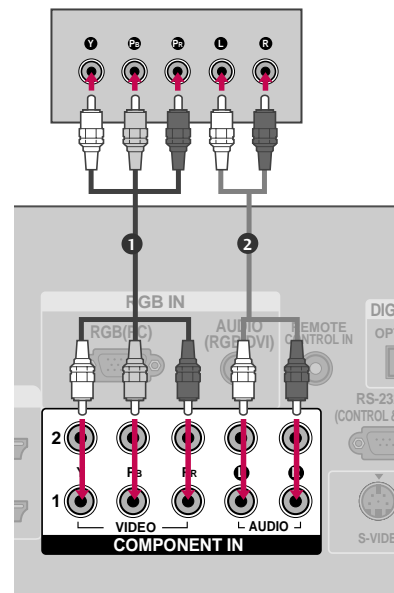

i.e) 37/42/47/52LG50

Supported Resolutions

Signal	Component	HDMI
480i	Yes	No
480p	Yes	Yes
720p	Yes	Yes
1080i	Yes	Yes
1080p	Yes	Yes

Y, CB/PB, CR/PR

Resolution	Horizontal Frequency(KHz)	Vertical Frequency(Hz)
720x480i	15.73	59.94
	15.73	60.00
720x480p	31.47	59.94
	31.50	60.00
1280x720p	44.96	59.94
	45.00	60.00
1920x1080i	33.72	59.94
	33.75	60.00
1920x1080p	26.97	23.976
	27.00	24.00
	33.71	29.97
	33.75	30.00
	67.432	59.94
	67.50	60.00

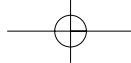

EXTERNAL EQUIPMENT SETUP

DVD SETUP

Component Connection

1. How to connect

- 1 Connect the video outputs (Y, Pb, Pr) of the DVD to the **COMPONENT IN VIDEO1** jacks on the TV.
Match the jack colors (Y = green, Pb = blue, and Pr = red).
- 2 Connect the audio outputs of the DVD to the **COMPONENT IN AUDIO1** jacks on the TV.

2. How to use

- Turn on the DVD player, insert a DVD.
- Select the **Component 1** input source on the TV using the **INPUT** button on the remote control.
- If connected to **COMPONENT IN 2** input, select the **Component 2** input source on the TV.
- Refer to the DVD player's manual for operating instructions.

i.e) 37/42/47/52LG50

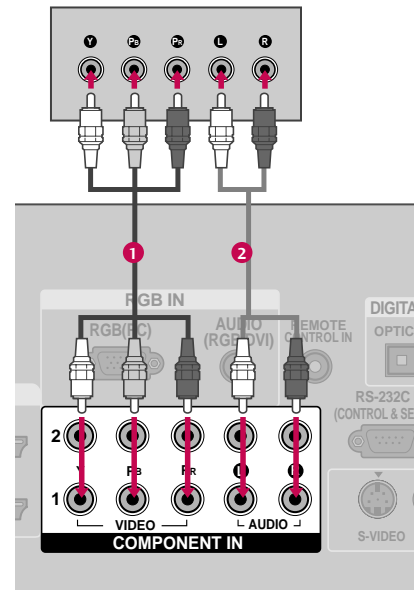

HDMI Connection

1. How to connect

- 1 Connect the HDMI output of the DVD to the **HDMI/DVI IN1, 2, 3** or **4** jack on the TV.
- 2 No separate audio connection is necessary.
HDMI supports both audio and video.

2. How to use

- Select the **HDMI1, HDMI2, HDMI3, or HDMI4** input source on the TV using the **INPUT** button on the remote control.
- Refer to the DVD player's manual for operating instructions.

i.e) 37/42/47/52LG50

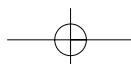
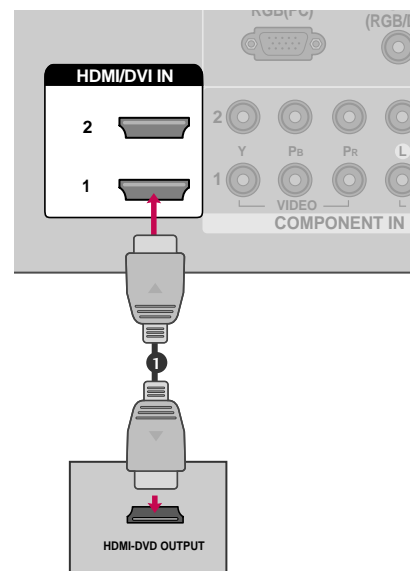

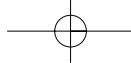

VCR SETUP

Composite (RCA) Connection

1. How to connect

- 1 Connect the **AUDIO/VIDEO** jacks between TV and VCR. Match the jack colors (Video = yellow, Audio Left = white, and Audio Right = red)

2. How to use

- Insert a video tape into the VCR and press PLAY on the VCR. (Refer to the VCR owner's manual.)
- Select the **AV1** input source on the TV using the **INPUT** button on the remote control.
- If connected to **AV IN2**, select **AV2** input source on the TV.

NOTE

- ▶ If you have a mono VCR, connect the audio cable from the VCR to the **AUDIO L/MONO** jack of the TV.

i.e) 37/42/47/52LG50

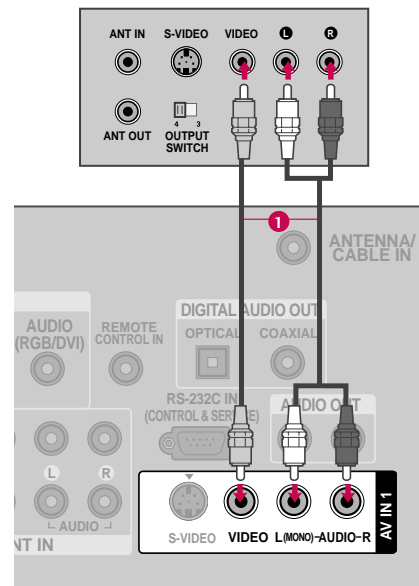

S-Video Connection (Except 32/37/42/47/52LG60)

1. How to connect

- 1 Connect the S-VIDEO output of the VCR to the **S-VIDEO** input on the TV.
- 2 Connect the audio outputs of the VCR to the **AUDIO** input jacks on the TV.

2. How to use

- Insert a video tape into the VCR and press PLAY on the VCR. (Refer to the VCR owner's manual.)
- Select the **AV1** input source on the TV using the **INPUT** button on the remote control.

NOTE

- ▶ S-Video provides better quality than composite. Use it when available.

CAUTION

- ▶ Do not connect to both Video and S-Video at the same time. In the event that you connect both Video and the S-Video cables, only the S-Video will work.

i.e) 37/42/47/52LG50

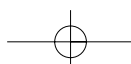
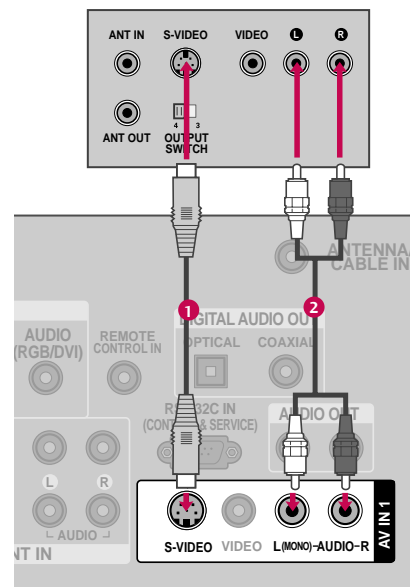

EXTERNAL EQUIPMENT SETUP

PC SETUP

VGA (D-Sub 15 pin) Connection

1. How to connect

- 1 Connect the VGA output of the PC to the **RGB (PC)** jack on the TV.
- 2 Connect the PC audio output to the **AUDIO (RGB/DVI)** jack on the TV.

2. How to use

- Turn on the PC and the TV.
- Select the **RGB-PC** input source on the TV using the **INPUT** button on the remote control.

i.e) 37/42/47/52LG50

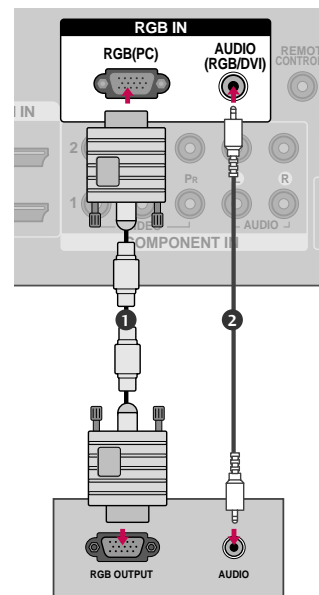

Supported Display Specifications (RGB-PC, HDMI-PC)

For 32/37/42LG30

Resolution	Horizontal Frequency(KHz)	Vertical Frequency(Hz)
640x350	31.469	70.08
720x400	31.469	70.08
640x480	31.469	59.94
800x600	37.879	60.31
1024x768	48.363	60.00
1280x768	47.776	59.87
1360x768	47.720	59.799
1366x768	47.130	59.65

* Only RGB-PC mode

For 37/42/47/52LG50, 32/37/42/47/52LG60,
32/42/47/52LG70

Resolution	Horizontal Frequency(KHz)	Vertical Frequency(Hz)
640x350	31.468	70.09
720x400	31.469	70.08
640x480	31.469	59.94
	37.500	75.00
800x600	37.861	72.80
	35.156	56.25
	37.879	60.31
	46.875	75.00
1024x768	48.077	72.18
	48.363	60.00
	56.476	70.06
	60.023	75.02
1280x768	47.776	59.87
	60.289	74.893
1280x1024	63.981	60.02
	79.976	75.025
1360x768	47.712	60.015
1600x1200	75.00	60.00
1920x1080	RGB-PC 66.587	59.934
	HDMI-PC 67.5	60.00

* Only RGB-PC mode

For 42/50PG25, 50/60PG60

Resolution	Horizontal Frequency(KHz)	Vertical Frequency(Hz)
640x350	31.468	70.09
720x400	31.469	70.08
640x480	31.469	59.94
	37.500	75.00
800x600	37.861	72.80
	35.156	56.25
	37.879	60.31
	46.875	75.00
1024x768	48.077	72.18
	48.363	60.00
	56.476	70.06
1280x768	60.023	75.02
	47.776	59.87
1280x1024	60.289	74.893
	63.981	60.02
1280x1024	79.976	75.025
	47.712	60.015
1360x768	47.712	60.015
1600x1200	75.00	60.00
1920x1080	66.587	59.934

* Only RGB-PC mode

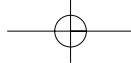

WATCHING TV

TURNING ON TV

- 1 First, connect power cord correctly.
At this moment, the TV switches to standby mode.
 - In standby mode to turn TV on, press the **⏻/I**, **INPUT**, (**▲▼** or **^ v**) button on the TV or press the **POWER**, **INPUT**, **CH**(**^** or **v**), **Number (0~9)** button on the remote control.
- 2 Select the viewing source by using the **INPUT** button on the remote control.
 - This TV is programmed to remember which power state it was last set to, even if the power cord is out.
- 3 When finished using the TV, press the **POWER** button on the remote control. The TV reverts to standby mode.

NOTE ▶ If you intend to be away on vacation, disconnect the power plug from the wall power outlet.

WATCHING TV

CHANNEL SETUP

Auto Scan (Auto Tuning)

Automatically finds all channels available through antenna or cable inputs, and stores them in memory on the channel list.

Run Auto Tuning again after any Antenna/Cable connection changes.

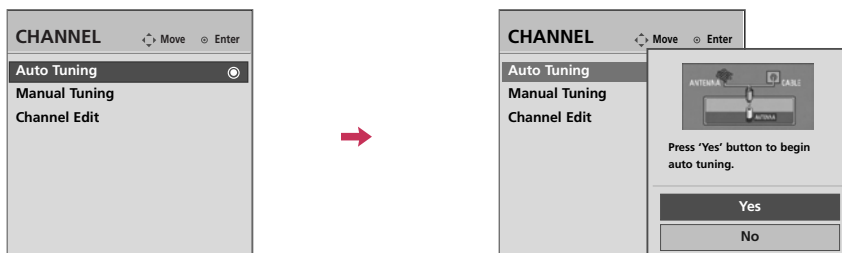

- 1 **MENU** Select **CHANNEL**.
- 2 **ENTER** Select **Auto Tuning**.
- 3 **ENTER** Select **Yes**.
- 4 **ENTER** Run **Auto tuning**.

- 5 **RETURN** Return to the previous menu.
- MENU** Return to TV viewing.

■ A password is required to gain access to Auto Tuning menu if the Lock System is turned on.

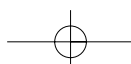

QUICK MENU

Q.Menu (Quick Menu) is a menu of features which users might use frequently.

Plasma TV

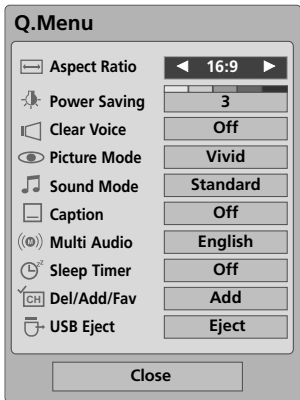

LCD TV

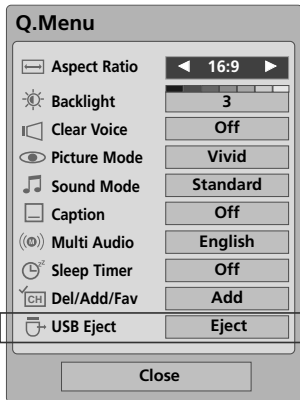

- 1 Display each menu.
- 2 Make appropriate adjustments.
- 3 Return to TV viewing.

Except 32/37/42LG30

WATCHING TV

ON-SCREEN MENU SELECTION

Your TV's OSD (On Screen Display) may differ slightly from that shown in this manual.

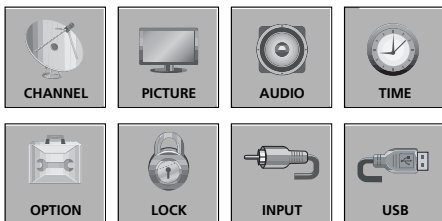

or

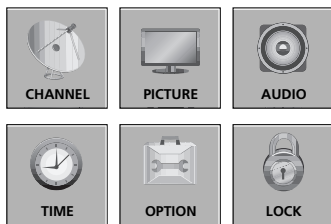

- 1 Display each menu.
- 2 Select a menu item.
- 3 Enter to the pop up menu.
- 4 Return to TV viewing.

CHANNEL

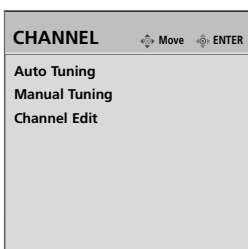

Auto Tuning	▪ All available TV channels are searched and stored automatically.
Manual Tuning	▪ User can do manual channel selection and add or delete individual channels.
Channel Edit	▪ You can add or delete in the channel list.

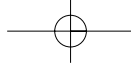

WATCHING TV

WATCHING TV

PICTURE

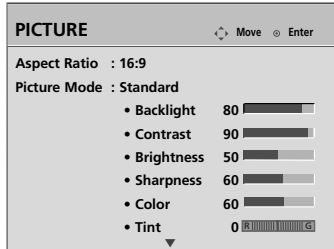

Aspect Ratio	<ul style="list-style-type: none"> Select the desired picture format: Set by program, 4:3, 16:9, Zoom1, Zoom2, Just Scan.
Picture Mode	<ul style="list-style-type: none"> Select the Intelligent Sensor (<i>Except 32/37/42LG30, Plasma TV</i>), Vivid, Standard, Cinema/ TRX Cinema (Only for 50/60PG60), Sport, Game, Expert1, Expert2. Adjust the Backlight (<i>Only LCD TV</i>), Contrast, Brightness, Sharpness, Color, Tint. Advanced Control: Adjust the Color Temperature, Fresh Contrast, Fresh Color, Noise Reduction, Gamma, Black Level, Eye Care (<i>Only LCD TV</i>), Real Cinema (<i>For LCD TV</i>) / Film Mode (<i>For Plasma TV</i>), TruMotion (Only 32/37/42/47/52LG60, 32/42/47/52LG70). Reset: Settings of the selected picture modes return to the default factory settings.
Screen (RGB-PC)	<ul style="list-style-type: none"> Adjust the screen Resolution, Auto config, Position, Size, Phase, Reset.
TruMotion Demo (32/37/42/47/52LG60, 32/42/47/52LG70 Only)	<ul style="list-style-type: none"> Use this feature to see the difference TruMotion makes.

AUDIO

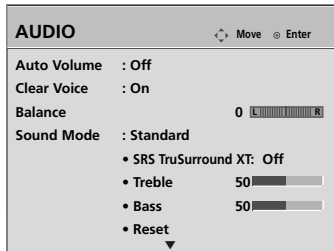

Auto Volume	<ul style="list-style-type: none"> Auto Volume makes sure that the volume level remains consistent whether you are watching a commercial or a regular TV program.
Clear Voice	<ul style="list-style-type: none"> By differentiating the human sound range from others, it helps users listen to human voices better.
Balance	<ul style="list-style-type: none"> Adjust the left/right sound of speaker.
Sound Mode	<ul style="list-style-type: none"> Select the Standard, Music, Cinema, Sport, and Game. SRS TruSurround XT, Treble, Bass: Adjust the sound to suit your taste and room situations. Reset: Settings of the selected Sound Mode return to the default factory settings.
TV Speaker	<ul style="list-style-type: none"> Turn the TV speaker On or off.

TIME

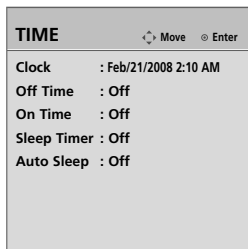

Clock	<ul style="list-style-type: none"> Auto: The time is set automatically from a digital channel signal. Select your viewing area time zone. Select Auto, Off, On depending on whether or not your viewing area observes Daylight Saving time. Manual: Set the clock manually.
Off Time	<ul style="list-style-type: none"> Select On or Off.
On Time	<ul style="list-style-type: none"> Select On or Off.
Sleep Timer	<ul style="list-style-type: none"> Select the amount of time before your TV turns off automatically: Off, 10, 20, 30, 60, 90, 120, 180, 240.
Auto Sleep	<ul style="list-style-type: none"> TV will be automatically turned off, in case of no signal for 10 minutes.

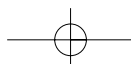

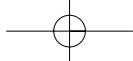

OPTION

OPTION	⏏ Move ⏎ Enter
Language	: English
Input Label	
SIMPLINK	: On
Key Lock	: Off
Caption	: Off
ISM Method	: Normal
Power Saving	: Level 0
Set ID	: 1

Language	■ Select your desired language for on screen menus : English, Spanish, French.
Input Label	■ Set a label to each input source.
SIMPLINK	■ Control and play other AV devices connected to the TV through HDMI cable without additional cables and settings.
key Lock	■ This feature can be used to prevent unauthorized viewing by locking out the front panel controls.
Caption	■ When selecting Off, Submenus for Analog, DTV, and Digital Option become disabled. ■ Analog: CC1~ CC4 , Text1~ Text4. ■ Digital: CC1~ CC4 , Text1~ Text4, Service1~ Service6. ■ Digital Option: Customize the DTV/CADTV captions that appear on your screen.
ISM Method (Plasma TV only)	■ Use it to minimize any fixed image on the screen. : Normal, Orbiter, Inversion, White Wash.
Power Saving (Plasma TV only)	■ Reduces the plasma display power consumption.
Set ID (Except 32/37/42/47/52LG60)	■ Choose the desired TV ID number.
Power Indicator (LCD TV only)	■ Adjust Power Indicator menu options.
Initial Setting	■ After turning on the TV, adjust Mode, Time, Language, Auto Tuning.

LOCK

LOCK	⏏ Move ⏎ Enter
Lock System	: Off
Set Password	
Block Channel	
Movie Rating	
TV Rating-Children	
TV Rating-General	
Downloadable Rating	
Input Block	

For USA

LOCK	⏏ Move ⏎ Enter
Lock System	: Off
Set Password	
Block Channel	
TV Rating-English	
TV Rating-French	
Downloadable Rating	
Input Block	

For Canada

Lock System	■ Select On or Off.
Set Password	■ Change the password.
Block Channel	■ Select a channel number that you wish to block.
Movie Rating	■ Blocks movies according to the movie ratings limits specified.
TV Rating-Children	■ Prevents children from watching certain children's TV programs, according to the ratings limit set.
TV Rating-General	■ Based on the ratings, blocks certain TV programs that you and your family do not want to view.
TV Rating-English	■ Selecting canadian english language rating system.
TV Rating-French	■ Selecting canadian french language rating system.
Downloadable Rating	■ This function may become available in the future and will be available only for digital channel signal.
Input Block	■ Enables you to select a source to block from the external source devices you have hooked up.

INPUT

INPUT	⏏ Move ⏎ Enter
Antenna	
Cable	
AV1	
AV2	
Component1	
Component2	
RGB-PC	
HDMI1	

Input
(Except 32/37/42LG30)

- Select desired input sources.
- Your TV's OSD (On Screen Display) may differ slightly from that shown in this manual.

USB

USB	⏏ Move ⏎ Enter
PHOTO LIST	
MUSIC LIST	

USB
(Except 32/37/42LG30)

- Use PHOTO LIST or MUSIC LIST.

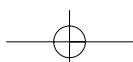

USB

* This feature is only for 37/42/47/52LG50, 32/37/42/47/52LG60, 32/42/47/52LG70, Plasma TV.

ENTRY MODES

When you connect a USB device, this screen is displayed automatically.

In USB device, you can not add a new folder or delete the existing folder.

- 1 Connect the USB device to the **USB IN** jacks on the side of TV.

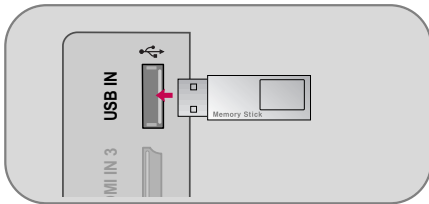

- 2 Select **PHOTO LIST** or **MUSIC LIST**.

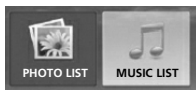

- 3

- It doesn't support USB HDD
- This TV supports JPG and MP3.

When removing the USB device

Select the **USB Eject** menu before removing the USB device.

- 1 Q. MENU Select **USB Eject**.

- 2
- 3

Precautions when using the USB device

- ▶ Only a USB storage device is recognizable.
- ▶ If the USB storage device is connected through a USB hub, the device is not recognizable.
- ▶ A USB storage device using an automatic recognition program may not be recognized.
- ▶ A USB storage device which uses its own driver may not be recognized.
- ▶ In case of a card reader, up to four memory cards are concurrently recognizable.
- ▶ The recognition speed of a USB storage device may depend on each device.
- ▶ Please do not turn off the TV or unplug the USB device when the connected USB storage device is working. When such device is suddenly separated or unplugged, the stored files or the USB storage device may be damaged.
- ▶ Please do not connect the USB storage device which was artificially maneuvered on the PC. The device may cause the product to malfunction or fail to be played. Never forget to use only a USB storage device which has normal music files or image files.
- ▶ Please use only a USB storage device which was formatted as a FAT or NTFS file system provided with the Windows operating system. In case of a storage device formatted as a different utility program which is not supported by Windows, it may not be recognized.
- ▶ Please connect power to a USB storage device which requires an external power supply. If not, the device may not be recognized.
- ▶ Please connect a USB storage device with cable is offered by USB maker. If connected with cable is not offered by USB maker or an excessively long cable, the device may not be recognized.
- ▶ Some USB storage devices may not be supported or operated smoothly.
- ▶ File alignment method of USB storage device is similar to Window XP and filename can recognize up to 100 English characters.
- ▶ Please backup important files because data on USB device may be damaged. Data management is consumer's responsibility and as a result, the manufacturer does not cover data damage.

PHOTO LIST

You can view .JPG files from USB storage devices.
 The On Screen Display on your model may be slightly different.

Screen Components

1 MENU Select **USB**.

2 ENTER Select **PHOTO LIST**.

1 Moves to upper level file
2 Preview: Display the thumbnail/folder name of the photo in the selected folder
3 Current page/Total pages
4 Total number of marked photos
5 Usable USB memory
6 Corresponding buttons on the remote control

PHOTO LIST
 Page 1/1 No Marked
 USB Device
 Free Space 150MB

TOP FOLDER
 Drive1
 2Folders, 4Files
 Upper

Drive1

1

2

3

4

5

6

Navigate PopUp Menu CH Move Page FAV Mark RETURN Exit

USB

Photo Selection and Popup Menu

- 1** Select the target folder or drive.
- 2** Select the desired photos.
- 3** Show the Popup menu.
- 4** Select the desired Popup menu.

PHOTO LIST
 Page 1/1 No Marked
 USB Device
 Free Space 150MB

TOP FOLDER
 Drive1
 2Folders, 4Files
 Upper

Drive1

Navigate PopUp Menu CH Move Page FAV Mark RETURN Exit

PHOTO LIST
 Page 1/1 No Marked
 USB Device
 Free Space 150MB

Drive1
 Butterfly
 1366x768 125KB
 Upper

Upper Photo X.Box

1366x768 125KB
 View
 Mark All
 Delete
 Cancel

Navigate PopUp Menu CH Move Page FAV Mark RETURN Exit









- Use the **CH** ^ v button to navigation in the photo page.
- Use the **FAV** button to mark or unmark a photo. When one or more photos are marked, you can view individual photos or a slide show of the marked photos. If no photos are marked, you can view all photos individually or all photos in the folder in a slide show.

- When you select a file (not folder), this PopUp menu is displayed.
- ▶ **View:** Display the selected item.
 - ▶ **Mark All:** Mark all photos on the screen.
 - ▶ **Unmark All:** Deselect all marked photos.
 - ▶ **Delete:** Delete the selected photo item.
 - ▶ **Cancel:** Close the pop-up menu.

USB

Full Screen Menu

You can change the Photo List view so that it fills the screen. More operations are available in full screen mode.

- 1  Select the target folder or drive.
- 2   Select the desired photos.
- 3  Show the Popup menu.
- 4  Select **View**.
- 5  The selected photo is displayed in full size.
- 6   Select the **Sideshow, BGM, (Rotate), Delete, Option, or Hide**.

- ▶ **Sideshow:** Selected photos are displayed during the slide show. If no photo is selected, all photos in the current folder are displayed during slide show.
 - Set the time interval of the slide show in **Option**.
 - A slide show continues for a maximum of 4 hours. After 4 hours, the slide show will end and go to TV mode or external input mode.
- ▶ **BGM:** Listen to music while viewing photos in full size.
 - Set the BGM device and album in **Option**.
- ▶ **(Rotate):** Rotate photos.
 - Rotates the photo 90°, 180°, 270°, 360° clockwise.
- ▶ **Delete:** Delete photos.
- ▶ **Option:** Set values for **Slide Speed** and **Music Folder**.
 - Use < > button and **ENTER** button to set values. Then go to **Enter** and press **ENTER** to save the settings.
 - You cannot change **Music Folder** while BGM is playing.
- ▶ **Hide :** Hide the menu on the full-sized screen.
 - To see the menu again on the full-sized screen, press **ENTER** button to display.

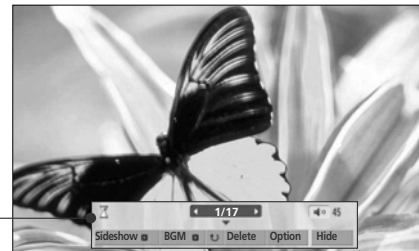
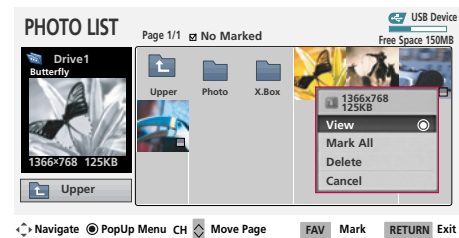
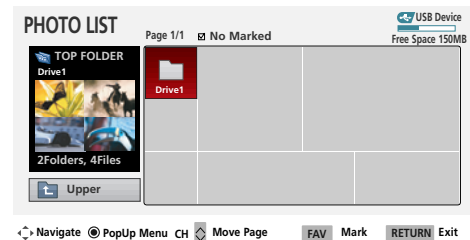

The aspect ratio of a photo may change the size of the photo displayed on the screen in full size.

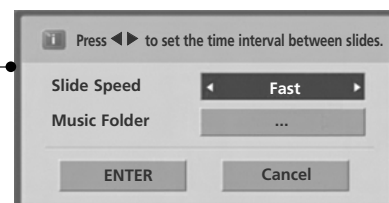

NOTE

- ▶ This TV will not be able to decode most JPG images saved using the Progressive option.

MUSIC LIST

You can use the Music List menu to play MP3 files from a USB storage device.

This TV cannot play back copy-protected files.

The On Screen Display on your model may be slightly different.

Supported music file: *.MP3

Bit rate range 40Kbps ~ 320Kbps

• Sampling rate (Sampling Frequency)

MPEG1 : 32000, 44100, 48000Hz

MPEG2 : 16000, 24000, 22050Hz

MPEG2.5 : 16 ~ 48KHz

USB

Screen Components

1



Select **USB**.

2

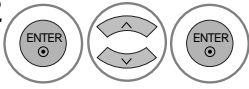

Select **MUSIC LIST**.

- ① Moves to upper level file
- ② Preview: If any album jacket for the file exists, this jacket is displayed.
- ③ Current page/Total pages
- ④ Total number of marked musics
- ⑤ Usable USB memory
- ⑥ Corresponding buttons on the remote control

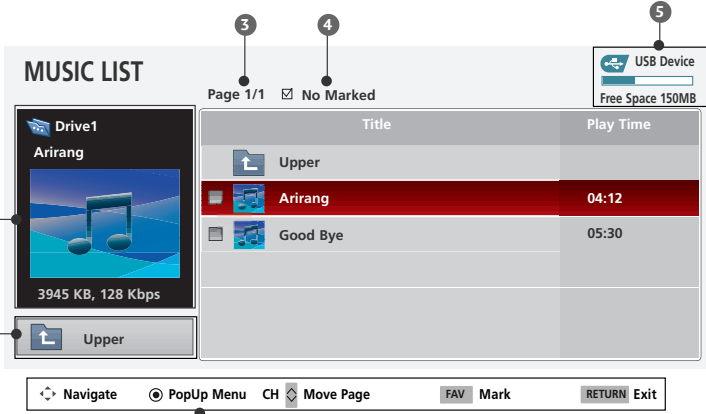









The screenshot shows the MUSIC LIST interface. At the top, it says 'MUSIC LIST' and 'Page 1/1' with a checkbox for 'No Marked'. On the right, it shows 'USB Device' and 'Free Space 150MB'. The main area is a table with columns 'Title' and 'Play Time'. The table contains three rows: 'Upper', 'Arirang' (highlighted in red), and 'Good Bye'. On the left, there is a preview window for 'Arirang' showing a music note icon and file details: '3945 KB, 128 Kbps'. At the bottom, there is a navigation bar with buttons: 'Navigate', 'PopUp Menu', 'CH', 'Move Page', 'FAV', 'Mark', and 'RETURN Exit'.

USB

Music Selection and Popup Menu

Up to 6 music titles are listed per page.



- 1  Select the target folder or drive.
- 2   Select the desired musics.
- 3  show the PopUp menu.
- 4   Select the desired PopUp menu.
- 5  Return to TV viewing.

- Use the **CH**   button to navigation in the music page.
- Use **FAV** button to mark or unmark a music file. If no music is marked, all the music in the folder will be played in sequence. When one or more music files are marked, the marked music files will be played in sequence. If you want to listen to only one song repeatedly, just mark that one file and play.

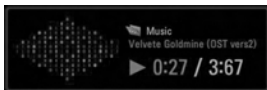
- The play information box (as shown below) will automatically move across the screen when there is no user input to prevent a fixed image remaining on the screen for an extended period of time.



NOTE

- ▶ When music is playing,  is displayed in front of the music play time.
- ▶ A damaged or corrupted music file that does not play displays 00:00 as the play time.
- ▶ Music files with copy-protection will not play.
- ▶ Press **ENTER**, , or **RETURN** button to stop the screen saver.
- ▶ This TV can not play music files less than 16 Kbytes.

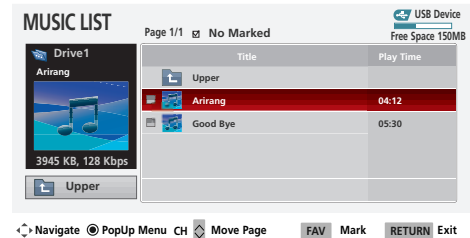

▶ Navigate  CH  FAV Mark RETURN Exit

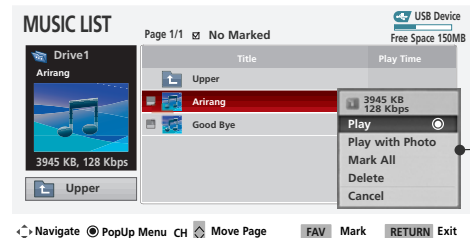

▶ Navigate  CH  FAV Mark RETURN Exit

- ▶ **Play** (During stop): Play the selected music. Once a song finishes playing, the next selected one will be played. When there are no selected musics to play, the next one in the current folder will be played. If you go to a different folder and press the **ENTER** button, the current music in playback will stop.
- ▶ **Play Marked**: Play the selected musics. Once a music finishes playing, the next selected one will be played automatically.
- ▶ **Stop Play** (During playback): Stop the playing musics.
- ▶ **Play with Photo**: Start playing the selected musics and then move to the Photo List.
- ▶ **Mark All**: Mark all musics in the folder.
- ▶ **Unmark All**: Deselect all marked music.
- ▶ **Delete**: Delete the selected music.
- ▶ **Cancel**: Close the pop-up menu.

APPENDIX

TROUBLESHOOTING

The operation does not work normally.

The remote control doesn't work	<ul style="list-style-type: none"> ■ Check to see if there is any object between the product and the remote control causing obstruction. Ensure you are pointing the remote control directly at the TV. ■ Ensure that the batteries are installed with correct polarity (+ to +, - to -). ■ Ensure that the correct remote operating mode is set: TV, VCR etc. ■ Install new batteries.
Power is suddenly turned off	<ul style="list-style-type: none"> ■ Is the sleep timer set? ■ Check the power control settings. Power interrupted.

The video function does not work.

No picture & No sound	<ul style="list-style-type: none"> ■ Check whether the product is turned on. ■ Try another channel. The problem may be with the broadcast. ■ Is the power cord inserted into wall power outlet? ■ Check your antenna direction and/or location. ■ Test the wall power outlet, plug another product's power cord into the outlet where the product's power cord was plugged in.
Picture appears slowly after switching on	<ul style="list-style-type: none"> ■ This is normal, the image is muted during the product startup process. Please contact your service center, if the picture has not appeared after five minutes.
No or poor color or poor picture	<ul style="list-style-type: none"> ■ Adjust Color in menu option. ■ Keep a sufficient distance between the product and the VCR. ■ Try another channel. The problem may be with the broadcast. ■ Are the video cables installed properly? ■ Activate any function to restore the brightness of the picture.
Horizontal/vertical bars or picture shaking	<ul style="list-style-type: none"> ■ Check for local interference such as an electrical appliance or power tool.
Poor reception on some channels	<ul style="list-style-type: none"> ■ Station or cable product experiencing problems, tune to another station. ■ Station signal is weak, reorient antenna to receive weaker station. ■ Check for sources of possible interference.
Lines or streaks in pictures	<ul style="list-style-type: none"> ■ Check antenna (Change the direction of the antenna).
No picture when connecting HDMI	<ul style="list-style-type: none"> ■ Check HDMI cable over version 1.3. The HDMI cables don't support HDMI version 1.3, it cause flickers or no screen display. In this case use the latest cables that support HDMI version 1.3.

APPENDIX

The audio function does not work.

Picture OK & No sound	<ul style="list-style-type: none"> ■ Press the VOL or VOLUME button. ■ Sound muted? Press MUTE button. ■ Try another channel. The problem may be with the broadcast. ■ Are the audio cables installed properly?
No output from one of the speakers	<ul style="list-style-type: none"> ■ Adjust Balance in menu option.
Unusual sound from inside the product	<ul style="list-style-type: none"> ■ A change in ambient humidity or temperature may result in an unusual noise when the product is turned on or off and does not indicate a fault with the product.
No sound when connecting HDMI or USB	<ul style="list-style-type: none"> ■ Check HDMI cable over version 1.3. ■ Check USB cable over version 2.0. ■ Use normal MP3 file.

There is a problem in PC mode. (Only PC mode applied)

The signal is out of range	<ul style="list-style-type: none"> ■ Adjust resolution, horizontal frequency, or vertical frequency. ■ Check the input source.
Vertical bar or stripe on background & Horizontal Noise & Incorrect position	<ul style="list-style-type: none"> ■ Work the Auto configure or adjust clock, phase, or H/V position. (Option)
Screen color is unstable or single color	<ul style="list-style-type: none"> ■ Check the signal cable. ■ Reinstall the PC video card.

MAINTENANCE

Early malfunctions can be prevented. Careful and regular cleaning can extend the amount of time you can enjoy your new TV.

Caution: Be sure to turn the power off and unplug the power cord before you begin any cleaning.

Cleaning the Screen

- 1 Here's a great way to keep the dust off your screen for a while. Wet a soft cloth in a mixture of lukewarm water and a little fabric softener or dish washing detergent. Wring the cloth until it's almost dry, and then use it to wipe the screen.
- 2 Make sure the excess water is off the screen, and then let it air-dry before you turn on your TV.

Cleaning the Cabinet

- To remove dirt or dust, wipe the cabinet with a soft, dry, lint-free cloth.
- Please be sure not to use a wet cloth.

Extended Absence

⚠ CAUTION

- ▶ If you expect to leave your TV dormant for a long time (such as a vacation), it's a good idea to unplug the power cord to protect against possible damage from lightning or power surges.

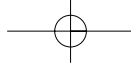

PRODUCT SPECIFICATIONS

MODELS		32LG30 (32LG30-UA) (32LG30-UD)	37LG30 (37LG30-UA) (37LG30-UD)	42LG30 (42LG30-UA) (42LG30-UD)
Dimensions (Width x Height x Depth)	With stand	31.5 x 23.7 x 8.9 inches 801.8 x 604.2 x 227.3 mm	36.2 x 26.8 x 11.5 inches 919.6 x 682.3 x 293.8 mm	40.6 x 29.2 x 11.5 inches 1032.8 x 742.3 x 293.8 mm
	Without stand	31.5 x 21.4 x 3.1 inches 801.8 x 544.1 x 79.0 mm	36.2 x 24.0 x 3.5 inches 919.6 x 610.3 x 89.0 mm	40.6 x 26.3 x 3.6 inches 1032.8 x 670.1 x 92.0 mm
Weight	With stand	29.5 pounds / 13.4 kg	41.4 pounds / 18.8 kg	52.0 pounds / 23.6 kg
	Without stand	26.2 pounds / 11.9 kg	35.7 pounds / 16.2 kg	46.2 pounds / 21.0 kg
MODELS		37LG50 (37LG50-UA) (37LG50-UG)	42LG50 (42LG50-UA) (42LG50-UG)	
Dimensions (Width x Height x Depth)	With stand	36.8 x 26.9 x 11.5 inches 936.4 x 685.4 x 293.4 mm	40.7 x 28.9 x 11.5 inches 1034.0 x 735.0 x 294.0 mm	
	Without stand	36.8 x 24.1 x 3.4 inches 936.4 x 612.8 x 88.0 mm	40.7 x 26.1 x 3.5 inches 1034.0 x 663.0 x 91.0 mm	
Weight	With stand	40.3 pounds / 18.3 kg	54.0 pounds / 24.5 kg	
	Without stand	34.3 pounds / 15.6 kg	48.5 pounds / 22.0 kg	
MODELS		47LG50 (47LG50-UA) (47LG50-UG)	52LG50 (52LG50-UA) (52LG50-UG)	
Dimensions (Width x Height x Depth)	With stand	45.5 x 32.0 x 13.5 inches 1156.2 x 813.1 x 342.9 mm	50.8 x 35.1 x 13.5 inches 1291.7 x 892.2 x 342.9 mm	
	Without stand	45.5 x 29.1 x 4.0 inches 1156.2 x 739.2 x 103.0 mm	50.8 x 32.1 x 4.5 inches 1291.7 x 817.0 x 115.3 mm	
Weight	With stand	64.3 pounds / 29.2 kg	87.0 pounds / 39.5 kg	
	Without stand	54.2 pounds / 24.6 kg	76.9 pounds / 34.9 kg	
Power requirement		AC100-240V ~ 50/60Hz		
Television System		NTSC-M, ATSC, 64 & 256 QAM		
Program Coverage		VHF 2-13, UHF 14-69, CATV 1-135, DTV 2-69, CADTV 1-135		
External Antenna Impedance		75 ohm		
Environment condition	Operating Temperature	32 ~ 104°F (0 ~ 40°C)		
	Operating Humidity	Less than 80%		
Environment condition	Storage Temperature	-4 ~ 140°F (-20 ~ 60°C)		
	Storage Humidity	Less than 85%		

■ The specifications shown above may be changed without prior notice for quality improvement.

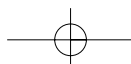

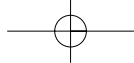

APPENDIX

APPENDIX

MODELS		32LG60 (32LG60-UA)	37LG60 (37LG60-UA)	42LG60 (42LG60-UA)
Dimensions (Width x Height x Depth)	With stand	31.7 x 24.6 x 13.1 inches 805.6 x 626.0 x 333.0mm	36.5 x 27.8 x 14.7 inches 929.0 x 706.9 x 374.7 mm	40.8 x 31.3 x 14.9 inches 1037.8 x 796.4 x 379.5 mm
	Without stand	31.7 x 23.1 x 3.7 inches 805.6 x 587.4 x 96.2 mm	36.5 x 26.1 x 3.8 inches 929.0 x 665.0 x 98.7 mm	40.8 x 29.4 x 3.1 inches 1037.8 x 747.0 x 80.8 mm
Weight	With stand	31.7 pounds / 14.4 kg	46.7 pounds / 21.2 kg	53.1 pounds / 24.1 kg
	Without stand	26.8 pounds / 12.2 kg	39.9 pounds / 18.1 kg	44.9 pounds / 20.4 kg
MODELS		47LG60 (47LG60-UA)	52LG60 (52LG60-UA)	
Dimensions (Width x Height x Depth)	With stand	45.3 x 34.1 x 17.1 inches 1152.8 x 868.6 x 434.5 mm	50.3 x 37.1 x 16.9 inches 1280.1 x 944.7 x 430.0 mm	
	Without stand	45.3 x 32.3 x 3.1 inches 1152.8 x 820.8 x 79.0 mm	50.3 x 35.2 x 3.5 inches 1280.1 x 896.0 x 89.0 mm	
Weight	With stand	71.8 pounds / 32.6 kg	99.2 pounds / 45.0 kg	
	Without stand	59.3 pounds / 26.9 kg	83.9 pounds / 38.1 kg	
MODELS		32LG70 (32LG70-UA)	42LG70 (42LG70-UA)	
Dimensions (Width x Height x Depth)	With stand	31.3 x 23.5 x 8.9 inches 797.0 x 597.0 x 227.3 mm	40.4 x 28.8 x 11.5 inches 1026.2 x 734.0 x 293.4 mm	
	Without stand	31.3 x 21.9 x 3.9 inches 797.0 x 558.6 x 100.5 mm	40.4 x 27.0 x 4.4 inches 1026.2 x 687.9 x 111.8 mm	
Weight	With stand	28.4 pounds / 12.9 kg	49.3 pounds / 22.4 kg	
	Without stand	25.1 pounds / 11.4 kg	43.4 pounds / 19.7 kg	
MODELS		47LG70 (47LG70-UA)	52LG70 (52LG70-UA)	
Dimensions (Width x Height x Depth)	With stand	44.8 x 32.2 x 13.5 inches 1140.4 x 820.1 x 342.9 mm	50.5 x 35.3 x 13.5 inches 1284.4 x 898.6 x 342.9 mm	
	Without stand	44.8 x 30.1 x 5.0 inches 1140.4 x 764.8 x 129.0 mm	50.5 x 33.2 x 5.0 inches 1284.4 x 844.6 x 129.5 mm	
Weight	With stand	66.3 pounds / 30.1 kg	87.9 pounds / 39.9 kg	
	Without stand	55.9 pounds / 25.4 kg	77.6 pounds / 35.2 kg	
Power requirement Television System Program Coverage External Antenna Impedance		AC100-240V ~ 50/60Hz NTSC-M, ATSC, 64 & 256 QAM VHF 2-13, UHF 14-69, CATV 1-135, DTV 2-69, CADTV 1-135 75 ohm		
Environment condition	Operating Temperature Operating Humidity	32 ~ 104°F (0 ~ 40°C) Less than 80%		
	Storage Temperature Storage Humidity	-4 ~ 140°F (-20 ~ 60°C) Less than 85%		

■ The specifications shown above may be changed without prior notice for quality improvement.

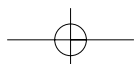

MODÈLES		42PG25 (42PG60-UA)	50PG25 (50PG60-UA)
Dimensions (Width x Height x Depth)	With stand	41.1 x 28.9 x 12.1 inches 1044.4 x 735.4 x 308.0 mm	48.6 x 33.4 x 14.3 inches 1235.6 x 849.3 x 364.1 mm
	Without stand	41.1 x 26.7 x 3.1 inches 1044.4 x 680.6 x 79.6 mm	48.6 x 31.2 x 3.1 inches 1235.6 x 792.8 x 79.6 mm
Weight	With stand	61.7 pounds / 28.0 kg	96.3 pounds / 43.7 kg
	Without stand	55.1 pounds / 25.0 kg	87.5 pounds / 39.7 kg
MODÈLES		50PG60 (50PG60F-UA)	60PG60 (60PG60F-UA)
Dimensions (Width x Height x Depth)	With stand	48.6 x 33.4 x 14.3 inches 1235.6 x 849.3 x 364.1 mm	57.3 x 38.8 x 16.3 inches 1455.0 x 985.0 x 414.0 mm
	Without stand	48.6 x 31.2 x 3.1 inches 1235.6 x 792.8 x 79.6 mm	57.3 x 36.4 x 3.3 inches 1455.0 x 924.8 x 84.1 mm
Weight	With stand	100.7 pounds / 45.7 kg	137.5 pounds / 62.4 kg
	Without stand	91.9 pounds / 41.7 kg	121.0 pounds / 54.9 kg
Power requirement Television System Program Coverage External Antenna Impedance		AC100-240V ~ 50/60Hz NTSC-M, ATSC, 64 & 256 QAM VHF 2-13, UHF 14-69, CATV 1-135, DTV 2-69, CADTV 1-135 75 ohm	
Environment condition	Operating Temperature Operating Humidity	32 ~ 104°F (0 ~ 40°C) Less than 80%	
	Storage Temperature Storage Humidity	-4 ~ 140°F (-20 ~ 60°C) Less than 85%	

- The specifications shown above may be changed without prior notice for quality improvement.

OPEN SOURCE SOFTWARE NOTICE - *This feature is not available for all models.*

The following GPL executables and LGPL/MPL libraries used in this product are subject to the GPL/LGPL/MPL License Agreements:

GPL EXECUTABLES:

- Linux kernel 2.6.12
- busybox

LGPL LIBRARIES:

- uclibc

MPL LIBRARIES:

- Nanox

LG Electronics offers to provide source code to you on CD-ROM for a charge covering the cost of

performing such distribution, such as the cost of media, shipping and handling upon e-mail request to LG Electronics at: Opensource@lge.com

This offer is valid for a period of three(3) years from the date of the distribution of this product by LG Electronics.

You can obtain a copy of the GPL, LGPL and MPL licenses on the CD-ROM provided with this product.

- This software is based in part on the work of the Independent JPEG Group.
- This software includes the Zlib compression library, developed by Jean-loup Gailly and Mark Adler. Copyright (C) 1995-2005 Jean-loup Gailly and Mark Adler



CHILD SAFETY:

It Makes A Difference How and Where
You Use Your Flat Panel Display

Congratulations on your purchase! As you enjoy your new product, please keep these safety tips in mind:



THE ISSUE

- The home theater entertainment experience is a growing trend and larger flat panel displays are popular purchases. However, flat panel displays are not always supported on the proper stands or installed according to the manufacturer's recommendations.
- Flat panel displays that are inappropriately situated on dressers, bookcases, shelves, desks, speakers, chests or carts may fall over and cause injury.

THIS MANUFACTURER CARES!

- The consumer electronics industry is committed to making home entertainment enjoyable and safe.

TUNE INTO SAFETY

- One size does NOT fit all. Follow the manufacturer's recommendations for the safe installation and use of your flat panel display.
- Carefully read and understand all enclosed instructions for proper use of this product.
- Don't allow children to climb on or play with furniture and television sets.
- Don't place flat panel displays on furniture that can easily be used as steps, such as a chest of drawers.
- Remember that children can become excited while watching a program, especially on a "larger than life" flat panel display. Care should be taken to place or install the display where it cannot be pushed, pulled over, or knocked down.
- Care should be taken to route all cords and cables connected to the flat panel display so that they cannot be pulled or grabbed by curious children.

WALL MOUNTING: IF YOU DECIDE TO WALL MOUNT YOUR FLAT PANEL DISPLAY, ALWAYS:

- Use a mount that has been recommended by the display manufacturer and/or listed by an independent laboratory (such as UL, CSA, ETL).
- Follow all instructions supplied by the display and wall mount manufacturers.
- If you have any doubts about your ability to safely install your flat panel display, contact your retailer about professional installation.
- Make sure that the wall where you are mounting the display is appropriate. Some wall mounts are not designed to be mounted to walls with steel studs or old cinder block construction. If you are unsure, contact a professional installer.
- A minimum of two people are required for installation. Flat panel displays can be heavy.



CEA
 Consumer Electronics Association
www.CE.org/safety