



Dear VIZIO Customer,

Congratulations on your new VIZIO VP50 High Definition Plasma Television purchase. Thank you for your support. For maximum benefit of your set, please read these instructions before making any adjustments, and retain them for future reference. We hope you will experience many years of enjoyment from your new VIZIO VP50 High Definition Television.

For assistance, please call (949) 428-2525 or e-mail us at techsupport@vizio.com.

To purchase or inquire about accessories and installation services for your VIZIO Plasma HDTV, please visit our website at www.VIZIO.com or call toll free at **888-VIZIOCE (888-849-4623)**.

We recommend you register your VIZIO VP50 HDTV20A either at our website www.VIZIO.com or fill in your registration card and mail it in. For peace of mind and to protect your investment beyond the standard warranty, VIZIO offers on-site extended warranty service plans. These plans give additional coverage during the standard warranty period. Visit our website or call us to purchase a plan.

Write down the serial number located on the back of your VP50 HDTV20A.

Purchase Date _____

VIZIO is a registered trademark of V, Inc.

HDMI logo and "High Definition Multimedia Interface" are registered trademarks of HDMI Licensing LLC.

Manufactured under license from Dolby Laboratories.

Dolby and the double-D symbol are trademarks of Dolby Laboratories.



THIS PRODUCT HAS BEEN DESIGNED AND TESTED FOR COMPLIANCE WITH REGULATORY SAFETY CERTIFICATIONS

This product is designed and manufactured to operate within defined design limits, and misuse may result in electric shock or fire. To prevent the product from being damaged, the following rules should be observed for the installation, use and maintenance of the product. Read the following safety instructions before operating the display. Keep these instructions in a safe place for future reference.

- To avoid the risk of electric shock or component damage, switch off the power before connecting other components to the VP50 HDTV20A.
- Unplug the power cord before cleaning the VP50 HDTV20A. A damp cloth is sufficient for cleaning the VP50 HDTV20A. Do not use a liquid or a spray cleaner for cleaning the product. Do not use abrasive cleaners.
- Always use the accessories recommended by the manufacturer to insure compatibility.
- When moving the VP50 HDTV20A from an area of low temperature to an area of high temperature, condensation may form on the housing. Do not turn on the VP50 HDTV20A immediately after this to avoid causing fire, electric shock or component damage.
- Do not place the VP50 HDTV20A on an unstable cart, stand, or table. If the VP50 HDTV20A falls, it can injure a person and cause serious damage to the appliance. Use only a cart or stand recommended by the manufacturer or sold with the VP50 HDTV20A.
- A distance of at least 3 feet should be maintained between the VP50 HDTV20A and any heat source, i.e. radiator, heater, oven, amplifier etc. Do not install the product close to smoke. Operating the product close to smoke or moisture may cause fire or electric shock.
- Slots and openings in the back and bottom of the cabinet are provided for ventilation. To ensure reliable operation of the VP50 HDTV20A and to protect it from overheating, be sure these openings are not blocked or covered. Do not place the VP50 HDTV20A in a bookcase or cabinet unless proper ventilation is provided.
- Never push any object into the slot on the VP50 HDTV20A cabinet. Do not place any objects on the top of the product. It could short circuit parts causing a fire or electric shock. Never spill liquids on the VP50 HDTV20A.
- The VP50 HDTV20A should be operated only from the type of power source indicated on the label. If you are not sure of the type of power supplied to your home, consult your dealer or local power company.
- The power cable must be replaced when using different voltage from that specified in the User Manual. For more information, contact your dealer.
- The VP50 HDTV20A is equipped with a **three-pronged grounded plug, a plug with a third (grounding) pin**. This plug will fit only into a grounded power outlet as a safety feature. If your outlet does not accommodate the three-wire plug, have an electrician install the correct outlet, or use an adapter to ground the appliance safely. **Do not defeat the safety purpose of the grounded plug.**
- Do not overload power strips and extension cords. Overloading can result in fire or electric shock.
- The wall socket shall be installed near the equipment and shall be easily accessible.
- Only the marked power source can be used for the product. Any power source other than the specified one may cause fire or electric shock.
- Do not touch the power cord during lightning. To avoid electric shock, avoid handling the power cord during electrical storms.
- Unplug the unit during a lightning storm or when it will not be used for long period of time. This will protect the VP50 HDTV20A from damage due to power surges.
- Do not attempt to repair or service the product yourself. Opening or removing the back cover may expose you to high voltages, the risk of electric shock, and other hazards. If repair is required, please contact your dealer and refer all servicing to qualified service personnel.
- Keep the product away from moisture. Do not expose this appliance to rain or moisture. If water penetrates into the product, unplug the power cord and contact your dealer. Continuous use in this case may result in fire or electric shock.
- Do not use the product if any abnormality occurs. If any smoke or odor becomes apparent, unplug the power cord and contact your dealer immediately. Do not try to repair the product yourself.
- Avoid using dropped or damaged appliances. If the product is dropped and the housing is damaged, the internal components may function abnormally. Unplug the power cord immediately and contact your dealer for repair. Continued use of the product may cause fire or electric shock.
- Do not install the product in an area with heavy dust or high humidity. Operating the product in environments with heavy dust or high humidity may cause fire or electric shock.
- Follow instructions for moving the product. Ensure that the power connector and any other cables are unplugged before moving the product.
- Hold the power connector when removing the power cable. Pulling the power cable itself may damage the wires inside the cable and cause fire or electric shock. When the product will not be used for an extended period of time, unplug the power connector.
- To avoid risk of electric shock, do not touch the connector with wet hands.
- Insert batteries in accordance with instructions. Incorrect polarities may cause damage and leakage of the batteries, operator injury and contamination the remote controller.
- If any of the following occurs please contact the dealer:
 - The power connector fails or frays.
 - Liquid sprays or any object drops into the VP50 HDTV20A.
 - The Display is exposed to rain or other moisture.
 - The Display is dropped or damaged in any way.
 - The performance of the Display changes substantially.



Television Antenna Connection Protection

External Television Antenna Grounding

If an outside antenna/satellite dish or cable system is to be connected to the TV, make sure that the antenna or cable system is electrically grounded to provide some protection against voltage surges and static charges.

Article 810 of the National Electrical Code, ANSI/NFPA 70, provides information with regard to proper grounding of the mast and supporting structure, grounding of the lead-in wire to an antenna discharge unit, size of the grounding conductors, location of antenna discharge unit, connection to grounding electrodes, and requirements of the grounding electrode.

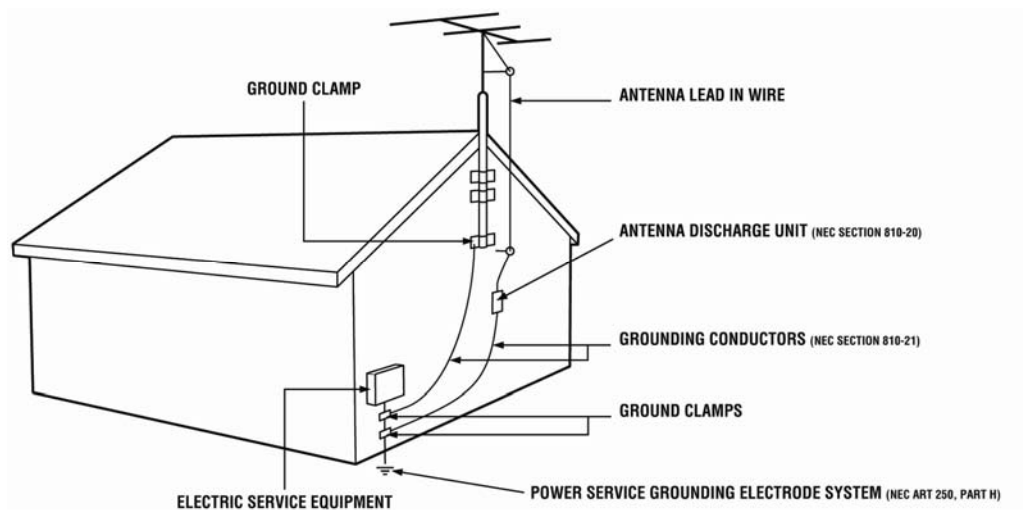

Lightning Protection

For added protection of the TV during a lightning storm or when it is left unattended or unused for long periods of time, unplug the TV from the wall outlet and disconnect the antenna or cable system.

Power Lines

Do not locate the antenna near overhead light or power circuits, or where it could fall into such power lines or circuits.

Remember, the screen of the coaxial cable is intended to be connected to earth in the building installation.



Opening the Package

Your VIZIO VP50 HDTV20A and its accompanying accessories are carefully packed in a cardboard carton that has been designed to protect it from transportation damage. Now you have opened the carton, check that the VP50 HDTV20A is in good condition and that all of the accessories are included.

The VP50 HDTV20A weighs over 120lbs and is about 49" wide x 34.5" tall, we strongly advise that you have at least 2 people to unpack and install the HDTV.

The glass surface can easily be scratched or broken, so please handle the product gently and never place the HDTV with the glass facing downwards on a surface without protective padding.

IMPORTANT: Save the carton and packing material for future shipping.

Package Contents

VIZIO VP50 HDTV20A
VIZIO Remote Control by Universal Electronics
Power Cord
Safety Strap
VIZIO Bezel and Screen Cleaning Cloth
This User Manual
Quick Setup Guide
Registration Card
VIP Services Brochure
2 (Double A) Batteries for the Remote Control
Warranty Card and Repair Information



Additional Certified Accessories for the VIZIO VP50 HDTV20A are sold separately

Wall Mounts
High Definition Cables
Extra or replacement Remote

VIZIO also offers Installation Services and Extended Warranty Services for your VIZIO VP50 HDTV20A

To purchase or inquire about additional accessories and services for your VIZIO product, visit our web site at www.VIZIO.com or call us toll free at 888-VIZIOCE (888-849-4623)

Installation Preparation

Please read this user manual carefully before installing your VIZIO HDTV.

The power consumption of the TV is about 500W, please use the power cord designated for TV. When an extension cord is required, use one with the correct power rating. The cord must be grounded and the grounding feature must not be defeated.

The TV should be installed on a flat surface to avoid tipping. For proper ventilation, you must allow space between the back of the TV and the wall. If you would like to mount your TV on the wall, please see below 'Preparing Your Plasma HDTV for Wall Mounting' for additional information. Avoid installing the TV in places with high humidity, dust or smoke so as not to shorten the service life of the electronic components.

Install the TV in landscape orientation; any 90° clockwise or counter-clockwise installation may induce poor ventilation and excessive component damage.

VIZIO offers professional installation services. Please contact VIZIO for more information on these services at 888-VIZIOCE (888-849-4623) or www.VIZIO.com.

Attaching the Safety Strap

For when the VP50 HDTV20A is not mounted on the wall with a Wall Mount, a Safety Strap has been included to attach the HDTV to the wall to reduce the chance of the HDTV being pulled over. The Safety Strap should be used with common sense practice such as ensuring that children (or adults) do not climb up, grabbing the top of the HDTV and pulling it onto themselves.

1. Fix one end of the strap to the wall. If you have a drywall finish it is preferable to fix it to a stud, using a washer underneath the screw head. If you have a solid wall you should use a lag bolt, again using a washer under the nut.



2. Fix the other end of the Safety Strap to one of the upper wall mounting holes on the back of the HDTV, using a washer under the screw head.



Preparing Your Plasma HDTV for Wall Mounting

The VIZIO VP50 can either be kept on the stand base or mounted on the wall for viewing. If you choose to mount the VP50 on the wall, please follow the instructions below for removing the stand base.

To remove the stand base

1. Unplug all of the cables and cords from your VP50 HDTV20A.
2. Place the VP50 HDTV20A face down on a soft and flat surface (blanket, foam, cloth, etc) to prevent any damage to the TV.
3. Remove the six (6) screws on each side of the back panel of the VP50 HDTV20A located near the bottom so that the stand base can be removed (see Figure A).

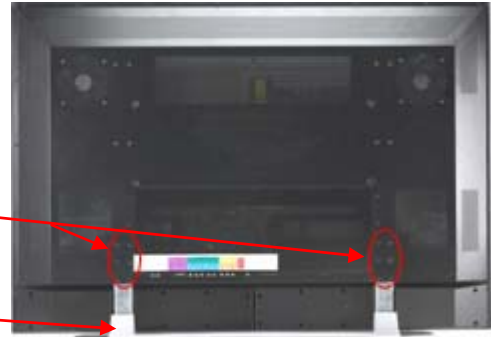

4. Gently pull the stand away from the VP50 HDTV20A by grasping firmly on the base.
5. Now, the VP50 HDTV20A can firm securely to a mount (sold separately) by utilizing the mounting holes in the center of the back panel of the TV (see Figure B). Please make sure to read the instructions of your specific mount to properly hang the VP50 HDTV20A.

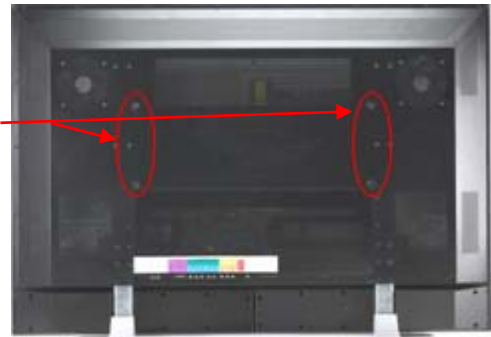

To find the perfect mount for the VIZIO VP50 HDTV20A, browse VIZIO's certified mount selection at www.vizio.com or call directly 888-VIZIOCE (888-849-4623).



Table of Contents

Chapter 1 Basic Controls and Connections	9
1.1 Front Panel.....	9
1.2 Side Panel Controls.....	9
1.3 Rear Panel Connections	10
1.4 VIZIO Universal Remote Control	12
1.4.1 Insertion of Batteries in the Remote Control	14
1.4.2 Remote Control Range	14
1.4.3 VIZIO Remote Control Precautions	14
Chapter 2 Connecting Equipment	15
2.1 Which Video Connection Should I Use?.....	15
2.2 Connecting Coaxial (RF)	16
2.2.1 Using Your Antenna or Digital Cable for DTV / TV	16
2.2.2 Using the Antenna or Cable through your VCR	17
2.3 Connecting Your HDTV Set-Top Box	18
2.3.1 Using HDMI	18
2.3.2 Using Component Video	20
2.4 Connecting Your Basic Set-Top Box	21
2.4.1 Using Composite Video	21
2.4.2 Using Coax (RF)	21
2.5 Connecting Your DVD Player	22
2.5.1 Using HDMI	22
2.5.2 Using Component Video	24
2.5.3 Using S-Video (AV3).....	25
2.5.4 Using Composite (AV) Video	25
2.5.5 Connecting Your VCR or Video Camera	26
2.6 Connecting an external Receiver/Amp	27
2.7 Connecting a PC Computer	28
2.7.1 Preset PC Resolutions.....	28
Chapter 3 Setting Up to Watch Television.....	29
3.1 Basic Plasma HDTV Start Up.....	29
3.2 Watching a TV Program	34
3.3 Adjusting Basic HDTV Settings	34
3.4 Program Information.....	35
3.5 Information on HDTV Status	35
Chapter 4 Advanced Adjustment of HDTV.....	36
4.1 Using the On Screen Display (OSD)	36
4.2 DTV / TV Input Picture Adjustment.....	37
4.2.1 Picture Mode	37
4.2.2 Brightness.....	37
4.2.3 Contrast	38
4.2.4 Color.....	38
4.2.5 Tint.....	38
4.2.6 Sharpness	39
4.2.7 Color Temperature.....	39
4.2.8 Advanced Video	40
4.3 DTV / TV Input Audio Adjustment.....	42
4.3.1 Volume	42
4.3.2 Bass.....	42
4.3.3 Treble	43
4.3.4 Balance.....	43
4.3.5 Surround.....	43
4.3.6 Speakers	43
4.4 DTV / TV Tuner Setup.....	44
4.4.1 Tuner Mode	44
4.4.2 Auto Search	44
4.4.3 Skip Channel	44
4.4.4 Digital Audio Out.....	44
4.4.5 Time Zone	45
4.4.6 Daylight Saving.....	45



4.5 DTV / TV Input Setup	46
4.5.1 Language.....	46
4.5.2 PIP (Picture-in-Picture)	46
4.5.3 Sleep Timer	46
4.5.4 Analog Closed Caption	47
4.5.5 Digital Closed Caption	47
4.5.6 Digital Closed Caption Style	47
4.5.7 Image Cleaner	48
4.5.8 Reset All Settings	48
4.6 DTV / TV Input Parental Control.....	49
4.6.1 Channel Block	49
4.6.2 TV Rating.....	50
4.6.3 Movie Rating.....	51
4.6.4 Blocked Unrated Programming.....	51
4.6.5 Change the Password	51
4.7 HDMI Input Picture Adjustment	52
4.8 HDMI Input Audio Adjustment	52
4.9 HDMI Input Setup.....	52
4.10 Video Input Picture Adjustment	53
4.11 Video Input Audio Adjustment	53
4.12 Video Input Setup.....	53
4.13 Video Input Parental Control	54
4.14 PC Input Picture Adjustment	54
4.14.1 Auto Adjust	54
4.14.2 Brightness.....	54
4.14.3 Contrast.....	55
4.14.4 Color Temperature.....	55
4.14.5 H-SIZE.....	56
4.14.6 H. Position	56
4.14.7 V. Position	56
4.14.8 Fine Tune	56
4.15 PC Input Audio Adjustment	57
4.16 PC Input Setup.....	57
4.17 Understanding Viewing Modes.....	58
4.17.1 Picture-In-Picture (PIP) Mode	59
4.17.2 Adjusting Basic PIP Settings	59
4.17.3 Setting the Sleep Timer	14
Chapter 5 Programming the VIZIO Universal Remote Control	60
5.1.1 Programming for VCR	60
5.1.2 Programming for Cable Set-Top Box.....	60
5.1.3 Programming for DVD Player	61
5.1.4 Searching for Component Codes	61
5.2 Using a Cable or Satellite Remote	61
Chapter 6 Maintenance and Troubleshooting.....	62
6.1 Maintenance.....	62
6.2 Troubleshooting Guide	62
6.3 Telephone & Technical Support	64
6.4 Compliance	65
6.5 FCC Class B Radio Interference Statement.....	65
Chapter 7 Miscellaneous Information	66
7.1 Specifications	66
7.2 Glossary – Standard Definitions.....	67
7.3 Index	68
7.4 Component Program Codes.....	70



Chapter 1 Basic Controls and Connections

1.1 Front Panel

Power LED – Lights green when powered on, yellow when powered off.

Remote Control Sensor – This is the window through which all of the remote control signals pass to the sensor. Point the remote control directly at this window for the best response to the remote signal.



1.2 Side Panel Controls

Power () – Switch the VP50 HDTV20A on by pressing the button once. Press the button again to the VP50 HDTV20A off.

Menu – This button activates the On Screen Display (OSD). If a sub-menu is active, pressing this button will return to the previous menu level.

Channel ▲/▼ – Use these buttons to step up or down the TV channels. While the OSD is active, these buttons function as up and down controls in the OSD menus.

Volume ◀/▶ – Use these buttons to increase or decrease to the speaker volume. While the OSD is active, these buttons function as left and right controls in the OSD menus.

Input (Enter) – Repeated pressing of this buttons steps through the input sources in the following sequence: TV, AV1, AV2, AV3 (S-Video), Component1, Component2, RGB, HDMI1, HDMI2 and HDMI3. Once you have stepped through the entire sequence, you will return to the beginning.

Main
TV
AV1
AV2
AV3
COMPONENT1
COMPONENT2
RGB
HDMI1
HDMI2
HDMI3

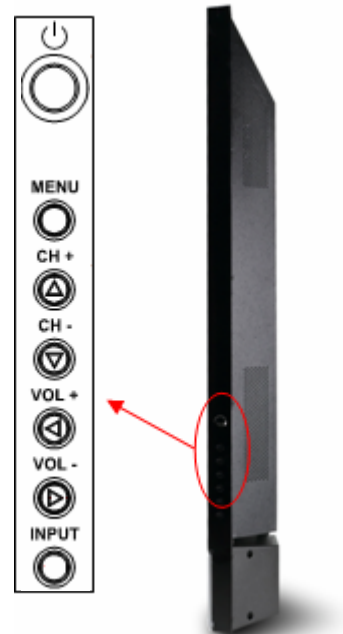

Additionally, when the OSD is active, this button confirms the menu function to be adjusted. When the OSD is not active, pressing this button will display the current input mode.



1.3 Rear Panel Connections

Right Portion

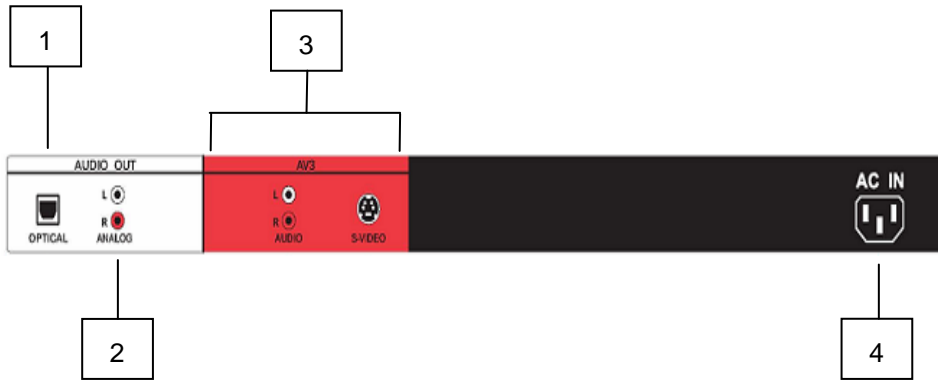

1. **OPTICAL DIGITAL AUDIO OUT** – When the DTV input is selected for viewing, the digital audio associated with digital programming will be available on this SPDIF Optical connector for connection to your home theatre system. The white color band on the rear of the TV indicates this connection.
2. **ANALOG AUDIO OUT** – Connect the audio from the Plasma HDTV to an external device, such as a home theatre system, external amplifier or stereo. Speakers cannot be connected directly to here. The white color band on the rear of the TV indicates this connection.
3. **AV3 (S-Video) IN** – Connect a third source with s-video output, such as a DVD or video game to this input. Keep in mind that S-Video connections are only images signals; therefore, a set of audio cables is needed to hear the sound. Connect the audio output of the source into L+R audio connectors next to the S-Video connector. The red color band on the rear of the TV set indicates this connection.
4. **AC IN** – Plug-in the supplied AC Power Cord here.



Left Portion

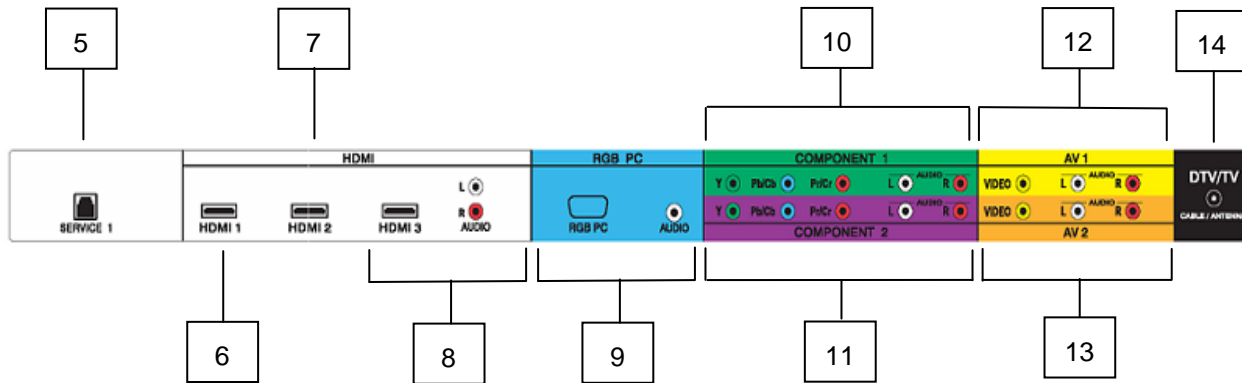

5. **SERVICE 1** – This custom communication port is for factory service only. **Use of this input for any purpose other than factory authorized service will void the manufacturer's warranty of this equipment.**
6. **HDMI1** – Connect your HDMI source for digital video such as a DVD multimedia player or set top box through this all digital connector. The white color band on the rear of the TV indicates this connection.
7. **HDMI2** – Connect your HDMI source for digital video such as a DVD multimedia player or set top box through this all digital connector. The white color band on the rear of the TV indicates this connection. Your VIZIO Certified HDMI cables are available for purchase from www.VIZIO.com or by calling 888-VIZIOCE (888-849-4623).
8. **HDMI3** – Connect your HDMI or DVI source for digital video such as a DVD multimedia player or set top box through this all digital connector. The white color band on the rear of the TV indicates this connection. For users who want to connect to a DVI enabled device, use a DVI-HDMI cable and connect the Analog Audio output of the device to the L+R AUDIO here. Your VIZIO Certified HDMI and HDMI-DVI cables are available for purchase from www.VIZIO.com or by calling 888-VIZIOCE (888-849-4623).
9. **RGB PC** – Connect the video and audio from a computer here. The blue color band on the rear of the TV indicates this connection; the audio requires a 1/8" stereo plug connector at the end going into this input.
10. **COMPONENT1 (YPb/CbPr/Cr with Audio L/R)** – Connect the primary source for component video devices such as a DVD Player or set top box here. From left to right, use green for Y, blue for Pb (or Cb), red for Pr (or Cr), white for left audio and red for right audio inputs. The green color band on the rear of the TV indicates this connection. This row of five connectors is the one closer to you when you are standing behind your TV set.
11. **COMPONENT2 (YPb/CbPr/Cr with Audio L/R)** – Connect the secondary source for component video devices such as a DVD Player or set top box here. From left to right, use green for Y, blue for Pb (or Cb), red for Pr (or Cr), white for left audio and red for right audio inputs. The purple color band on the rear of the TV indicates this connection.
12. **AV1 IN** – Connect the primary source for composite video devices, such as a VCR or video game. Use the white and red connectors to connect the external audio from the same source. The yellow color band on the rear of the TV indicates this connection.
13. **AV2 IN** – Connect the secondary source for composite video devices, such as a VCR or video game. Use the white and red connectors to connect the external audio from the same source. The orange color band on the rear of the TV indicates this connection.
14. **DTV/TV** – Connect to an antenna or cable/digital cable for TV and Digital TV.*

* For digital TV stations in your area visit www.antennaweb.org.



1.4 VIZIO Universal Remote Control

The VIZIO Universal Remote Control is a comprehensive remote that can be used to control up to four different components. The remote control button functions are explained on the following pages.

SET – This button starts all programming of the Remote Control.

Remote LED – Blinks when the remote operates.

POWER – Press this button to turn the TV on from the Standby mode. Press it again to return to the Standby mode.

TV – This button has been pre-programmed to select the codes to operate the Vizio TV sets.

VCR – This button selects a programmed VCR

CABLE – This button selects a programmed cable TV set-top box or a satellite TV set-top box.

DVD – This button selects a programmed DVD player.

Number Button Pad – Use these buttons to select a channel or enter a password.

INPUT – This button allows the user to cycle through the inputs.

- **(Dash)/ ENTER** – When selecting a digital channel directly use this button for the separation of main and sub-channels. For example, channel 28-2 would be selected by the button sequence 2 8 ENTER 2.

CH (+ or -) – These buttons change the channels up or down.

LAST – This button recalls the previously viewed channel.

MUTE – This button turns the sound on and off.

VOL (+ or -) – These buttons turn the volume up or down.

MENU – Use this button for the On-Screen Display (OSD) menus.

INFO – This button displays the image and system information display.

GUIDE – This button displays program information. Note: this button is only functional for DTV.

EXIT – This button exits the On-Screen Display (OSD) menus.

 - These buttons navigate the On-Screen Display (OSD).

OK – Use this button to select your chosen option in On-Screen Display (OSD) menus.



WIDE – This button cycles through the available screen formats. The options for SD (Standard Definition 4:3) are Normal, Zoom and Panoramic. . The options for HD (High Definition 16:9) and RGB PC are Normal and Zoom.

SLEEP – This button allows the user to select the sleep options by adjusting the timer for 30, 60, 90 or 120 minutes.

MTS – This button will select the MTS options of Stereo, SAP or Mono in TV mode and alternate audio channels, where available, in DTV mode.

CC – This button will select the Closed Caption mode. The options are OFF, CC1, CC2, CC3 or CC4.

TV – Press this button to select TV.

AV – Repeated pressing of this button with switch between AV1, AV2 and AV3 inputs.

COMPONENT – Repeated pressing of this button with switch between Component 1 and Component 2 inputs.

HDMI – Repeated pressing of this button with switch between HDMI1, HDMI2 and HDMI3 inputs.

ZOOM (- and +) – Use these buttons to increase or decrease the size of the picture. Note that in the zoom mode parts of the picture will not be visible because they extend beyond the edges of the screen.

FREEZE – Press this button to “Freeze-Frame” the current screen. Press this button again the continue playing.

RGB – This button selects an RGB Analog component such as a PC.

PIP – Use this button to activate the Picture-In-Picture mode.

PIP CH (- and +) – These buttons are used to select the channels within the PIP screen when DTV/TV is the PIP input selected.

AUDIO – Press this button to switch the audio from the main screen to the sub-screen while in PIP mode.

PIP INPUT – Press the button to choose the PIP input. Note: The TV must be in PIP mode for this button to be functional. For additional information regarding the PIP options, see Picture-In-Picture (PIP) Mode on page 59.

PIP SIZE – Press this button to select the size of the PIP screen from one of the following: small, medium or large.

MODE – Use this button to change the picture mode from Custom, Standard, Movie and Game.

SWAP – While in PIP/POP mode; pressing SWAP will switch the displays from the main screen to the sub-screen or vice versa.



1.4.1 Insertion of Batteries in the Remote Control

Insert two AA batteries into the remote control. Make sure that you match the (+) and (-) symbols on the batteries with the (+) and (-) symbols inside the battery compartment. Re-attach the battery cover.

Precautionary Tips for Inserting the Batteries:

Only use the specified AA batteries.

Do not mix new and old batteries. This may result in cracking or leakage that may pose a fire risk or lead to personal injury.

Inserting the batteries incorrectly may also result in cracking or leakage that may pose a fire risk or lead to personal injury.

Dispose of the batteries in accordance with local laws and regulations.

Keep the batteries away from children and pets.



1.4.2 Remote Control Range

Point the remote control at the remote control sensor to transmit the commands.

Do not place any obstacles between the remote control and the receiver window.

The effective range of the remote control is approximately 30 feet (10 meters) from the front of the receiver window, 30° to the left and right, 20° up and down.

1.4.3 VIZIO Remote Control Precautions

The remote control should be kept dry and away from heat sources. Avoid humidity.

If the TV responds erratically to the remote control or does not respond at all, check the batteries. If the batteries are low or exhausted, replace them with fresh batteries.

When not using the remote control for a long period of time, remove the batteries.

Do not take the batteries apart, heat them, or throw them into a fire.

Do not subject the remote control to undue physical stress, such as striking or dropping it.

Do not attempt to clean the remote control with a volatile solvent. Wipe it with a clean, damp cloth.

1.4.4 Setting the Sleep Timer using Remote Control

The Sleep Timer lets you set a time delay to turn off the Plasma HDTV automatically.

To set the Sleep Timer using the remote control:

1. Press the SLEEP button on the remote control. The Sleep Timer appears in the center of your screen.
2. Press the SLEEP button one or more times to select the time you want. The choices are 30, 60, 90 or 120 minutes.





To turn off the sleep time using the remote control, press the SLEEP button repeatedly until Off appears on the screen.



Chapter 2 Connecting Equipment

2.1 Which Video Connection Should I Use?

The VIZIO VP50 has six different ways to connect your video equipment from a basic connection to the most advanced for digital displays.

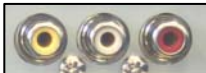
Connection Quality (type)	Connector	Rear Panel Color Codes	Description
Best (digital)		White	HDMI (High-Definition Multimedia Interface) - It is the first and only industry-supported, uncompressed, all-digital audio/video interface. HDMI provides an interface between any audio/video source, such as a set-top box, DVD player, or A/V receiver and an audio and/or video monitor, such as a digital television (DTV), over a single cable.
Best (digital) ----- Good (analog)		Black	DTV Coaxial RF. When used for MPEG2 encoded bit streams from ATSC broadcast programming, this input takes advantage of the High Definition content. ----- TV Coaxial RF. This is the connection for standard NTSC TV using antenna or cable.
Best (analog)		Blue	RGB PC (VGA) – This video input has separate red, green and blue color components. The signal carries horizontal and vertical sync information on the green signal. This is most commonly used for PC input.
Better (analog)		Green and Purple	Component - The video signal is separated into three signals, one containing the black-and-white information and the other two containing the color information. This enhancement over S-Video takes advantage of the superior picture provided by progressive scan DVD players and HDTV formats.
Good (analog)		Red	AV3 (S-Video) - The video signal is separated into two signals, one containing the black-and-white information and the other containing the color information. Separating the color in this way avoids 'cross color' effects where closely spaced black and white lines are erroneously displayed in color. It also enables text to be displayed more sharply.
Good (analog)		Yellow and Orange	Composite (AV1/AV2) - The complete video signal is carried through this single (yellow) pin connector. This is the most commonly used video connection.

Note: For more info refer to the Quick Start Guide



2.2 Connecting Coaxial (RF)

2.2.1 Using Your Antenna or Digital Cable for DTV / TV

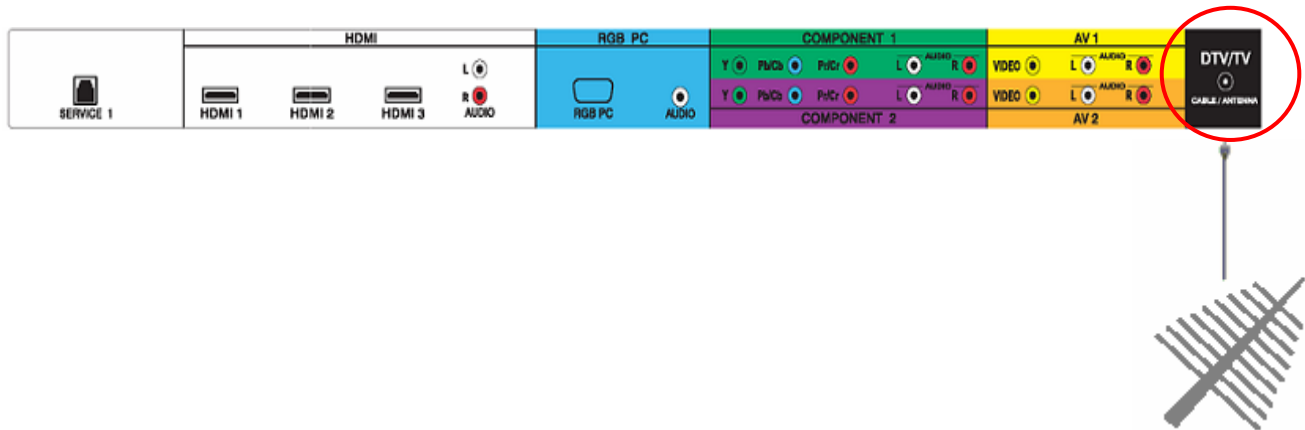

1. Turn off the power to the HDTV.
2. Connect the coaxial (RF) connector from your antenna or digital cable (out-of-the-wall, not from the Cable Box) to the DTV/TV CABLE/ANTENNA connector.
3. Turn on the power to the HDTV.
4. Select TV using the INPUT button on the remote or side of the HDTV, or directly by pressing the TV button on the Remote Control.

Note:

- a) Not all digital TV broadcasts are High Definition (HD). Refer to the program guides, or consult your cable, satellite or TV station operator.
- b) Digital broadcasts are not available in all areas. Refer to www.antennaweb.org for detailed information.
- c) Make sure the antenna and coaxial cable are correctly grounded.
- d) For Professional antenna installation contact us at www.VIZIO.com or call 1-888-VIZIOCE (1-888-849-4623).



2.2.2 Using the Antenna or Cable through your VCR

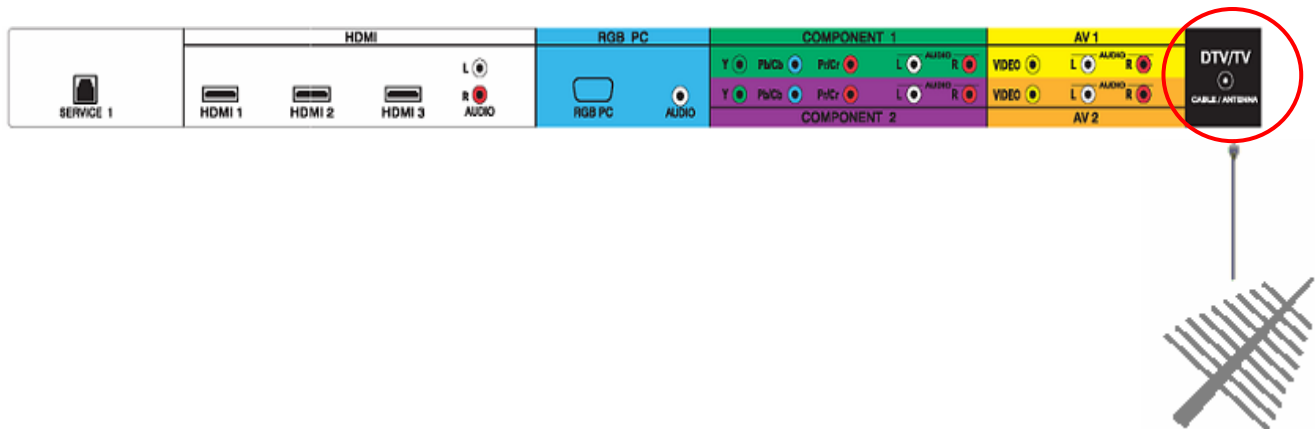

1. Turn off the power to the HDTV and VCR.
2. Connect the “Output to TV”, “RF Out” or “Antenna Out” connector on the rear of your VCR to the DTV/TV CABLE/ANTENNA connector at the rear of the HDTV.
3. Turn on the power to the HDTV and VCR.
4. Select TV using the INPUT button on the remote or side of the HDTV, or directly by pressing the TV button on the Remote Control.

Note: If you have an off-air antenna or cable TV, connect it to the “Antenna In” connector on the rear of your VCR.



2.3 Connecting Your HDTV Set-Top Box

2.3.1 Using HDMI

HDTV Set-Top Boxes that have a HDMI digital interface should be connected to the HDMI input of the Plasma HDTV for optimal results.

Note: To maintain the display quality, use a VIZIO certified HDMI cable that is 10 meters. See www.VIZIO.com or call 1-888-VIZIOCE (1-888-849-4623) for details.

Connecting your HDTV Set-Top Box (Best):

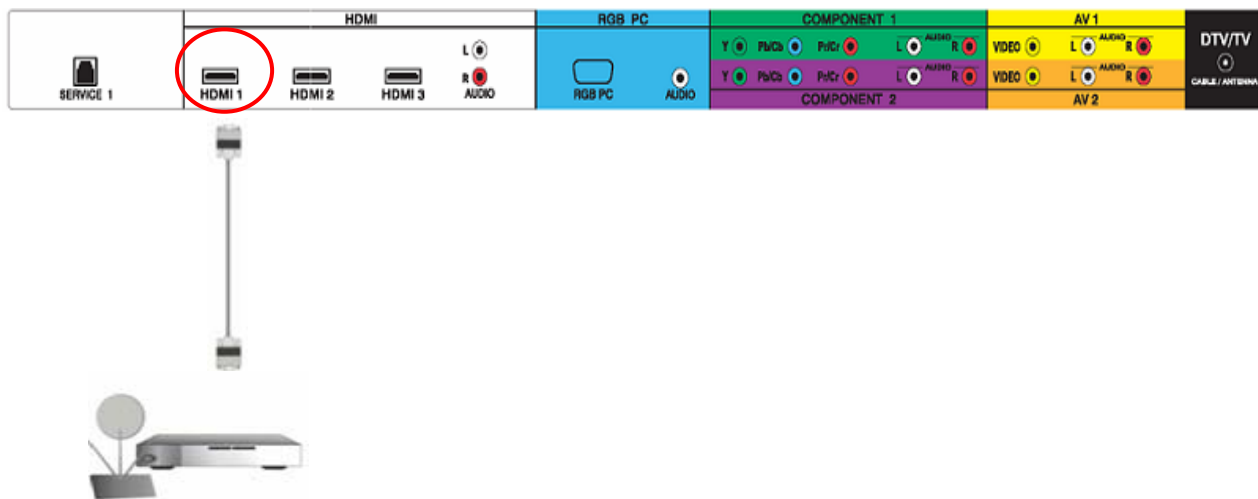

1. Turn off the power to the HDTV and HDTV Set-Top Box.
2. Connect a HDMI cable to the HDMI output of your HDTV Set-Top Box and the other end to the HDMI Input (white color area) at the rear of the HDTV.
3. Turn on the power to the HDTV and HDTV Set-Top Box.
4. Select HDMI using the INPUT button on the remote or side of the HDTV, or directly by pressing the HDMI button on the Remote Control.

Note:

- a) The HDMI input on the HDTV supports High-bandwidth Digital Content Protection (HDCP). HDCP encrypts the transmission between the video source and the digital display for added security and protection.
- b) Refer to your HDTV Set-Top Box user manual for more information about the video output requirements of the product or consult your cable or satellite operator.



For HDTV Set-Top Boxes with DVI:

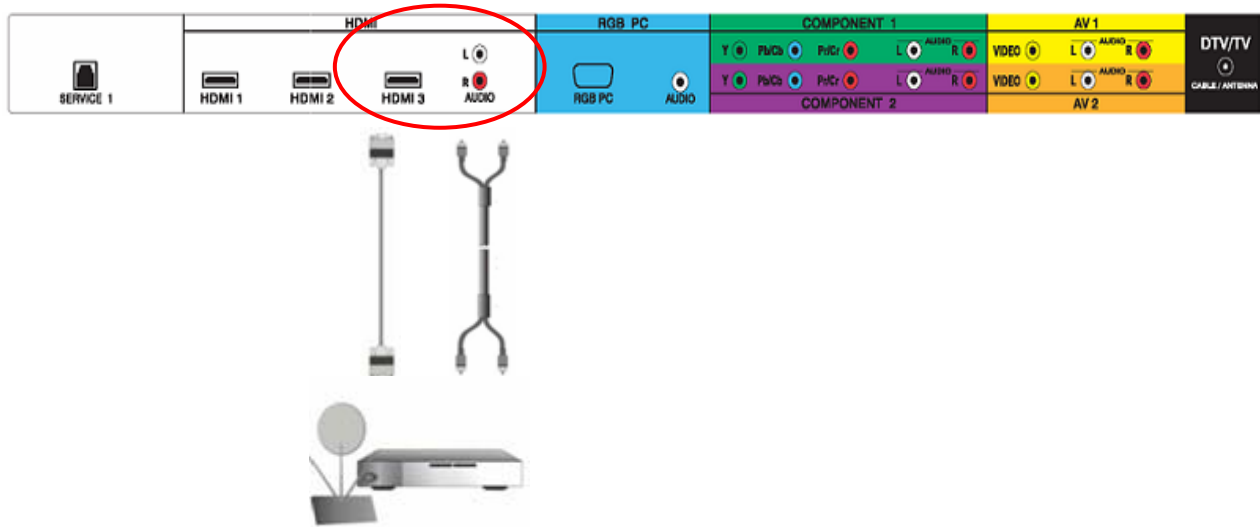

1. Turn off the power to the HDTV and HDTV Set-Top Box.
2. Using a HDMI-DVI cable, connect the DVI end to your HDTV Set-Top Box and the HDMI end to the HDMI Input (white color area) at the rear of the HDTV.
3. Using an audio cable (white and red connectors), connect the cable to the audio output connectors associated with the DVI output on your HDTV Set-Top Box and connect the other end to the audio connectors associated with the HDMI input (white area) at the rear of the HDTV.
4. Turn on the power to the HDTV and HDTV Set-Top Box.
5. Select HDMI using the INPUT button on the remote or side of the HDTV, or directly by pressing the HDMI button on the Remote Control.

Note: The HDMI Input is for HD Video and will only support 640x480 at 60Hz from a PC. Use the RGB PC input for a greater selection of PC formats.

Note:

- a) The HDMI input on the HDTV supports High-bandwidth Digital Content Protection (HDCP). HDCP encrypts the transmission between the video source and the digital display for added security and protection.
- b) Refer to your HDTV Set-Top Box user manual for more information about the video output requirements of the product or consult your cable or satellite operator.



2.3.2 Using Component Video

Connecting your HDTV Set-Top Box (Better):

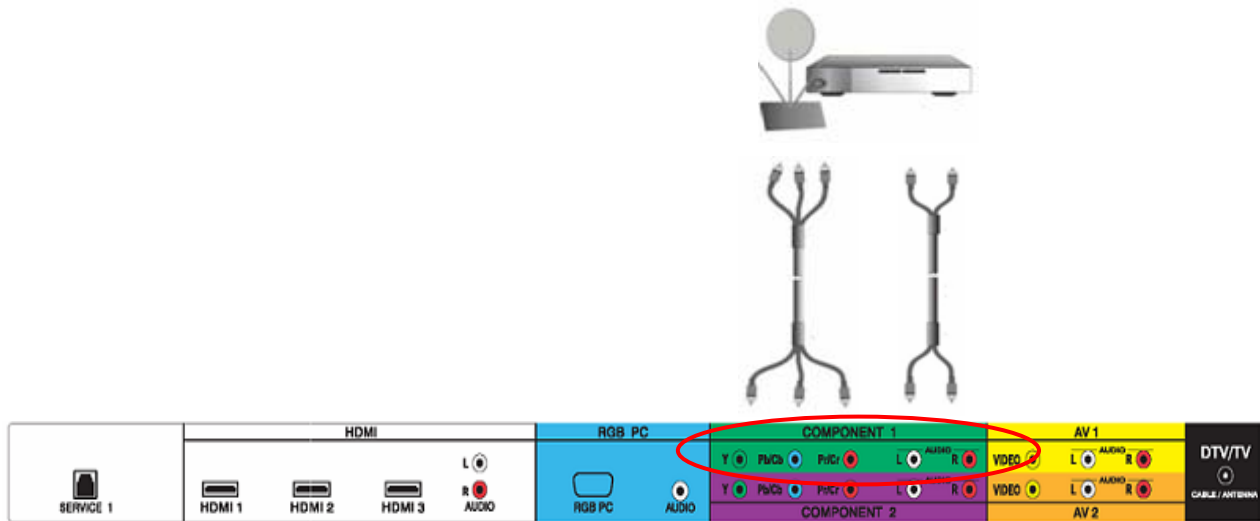

1. Turn off the power to the HDTV and HDTV Set-Top Box.
2. Connect the Y (green color) connector on your HDTV Set-Top Box to the corresponding Y (green color) connector in the Component 1 group (green color area - row of connectors nearest to you when viewing from the rear of the TV) at the rear of the HDTV.
3. Connect the Pb/Cb (blue color) connector on your HDTV Set-Top Box to the corresponding Pb/Cb (blue color) connector in the Component 1 group (green color area - row of connectors nearest to you when viewing from the rear of the TV) at the rear of the HDTV.
4. Connect the Pr/Cr (red color) connector on your HDTV Set-Top Box to the corresponding Pr /Cr (red color) connector in the Component 1 group (green color area - row of connectors nearest to you when viewing from the rear of the TV) at the rear of the HDTV.
5. Using an audio cable (white and red connectors), connect the cable to the audio output connectors associated with the Component output on your HDTV Set-Top Box and connect the other end to the audio connectors associated with the Component 1 input (green color area) at the rear of the HDTV.
6. Turn on the power to the HDTV and HDTV Set-Top Box.
7. Select Component 1 using the INPUT button on the remote or side of the HDTV, or directly by pressing the Component button on the Remote Control.

Note:

- a) If you are already using the Component 1 input for another component, or you do not want to use the Component 1 input for the Set-Top Box, you can connect the Set-Top Box to the Component 2 connections coded by the purple area.
- b) Refer to your HDTV Set-Top Box user manual for more information about the video output requirements of the product or consult your cable or satellite operator.



2.4 Connecting Your Basic Set-Top Box

2.4.1 Using Composite Video



1. Turn off the power to the HDTV and Set-Top Box.
2. Using the AV Cable, connect the Video (yellow color) connector on your Set-Top Box to the corresponding Video (yellow color) connector in the AV1 group (yellow color area) at the rear of the HDTV.
3. Using the white and red connectors, connect the cable to the audio output connectors associated with the Video output on your Set-Top Box and connect the other end to the audio connectors associated with the AV1 input (yellow color area) at the rear of the HDTV.
4. Turn on the power to the HDTV and Set-Top Box.
5. Select AV1 using the INPUT button on the remote or side of the HDTV, or directly by pressing the AV button on the Remote Control.



Note: If you are already using the AV1 input for another component, or you do not want to use the AV1 input for the Set-Top Box, you can connect the Set-Top Box to the AV2 connections coded by the orange area.

2.4.2 Using Coax (RF)

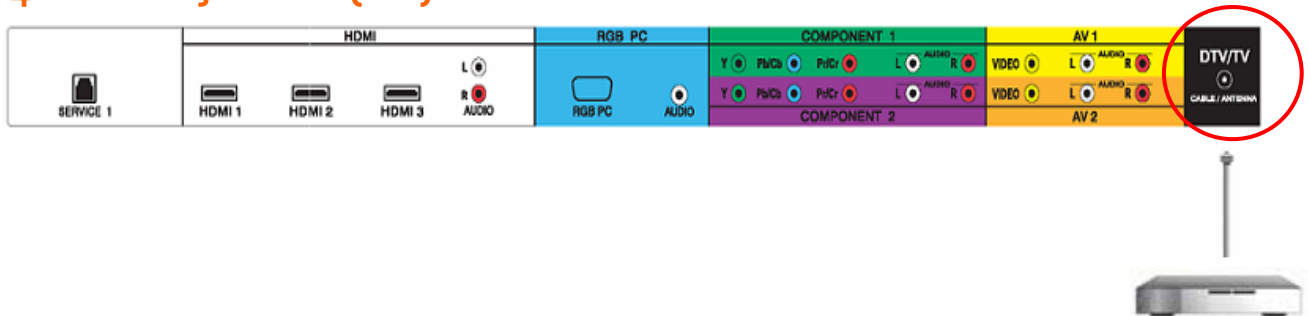

1. Turn off the power to the HDTV and Set-Top Box.
2. Using a Coax (RF) cable, connect one end to the TV OUT (RF) on your Set Top Box and the other end to the DTV/TV input at the rear of the HDTV.
3. Turn on the power to the HDTV and Set-Top Box.
4. Select TV using the INPUT button on the remote or side of the HDTV, or directly by pressing the TV button (below the WIDE button) on the Remote Control.

Note: Refer to your Set Top Box user manual for more information about selecting the video or RF output of the product.



2.5 Connecting Your DVD Player

You have several options for connecting your DVD player to your VP50 HDTV20A; HDMI, Component, AV (S-Video or Composite) inputs. Based on your configuration, you can decide which option is right for you.

2.5.1 Using HDMI

DVD players that have a digital interface such as HDMI (High Definition Multimedia Interface) should be connected to the HDMI input of the VIZIO VP50 for optimal results.

Note: To maintain the display quality, use a VIZIO certified HDMI cable available up to 10 meters. See www.VIZIO.com or call 1-888-VIZIOCE (1-888-849-4623) for details.

Connecting your DVD Player (Best):

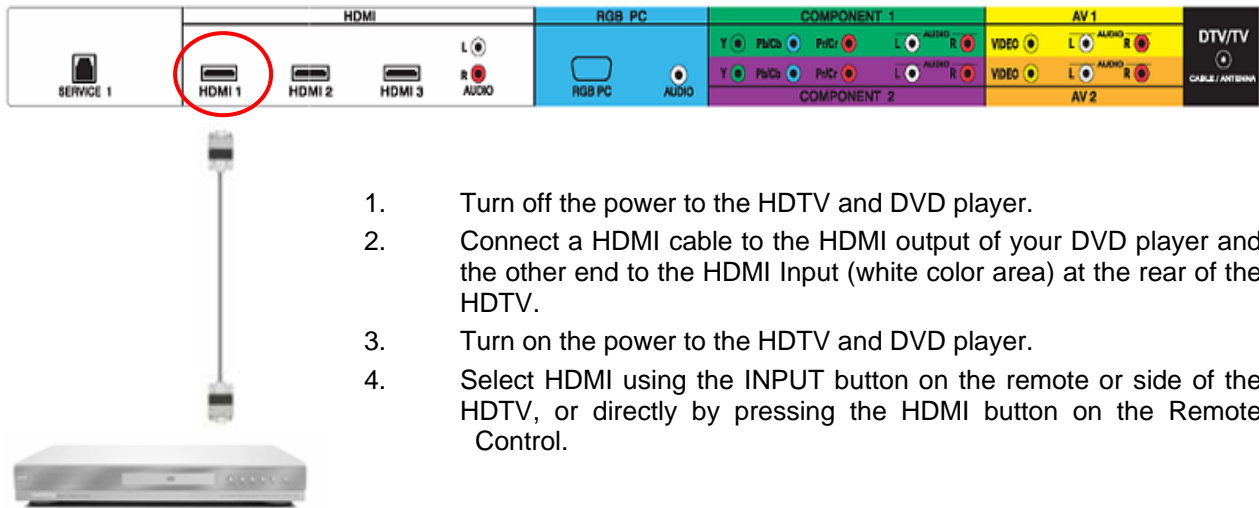

1. Turn off the power to the HDTV and DVD player.
2. Connect a HDMI cable to the HDMI output of your DVD player and the other end to the HDMI Input (white color area) at the rear of the HDTV.
3. Turn on the power to the HDTV and DVD player.
4. Select HDMI using the INPUT button on the remote or side of the HDTV, or directly by pressing the HDMI button on the Remote Control.



For DVD Players with DVI:

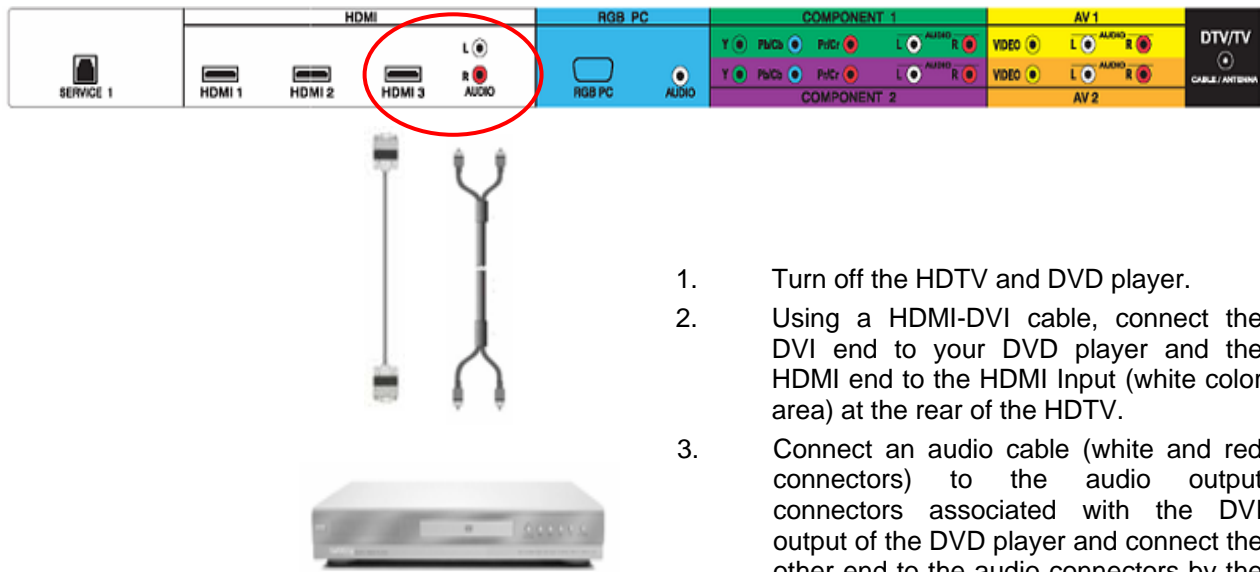

1. Turn off the HDTV and DVD player.
2. Using a HDMI-DVI cable, connect the DVI end to your DVD player and the HDMI end to the HDMI Input (white color area) at the rear of the HDTV.
3. Connect an audio cable (white and red connectors) to the audio output connectors associated with the DVI output of the DVD player and connect the other end to the audio connectors by the HDMI input (white area) on the HDTV.
4. Turn on the power to the HDTV and DVD player.
5. Select HDMI3 using the INPUT button on the remote or side of the HDTV, or directly by pressing the HDMI button on the Remote as many times as it takes to get you to HDMI3.

Note: Refer to your DVD player user manual for more information about the video output requirements of the product.



2.5.2 Using Component Video

Connecting your DVD Player (Better):

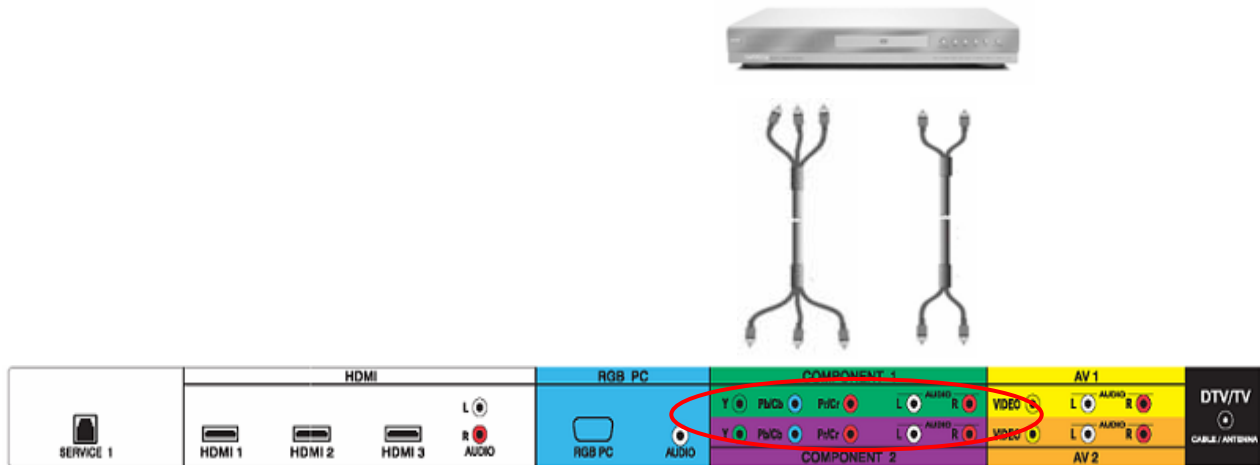

1. Turn off the power to the HDTV and DVD player.
2. Connect the Y (green color) connector on your DVD player to the corresponding Y (green color) connector in the Component 1 group (green color area - row of connectors nearest to you when viewing from the rear of the TV) at the rear of the HDTV.
3. Connect the Pb/Cb (blue color) connector on your DVD player to the corresponding Pb/Cb (blue color) connector in the Component 1 group (green color area - row of connectors nearest to you when viewing from the rear of the TV) at the rear of the HDTV.
4. Connect the Pr/Cr (red color) connector on your DVD player to the corresponding Pr/Cr (red color) connector in the Component 1 group (green color area - row of connectors nearest to you when viewing from the rear of the TV) at the rear of the HDTV.
5. Using an audio cable (white and red connectors), connect the cable to the audio output connectors associated with the Component output on your DVD player and connect the other end to the audio connectors associated with the Component 1 input (green color area) at the rear of the HDTV.
6. Turn on the power to the HDTV and DVD player.
7. Select Component using the INPUT button on the remote or side of the HDTV, or directly by pressing the Component button on the Remote Control.

Note:

- a) If you are already using the Component 1 input for another component, or you do not want to use the Component 1 input for the Set-Top Box, you can connect the Set-Top Box to the Component 2 connections coded by the purple area.
- b) Refer to your DVD player user manual for more information about the video output requirements of the product.



2.5.3 Using S-Video (AV3) Connecting your DVD Player (Good):

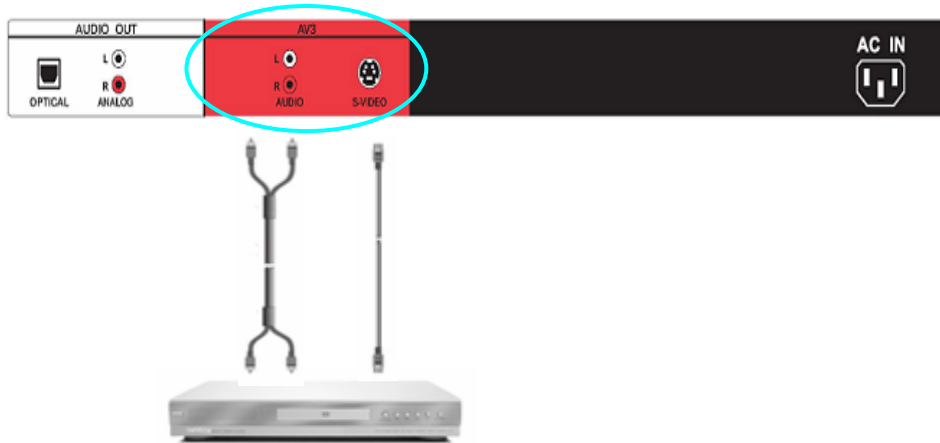

1. Turn off the power to the HDTV and DVD player.
2. Connect the S-Video jack on the rear of your DVD player to the S-Video jack in the AV3 input on the rear of the HDTV.
3. Connect an audio cable (white and red connectors) to the audio output connectors associated with the S-Video output on your DVD player and to the audio connectors associated with the AV3 input on the rear of the HDTV.
4. Turn on the power to the HDTV and DVD player.
5. Select AV3 using the INPUT button on the remote or side of the HDTV, or directly by pressing the AV button on the Remote Control as many times as needed to get AV3 (S-Video) display on the screen.

2.5.4 Using Composite (AV) Video Connecting your DVD Player (Good) :

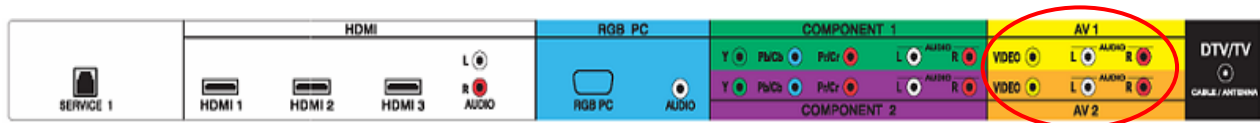

1. Turn off the power to the HDTV and DVD player.
2. Connect the Video (yellow color) connector on your DVD player to the Video (yellow color) connector to either AV1 (yellow color area) or AV2 (orange color area) group.
3. Connect the R (red color) and L (white color) audio connectors on your DVD player to the corresponding R (red color) and L (white color) audio input connectors in the AV2 group (orange color area).
4. Turn on the power to the HDTV and DVD Player.
5. Select AV1 or AV2 by using the INPUT button on the remote or side of the HDTV, or directly by pressing the AV button on the Remote Control.

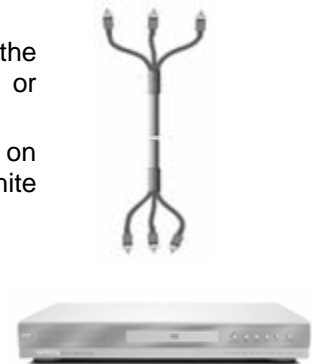

Note: Refer to your DVD player User's Manual for more information about the video output requirements of the product.



2.5.5 Connecting Your VCR or Video Camera

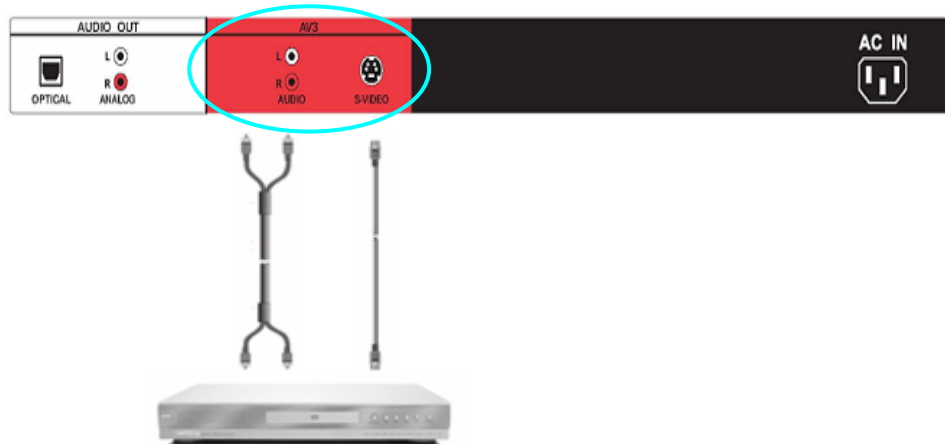



1. Turn off the HDTV and VCR or Video Camera.
2. Connect the S-Video jack on the rear of your VCR or Video Camera to the S-Video jack in the AV3 input on the HDTV.
3. Connect an audio cable (white and red connectors) cable to the audio output connectors associated with the S-Video output on your VCR or Video Camera and to the audio connectors associated with the AV3 input on the rear of the HDTV.
4. Turn on the power to the HDTV and VCR or Video Camera.
5. Select AV3 using the INPUT button on the remote or side of the HDTV, or directly by pressing the AV button on the Remote Control as many times as it takes to select AV3 (S-Video).

Note: Refer to your VCR or Video Camera user manual for more information about the video output requirements of the product.



2.6 Connecting an external Receiver/Amp



1. Turn off the power to the LCD HDTV and Receiver/Amp.
2. Using an audio cable (white and red connectors), connect the cable to the audio input connectors on the Receiver/Amp and connect the other end to the ANALOG OUT (white area) audio connectors at the rear of the LCD HDTV.
3. Turn on the power to the LCD HDTV and Receiver/Amp.
4. Then press the MENU button on the remote control to open the On-Screen Display (OSD) menu.
5. Press the  button on the remote control to select the Audio Adjust menu.
6. Press the  button on the remote control to select SPEAKERS.
7. Press the  button on the remote control to select OFF so that the sound from the LCD HDTV will now be routed through your Receiver/Amp system.



Press either the **MENU** key to return to the previous menu display or the **EXIT** key to return to your program if task has been completed.

Note:

- a) Refer to your Receiver/ Amp user manual to select the corresponding audio input.
- b) The audio output is not amplified and can not be connected directly to external speakers.

Optical Output of Audio received with HD Programs



If your sound system has a SPDIF (optical) digital audio input you can connect it to the optical DIGITAL AUDIO OUT (gray area) at the rear of the Plasma HDTV. This is active when receiving digital audio with the programs from the DTV/TV CABLE/ANTENNA input.



2.7 Connecting a PC Computer

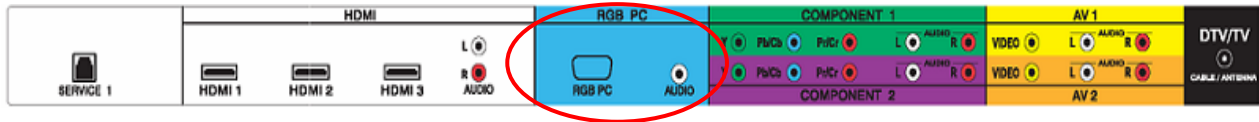

1. Turn off the power to the HDTV and PC Computer.
2. Connect a 15-pin D-Sub RGB (VGA) cable to the RGB output of your pc computer and the other end to the RGB PC input (blue area) at the rear of the HDTV.
3. Connect the Audio Out on your pc computer to the RGB PC Audio input (blue area) at the rear of the HDTV.
4. Turn on the HDTV and PC Computer.
5. Select RGB using the INPUT button on the remote or side of the HDTV, or directly by pressing the RGB button on the Remote Control.



Note:

- a) For the best picture quality when connecting a pc computer through RGB PC, set your pc computer timing mode to VESA 1366x768 at 60Hz. Please refer to the pc or graphic card's user guide for additional information on how to set the timing mode and the video output requirements of the product.
- b) A RGB (VGA) cable and stereo mini jack cable are not included and can be purchased at an electronics store.

2.7.1 Preset PC Resolutions

If connecting to a PC through the RGB PC input, set the TV timing mode to VESA 1366x768 at 60Hz for best picture quality (refer to the graphic card's user guide for questions on how to set this timing mode). Please see the table below for the factory preset resolutions.

Resolution	Refresh (Hz)	H.Freq (kHz)	V.Freq (Hz)	H.Sync	V.Sync	Pixel Freq (MHz)
640x480	60	31.5	59.94	N	N	25.175
640x480	75	37.5	75.00	N	N	31.500
720x400	70	31.46	70.08	N	P	28.320
800x600	60	37.9	60.317	P	P	40.000
800x600	75	46.9	75	P	P	49.500
800x600	85	53.7	85.06	P	P	56.250
1024x768	60	48.4	60.01	N	N	65.000
1024x768	75	60.0	75.03	P	P	78.750
*1366x768	60	47.7	60.00	P	N	85.500

NOTES: N = Negative, P = Positive, * = Primary (Native) Mode



Chapter 3 Setting Up to Watch Television

Before you start setting your TV set, please make sure that any cable, VCR, DVD, satellite or off-air antenna connections are secure. Also, verify that the power cord is plugged into a correctly grounded electrical outlet or surge protector.

For 'Preparing Your Plasma HDTV for Wall Mounting', see page 6.

3.1 Basic Plasma HDTV Start Up

1. **Connecting the Power Cable**
Connect the power cord to the power cord connector on the back of the HDTV, and then plug the power cord into an AC wall socket.
2. **Connect Audio and Video Cables to the HDTV**
(see pages 15 ~ 28 for detailed steps)
3. **Turning Power On**
Once all the components are connected, press the Power ON button on the side of the HDTV, or press the Power ON button on the remote control.
4. **Initial Setup**
After powering on the TV set, the Initial Setup screen will come up; please press the OK key on the remote control.





- a. The Language choice screen will be displayed; the default English option is highlighted. If you wish to change the OSD language to Español or Français, press the  button on the remote control to select the language you want.

Press the  button on the remote to go to the next screen.



Note: At this point, if a Set-Top Box from your Local Cable or Satellite Service Company or other equipment is been used; please press the EXIT key on the remote control and go to Step 5. If this is not your case, please continue at Step b.

- b. The Tuner screen will be displayed; default choice is Antenna. If you are using Cable (No Box) Service, press the  button on the remote control to highlight CABLE.

Press the  button on the remote to go to the next screen.

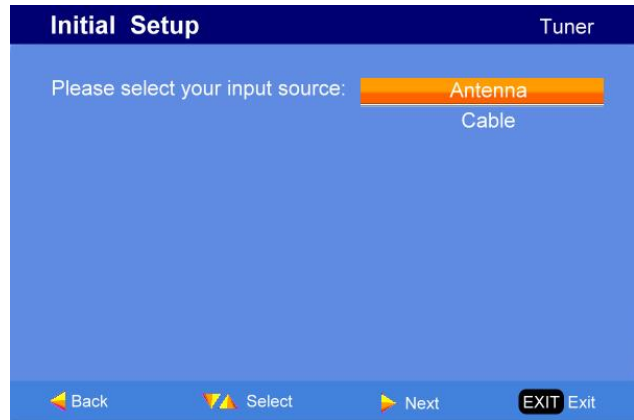

- c. The Channel Scan screen will be displayed; default choice is Scan. Press the OK button on the remote control to commence the search for available channels to be stored into memory.

If you do not want to scan for channels at this time, press the  button on the remote to highlight Skip Scan and then press the OK button.

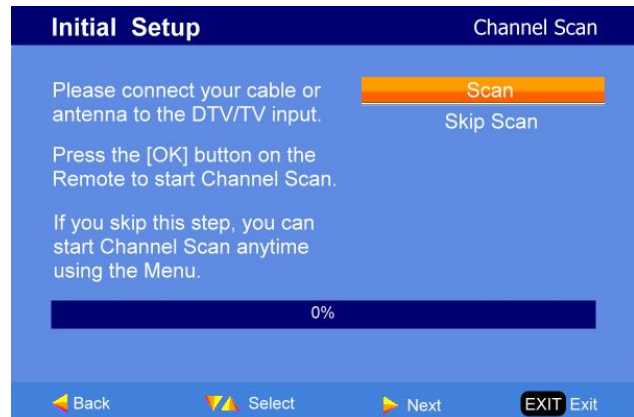

Note: If you select Skip Scan, next time that you decide to complete this procedure; you will need to select the TV as input (through the Input key) and then go through the Menu option to select the Tuner setup to get the option of scanning the channels again.



- d. The screen will now change to show the progress of the search for Analog (NTSC) and Digital (ATSC) channels.

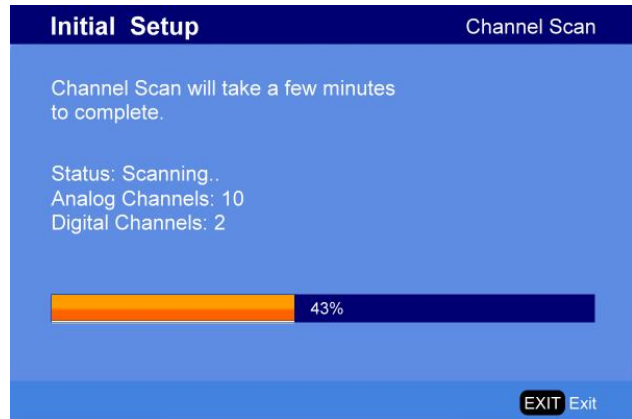

Note: DTV digital broadcast is not available in all areas. Refer to www.antennaweb.org to get information about availability in your area, type of antenna and in which direction to point your antenna. The channel availability through cable depends upon which channels your cable operator supplies in Clear QAM; consult your cable operator for more information.

- e. When finished, the Complete screen will be displayed to inform you that the HDTV has completed the Initial Setup.

Press the OK button on the remote control to exit and begin watching TV.

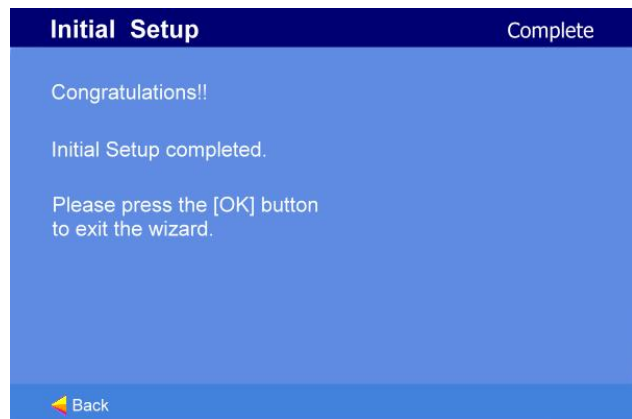

5. Select Input Source

Select the Input Source for the HDTV by pressing the INPUT button on the side of the TV or using the Input button on the remote control. Pressing this button will cycle you through the following options: TV, AV1, AV2, AV3 (S-Video), Component1, Component2, RGB, HDMI1, HDMI2 and HDMI3.

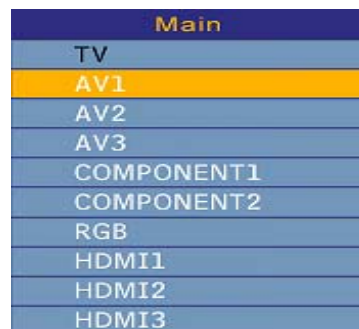

Now follow the procedure below to display channels from a different signal (External TV Tuner, VCR, Cable Box or Satellite Receiver) source, using different inputs at the back of you TV set.

- a. Select the correct input connection; RF (DTV/TV) connector, Composite (Yellow, Red and White) connectors, Component (Red, Green, Blue plus Red and White) connectors, HDMI



connectors or Separate-Video (S-Video) plus Red and White connectors (if applicable). Make the physical connection or hook up.

b. If you have an HD service you must use the HDMI (best) or Component connection.

Note: Composite (AV1 and AV2) and S-Video Cables can only be used for SD (480i) pictures.



c. Turn on your Cable Box, VCR, External TV Tuner or Satellite Receiver and you will see a picture on your TV set. If there is not picture, make sure you have selected the correct input on the TV set.

d. If the selected input is RF, you should be aware that the TV set needs to be on either channel 3 or channel 4 matching the channel which has been selected on the back of the VCR, Cable Box, External TV Tuner or Satellite Receiver; please refer to Owner or User's Manual of such equipment for details.

Note: The TV set will be displaying any television station or program selected by the Cable Box, VCR, External Tuner or Satellite Receiver. The TV set will not be able to change programs or channels; this is controlled by the equipment sending the signal. **If the service being used is the one which setup includes a box with two different outputs for two different (distant) rooms, then scanning channels would help you to find the signal. Be aware that the channel to be selected varies from provider to provider; meaning that, you may have to call your provider company so they could provide you the specific channel when using high definition made TV sets. Some examples of these channels are: 105, 106, 115 and 116.**

6. Fine Tuning your TV set for Home Use.

After completing Procedure 4 or Procedure 5; please follow the steps below to optimize your TV set display:

a. Press the **Menu** key to bring up the Menu display. Use either the  or  button to scroll to the Color Temperature option.

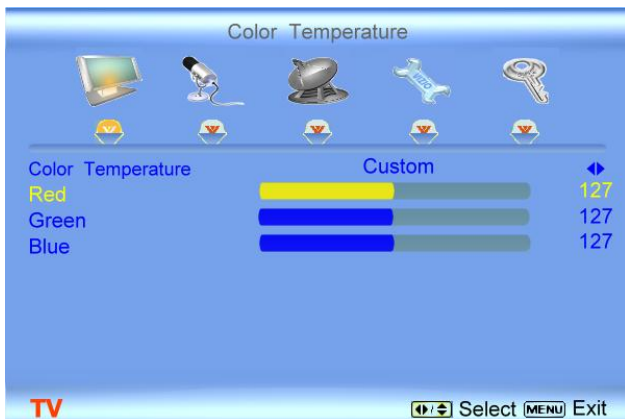
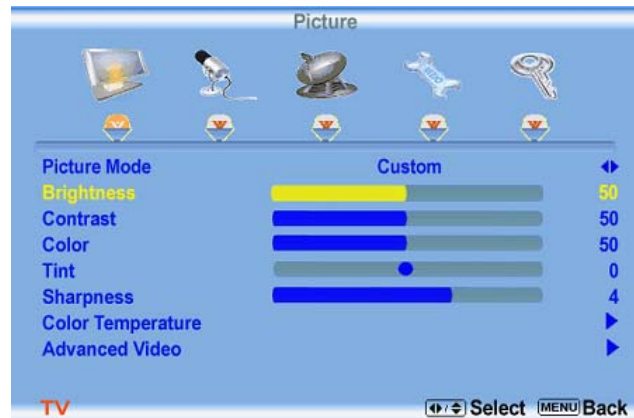

b. Press the  button to select it.

c. Press either  or  button to change setting to Normal, and then press the Menu key again to go back to previous screen.



d. Press either  or  button to select the Picture Mode option.

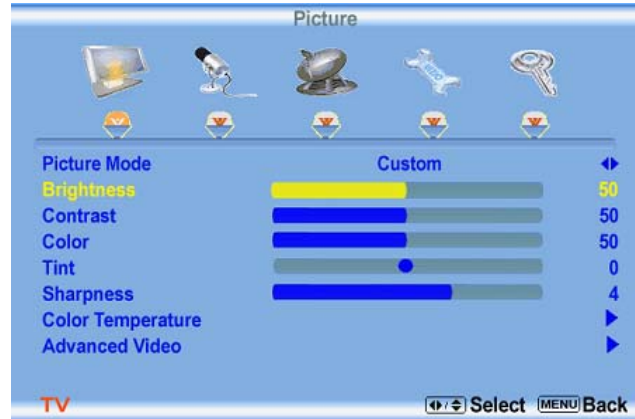

e. Press either  or  button to change the Picture Mode option to Standard.



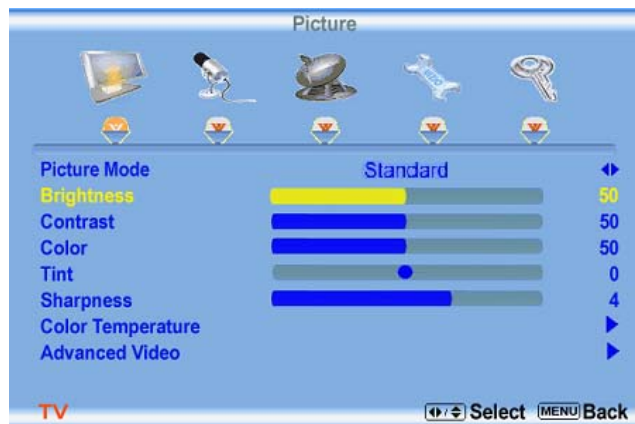

f. Press the **EXIT** key to exit the on screen display Menu.



Note: If Procedure 4 has been completed, you would like to do the following to ensure that the correct program times are shown when pressing the Guide key:

Press the Menu key, this will bring up the Picture menu again.

Pressing either  or  button scroll across to the icon showing the little satellite dish or antenna

The next screen will appear showing Time Zone; using either  or  button select it, and finally by pressing either  or  button choose the proper Time Zone of your area. Press **EXIT** key to exit on screen display Menu.

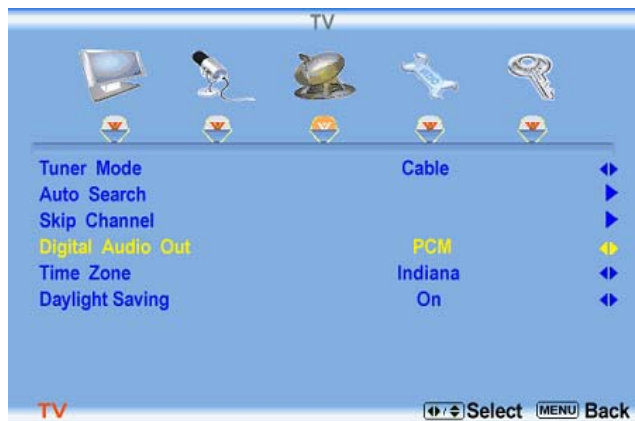

Your new TV set is now ready to automatically reproduce the best picture quality out of the input signal which is been fed into it. Enjoy your TV watching!!



3.2 Watching a TV Program

1. There are 3 options for selecting your programming:
 - a. If you are using an antenna or cable connected through the DTV/TV CABLE/ANTENNA input, you can select TV directly by pressing the TV button on the remote, or by pressing the INPUT button on the remote or on the side of the HDTV.
 - b. If you are watching broadcasts through a cable or satellite set-top box connected by an HDMI cable, select HDMI directly by pressing the HDMI button on the remote, or by pressing the INPUT button on the remote or on the side of the HDTV.
 - c. If you are watching broadcasts through a cable or satellite set-top box connected by a Component (YPbPr) cable, select Component directly by pressing the Component button on the remote, or by pressing the INPUT button on the remote or on the side of the HDTV.

Note: You should be able to see a picture. If you do not, make sure that all of the HDTV connections are secure and you have selected the correct video input source.

2. When using option 1a, press the Channel buttons on the remote or the CH+ or CH- buttons on the side of the HDTV to change the channel. Note: The Channel buttons, on the side of the HDTV and on the remote, control will not work if you are watching a program using HDMI, Component and AV inputs.

3.3 Adjusting Basic HDTV Settings



Volume

To increase the volume, press and hold the VOL+ or VOL- button on the side of the Plasma HDTV or remote control until the desired level is reached.

TV Channels

To step up or down through the available TV channels, press the CH+ or CH- button on the side of the HDTV or remote control once for the next or previous channel, or hold it depressed until the desired channel is reached. Note: Channel up and down will only operate in DTV and TV modes.

Wide

Using this feature, you can watch video content in different size modes on the HDTV. Press the WIDE button on the remote control to switch among the modes.

For more information see Section 4.17 - Understanding Viewing Modes, on page 58.

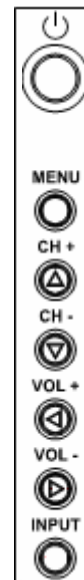

3.4 Program Information

Press the GUIDE button on the remote and program information for the channel you are watching will be displayed on the screen with the live program content in a small window in the lower left corner.



Press the or button to scroll up or down the channels. Each time you pause at a channel, the program list will update with the program schedule for the channel and the window will show the live program for that channel. Press the GUIDE button to exit this feature.

3.5 Information on HDTV Status

When you change TV channels or inputs, or press the INFO button on the remote, an Information Banner is displayed for a few seconds to tell you the status of the Plasma HDTV.

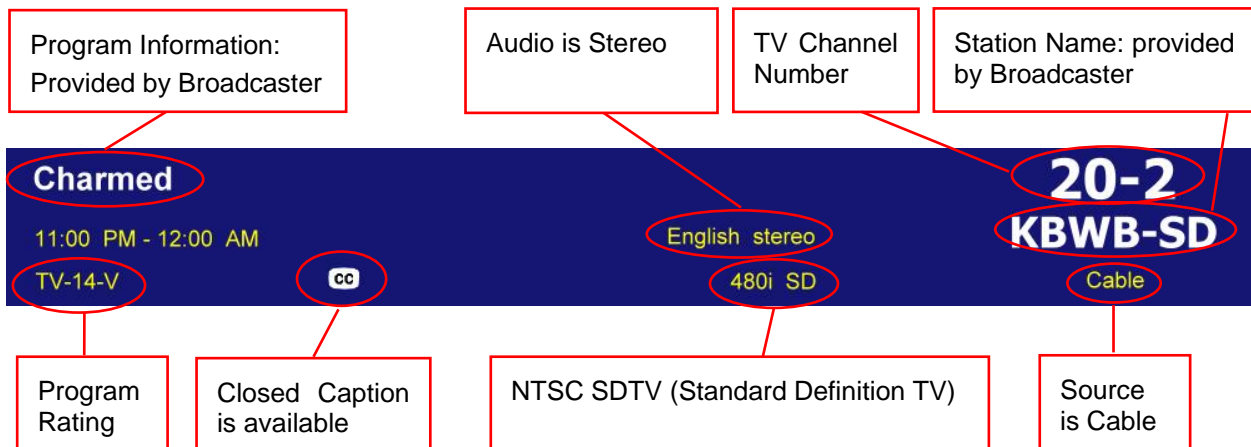



Chapter 4 Advanced Adjustment of HDTV

4.1 Using the On Screen Display (OSD)

The remote control or the control buttons on the right hand side of the TV can control all the function settings. The On Screen Display (OSD) allows you to adjust the save contrast, brightness and other settings. The TV will save changes made to the settings, even if the TV is turned off.



The OSD consists of several menu options: Picture Adjust, Audio Adjust, Setup, TV Tuner Setup and Parental Controls. The main menu options may vary depending on your selected input source.

Note: Some of the main menu options may have additional submenus, i.e. the TV Rating submenu for Parental Controls.

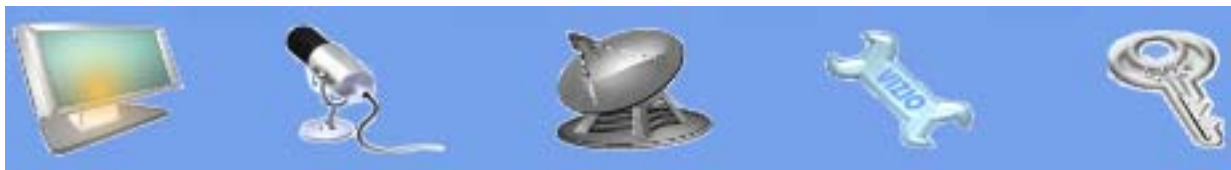
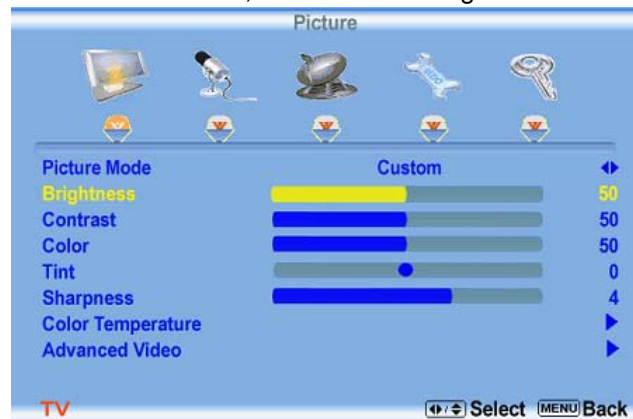
1. Press the MENU button on the remote control or the side of the TV and the Picture Adjust menu will be shown on the screen.
2. Press either the  or  button on the remote control or the VOL + or VOL – button on the side of the HDTV to select one of the other menu options.



Picture Adjust Audio Adjust TV Tuner Setup Setup Parental Controls

3. Once the menu option is displayed, press either the  or  button on the remote control or the CH + or CH – button on the side of the TV to select one of the items to adjust.



4. Press the  button on the remote control or the VOL – button on the side of the HDTV to begin adjustment of the item.
5. Press **OK** when finished.
6. Repeat steps 2 through 5 to adjust additional options within this menu.
7. Press either the **MENU** key to return to the previous menu display or the **EXIT** key to return to return to your program if task has been completed.



4.2 DTV / TV Input Picture Adjustment

4.2.1 Picture Mode

When the MENU button is pressed, the On Screen Display (OSD) appears on the PICTURE adjustment page. Press the  button to highlight the Picture Mode selection.

Use either the  or  button to choose from Custom, Standard, Movie and Game.

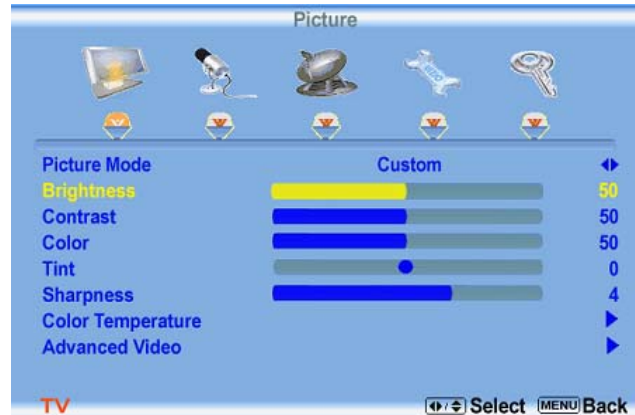

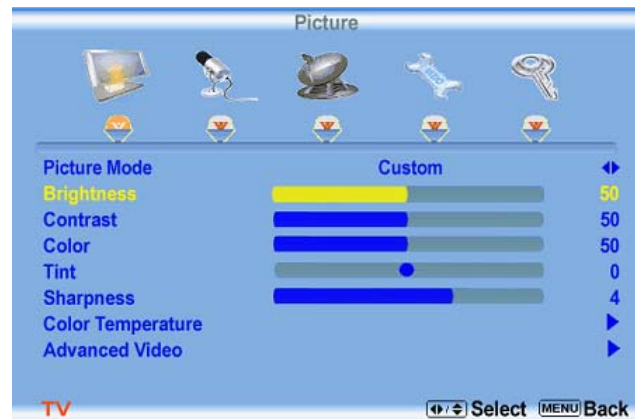

If Standard, Movie or Game is chosen for the Picture Mode, then the only Picture Adjustments available for you are for the Brightness and Advanced Video; the rest are preset.



4.2.2 Brightness

Press the  button to highlight the Brightness selection.

Press the  button to start adjusting the brightness and the menu page will disappear and be replaced by a small Brightness Indicator Bar so you can see the brightness level between the minimum and maximum available levels.

Use either the  or  button to adjust the level. The Brightness adjusts the black levels in the picture. If the brightness is too low you will not be

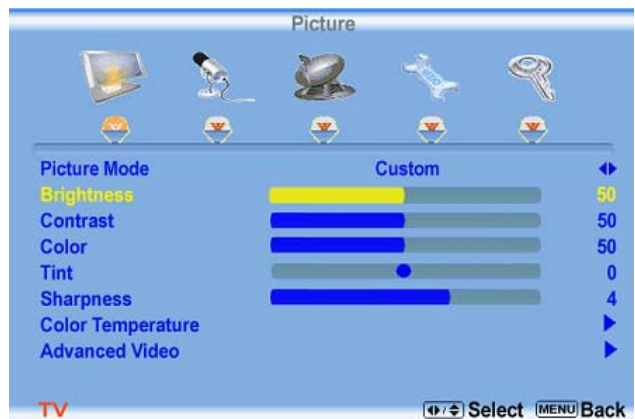

able to see the detail in darker parts of the picture and if the brightness is too high the picture will look washed out.

Press either the **MENU** key to return to the previous menu display or the **EXIT** key to return to return to your program if task has been completed.



4.2.3 Contrast

Press the  button to highlight the Contrast selection.

Press the  button to start adjusting the contrast and the menu page will disappear and be replaced by a small Contrast Indicator Bar so you can see the contrast level between the minimum and maximum available levels.

Use either the  or  button to adjust the level.



The Contrast adjusts the white levels in the picture. If the contrast is too low the picture will look washed out and if the contrast is too high you will not be able to see any detail in the bright parts of a picture.

Press either the **MENU** key to return to the previous menu display or the **EXIT** key to return to return to your program if task has been completed.

4.2.4 Color

Press the  button to highlight the Color selection.

Press the  button to start adjusting the color and the menu page will disappear and be replaced by a small Color Indicator Bar so you can see the color level between the minimum and maximum available levels.

Use either the  or  button to adjust the level.



The Color adjusts the amount of color in the picture.

Press either the **MENU** key to return to the previous menu display or the **EXIT** key to return to return to your program if task has been completed.

4.2.5 Tint

Press the  button to highlight the Tint selection.

Press the  button to start adjusting the tint and the menu page will disappear and be replaced by a small Tint Indicator Bar so you can see the tint adjustment to the left or right of the nominal position.

Use either the  or  button to adjust the level.



The Tint adjusts the hue of the picture. The easiest way to set tint is to look at flesh tones and adjust for a realistic appearance. In most cases, the default middle position is correct. If people's faces look too orange try reducing the level of color first as the case of this is often too much color.

Press either the **MENU** key to return to the previous menu display or the **EXIT** key to return to return to your program if task has been completed.



4.2.6 Sharpness

Press the  button to highlight the Sharpness selection.

Press the  button to start adjusting the sharpness and the menu page will disappear and be replaced by a small Sharpness Indicator Bar so you can see the sharpness level between the minimum and maximum available levels.

Use either the  or  button to adjust the level.





The Sharpness adjusts the sharpness of the picture.

Press either the **MENU** key to return to the previous menu display or the **EXIT** key to return to return to your program if task has been completed.

4.2.7 Color Temperature

Press the  button to highlight the option for Color Temperature selection.

The default is COOL; this is the 9300K setting.

Press the  or  button if you want to choose the Normal or Custom option.

Press either the **MENU** key to return to the previous menu display or the **EXIT** key to return to your program if task has been completed.

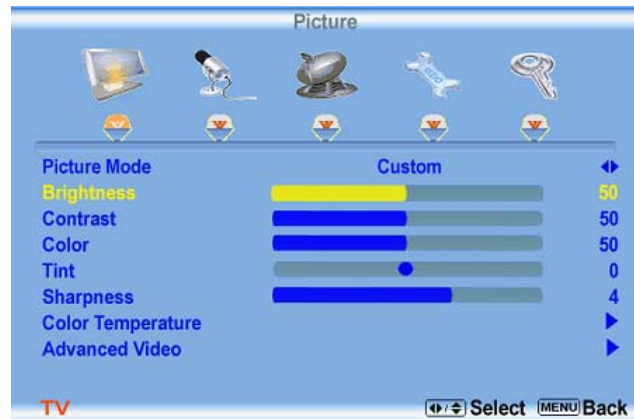

If you choose the Custom option, then a new menu will be displayed showing the primary color items, Red, Green and Blue.

Press the  button to highlight the color you wish to adjust.

Press the  button to start adjusting the color and the menu page will disappear and be replaced by a small Color (Red, Green or Blue) Indicator Bar as before.

Use either the  or  button to adjust the color.

Press the **OK** button when finished. Repeat the procedure to adjust the other colors if desired.

Press either the **MENU** key to return to the previous menu display or the **EXIT** key to return to your program if task has been completed.





4.2.8 Advanced Video

Press the  button to highlight the option for Advanced Video selection and press the OK button. A new menu will be displayed showing the advanced functions available for fine tuning of the picture.





DNR

Press the  button to highlight DNR (Dynamic Noise Reduction). Use this feature to diminish picture artifacts caused by the digitizing of image motion content that may be present in the picture. Press either the  or  button to choose from the Off, Low, Medium or Strong setting.



Press either the **MENU** key to return to the previous menu display or the **EXIT** key to return to your program if task has been completed.

Black Level Extender

Press the  button to highlight Black Level Extender. Use this feature to increase the picture reproduction performance in the dark areas of the picture. Press either the  or  button to turn this feature On or Off.

Press either the **MENU** key to return to the previous menu display or the **EXIT** key to return to your program if task has been completed.

White Peak Limiter

Press the  button to highlight White Peak Limiter. Use this feature to limit excessive white in bright areas of the picture, caused by a lower sync level for a channel being received from the antenna or cable. Press either the  or  button to turn this feature On or Off.

Press either the **MENU** key to return to the previous menu display or the **EXIT** key to return to your program if task has been completed.

CTI

Press the  button to highlight CTI (Color Transient Improvement). This feature can be used to reduce the time taken to transition from one color to another. The effect will be seen as sharpening the border between colors.

Press either the  or  button to choose from the Off, Low, Medium or Strong setting.

Press either the **MENU** key to return to the previous menu display or the **EXIT** key to return to your program if task has been completed.



Flesh Tone

Press the  button to highlight Flesh Tone. In some cases, activation of this feature can result in a more pleasing production of sky and flesh color.

Press either the  or  button to turn this feature On or Off.

Press either the **MENU** key to return to the previous menu display or the **EXIT** key to return to return to your program if task has been completed.

Adaptive Luma

Press the  button to highlight Adaptive Luma. Large areas of darkness in a picture will result in a lower Average Picture Level (APL) and the overall picture will look too dark; activation of this feature will raise the APL to counteract this effect.

Press either the  or  button to turn this feature On or Off.

Press either the **MENU** key to return to the previous menu display or the **EXIT** key to return to your program if task has been completed.





4.3 DTV / TV Input Audio Adjustment

4.3.1 Volume

When the MENU button is pressed, the On Screen Display (OSD) appears on the PICTURE adjustment page. Press the  button to display the AUDIO ADJUST page.



Press the  button to highlight the Volume selection.

Press the  button to start adjusting the volume and the menu page will disappear and be replaced by a small Volume Indicator Bar so you can see the volume level between the zero and maximum available levels. Use either the  or  button to adjust the level.



The Volume Indicator Bar will also appear when watching a program on your TV is the Volume button on the remote or the side of the TV is pressed.



Press either the **MENU** key to return to the previous menu display or the **EXIT** key to return to your program if task has been completed.

4.3.2 Bass

Press the  button to highlight the Bass selection.

Press the  button to start adjusting the bass and the menu page will disappear and be replaced by a small Bass Indicator Bar, as before, so you can see the bass level between the zero and maximum available levels.



Use either the  or  button to adjust for bass boost or attenuation.

Press either the **MENU** key to return to the previous menu display or the **EXIT** key to return to your program if task has been completed.





4.3.3 Treble

Press the  button to highlight the Treble selection.

Press the  button to start adjusting the treble and the menu page will disappear and be replaced by a small Treble Indicator Bar, as before, so you can see the treble level between the zero and maximum available levels.



Use either the  or  button to adjust for treble boost or attenuation.

Press either the **MENU** key to return to the previous menu display or the **EXIT** key to return to your program if task has been completed.

4.3.4 Balance

Press the  button to highlight the Balance selection.

Press the  button to start adjusting the balance and the menu page will disappear and be replaced by a small Balance Indicator Bar, as before, so you can see the balance adjustment to the left or right of the nominal position.



Use either the  or  button to adjust the left/right balance.

Press either the **MENU** key to return to the previous menu display or the **EXIT** key to return to your program if task has been completed.

4.3.5 Surround

Press the  button to highlight the Surround selection.

Press the  button to select for the simulated surround sound feature to be On or Off.

Press either the **MENU** key to return to the previous menu display or the **EXIT** key to return to your program if task has been completed.

4.3.6 Speakers

Press the  button to highlight the Speakers selection.

Press the  button to turn the internal speakers On or Off. You may want to turn-off the internal speakers when listening to the audio through your Home Theatre System.

Press either the **MENU** key to return to the previous menu display or the **EXIT** key to return to your program if task has been completed.





4.4 DTV / TV Tuner Setup

When you first used your VP50 you will have setup your TV for DTV / TV channels using the Initial Setup screens. If you did not do this or if your setup has changed, you can do this from the TV TUNER SETUP menu.

4.4.1 Tuner Mode

When the MENU button is pressed, the On Screen Display (OSD) appears on the PICTURE adjustment page. Press the  button to display the TV page.

Press the  button to highlight the Tuner Mode selection.

Press the  button to choose Cable or Air (Antenna) depending upon which equipment you have attached to the DTV / TV Input.

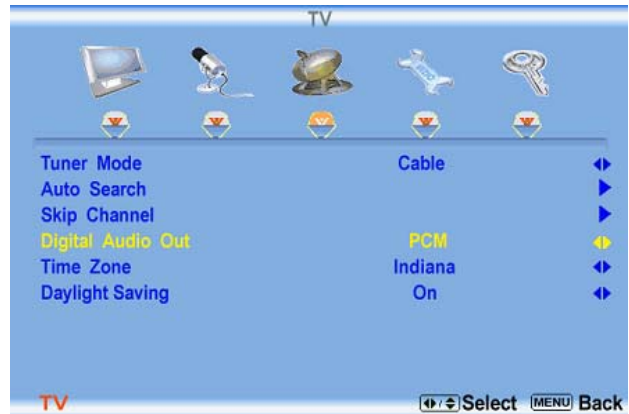

4.4.2 Auto Search

Press the  button to highlight the Auto Search selection.



Press the  button to Auto Search for TV channels available. The TV will automatically search for analog and digital channels.



4.4.3 Skip Channel



After the TV has stored all of the available DTV channels in memory you will find that some channels will be too weak to watch comfortably or they may be channels you do not want to see. Select the channel you wish to remove.

Press the MENU and  buttons to open the TV TUNER SETUP menu.

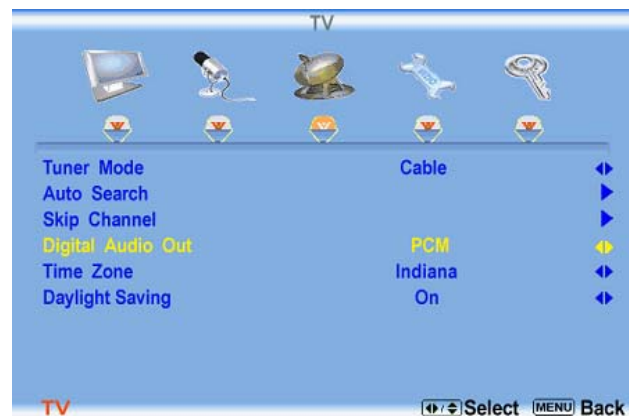
Press the  button to highlight SKIP CHANNEL. Press the  button to select this channel to be skipped when using the CH+ or CH- button. You will still be able to select this channel using the number buttons on the remote control.



4.4.4 Digital Audio Out

Press the  button to select this feature. The options are Off, Dolby Digital and PCM. Press the  or  button to select the desired output when an external sound system is used.

Press either the **MENU** key to return to the previous menu display or the **EXIT** key to return to your program if task has been completed



4.4.5 Time Zone

Setting the correct Time Zone for your area will ensure that the correct program times are shown after pressing the GUIDE button on the remote control.

Press the  button to highlight the Time Zone selection.

Press either the  or  button to select your area.

Press either the **MENU** key to return to the previous menu display or the **EXIT** key to return to your program if task has been completed

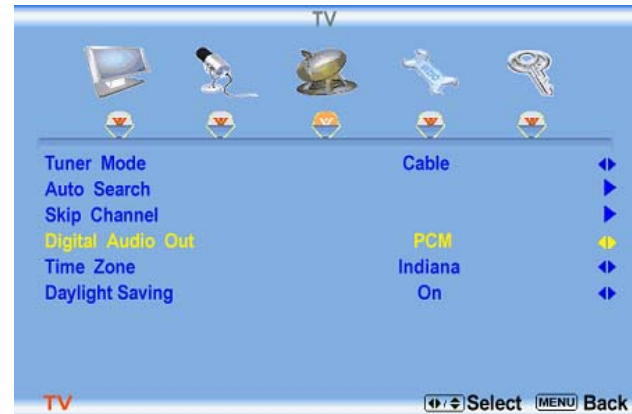

4.4.6 Daylight Saving

As for Time Zone, setting the daylight saving time for your area will ensure that the correct program times are shown after pressing the GUIDE button on the remote control.

Press the  button to highlight the Daylight Saving selection.

Press the  button to select On or Off.

Press either the **MENU** key to return to the previous menu display or the **EXIT** key to return to your program if task has been completed



4.5 DTV / TV Input Setup

4.5.1 Language

When the MENU button is pressed, the On Screen Display (OSD) appears on the PICTURE adjustment page. Press the  button until the SETUP page is displayed.

NOTE: Pressing the EXIT key either at any time during or after completing a feature's setup; will take you out of On Screen Display menu. If it is done during the setup, the changes will be aborted and the feature will remain at the same value or original condition in which it was found.



Press the  button to highlight the Language selection. The default is English.

Press the  button to select Español or Français.



Press either the **MENU** key to return to the previous menu display or the **EXIT** key to return to your program if task has been completed.

4.5.2 PIP (Picture-in-Picture)

Picture-in-Picture is a feature which allows you to watch two different signal inputs simultaneously, when selected.

Press the  button and highlight the option.

Press the  button to activate the PIP feature, which will bring up a display showing Style.

Press either the  or  button to select it to be either PIP, POP or OFF.

Press either the **MENU** key to return to the previous menu display or the **EXIT** key to return to your program if task has been completed.

If PIP is selected, then you will have the options of selecting the Input (Refer to PIP mode on page 60 of this manual; for different combinations), Size (The size of the little box to watch the second signal) and Position (Where you want to place the little box with the second signal).

If POP (Regularly called Picture-by-Picture) is selected, you will only have the option to select the Input as the screen will display the two different signals side by side; each one occupying half of the screen.

Using the **AUDIO** key allows you to select which audio signal to listen to; either the audio signal of the main screen or the audio signal of the sub-screen.

4.5.3 Sleep Timer

Press the  button to highlight the Sleep Timer selection.

Press the  button to select the timer to turn-off the TV in 30, 60, 90 or 120 minutes.

Press either the **MENU** key to return to the previous menu display or the **EXIT** key to return to your program if task has been completed



4.5.4 Analog Closed Caption

When watching regular analog (NTSC) TV, the Analog CC feature is available in the Setup menu.

Press the  button to highlight the Analog CC selection.

Press the  button to select CC1, CC2, CC3 or CC4.

Press either the **MENU** key to return to the previous menu display or the **EXIT** key to return to your program if task has been completed

Closed Caption for regular TV is usually CC1 or CC2.



4.5.5 Digital Closed Caption

When watching DTV, the Digital CC feature is available in the Setup menu.

Press the  button to highlight the Digital CC selection.

Press the  button to select Service 1.

Press either the **MENU** key to return to the previous menu display or the **EXIT** key to return to your program if task has been completed

4.5.6 Digital Closed Caption Style

When selecting Digital Closed Caption you are also able to customize the look of the Closed Caption.

Press the  button to highlight the Digital CC Style selection. The default is Broadcast which means the style is the same as the broadcast channel has chosen for transmission.

Press the  button to select Custom.

The Custom page allows you to change the font size and color, the background color, and the transparency of the Closed Caption.

Press either the **MENU** key to return to the previous menu display or the **EXIT** key to return to your program if task has been completed.





4.5.7 Image Cleaner

This feature may allow ghosts of previous images to be removed.

Press the  button to highlight the Image Cleaner option.

Press the  button to select it.

Press the  or  button to turn this feature On. Press the **OK** key to run it.

It usually takes 60 or more minutes for this feature to run a full cycle, and then the TV will turn off automatically without any supervision.

Note: Prolonged display of stationary images (such as on a video game or a computer or a still picture) will cause them to remain on the screen. Higher brightness and contrast levels will make the panel more susceptible to image retention. To minimize image retention, reduce the degree of brightness and contrast of the screen when displaying a still image. Image Cleaner will not remove images that have been displayed for too long. Image sticking is not covered under standard warranty.

4.5.8 Reset All Settings

Press the  button to highlight the Reset All Settings selection.

Press the  button to reset the TV to the default factory settings.

Press either the **MENU** key to return to the previous menu display or the **EXIT** key to return to your program if task has been completed.

Note: This does NOT reset the Parental Control Password.



4.6 DTV / TV Input Parental Control

4.6.1 Channel Block

If you want to restrict certain channel and program viewing, you can do this by turning on the Parental Control. Selected programs, movies and channels can then be made available only after an authorized password has been entered and accepted by the TV.

When the MENU button is pressed, the On Screen Display (OSD) appears on the PICTURE adjustment page. Press the  button to display the PARENTAL page.

The Password must be entered before the TV will continue with Parental settings. The default password set in the factory is 0 0 0 0. If you are going to use the Parental Control feature you should change the password.

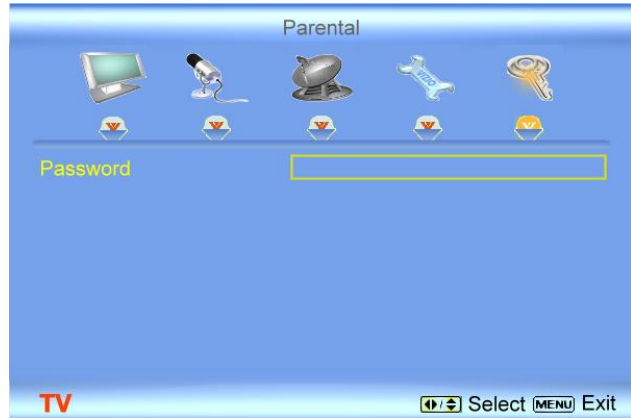

Note: Make sure you write down and store the new password in a secure place. The Reset All Settings feature (see page 48) does NOT reset the password.

Press the  button to highlight the Channel Block selection.

Press the  button to turn it on or off.

Press either the **MENU** key to return to the previous menu display or the **EXIT** key to return to your program if task has been completed.



4.6.2 TV Rating

Follow the procedure in Section 4.6.1 to display the Parental menu and then press the  button to highlight the TV Rating selection.

Press the  button and the Block TV Rating panel will be displayed.

In the Block TV Rating panel you can customize the program blocking of the following TV ratings:

- Y – All children
- Y7 – Older children
- G – General audience
- PG – Guidance suggested
- 14 – Strongly cautioned
- MA – Mature audience

You can also customize the TV ratings for the following content:

- A – Sexual dialog
- D – Sexual dialog
- L – Adult language
- S – Sexual situations
- V - Violence
- FV – Fantasy violence

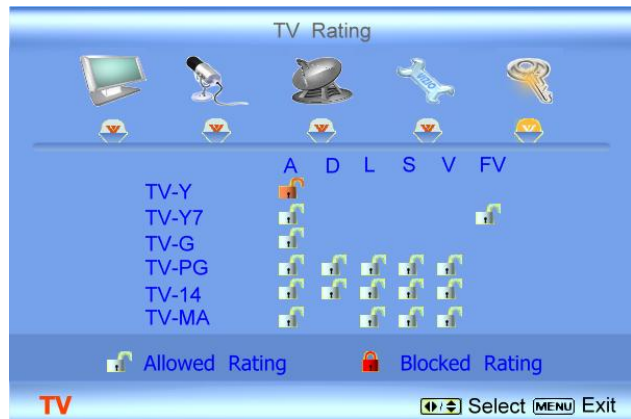

Press the  or  button to navigate through the TV rating options.

Press the  button to block (locked) or allow (unlocked).

Press either the **MENU** key to return to the previous menu display or the **EXIT** key to return to your program if task has been completed.



4.6.3 Movie Rating

Press the button to highlight the Movie Rating selection.

Press the button and the Block Movie Rating panel will be displayed.

In the Block Movie Rating panel you can customize the program blocking of the following Movie ratings:

- G – General audience
- PG – Parental guidance suggested
- PG-13 – Recommended for children 13 years of age or older
- R – Mature audience
- NC-17 – No one under 17 years of age
- X – No one under 17 years of age



Press the or button to navigate through the Movie rating options.

Press the button to block (locked) or allow (unlocked).

Press either the **MENU** key to return to the previous menu display or the **EXIT** key to return to your program if task has been completed.

4.6.4 Blocked Unrated Programming

Follow the procedure in Section 4.6.1 to display the Parental menu and then press the button to highlight the Block Unrated TV selection.

Press the button to turn-on or turn-off the blocking of programming that does not have a rating.

Press either the **MENU** key to return to the previous menu display or the **EXIT** key to return to your program if task has been completed.



4.6.5 Change the Password



Press the button to highlight the Access Code Edit selection.

Press the button and the new Password panel will be displayed.

Enter the new, 4-digit password using the number buttons on the remote. Enter it a second time to confirm you entered it correctly.

Press either the **MENU** key to return to the previous menu display or the **EXIT** key to return to your program if task has been completed.

Note: Make sure you write down and store the new password in a secure place. The Reset

All Settings feature (see page 48) does NOT reset the password.



4.7 HDMI Input Picture Adjustment

The Picture Adjust menu operates in the same way for the HDMI Input as for the DTV / TV input in section 4.2. The menu difference is that there is no icon along the top for DTV / TV or Parental Control adjustments.

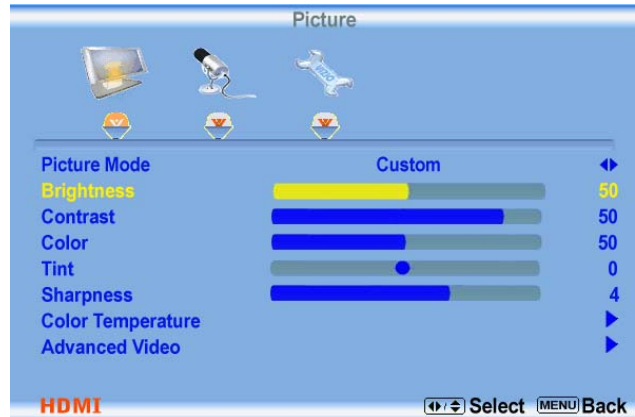

4.8 HDMI Input Audio Adjustment

The Audio Adjust menu operates in the same way for the HDMI Input as for the DTV / TV input in section 4.3. The menu difference is that there is no icon along the top for DTV / TV or Parental Control adjustments.

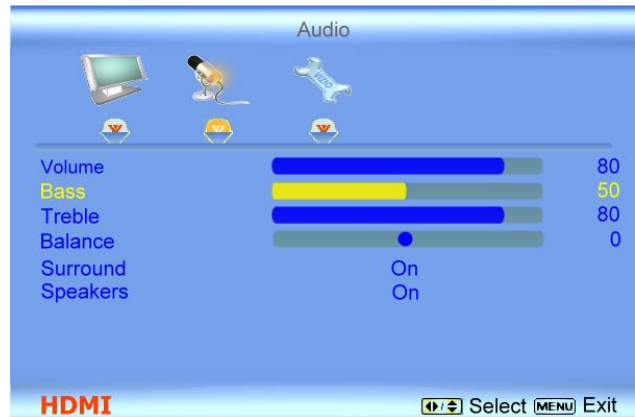

4.9 HDMI Input Setup

The Setup menu operates in the same way for the HDMI Input as for the DTV/TV input in section 4.5. The menu difference is that there is no icon along the top for DTV/TV or Parental Control adjustments.

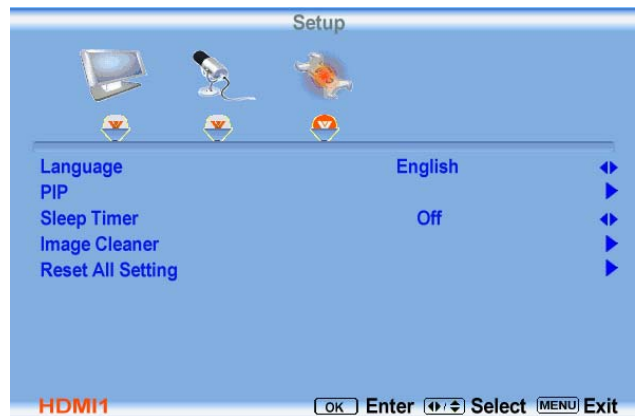

4.10 Video Input Picture Adjustment

The Picture Adjust menu operates in the same way for Video Inputs (Component and AV) as for the DTV / TV input in section 4.2. The menu difference is that there is no icon along the top for DTV / TV adjustments.

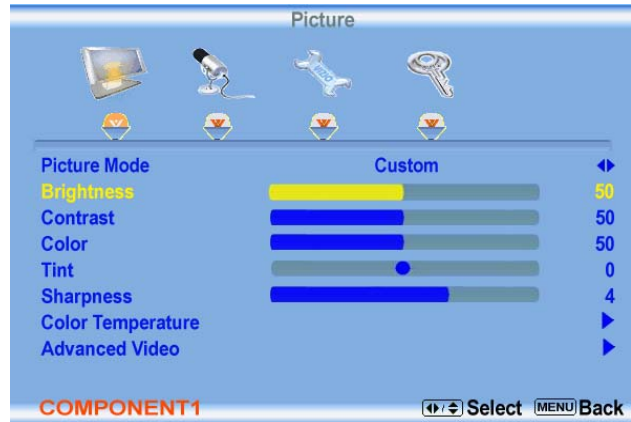

4.11 Video Input Audio Adjustment

The Audio Adjust menu operates in the same way for Video Inputs (Component and AV) as for the DTV / TV input in section 4.3. The menu difference is that there is no icon along the top for DTV / TV adjustments.

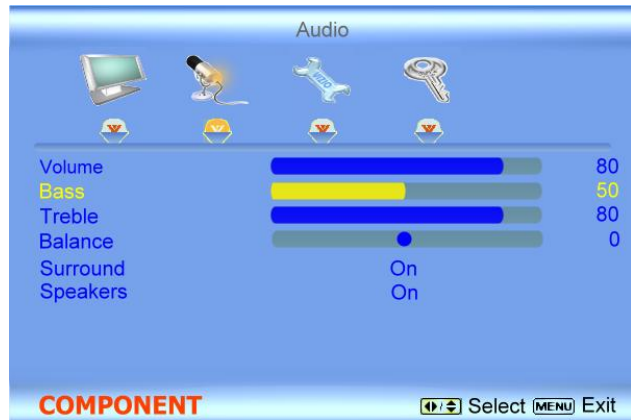

4.12 Video Input Setup

The Setup menu operates in the same way for Video Inputs (Component and AV) as for the DTV/TV input in section 4.5. The menu difference is that there is no icon along the top for TV adjustments.

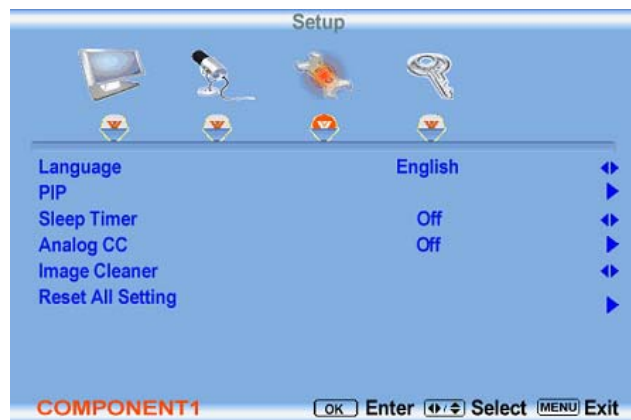

4.13 Video Input Parental Control

The Parental Control menu operates in the same way for Video Inputs (Component and AV) as for the DTV / TV input in section 4.6. The menu difference is that there is no icon along the top for DTV / TV adjustments.



4.14 PC Input Picture Adjustment

The Picture Adjust menu operates in the same way for the PC Input as for the DTV / TV input in section 4.2 for Backlight, Contrast, Brightness and Color Temperature.

4.14.1 Auto Adjust

When the MENU button is pressed, the On Screen Display (OSD) appears on the PICTURE adjustment page. Press the button to highlight the Auto Adjust selection.

Press the button for the Plasma HDTV to adjust to the PC signal timing automatically.

Press either the **MENU** key to return to the previous menu display or the **EXIT** key to return to your program if task has been completed.

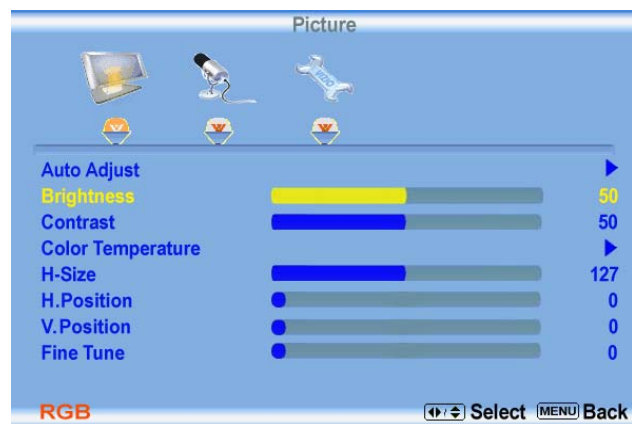

4.14.2 Brightness

Press the button to highlight the Brightness selection.

Press the button to start adjusting the brightness and the menu page will disappear and be replaced by a small Brightness Indicator Bar so you can see the brightness level between the minimum and maximum available levels.

Use the or button to adjust the level.





The Brightness adjusts the black levels in the picture. If the brightness is too low you will not be able to see the detail in darker parts of the picture and if the brightness is too high the picture will look washed out.

Press either the **MENU** key to return to the previous menu display or the **EXIT** key to return to your program if task has been completed.



4.14.3 Contrast

Press the  button to highlight the Contrast selection.

Press the  button to start adjusting the contrast and the menu page will disappear and be replaced by a small Contrast Indicator Bar so you can see the contrast level between the minimum and maximum available levels. Use the  or  button to adjust the level.





The Contrast adjusts the white levels in the picture. If the contrast is too low the picture will look washed out and if the contrast is too high you will not be able to see any detail in the bright parts of a picture.

Press either the **MENU** key to return to the previous menu display or the **EXIT** key to return to your program if task has been completed.

4.14.4 Color Temperature

Press the  button to highlight the option for Color Temperature selection.

The default is COOL; this is the 9300K setting.

Press the  or  button if you want to choose the Normal or Custom option.

Press either the **MENU** key to return to the previous menu display or the **EXIT** key to return to your program if task has been completed.

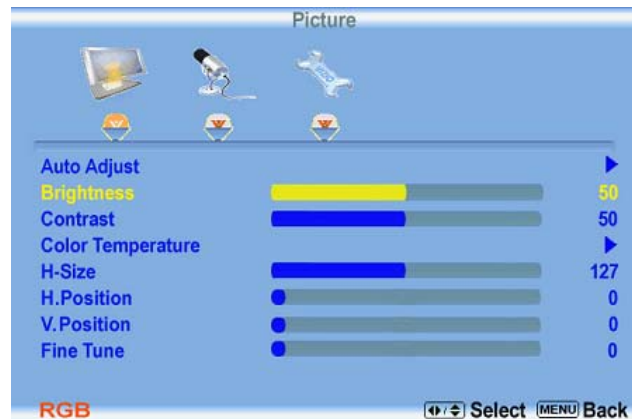

If you choose the Custom option, then a new menu will be displayed showing the primary color items, Red, Green and Blue.

Press the  button to highlight the color you wish to adjust.

Press the  button to start adjusting the color and the menu page will disappear and be replaced by a small Color (Red, Green or Blue) Indicator Bar as before.

Use the  or  button to adjust the color.

Press the OK button when finished. Repeat the procedure to adjust the other colors if desired.



Press either the **MENU** key to return to the previous menu display or the **EXIT** key to return to your program if task has been completed.



4.14.5 H-SIZE

Press the  button to highlight the H-Size selection.

Press the  button to start adjusting the horizontal size of the picture.



Use the  or  button to adjust the horizontal size.

Press either the **MENU** key to return to the previous menu display or the **EXIT** key to return to your program if task has been completed.

4.14.6 H. Position

Press the  button to highlight the Horizontal Shift selection.

Press the  button to start adjusting the horizontal position of the picture.

Use the  or  button to adjust the horizontal position.

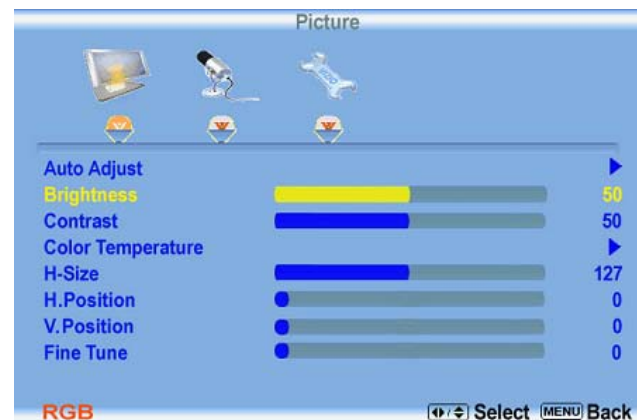

Press either the **MENU** key to return to the previous menu display or the **EXIT** key to return to your program if task has been completed.



4.14.7 V. Position

Press the  button to highlight the Vertical Shift selection.

Press the  button to start adjusting the vertical position of the picture.

Use the  or  button to adjust the vertical position.

Press either the **MENU** key to return to the previous menu display or the **EXIT** key to return to your program if task has been completed.

4.14.8 Fine Tune

Press the  button to highlight the Fine Tune selection.

Press the  button to start tuning the to the PC signal.

Use the  or  button to adjust the tuning.

Press either the **MENU** key to return to the previous menu display or the **EXIT** key to return to your program if task has been completed.



4.15 PC Input Audio Adjustment

The Audio Adjust menu operates in the same way for the PC Input as for the DTV / TV input in section 4.3. The menu difference is that there are no icons along the top for DTV / TV and Parental Control adjustments.

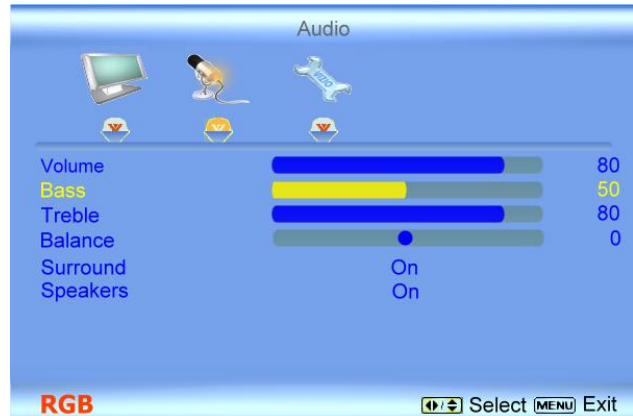

4.16 PC Input Setup

The Setup menu operates in the same way for the PC Input as for the DTV / TV input in section 4.5. The menu difference is that there is no icon along the top for TV adjustments and no Closed Caption.

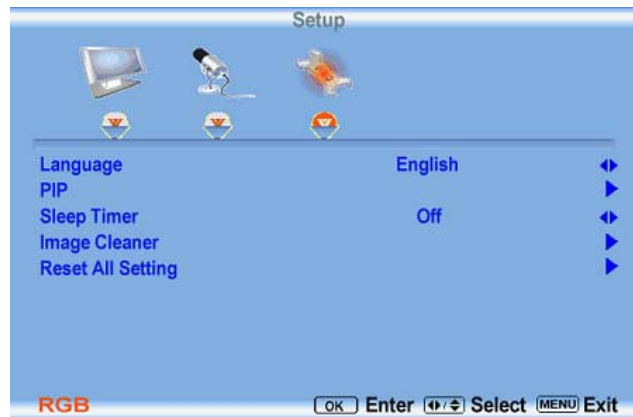

4.17 Understanding Viewing Modes

Normal Mode

The original 4:3 aspect ratio (1.33:1 source) is preserved, so black bars are added to the left and right of the display image. Standard TV broadcasts are displayed with a 4:3 Aspect Ratio. Movies in 4:3 Aspect Ratio may be referred to as pan-and-scan or full frame. These movies were originally filmed in 16:9 (widescreen), and then modified to fit a traditional TV screen (4:3).

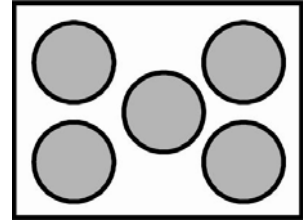

Wide Mode

When watching a standard broadcast or full-frame movie in this mode, the display image is stretched proportionately to fill the TV screen.

When watching a widescreen (1.78:1 source) program or movie, the display image fills the TV screen. If you are watching a widescreen (1.85:1 or 2.35:1 source) program or movie, there will still be black bars at the top and bottom.

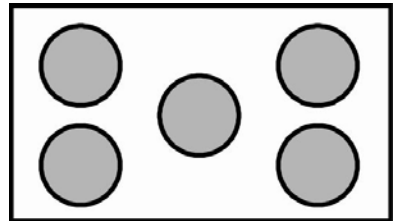

When watching a standard definition 4:3 aspect ratio (1.33:1 source) the picture will fill the screen but will be stretched horizontally; people will look fatter than they are.

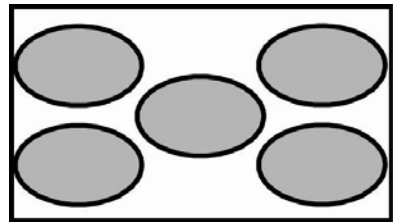

Zoom Mode

When watching a widescreen (1.78:1, 1.85:1, or 2.35:1 source) program or movie, the display image is zoomed proportionally to fill the width of the screen. The top and bottom are cut off to remove most of the source material's black bars. This mode is good for programs or movies with sub-titles.

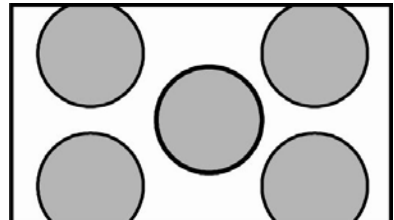

Panoramic Mode

When watching a standard broadcast or full frame movie in this mode, the 4:3 Aspect Ratio (1.33:1 source) display image is stretched horizontally on the left and right sides to fill the TV screen. The center of the image is not stretched.

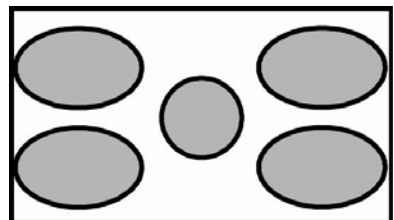

4.17.1 Picture-In-Picture (PIP) Mode

Your TV features PIP mode so you can watch two pictures at the same time. When PIP is turned on, you can display two pictures at one time. One picture is displayed as the full screen (main screen) and the other picture is displayed in a small window (sub screen). The sub-screen can be set to small, medium or large.

See below for detailed information regarding the PIP sources.

MAIN \ SUB	SUB					
	DTV / TV	AV	Component	RGB	HDMI	
DTV / TV			✓	✓	✓	
AV			✓	✓	✓	
Component	✓	✓			✓	
RGB	✓	✓			✓	
HDMI	✓	✓	✓	✓		

“✓” – Indicates which inputs are available for PIP mode.

*When HDMI is used for the Sub-Screen it cannot support 1080i.

4.17.2 Adjusting Basic PIP Settings

The PIP channel is independent of the main TV channel. To change the PIP channel, press the PIP CH + or CH - button on the remote control.

Repeated pressing of the PIP button will turn on, turn off the PIP mode.

Main
TV
AV1
AV2
AV3
COMPONENT1
COMPONENT2
RGB
HDMI1
HDMI2
HDMI3

Repeated pressing of the PIP INPUT button will cycle through the inputs for PIP. This button has no effect when PIP is off.



Press the PIP SIZE button to alternate between Small, Medium and Large PIP sizes.

You can swap the program that is in the main picture with the program in the PIP sub-picture. To swap the main picture program with the PIP sub-picture program, press SWAP on the remote control. If you press SWAP again, it will return the program to the main picture.



Chapter 5 Programming the VIZIO Universal Remote Control

You can program the remote control to work with up to four different pieces of equipment including your VIZIO VP50 HDTV20A. Listed below are the steps for programming your VCR, Cable Box and DVD Player.

5.1.1 Programming for VCR

1. Manually turn on the VCR.
2. Press the VCR button on the remote control.
3. Press and hold the SET button until the LED LIGHT flashes twice.
4. Find the programming code for your VCR in the code list in the back of this book and enter it using the Number Buttons. If the code is accepted, the LED flashes twice after the last digit is entered.
If the LED does not flash twice, repeat Steps 2 through 4 with the next code listed for the component and manufacturer.
5. Point the remote control at the VCR and press the POWER button. The VCR will turn off.

Note:

- a) If your VCR does not respond, try all the codes for your VCR brand. If the codes do not work, or your brand is not listed, see "Searching for Component Codes."
- b) Sometimes a code listed will only include limited functions. Try other codes that may include more functionality.

5.1.2 Programming for Cable Set-Top Box

1. Manually turn on the Cable Box.
2. Press the CBL button on the remote control.
3. Press and hold the SET button until the LED LIGHT flashes twice.
4. Find the programming code for your Cable Box in the code list in the back of this book and enter it using the Number Buttons. If the code is accepted, the LED flashes twice after the last digit is entered.
If the LED does not flash twice, repeat Steps 2 through 4 with the next code listed for the component and manufacturer.
5. Point the remote control at the Cable Box and press the POWER button. The Cable Box will turn off.

Note:

- a) If your Cable Set-Top Box does not respond, try all the codes for your brand. If the codes do not work, or your brand is not listed, see "Searching for Component Codes."
- b) Sometimes a code listed will only include limited functions. Try other codes that may include more functionality.



5.1.3 Programming for DVD Player

1. Manually turn on the DVD Player.
2. Press the DVD button on the remote control.
3. Press and hold the SET button until the LED LIGHT flashes twice.
4. Find the programming code for your DVD player in the code list in the back of this book and enter it using the Number Buttons. If the code is accepted, the LED flashes twice after the last digit is entered.
If the LED does not flash twice, repeat Steps 2 through 4 with the next code listed for the component and manufacturer.
5. Point the remote control at the DVD Player and press the POWER button. The DVD Player will turn off.

Note:

- a) If your DVD player does not respond, try all the codes for your brand. If the codes do not work, or your brand is not listed, see "Searching for Component Codes."
- b) Sometimes a code listed will only include limited functions. Try other codes that may include more functionality.

5.1.4 Searching for Component Codes

If you cannot find the manufacturer in the component list or the program code does not work, you can use the remote control to search for the correct component code.

To search for a component code:

1. Turn on the component.
2. Press the matching component button on the remote control.
3. Press and hold the SET button until the LED flashes twice.
4. Press 9 9 1. The LED flashes twice.
5. Point the remote control at the component and then alternate between pressing the POWER button and the component button on the remote control until the component turns off. If the component still does not respond, clear the component button, then repeat the search procedure.

5.2 Using a Cable or Satellite Remote

Your VIZIO remote uses codes 11758 and 10178 to work your LCD HDTV. To use a cable or satellite remote to work the LCD HDTV, refer to your cable or satellite remote user guide for more information on how to program the remote. If your cable or satellite remote uses a 5-digit code (like most Direct TV units), first try 11758 and then, if that does not work, 10178. If your cable or satellite remote uses a 4-digit code, try 1758 and then 0178 as an alternative. If your cable or satellite remote uses a 3-digit code (EchoStar or Dish Network for example), use code 627.

Note: Some buttons may not function as expected on your cable or satellite remote. Typically power, volume and mute will work.



Chapter 6 Maintenance and Troubleshooting

6.1 Maintenance

Important

1. Make sure that the power cable is removed from the socket before cleaning the TV.
2. Do not use volatile solvent (such as toluene, rosin and alcohol) to clean the TV. Such chemicals may damage the housing, screen glass and remote control, and cause paint to peel.

Cleaning the Housing and Remote Control

1. Use the VIZIO soft cloth (included) for cleaning.
2. If the housing or remote control is seriously contaminated, use a soft cloth moistened with diluted neutral cleaner to clean the display. Wring water out of the cloth before cleaning to prevent water from penetrating into the housing. Wipe the display with a dry cloth after cleaning.

Cleaning the Screen

1. Use the VIZIO soft cotton cloth (included) to gently clean the screen.
2. The screen glass is very fragile. Do not scrape it with any sharp object. Do not press or tap the screen to avoid cracking. When the screen is seriously contaminated, use a soft cloth moistened with diluted neutral cleaner to clean the display. Wring water out of the cloth before cleaning to prevent water from penetrating into the housing. Wipe the display with a dry cloth after cleaning.

6.2 Troubleshooting Guide

If the TV fails or the performance changes dramatically, check the display in accordance with the following instructions. Remember to check the peripherals to pinpoint the source of the failure. If the display still fails to perform as expected, contact the VIZIO for assistance by calling 1-(949) 428-2525 or e-mail us at techsupport@vizio.com.

Problem	Solution
No power.	<p>Make sure the power button is ON (White VIZIO Logo).</p> <p>Make sure AC power cord is securely connected to the AC socket.</p> <p>Plug another electrical device (like a radio) to the power outlet to verify that the outlet is supplying the proper voltage.</p>
No sound.	<p>Check your audio connection</p> <p>Press MUTE on the remote control, so that mute symbol disappears from the screen</p> <p>Check your audio settings, your TV audio may be set to SAP, min or speakers off</p> <p>Press the Volume + (Up) key on your remote control</p> <p>Make sure that headphones are not connected</p>
If the screen is black.	Check your input connections.
Power is ON but no screen	Make sure the video cable supplied with the TV is secured to the correct video



Problem	Solution
image.	output port on the back of the VCR and the TV. Make any cable you have attached to the TV is secured to the correct output your Set-Top Box, DVD, etc. Adjust brightness and contrast. Check Source settings.
Wrong or abnormal colors appear.	If any colors (red, green, or blue) are missing, check the video cable to make sure it is securely connected.
Control buttons do not work.	Press only one button at a time.
Remote Control does not work.	Make sure batteries are inserted correctly Batteries could be weak.
There appears to be image quality issues.	For best image quality, view HD wide screen programs where possible. If HD content is not available view "Standard Definition" from a digital source. Standard, analog TV will always be noticeably inferior to HD because your digital flat panel TV has video that is many times better than old TV's and so you can see interference and deficiencies you did not know you had.
You cannot see a picture.	Make sure that the power cord is plugged into a grounded electrical outlet. Make sure that the power button is turned on. Make sure that the selected input source is connected to a working input source. If your TV is connected to your computer in RGB or HDMI mode, press any key on your keyboard to "wake" your computer.
You see a distorted picture or hear unusual sound.	You may be getting interference from electrical appliances, cars, motorcycles, or fluorescent lights. If you have not mounted it on the wall, try moving your TV to another location to see if this is the cause of the problem.
The picture has abnormal patterns.	Make sure that the input source cable is attached securely and correctly to the back of your TV. Make sure that the video input source is within the range of your TV. Compare the video input source's specifications with your TV specifications.
The display image does not cover the entire screen.	If you are using RGB mode, make sure that H Size and V Position in the On Screen Display (OSD) are set correctly. If you are using TV, AV-C, AV-S or Component with 480i input, use the WIDE button on the remote control to scroll through various screen modes.
You can see a picture but you cannot hear sound.	Make sure that the volume is not turned down. Make sure that the sound is not muted. Make sure that your audio input source cables are connected securely and correctly.
The TV has pixels that are always dark or colored.	Your Plasma HDTV is manufactured using an extremely high level of precision technology, however, sometimes some pixels of your Plasma HDTV may not display. Pixel defects within industry specifications are inherent to this type of product and do not constitute a defective product.
You see "noise" or "trash" on the screen.	When your Plasma HDTV's digital capabilities exceed a digital broadcast signal, the signal is up-converted (increased) to match your TV's display capabilities. Up-converting can cause noise or trash.
You switch to a different input and the volume changes.	The TV remembers the volume level from the last time you adjusted it. If the sound level is higher or lower from another source, then the loudness will change.
You switch to a different input and the screen size changes.	The TV remembers the viewing mode from the last time you used a particular input (AV, Component, HDMI and TV).
Tips for High-Definition Users.	The Plasma HDTV is an ideal platform for viewing High Definition Content. Best Image Quality will be achieved by the HDMI Input, then YPbPr, then RGB. However, due to variances in broadcast practices, it is possible some image distortions can occur.



Problem	Solution
Tips for Letterbox Content Users.	Letterboxed (or "Widescreen") versions of DVD movies are most commonly formatted for standard 4:3 Televisions. The Plasma HDTV has the capability of expanding this content so the entire screen is filled at the expense of image accuracy. To use this function, press the "ZOOM" key on the remote control and cycle among the available options.

6.3 Telephone & Technical Support

Products are often returned due to a technical problem rather than a defective product that may result in unnecessary shipping charges billed to you. Our trained support personnel can often resolve the problem over the phone. For more information on warranty service or repair, after the warranty period, please contact our Support Department at the number below.

Customer support and quality service are integral parts of VIZIO's commitment to service excellence. For technical assistance contact our VIZIO Technical Support Department via email or phone.

E-mail: techsupport@vizio.com

Tel: (949) 428-2525

Hours of operations:

6:00am – 6:00pm PST Monday – Friday

10:00am – 2:00pm PST Saturday – Sunday

Please have your VIZIO model number, serial number and date of purchase available before you call.

VIZIO

39 Tesla, Irvine, CA 92618

Tel: (949) 428-2525 Fax: (949) 585-9514

Web: www.VIZIO.com



6.4 Compliance

Caution: Always use a power cable that is properly grounded. Please use the AC cords listed below for each area.

USA	UL
Canada	CSA
Germany	VDE
UK	BASE/BS
Japan	Electric Appliance Control Act

6.5 FCC Class B Radio Interference Statement

NOTE: This equipment has been tested and found to comply with the limits for a Class B digital device, pursuant to Part 15 of the FCC Rules. These limits are designed to provide reasonable protection against harmful interference in a residential installation. This equipment generates, uses and can radiate radio frequency energy, and if not installed and used in accordance with the instructions, may cause harmful interference to radio communications. However, there is no guarantee that interference will not occur in a particular installation. If this equipment does cause harmful interference to radio or television reception, which can be determined by turning the equipment off and on, the user is encouraged to try to correct the interference by one or more of the following measures:

1. Reorient or relocate the receiving antenna.
2. Increase the separation between the equipment and receiver.
3. Connect the equipment into an outlet on a circuit different from that to which the receiver is connected.
4. Consult the dealer or an experienced radio/TV technician for help.

Notice:

1. The changes or modifications not expressly approved by the party responsible for compliance could void the user's authority to operate the equipment.
2. Shielded interface cables and AC power cord, if any, must be used in order to comply with the emission limits.
3. The manufacturer is not responsible for any radio or TV interference caused by unauthorized modification to this equipment. It is the responsibilities of the user to correct such interference.



Chapter 7 Miscellaneous Information

7.1 Specifications

Specifications	
Panel	50" Diagonal, 16:9 Aspect Ratio
Resolution	1365 x 768 pixels
Pixel (Dot) Pitch	0.810mm (H) x 0.810mm (V)
Display Compatibility	1080i (HDTV)
Signal Compatibility	480i (SDTV), 480P (EDTV), 720P (HDTV), 1080i (HDTV)
Colors	1073 Million
Brightness	1300cd/m ² (typical)
Contrast	15000 : 1
Viewing Angle	Greater than 170° (horizontal and vertical)
Inputs	1x RF (F Connector for internal ATSC/QAM/NTSC Hybrid Tuner x1) 3x HDMI with HDCP plus x1 Stereo Analog Audio 2x Component YPbPr plus Stereo Audio 2x Composite Video + Stereo Audio / 1x S-Video plus Stereo Audio 1x Analog RGB plus Stereo Audio
Outputs	1x SPDIF Optical Digital Audio (from digital TV only), 1x Analog Audio
Features	PIP, Zero Bright Pixel, 3:2 or 2:2 Reverse Pull-down, ATSC, with 8VSB & QAM demodulation, with MPEG-2 decoding, NTSC Video decoding via RF (Antenna, Cable or Satellite) or Video (CVBS, S-Video or Component), Progressive Scan Video via Component YPbPr, VGA or HDMI, HDTV via HDMI or Component YPbPr, Computer 640x480, 800x600, 1024x768 via VGA or 640x480 via HDMI, Color Temperature of 6500K, 5400K and 9300K (default) in VGA, 7000K in Video, Independent Red, Green and Blue adjustment in TV, Video, HDMI and VGA for user fine tuning of color temperature with reset.
Speakers	Built-in, 10W x 2
Panel Life	60,000 hours to half the original brightness
Input	IEC Connector for direct power line connection
Voltage Range	100 ~ 240Vac at 50/60Hz
Power Consumption	500W
Operating	Temperature: 5°C~35°C, Relative Humidity: 20~80%, Altitude: 0~6,500 ft
Non-Operating	Temperature: -20°C~50°C, Relative Humidity: 10~90%, Altitude: 0~10,000 ft
Dimensions	48.8" W x 34.2" H x 12.2" D with stand;48.8" W x 33.5" H x 3.9" D without stand
Net Weight	120lbs with stand; 108lbs without stand
Gross Weight	144lbs
Certifications	CSA/CSA-US, FCC Class B

*Product specifications may change without notice or obligation.



7.2 Glossary - Standard Definitions

Analog TV: Today's TV system using radio frequency waves to transmit and display pictures and sound.

Aspect Ratio (4x3): Traditional TV "aspect ratio", that is, the screen's width as compared to its height. For example, a "32 inch TV screen" would be 25 inches wide and 19 inches tall.

Aspect Ratio (16x9): "Wide screen TV" aspect ratio which is more like a movie screen than a traditional TV. For example, a "32 inch TV screen" would be 28 inches wide and 16 inches tall.

Digital TV (DTV): Television delivered and displayed using radio frequency waves that contain information that is digitally encoded for improved quality and efficiency.

Enhanced Definition TV (EDTV): A better digital television transmission than SDTV with at least 480P, in a 16x9 or 4x3 display and Dolby digital surround sound. 480P is the quality used by most DVD players. EDTV provides 300-400,000 pixels.

HDTV Monitor (sometimes called HDTV Ready): A set that can display HDTV programming if you have a separate HDTV tuner, HD Cable Set-Top Box or HD Satellite Set-Top-Box Receiver.

HDTV Tuner (also decoder, receiver, set-top box): A device capable of receiving and outputting HDTV signals for display. It may be stand-alone or integrated in the set.

High-Definition Television (HDTV): The best quality picture, wide screen (16x9) display with at least 720 progressively scanned lines (720P) or 1080 interlaced lines (1080i) and Dolby digital surround sound. HDTV provides 900,000-2.1 million pixels.

Integrated HDTV: An HDTV that has the digital tuner built into the set. It does not need a separate set-top box to receive over-the-air DTV signals.

Interlace Scan: A way to scan vertical lines onto a TV picture by scanning all the odd lines first, then filling the in the even lines (this happens instantaneously).

Plug-and-Play or Digital Cable Ready: A DTV or other device for digital cable consumers that plugs directly into the cable jack and does not require a separate set-top box. Plug-and-Play TV owners must obtain a CableCARD from their cable company in order to view scrambled programming services.

Progressive Scan: A way to scan vertical lines onto a TV picture by scanning all the lines consecutively (progressively).

Standard Definition TV (SDTV): Basic digital television transmission that may be displayed with fewer than 480 progressively scanned lines (480P) in 16 x 9 or 4 x 3 format. 480 interlaced (480i) is the quality of today's analog TV system.

Source: Buying a Digital Television, CEA, HDTV Guide, 2005

Note: The Federal Communications Commission (FCC), the Consumer Electronics Association (CEA) and the Consumer Electronics Retailers Coalition (CERC) have made a new tip sheet available for digital television (DTV) retailers to reproduce and distribute to consumers on the sales floor. The file may be downloaded online at www.dtv.gov. While you're there, check out the other useful information in the FCC is making available to consumers interested in learning more about the analog to digital transition.



7.3 Index

A

- Accessories, 4
- Adjustments
 - Closed Caption, 11
 - Selecting the Screen Size, 27, 46, 53
 - Selecting the Screen Size, 11
 - Stepping through TV Channels, 27
 - Volume, 8, 27, 49
- Advanced Video Features
 - Adaptive Luma, 33
 - Black Level Extender, 33
 - CTI (Color Transient Improvement), 33
 - DNR (Dynamic Noise Reduction), 33
 - Flesh Tone, 33
 - White Peak Limiter, 33

C

- Cleaning your VIZIO TV, 48
- Coax (RF)
 - Connecting for DTV, 14
 - Connecting your Basic Set Top Box, 18
- Component
 - Connecting your DVD Player, 20
 - Connecting your HDTV Set-Top Box, 17
- Composite (AV)
 - Connecting your Basic Set-Top Box, 18
 - Connecting your DVD Player, 21
- Controls
 - Front Panel, 8
 - Side Panel, 8

D

- DTV
 - Audio Adjustment, 34
 - Parental Control, 38
 - Picture Adjustment, 30
 - Special Features, 36
 - Tuner Setup, 35
- DTV Audio Adjust
 - Balance, 34
 - Bass, 34
 - Simulated Surround Sound, 35
 - Speakers On/Off, 35
 - Treble, 34
 - Volume, 34
- DTV Picture Adjust
 - Advanced Video, 33
 - Backlight, 30, 43
 - Brightness, 31, 43
 - Color, 31
 - Color Temperature, 32, 44
 - Contrast, 31, 44
 - Picture Mode, 30
 - Sharpness, 32

- Tint, 31
- DTV Special Features
 - Closed Caption, 36
 - Closed Caption Style, 37
 - Language, 36
 - Reset, 37
 - Sleep Timer, 36
- DTV Tuner Setup
 - Auto Search, 35
 - Daylight Saving, 36
 - Skip Channel, 35
 - Time Zone, 36
 - Tuner Mode, 35
- DVI
 - Connecting your DVD Player, 19
 - Connecting your HDTV Set-Top Box, 16

G

- Glossary, 53

H

- HDMI
 - Connecting your DVD Player, 19
 - Connecting your HDTV Set-Top Box, 15
- HDMI Input
 - Audio Adjustment, 41
 - Picture Adjustment, 41
 - Setup, 41

I

- Inputs
 - Antenna, 3
 - Connectors, 13
 - Rear Label, 9
- Installation
 - Base removal, 5
 - Preparation, 5
 - Safety Instructions, 2
 - Wall Mounting, 5, 24

O

- OSD
 - Brightness Adjustment, 52
 - Closed Caption Selection, 11
 - Color Adjustment, 13
 - Contrast Adjustment, 52

P

- Parental Control
 - Block Unrated Programming, 40
 - Channel Block, 38
 - Movie Rating, 39



- Password change, 40
- TV Rating, 39
- PC Input
 - Audio Adjustment, 45
 - Picture Adjustment, 43
 - Setup, 45
- PC Picture Adjust
 - Auto Adjust, 43
 - Fine Tune, 45
 - Horizontal Position, 45
 - Horizontal Size, 45
 - Vertical Position, 45
- PC Resolutions, 23
- PIP and POP Inputs, 47

R

- Remote
 - Batteries, 12
 - Range, 12
- Remote Control
 - Setting the Sleep Timer, 48
 - Using your Cable or Satellite Remote to Operate your VIZIO TV, 48
- RGB
 - Connecting your PC, 23

S

- Screen Size explanation, 46
- S-Video
 - Connecting your DVD Player, 21
 - Connecting your VCR, 22
 - Connecting your Video Camera, 22

T

- Technical Specifications, 52
- Troubleshooting Guide, 49
- TV
 - Audio Adjustment, 34
 - Parental Control, 38
 - Picture Adjustment, 30
 - Special Features, 36

- TV Audio Adjust
 - Balance, 34
 - Bass, 34
 - Simulated Surround Sound, 35
 - Speakers On/Off, 35
 - Treble, 34
 - Volume, 34
- TV Picture Adjust
 - Advanced Video, 33
 - Backlight, 30, 43
 - Brightness, 31, 43
 - Color, 31
 - Color Temperature, 32, 44
 - Contrast, 31, 44
 - Picture Mode, 30
 - Sharpness, 32
 - Tint, 31
- TV Special Features
 - Closed Caption, 36
 - Language, 36
 - Reset, 37
 - Sleep Timer, 36
- TV Tuner Setup, 35
 - Auto Search, 35
 - Skip Channel, 35
 - Tuner Mode, 35

V

- Video Input
 - Audio Adjustment, 42
 - Parental Control, 43
 - Picture Adjustment, 42
 - Setup, 42

W

- Watching TV
 - Basic Adjustments, 27
 - Basic connections, 24
 - First Startup, 24
 - Getting your Programs, 27
 - Program Information, 28
 - Status Information, 28



7.4 Component Program Codes

Setup Code for VCR's	
ABS	21972
Admiral	20048, 20209
Aiko	20278
Aiwa	20037, 20479
Alienware	21972
America Action	20278
American High	20035
Amoisonic	20479
Anam	20162, 20037, 20240, 20278
Anam National	20162
Asha	20240
Audiovox	20037, 20278
Beaumarck	20240
Bell & Howell	20104
Broksonic	20184, 20121, 20209, 20002, 20479
Calix	20037
Canon	20035
Carver	20081
CCE	20072, 20278
Changhong	20048, 20081
Citizen	20037, 20278
Colt	20072
Craig	20037, 20047, 20240, 20072
Curtis Mathes	20060, 20035, 20162
Cybernex	20240
CyberPower	21972
Daewoo	20045, 20104, 20278
Dell	21972
Denon	20042
DirecTV	20739
Durabrand	20039, 20038
Electrohome	20037
Electroponic	20037
Emerex	20032

Setup Code for VCR's	
Emerson	20035, 20037, 20184, 20240, 20045, 20121, 20043, 20209, 20002, 20278, 20479
Fisher	20047, 20104
Fuji	20035, 20033
Fujitsu	20045
Gateway	21972
GE	20060, 20035, 20240
General	20045
Go Video	20432
GoldStar	20037, 20209, 20038, 20225
Haojie	20240
Harman/Kardon	20081, 20038
Harwood	20072
Hewlett Packard	21972
HI-Q	20047
Hitachi	20037, 20042, 20055
Howard Computers	21972
HP	21972
Hughes Network Systems	20042, 20739
iBUYPOWER	21972
JVC	20045, 20067
KEC	20037, 20278
Kenwood	20067, 20038
KLH	20072
Kodak	20035, 20037
Kolin	20043
LG	20037, 20045, 20042, 20209, 20038
Logik	20072
LXI	20037
Magnavox	20035, 20039, 20081
Magnin	20240
Marantz	20035, 20081

Setup Code for VCR's	
Marta	20037
Matsushita	20035, 20162
Media Center PC	21972
MEI	20035
Memorex	20035, 20162, 20037, 20048, 20039, 20047, 20240, 20104, 20209, 20479
MGA	20240, 20043
MGN Technology	20240
Microsoft	21972
Mind	21972
Minolta	20042
Mitsubishi	20067, 20043
Motorola	20035, 20048
MTC	20240
Multitech	20072
NEC	20035, 20037, 20048, 20104, 20067, 20038
Newave	20037
Nikko	20037
Noblex	20240
Northgate	21972
Olympus	20035
Optimus	21062, 20162, 20037, 20048, 20104, 20432
Orion	20184, 20209, 20002, 20479
Panasonic	21062, 20035, 20162, 20616, 20225
Penney	20035, 20037, 20240, 20042, 20038
Pentax	20042
Philco	20035, 20479
Philips	20035, 20081, 20739, 20618
Pilot	20037
Pioneer	20042, 20067
Polk Audio	20081



Setup Code for VCR's	
Profitronic	20240
Proscan	20060
Protec	20072
Pulsar	20039
Qisheng	20060
Quasar	20035, 20162
Radix	20037
Randex	20037
RCA	20060, 20035, 20240, 20042, 20880
Realistic	20035, 20037, 20048, 20047, 20104
ReplayTV	20616
Runco	20039
Sampo	20037, 20048
Samsung	20240, 20045, 20432
Sanky	20048, 20039
Sansui	20067, 20209, 20479
Sanyo	20047, 20240, 20104
Scott	20184, 20045, 20121, 20043
Sears	20035, 20037, 20047, 20042, 20104
Sharp	20048, 20209
Shintom	20072
Shogun	20240
Singer	20072
Sonic Blue	20616
Sony	20035, 20032, 20033, 20636, 21972
STS	20042
Sylvania	20035, 20081, 20043
Systemax	21972
Tagar Systems	21972
Tashiko	20037
Tatung	20045, 20067
Technics	20035, 20162

Setup Code for VCR's	
Teco	20035, 20037, 20048, 20038
Teknika	20035, 20037
Tivo	20636, 20618, 21503, 20739
TMK	20240
Toshiba	20045, 20042, 20067, 20043, 21503, 21008, 21972
Totevision	20037, 20240
Touch	21972
Unitech	20240
Vector	20045
Vector Research	20038
Victor	20067
Video Concepts	20045
Videomagic	20037
Videosonic	20240
Viewsonic	21972
Wards	20060, 20035, 20048, 20047, 20081, 20240, 20042, 20072
White Westinghouse	20209, 20072
XR-1000	20035, 20072
Yamaha	20038
Zenith	20039, 20033, 20209, 20479
ZT Group	21972

Setup Code for Cable Converters	
ABC	00003, 00008, 00014
Americast	00899
Bell & Howell	00014
Bell South	00899
Clearmaster	00883
ClearMax	00883
Coolmax	00883
Daeryung	01877, 00877, 00477, 00008
Digi	00637

Setup Code for Cable Converters	
Director	00476
Dumont	00637
Gehua	00476
General Instrument	00476, 00810, 00276, 00003, 00014
GoldStar	00144
Hamlin	00009, 00273
Hitachi	00014
Jerrold	00476, 00810, 00276, 00003, 00012, 00014
KNC	00008
LG	00144
Memorex	00000
Motorola	00476, 00810, 00276, 01254, 01376
MultiVision	00012
Pace	01877, 00237
Panasonic	00000, 00008, 00107
Panther	00637
Paragon	00000
Philips	00317, 01305
Pioneer	01877, 00877, 00144, 00533
Pulsar	00000
Quasar	00000
RadioShack	00883
Regal	00279, 00273
Runco	00000
Samsung	00000, 00144
Scientific Atlanta	01877, 00877, 00477, 00008
Sony	01006
Starcom	00003, 00014
Supercable	00276
Supermax	00883
Tocom	00012
Torx	00003
Toshiba	00000
Trans PX	00276



Setup Code for Cable Converters	
Tristar	00883
TS	00003
V2	00883
Viewmaster	00883
Vision	00883
Vortex View	00883
Zenith	00000, 00525, 00899

Setup Code for Satellite Receivers	
AlphaStar	00772
Chaparral	00216
Crossdigital	01109
DirecTV	00392, 00566, 00639, 01142, 00247, 00749, 01749, 00724, 00819, 01856, 01076, 01109, 00099, 01392, 01640, 01442, 01414, 01108
Dish Network System	01005, 00775, 01505
Dishpro	01005, 00775, 01505
Echostar	01005, 00775, 01505
Expressvu	00775
GE	00566
General Instrument	00869
GOI	00775
Goodmans	01246
Hisense	01535
Hitachi	00819, 00222, 01250
HTS	00775
Hughes Network Systems	01142, 00749, 01749, 01442
I-Lo	01535
JVC	00775
LG	01414, 01226
Magnavox	00724, 00722

Setup Code for Satellite Receivers	
Memorex	00724
Mitsubishi	00749
Motorola	00869
NEC	01270
Next Level	00869
Panasonic	00247, 00701
Paysat	00724
Philips	01142, 00749, 01749, 00724, 01076, 00722, 00099, 01442
Proscan	00392, 00566
Proton	01535
RadioShack	00869
RCA	00392, 00566, 00855, 00143, 01392
Samsung	01276, 01109, 01108
Sanyo	01219
SKY	00856
Sony	00639, 01640
Star Choice	00869
Tivo	01142, 01442
Toshiba	00749, 01749, 00790, 01285
UltimateTV	01640, 01392
Uniden	00724, 00722
US Digital	01535
USDTV	01535
Voom	00869
Zenith	00856, 01856

Setup Code for DVD Players	
Aiwa	20641, 21912
Akai	20770
Allegro	20869
Apex Digital	20672, 20717, 20797, 21061, 20796, 21056, 21937, 20794, 21020, 21915
Blaupunkt	20717

Setup Code for DVD Players	
Blue Parade	20571
Broksonic	20695
Changhong	20627, 21061
CineVision	20869
Coby	21086
Curtis Mathes	21087
CyberHome	21024, 21023, 21129, 20816, 21117
Daewoo	20833, 21172, 20869
Denon	20490
DVD2000	20521
Emerson	20591, 20675
Enterprise	20591
Fisher	21919
Funai	20675
Gateway	21158, 21073
GE	20522, 20717
Go Video	20744, 20833, 21099, 20783, 21075, 20869, 21730
Greenhill	20717
Harman/Kardon	20582, 20702
Hitachi	20573, 20664, 21919
Hiteker	20672
Initial	20717
Integra	20627, 21924
JBL	20702
JVC	20558, 20623, 20867
Kenwood	20490, 20534
KLH	20717, 21020, 21149
Koss	20651, 21980
Lasonic	20798
LG	20591, 20869, 20801
Liquid Video	21980
Lite-On	21158, 21058
Loewe	20511
Magnavox	20503, 20539,



Setup Code for DVD Players	
	21976, 21914, 20675
Marantz	20539
Memorex	20695
Microsoft	20522
Mintek	20717
Mitsubishi	21521, 20521
Nesa	20717
Norcent	21003
Onkyo	20503, 20627, 21924, 20792
Oritron	20651, 21980
Panasonic	20490, 21762, 21990
Philips	20503, 20539, 20646, 21914
Pioneer	20525, 20571
Polaroid	21086, 21061
Polk Audio	20539
Portland	20770
Proscan	20522
Qwestar	20651
RCA	20522, 20571, 20717, 20822
Rio	20869
Rotel	20623
Sampo	20752, 20698
Samsung	20490, 20573, 21932, 21075, 20820
Sansui	20695
Sanyo	20695
Sharp	20630, 20752
Sharper Image	21117
Sherwood	20770
Shinco	20717
Shinsonic	20533
Sonic Blue	20869, 21099
Sony	20533, 20864, 21033, 21904, 21903
SVA	20717
Sylvania	20675
Symphonic	20675

Setup Code for DVD Players	
Teac	20717, 21984, 20809
Technics	20490
Theta Digital	20571
Toshiba	20503, 20695
V, Inc.	20123, 20124
Urban Concepts	20503
Xbox	20522
Yamaha	20490, 20539, 20545
Zenith	20503, 20591, 20869

Setup Code for CD Players	
Aiwa	30157
Burmester	30420
California Audio Labs	30029
Carver	30157, 30179
Denon	30873
DKK	30000
DMX Electronics	30157
Dynamic Bass	30179
Fisher	30179
Garrard	30420
Genexxa	30032
Harman/Kardon	30157, 30173
Hitachi	30032
Integra	30101
JVC	30072
Kenwood	30826, 30626, 30028, 30037, 30036, 30190
Krell	30157
Linn	30157
Magnavox	30157
Marantz	30626, 30029, 30157
MCS	30029
Miro	30000
Mission	30157
MTC	30420

Setup Code for CD Players	
NSM	30157
Onkyo	30868, 30101
Optimus	31063, 30000, 30032, 30037, 30420, 30179, 31075, 30145
Panasonic	30029
Parasound	30420
Philips	30626, 30157
Pioneer	31063, 31062, 30032
Polk Audio	30157
Proton	30157
QED	30157
Quad	30157
Quasar	30029
RadioShack	31075
RCA	31062, 30032, 30420, 30179, 30053
Realistic	30420, 30179
Rotel	30157, 30420
SAE	30157
Sansui	30157
Sanyo	30179
SAST	30157
Sharp	30861, 30037
Silsonic	30888, 30036
Sonic Frontiers	30157
Sony	30490, 30000, 30100
Soundesign	30145
TAG McLaren	30157
Tascam	30420
Teac	30420
Technics	30029
Victor	30072
Wards	30157, 30053
Yamaha	30888, 30036
Zonda	30157



Setup Code for Audio Amplifiers	
Bose	30674
GE	30078
JVC	30331
Marantz	30321
Nakamichi	30321
NEC	30264
Optimus	30395
Realistic	30395
Sansui	30321
Shure	30264
Sony	30689
Soundesign	30078
Victor	30331
Wards	30078
Yamaha	30354, 30133

Setup Code for Audio Amp/Tuners	
ADC	30531
Aiwa	31405, 31243, 30121
Anam	31609, 31074
Audiotronic	31189
Bose	31229
Capetronic	30531
Carver	31189
Coby	31263
Denon	31360, 31142, 30904
Fonmix	31360
Glory Horse	31263
Harman/Kardon	30110
Hitachi	31273
Inkel	30027
Integra	30135
JBL	30110
JVC	30074, 31263
Kenwood	31313, 31570, 30027
KLH	31428

Setup Code for Audio Amp/Tuners	
Magnavox	31189, 31269, 30531
Marantz	31189, 31269, 30039
MCS	30039
Onkyo	30842, 30135
Optimus	31023, 30670, 30531, 31074
Panasonic	31518, 30039
Philips	31189, 31269
Pioneer	31023, 30150, 30014, 30630, 30531
Proscan	31254
Qisheng	31609
Quasar	30039
RadioShack	31263
RCA	31023, 31609, 31254, 30531, 31074
Sharper Image	31263
Silsonic	30176
Sony	31058, 31441, 31258, 31759
Soundesign	30670
Stereophonics	31023
Sunfire	31313
Teac	31074, 31267
Technics	31308, 31518, 30039
Thorens	31189
Victor	30074
Wards	30014
Yamaha	30176, 31276, 31176

Setup Code for TV's	
Addison	10092
Admiral	10093, 10463
Advent	10761, 10842
Aiko	10092
Aiwa	11914
Akai	10812, 10702,

Setup Code for TV's	
	10030, 10672, 11903
Albatron	10700, 10843
America Action	10180
Anam	10250, 10180, 10700
Anam National	10250, 10650
Anhua	10051
AOC	10451, 10093, 10180, 10060, 10030, 10178, 10092
Apex Digital	10748, 10765, 10879, 10767, 11943
Audiovox	10451, 10180, 10875, 10092, 10623
Baile	10661
Beijing	10812, 10661
Bell & Howell	10154
BenQ	11032
Bradford	10180
Broksonic	10236, 10463, 11911, 11938, 11905, 11935, 11929
Cailing	10748
Candle	10030
Carnivale	10030
Carver	10054
Celebrity	10000
Celera	10765
Changcheng	10051, 10661
Changhong	10156, 10765, 11156, 10767
Ching Tai	10092
Chun Yun	10000, 10180, 10700, 10092, 10843
Chung Hsin	10180, 10053
Cinema	10672
Citizen	10060, 10030, 11928, 10092
Clarion	10180
Commercial Solutions	11447, 10047



Setup Code for TV's	
Conrowa	10156, 10145, 11156
Contec	10180
Craig	10180
Crosley	10054
Crown	10180
Curtis Mathes	10047, 10054, 10154, 10451, 10093, 10060, 10702, 10030, 10145, 10166
CXC	10180
Daewoo	10154, 10451, 10180, 10030, 10178, 10672, 11928, 10092, 10661, 11909, 10623, 10700
Dayu	10661
Dell	11080
Denon	10145
Dumont	10017
Durabrand	10463, 10180, 10178, 10171, 11034
Electroband	10000
Emerson	10154, 10236, 10463, 10180, 10178, 10171, 11944, 11909, 11929, 11905, 11928, 10623, 11911
Envision	10030
Ether	10030
Firststar	10236
Fisher	10154
Fortress	10093
Fujitsu	10809, 10853
Funai	10180, 10171, 11904
Furi	10145
Futuretech	10180
Gateway	11756, 11755
GE	11447, 10047, 11454, 10051, 10451, 10180, 10030, 10178, 11917, 10092, 11907, 11922

Setup Code for TV's	
Gibralter	10017, 10030
GoldStar	10154, 10030, 10178, 11926
Grunpy	10180
Haier	11034
Hallmark	10178
Hankook	10180, 10030, 10178
Harley Davidson	11904
Harman/Kardon	10054
Harvard	10180
Havermy	10093
Helios	10865
Hello Kitty	10451
Hisense	10156, 10748, 10145, 11156
Hitachi	10156, 10030, 10178, 11145, 10145, 10092, 11904, 11156
Hongmei	10093
Huafa	10145
Huari	10145
Huodateji	10051
Imperial Crown	10661
Infinity	10054
Inteq	10017
JBL	10054
JCB	10000
Jean	10156, 10051, 10236, 10092
Jensen	10761
Jiahua	10051
Jinfeng	10051
Jinxing	10054, 10156, 10145
JVC	10053, 11923, 11253
Kangli	10661
KEC	10180
Kenwood	10030
KLH	10765, 10767
Kolin	10180, 10150, 10053

Setup Code for TV's	
KTV	10180, 10030
Kunlun	10051, 10661
LG	10060, 10030, 10178, 10856, 10700, 10025
Lloyd's	11904
LXI	10047, 10054, 10154, 10156, 10178
Magnasonic	11928, 11913
Magnavox	11454, 10054, 10030, 10706, 11931, 11254, 11913, 11904, 11944
Magnin	11907
Marantz	10054, 10030, 10704
Matsushita	10250, 10650
Maxent	11755
Megapower	10700
Megatron	10178, 10145
Memorex	10154, 10463, 10150, 10178, 11911, 11926, 11924, 11920, 11927
MGA	10150, 10030, 10178, 11907
Midland	10047, 10017, 10051
Mitsubishi	10154, 10250, 10093, 10236, 10180, 11250, 10150, 10030, 10178, 11917, 10836
Monivision	10843, 10700
Motorola	10093
MTC	10060, 10030
Mudan	10051
Multitech	10180
NAD	10156, 10178, 10866
National	10051
NEC	10154, 10156, 10051, 10053, 10030, 10178, 11704
Newave	10093, 10178,



Setup Code for TV's	
	10092
Nikko	10030, 10178, 10092
Norcent	10748, 10824
NTC	10092
Onwa	10180
Optimus	10154, 10250, 10166, 10650, 11927, 11924, 11913
Optonica	10093
Orion	10236, 10463, 11929, 11911, 11905
Panasonic	10054, 10250, 10051, 10650, 11941, 11927, 11924
Panda	10051, 10706
Penney	10047, 10156, 10051, 10060, 10030, 10178, 11926, 11907
Philco	10054, 10180, 10030, 10178
Philips	11454, 10054, 10000, 10051, 10030, 10178, 10092, 10690
Pilot	10030
Pioneer	10166, 10866, 10679
Portland	10092
Prima	10761
Princeton	10700
Prism	10051
Proscan	11447, 10047, 11922
Proton	10030, 10178
Pulsar	10017
Qingdao	
Quasar	10250, 10051, 11924, 10650
RadioShack	10047, 10154, 10180, 10030, 10178, 11920, 11904
RCA	11447, 10047, 11454, 10000, 10030, 10178,

Setup Code for TV's	
	11547, 11922, 11917, 10092, 11907, 11948, 10090, 10679
Realistic	10154, 10180, 10030, 10178
Rowa	10748
Runco	10017, 10030
Sampo	10154, 10093, 10030, 10178, 10171, 10700, 10650, 11755, 10092
Samsung	10154, 10156, 10060, 10812, 10702, 10030, 10178, 11060, 10814, 10092, 11903, 10090, 10766
Sansui	10463, 11904, 11935, 11929, 11911
Sanyo	10154, 10156, 10180, 10145, 11907
Sanyuan	10093
Scotch	10178
Scott	10236, 10180, 10178
Sears	10047, 10054, 10154, 10156, 10178, 10171, 11926, 11904
Shaofeng	10145
Sharp	10093, 10030, 10650, 11917
Shen Ying	10092
Shencai	10145
Sheng Chia	10093, 10236
Skygiant	10180
Skyworth	10748
Sony	11100, 10000, 10650, 11925, 11904
Soundesign	10180, 10178
Sowa	10156, 10051, 10060, 10178, 10092
Squareview	10171
SSS	10180

Setup Code for TV's	
Starlite	10180
Studio Experience	10843
Supreme	10000
SVA	10748, 10865
Sylvania	10054, 10030, 10171, 11944, 11931
Symphonic	10180, 10171, 11913, 11904
Synco	10000, 10451, 10093, 10060, 10178, 10092
Tacico	10178, 10092
Tandy	10093
Tashiko	10092, 10650
Tatung	10054, 10154, 10156, 10051, 10060, 11156, 11756, 11254
Technics	10250, 10051
Techwood	10051
Teco	10051, 10093, 10178, 10092
Teknika	10054, 10180, 10150, 10060, 10092
Telefunken	10702
Tera	10030
Thomas	11904
Tiane	10093
TMK	10178
TNCi	10017
Tobo	10748
Toshiba	10154, 10156, 10060, 10145, 11945, 11704, 11936, 11156, 11935, 10650, 11918
Tuntex	10030, 10092
TVS	10463
VIZIO	11758, 11756, 10885, 10864
Vector Research	10030
Victor	10250, 10053, 10650
Vidikron	10054



Setup Code for TV's	
Vidtech	10178
Viewsonic	11755, 10885, 10864
Wards	10054, 10030, 10178, 10866, 11156

Setup Code for TV's	
Warumaia	10661
Waycon	10156
White Westinghouse	10463, 11909, 10623
Yamaha	10030

Setup Code for TV's	
Yapshe	10250
Zenith	10017, 10463, 10178, 11904, 11929, 11911, 11909, 10092

