



LCD TV OWNER'S MANUAL

32LG30DC
37LG30DC
42LG30DC

47LG50DC
52LG50DC

Please read this manual carefully before operating your set.
Retain it for future reference.
Record model number and serial number of the set.
See the label attached on the back cover and quote this information to your dealer when you require service.

ENERGY STAR is a set of power-saving guidelines issued by the U.S. Environmental Protection Agency (EPA).



As an ENERGY STAR Partner LG Electronics USA, Inc. has determined that this product meets the ENERGY STAR guidelines for energy efficiency.

P/NO : SAC30708017 (0806-REV01)

WARNING / CAUTION



WARNING / CAUTION
RISK OF ELECTRIC SHOCK
DO NOT OPEN



**TO REDUCE THE RISK OF ELECTRIC SHOCK
DO NOT REMOVE COVER (OR BACK). NO
USER SERVICEABLE PARTS INSIDE. REFER TO
QUALIFIED SERVICE PERSONNEL.**



The lightning flash with arrowhead symbol, within an equilateral triangle, is intended to alert the user to the presence of uninsulated “dangerous voltage” within the product’s enclosure that may be of sufficient magnitude to constitute a risk of electric shock to persons.



The exclamation point within an equilateral triangle is intended to alert the user to the presence of important operating and maintenance (servicing) instructions in the literature accompanying the appliance.

WARNING/CAUTION

TO REDUCE THE RISK OF FIRE AND ELECTRIC SHOCK, DO NOT EXPOSE THIS PRODUCT TO RAIN OR MOISTURE.

NOTE TO CABLE/TV INSTALLER

This reminder is provided to call the CATV system installer’s attention to Article 820-40 of the National Electric Code (U.S.A.). The code provides guidelines for proper grounding and, in particular, specifies that the cable ground shall be connected to the grounding system of the building, as close to the point of the cable entry as practical.

WARNING / CAUTION

To prevent fire or shock hazards, do not expose this product to rain or moisture.

FCC NOTICE

Class B digital device

This equipment has been tested and found to comply with the limits for a Class B digital device, pursuant to Part 15 of the FCC Rules. These limits are designed to provide reasonable protection against harmful interference in a residential installation. This equipment generates, uses and can radiate radio frequency energy and, if not installed and used in accordance with the instructions, may cause harmful interference to radio communications. However, there is no guarantee that interference will not occur in a particular installation. If this equipment does cause harmful interference to radio or television reception, which can be determined by turning the equipment off and on, the user is encouraged to try to correct the interference by one or more of the following measures:

- Reorient or relocate the receiving antenna.
- Increase the separation between the equipment and receiver.
- Connect the equipment to an outlet on a circuit different from that to which the receiver is connected.
- Consult the dealer or an experienced radio/TV technician for help.

Any changes or modifications not expressly approved by the party responsible for compliance could void the user’s authority to operate the equipment.

CAUTION

Do not attempt to modify this product in any way without written authorization from LG Electronics. Unauthorized modification could void the user’s authority to operate this product

SAFETY INSTRUCTIONS

IMPORTANT SAFETY INSTRUCTIONS

Read these instructions.
Keep these instructions.
Heed all warnings.
Follow all instructions.



1 Do not use this apparatus near water.

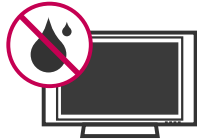

2 Clean only with dry cloth.



3 Do not block any ventilation openings. Install in accordance with the manufacturer's instructions.



4 Do not install near any heat sources such as radiators, heat registers, stoves, or other apparatus (including amplifiers) that produce heat.



5 Do not defeat the safety purpose of the polarized or grounding-type plug. A polarized plug has two blades with one wider than the other. A grounding type plug has two blades and a third grounding prong. The wide blade or the third prong are provided for your safety. If the provided plug does not fit into your outlet, consult an electrician for replacement of the obsolete outlet.



6 Protect the power cord from being walked on or pinched particularly at plugs, convenience receptacles, and the point where they exit from the apparatus.



7 Only use attachments/accessories specified by the manufacturer.



8 Use only with the cart, stand, tripod, bracket, or table specified by the manufacturer, or sold with the apparatus. When a cart is used, use caution when moving the cart/apparatus combination to avoid injury from tip-over.



9 Unplug this apparatus during lightning storms or when unused for long periods of time.

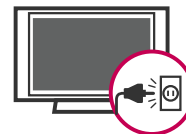

10 Refer all servicing to qualified service personnel. Servicing is required when the apparatus has been damaged in any way, such as power-supply cord or plug is damaged, liquid has been spilled or objects have fallen into the apparatus, the apparatus has been exposed to rain or moisture, does not operate normally, or has been dropped.

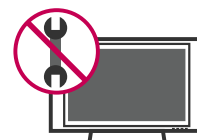

SAFETY INSTRUCTIONS

- 11** Never touch this apparatus or antenna during a thunder or lightning storm.

- 12** When mounting a TV on the wall, make sure not to install the TV by the hanging power and signal cables on the back of the TV.

- 13** Do not allow an impact shock or any objects to fall into the product, and do not drop onto the screen with something.

14 **CAUTION** concerning the Power Cord:

It is recommend that appliances be placed upon a dedicated circuit; that is, a single outlet circuit which powers only that appliance and has no additional outlets or branch circuits. Check the specification page of this owner's manual to be certain.

Do not connect too many appliances to the same AC power outlet as this could result in fire or electric shock.

Do not overload wall outlets. Overloaded wall outlets, loose or damaged wall outlets, extension cords, frayed power cords, or damaged or cracked wire insulation are dangerous. Any of these conditions could result in electric shock or fire. Periodically examine the cord of your appliance, and if its appearance indicates damage or deterioration, unplug it, discontinue use of the appliance, and have the cord replaced with an exact replacement part by an authorized servicer. Protect the power cord from physical or mechanical abuse, such as being twisted, kinked, pinched, closed in a door, or walked upon. Pay particular attention to plugs, wall outlets, and the point where the cord exits the appliance.

Do not make the TV with the power cord plugged in. Do not use a damaged or loose power cord. Be sure do grasp the plug when unplugging the power cord. Do not pull on the power cord to unplug the TV.



- 15** **WARNING** - To reduce the risk of fire or electrical shock, do not expose this product to rain, moisture or other liquids. Do not touch the TV with wet hands. Do not install this product near flammable objects such as gasoline or candles or expose the TV to direct air conditioning.



- 16** Do not expose to dripping or splashing and do not place objects filled with liquids, such as vases, cups, etc. on or over the apparatus (e.g. on shelves above the unit).



17 **GROUNDING**

Ensure that you connect the earth ground wire to prevent possible electric shock. (i.e. a TV with a three-prong grounded AC plug must be connected to a three-prong grounded AC outlet) If grounding methods are not possible, have a qualified electrician install a separate circuit breaker.

Do not try to ground the unit by connecting it to telephone wires, lightning rods, or gas pipes.

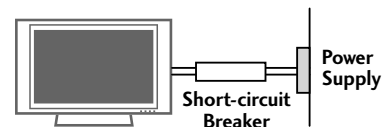

- 18** **DISCONNECTING DEVICE FROM MAINS**
Mains plug is the disconnecting device. The plug must remain readily operable.

- 19** Keep the product away from direct sunlight.

20 ANTENNAS

Outdoor antenna grounding

If an outdoor antenna is installed, follow the precautions below. An outdoor antenna system should not be located in the vicinity of overhead power lines or other electric light or power circuits, or where it can come in contact with such power lines or circuits as death or serious injury can occur.

Be sure the antenna system is grounded so as to provide some protection against voltage surges and built-up static charges.

Section 810 of the National Electrical Code (NEC) in the U.S.A. provides information with respect to proper grounding of the mast and supporting structure, grounding of the lead-in wire to an antenna discharge unit, size of grounding conductors, location of antenna discharge unit, connection to grounding electrodes and requirements for the grounding electrode.

Antenna grounding according to the National Electrical Code, ANSI/NFPA 70

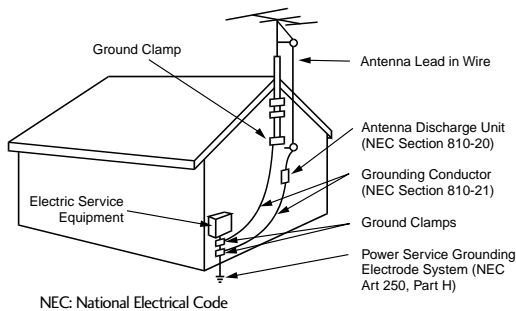

21 Cleaning

When cleaning, unplug the power cord and scrub gently with a soft cloth to prevent scratching. Do not spray water or other liquids directly on the TV as electric shock may occur. Do not clean with chemicals such as alcohol, thinners or benzene.

22 Moving

Make sure the product is turned off, unplugged and all cables have been removed. It may take 2 or more people to carry larger TVs. Do not press against or put stress on the front panel of the TV.

23 Ventilation

Install your TV where there is proper ventilation. Do not install in a confined space such as a bookcase. Do not cover the product with cloth or other materials (e.g.) plastic while plugged in. Do not install in excessively dusty places.

24 If you smell smoke or other odors coming from the TV or hear strange sounds, unplug the power cord contact an authorized service center.

CONTENTS

WARNING / CAUTION	2
SAFETY INSTRUCTIONS	3
FEATURE OF THIS TV	8

PREPARATION

Accessories	9
Front Panel Information	10
Back Panel Information	11
Stand Instruction	13
VESA Wall Mounting	14
Cable Management	15
Desktop Pedestal Installation	15
Swivel Stand	15
Attaching the TV to a Desk	16
Securing the TV to the wall to prevent falling when the TV is used on a stand	17
Antenna or Cable Connection	18

EXTERNAL EQUIPMENT SETUP

HD Receiver Setup	19
DVD Setup	22
VCR Setup	24
PC Setup	26
USB Connection	32
Other A/V Source Setup	32
Audio Out Connection	33

WATCHING TV / CHANNEL CONTROL

Remote Control Functions	34
Turning On the TV	36
Channel Selection	36
Volume Adjustment	36
Quick Menu	37
Initial Setting	38
On-Screen Menus Selection	40

Channel Setup	
- Auto Scan (Auto Tuning)	42
- Add / Delete Channel (Manual Tuning)	43
- Channel Editing	44
Input List	45
Input Label	46
AV Mode	47
SIMPLINK	48

USB

Entry Modes	50
Photo List	51
Music List	55

PICTURE CONTROL

Picture Size (Aspect Ratio) Control	58
Preset Picture Settings	
- Picture Mode - Preset	60
- Color Tone - Preset	61
Manual Picture Adjustment	
- Picture Mode - User Mode	62
- Picture Mode - Expert Control	63
Picture Improvement Technology	64
Advanced Control - Black (Darkness) Level	65
Advanced Control - Eye Care	66
Advanced Control - Real Cinema	67
Picture Reset	68
Power Indicator	69

SOUND & LANGUAGE CONTROL

Auto Volume Leveler (Auto Volume)	70
Preset Sound Settings (Sound Mode)	71
Sound Setting Adjustment - User Mode	72
Clear Voice	73
Balance	74
TV Speakers On/Off Setup	75
Audio Reset	76
Stereo/SAP Broadcast Setup	77
Audio Language	78
On-Screen Menus Language Selection	79
Caption Mode	
- Analog Broadcasting System Captions	80
- Digital Broadcasting System Captions	81
- Caption Option	82

TIME SETTING

Clock Setting	
- Auto Clock Setup	83
- Manual Clock Setup	84
Auto On/Off Time Setting	85
Sleep Timer Setting	86
Auto Shut-off Setting	87

PARENTAL CONTROL / RATINGS

Set Password & Lock System	88
Channel Blocking	91
Movie & TV Rating	92
Downloadable Rating	97
External Input Blocking	98
Key lock	99

APPENDIX

Troubleshooting	100
Maintenance	102
Product Specifications	103
Programming the Remote Control	104
IR Codes	107
External Control Through RS-232C	109
Open Source License	116

FEATURE OF THIS TV



 is a trademark of SRS Labs, Inc.
TruSurround XT technology is incorporated under license from SRS Labs, Inc.



Manufactured under license from Dolby Laboratories.
"Dolby" and the double-D symbol are trademarks of Dolby Laboratories.

FOR LCD TV

- If the TV feels cold to the touch, there may be a small "flicker" when it is turned on. This is normal, there is nothing wrong with TV.
- Some minute dot defects may be visible on the screen, appearing as tiny red, green, or blue spots. However, they have no adverse effect on the monitor's performance.
- Avoid touching the LCD screen or holding your finger(s) against it for long periods of time. Doing so may produce some temporary distortion effects on the screen.

On Disposal (Only Hg lamp used LCD TV)

The fluorescent lamp used in this product contains a small amount of mercury. Do not dispose of this product with general household waste. Disposal of this product must be carried out in accordance to the regulations of your local authority.

PREPARATION

ACCESSORIES

Ensure that the following accessories are included with your TV. If an accessory is missing, please contact the dealer where you purchased the TV.

The accessories included may differ from the images below.

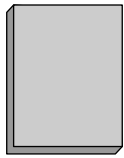

Owner's Manual



CD Manual

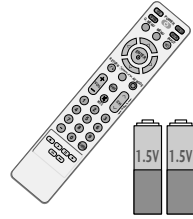

Remote Control,
Batteries



Power Cord

(Only 32/37/42LG30DC)



Bolts for stand assembly
(Refer to P.13)

(Only 32/42LG30DC)



Screw for stand fixing
(Refer to P.16)

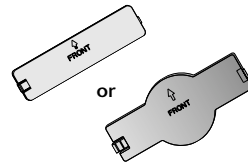

Protection Cover

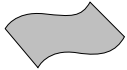

Polishing Cloth
(This feature is not available
for all models.)

- * Wipe spots on the exterior only with the polishing cloth.
- * Do not wipe roughly when removing stain. Excessive pressure may cause scratch or discoloration.

Option Extras

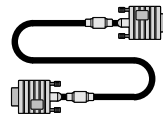

D-sub 15 pin Cable

When using the VGA (D-sub 15 pin cable) PC connection, the user must use shielded signal interface cables with ferrite cores to maintain standards compliance.

PREPARATION

FRONT PANEL INFORMATION

- Image shown may differ from your TV.
- **NOTE:** If your TV has a protection tape attached, remove the tape. And then wipe the TV with a cloth (If a polishing cloth is included with your TV, use it).

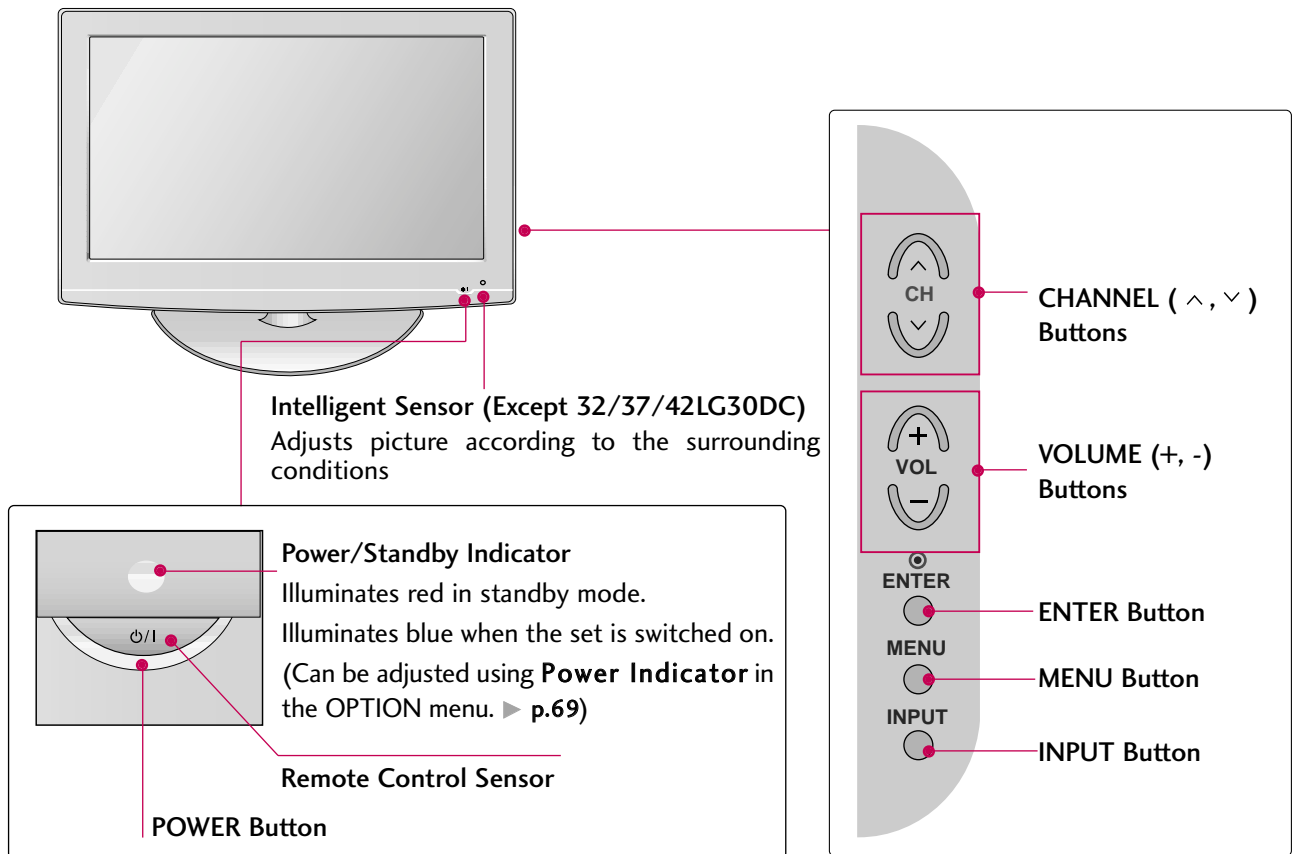

BACK PANEL INFORMATION

Image shown may differ from your TV.

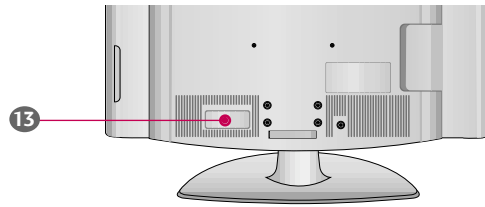

32/37/42LG30DC

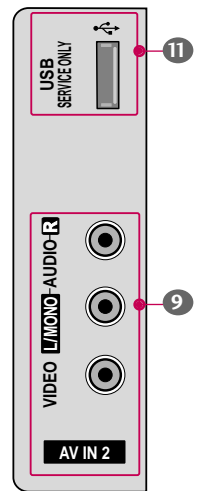
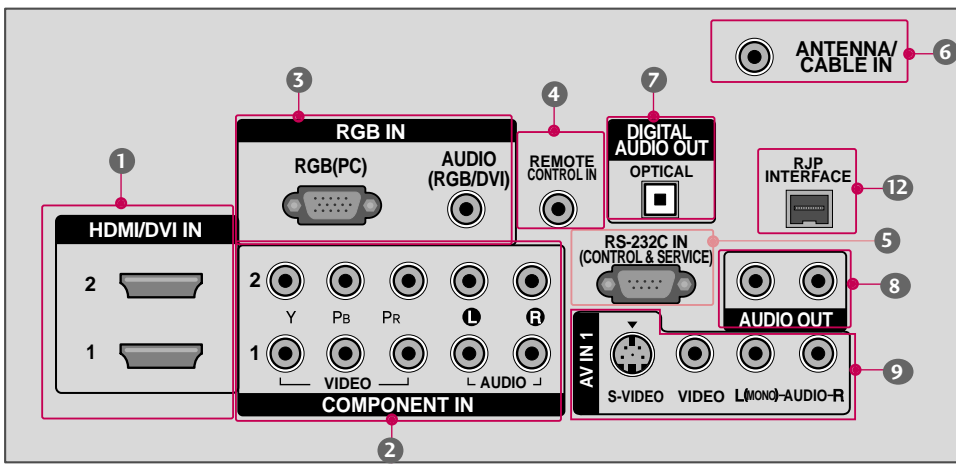

47/52LG50DC

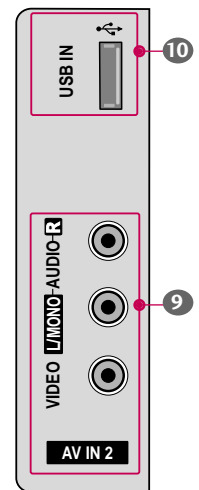
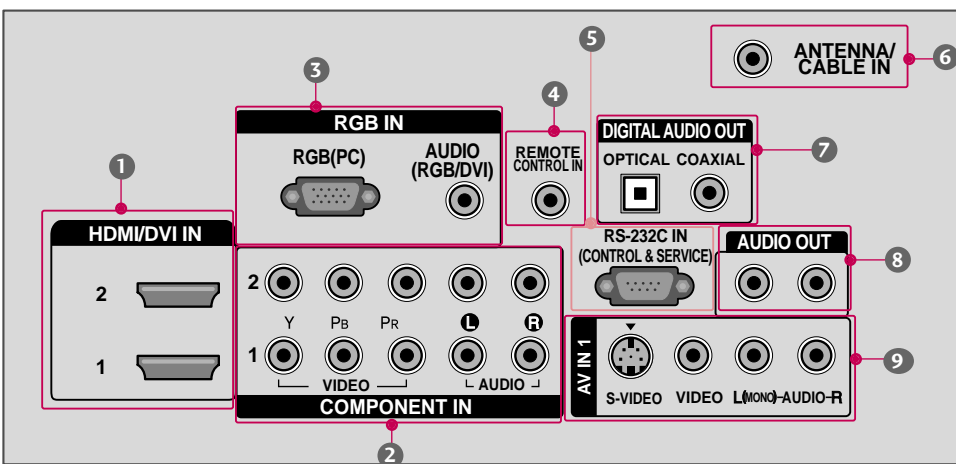

PREPARATION

1 HDMI/DVI IN, HDMI IN

Digital Connection.

Supports HD video and Digital audio. Doesn't support 480i.

Accepts DVI video using an adapter or HDMI to DVI cable (not included).

2 COMPONENT IN

Analog Connection.

Supports HD.

Uses a red, green, and blue cable for video & red and white for audio.

3 RGB (PC)

Analog PC Connection. Uses a D-sub 15 pin cable (VGA cable).

AUDIO (RGB/DVI)

1/8" headphone jack for analog PC audio input.

4 REMOTE CONTROL IN PORT

For a wired remote control.

5 RS-232C IN (CONTROL & SERVICE) PORT

Used by third party devices.

6 ANTENNA/CABLE IN

Connect over-the air signals to this jack.

Connect cable signals to this jack.

7 DIGITAL AUDIO OUT

Digital audio output for use with amps and home theater systems.

Includes an optical and/or coaxial connection.

Note: In standby mode, these ports do not work.

8 AUDIO OUT

Analog audio output for use with amps and home theater systems.

9 AV (Audio/Video) IN

Analog composite connection. Supports standard definition video only (480i).

S-VIDEO

Better quality than standard composition. Supports standard definition video only (480i).

10 USB INPUT

Used for viewing photos and listening to MP3s.

11 USB SERVICE ONLY

Used for software updates.

12 RJP INTERFACE

13 Power Cord Socket

For operation with AC power.

Caution: Never attempt to operate the TV on DC power.

STAND INSTRUCTION

■ Image shown may differ from your TV.

INSTALLATION (Only 32/37/42LG30DC)

- 1 Carefully place the TV screen side down on a cushioned surface to protect the screen from damage.

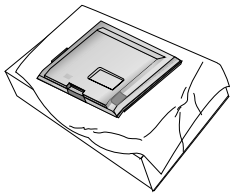

- 2 Assemble the parts of the **STAND BODY** with **COVER BASE** of the TV.

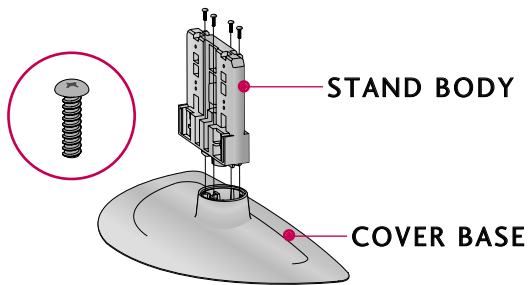

- 3 Assemble the TV as shown.

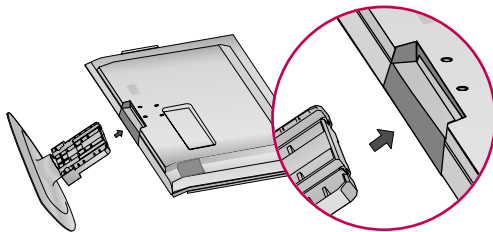

- 4 Fix the 4 bolts securely using the holes in the back of the TV.

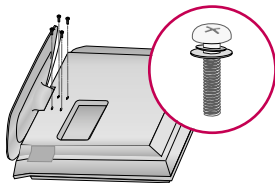

! NOTE

- ▶ When assembling the desk type stand, make sure the bolt is fully tightened (If not tightened fully, the TV can tilt forward after the product installation). Do not over tighten.

DETACHMENT

- 1 Carefully place the TV screen side down on a cushioned surface to protect the screen from damage.

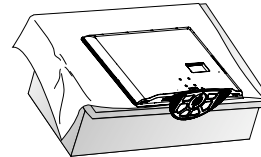

- 2 Loose the bolts from TV.

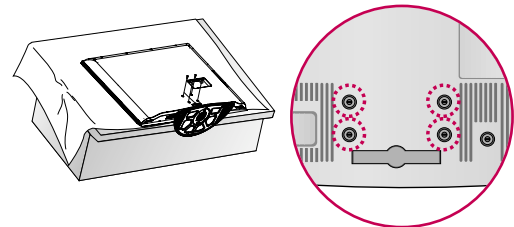

- 3 Detach the stand from TV.

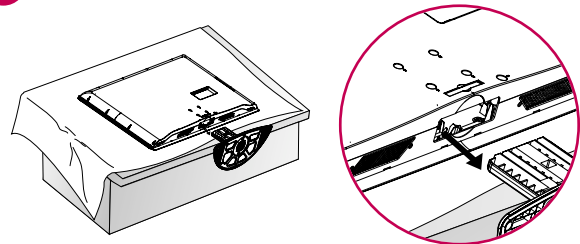

PROTECTION COVER

After removing the stand, install the included **protection cover** over the hole for the stand. Press the **PROTECTION COVER** into the TV until you hear it click.

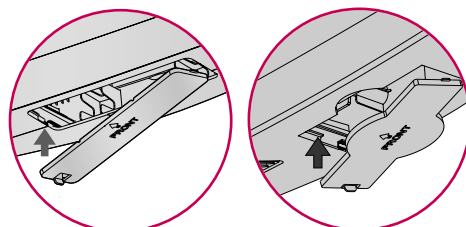
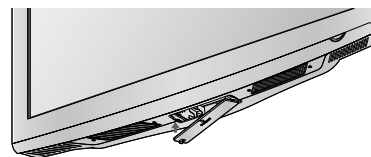

PREPARATION

VESA WALL MOUNTING

Install your wall mount on a solid wall perpendicular to the floor. When attaching to other building materials, please contact your nearest dealer.

If installed on a ceiling or slanted wall, it may fall and result in severe personal injury.

We recommend that you use an LG brand wall mount when mounting the TV to a wall.

LG recommends that wall mounting be performed by a qualified professional installer.

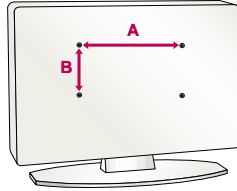

Product	Model	VESA (A * B)	Standard Screw	Quantity
LCD TV	32LG30DC	200 * 100	M4	4
	37LG30DC	200 * 200	M6	4
	42LG30DC			
	47LG50DC			
	52LG50DC	800 * 400	M6	4

NOTE

- ▶ Screw length needed depends on the wall mount used. For further information, refer to the instructions included with the mount.
- ▶ Standard dimensions for wall mount kits are shown in the table.
- ▶ When purchasing our wall mount kit, a detailed installation manual and all parts necessary for assembly are provided.
- ▶ Do not use screws longer than the standard dimension, as they may cause damage to the inside to the TV.
- ▶ For wall mounts that do not comply with the VESA standard screw specifications, the length of the screws may differ depending on their specifications.
- ▶ Do not use screws that do not comply with the VESA standard screw specifications.
- ▶ Do not use fasten the screws too strongly, this may damage the TV or cause the TV to a fall, leading to personal injury. LG is not liable for these kinds of accidents.
- ▶ LG is not liable for TV damage or personal injury when a non-VESA or non specified wall mount is used or the consumer fails to follow the TV installation instructions.

CAUTION

- ▶ Do not install your wall mount kit while your TV is turned on. It may result in personal injury due to electric shock.

CABLE MANAGEMENT

■ Image shown may differ from your TV.

- 1 Connect the cables as necessary. To connect additional equipment, see the **EXTERNAL EQUIPMENT SETUP** section.

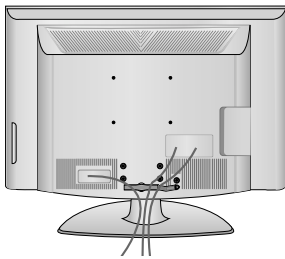

- 2 Install the **CABLE MANAGEMENT CLIP** as shown.

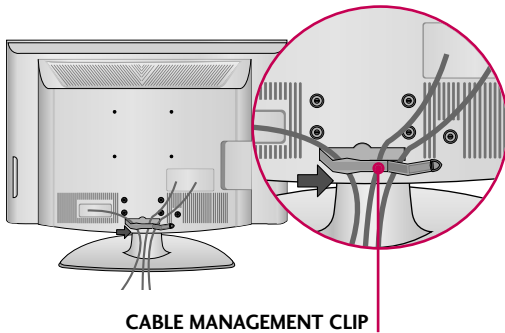

- 3 Put the cables inside the **CABLE MANAGEMENT CLIP** and snap it closed.

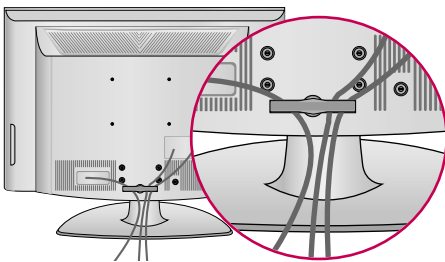

DESKTOP PEDESTAL INSTALLATION

■ Image shown may differ from your TV.

For proper ventilation, allow a clearance of 4 inches on all four sides from the wall.

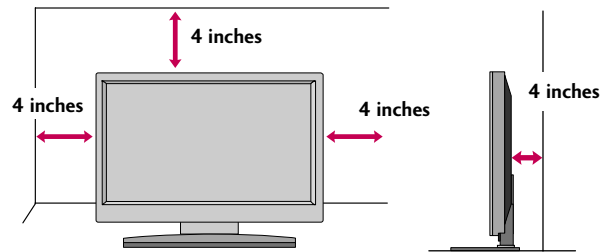

⚠ CAUTION

- ▶ Ensure adequate ventilation by following the clearance recommendations.
- ▶ Do not mount near or above any type of heat source.

SWIVEL STAND

After installing the TV, you can adjust the TV set manually to the left or right direction by 20 degrees to suit your viewing position.

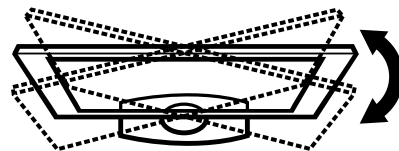

PREPARATION

ATTACHING THE TV TO A DESK

The TV must be attached to a desk so it cannot be pulled in a forward/backward direction, potentially causing injury or damaging the product.

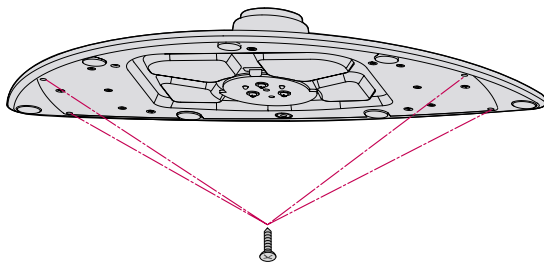

4-Screws
(not provided as parts of the product)

- ▶ Screw: M5 x L (*L: Table depth + 8~10 mm)
ex) Table depth: 15mm, Screw: M5 x 25

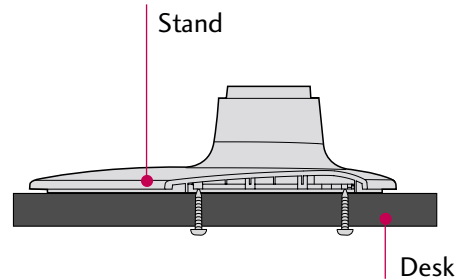

Only 32/42LG30DC

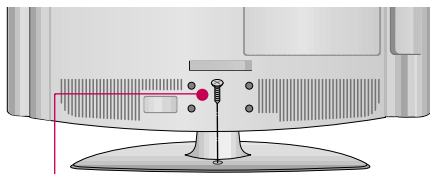

1-Screw
(provided as parts of the product)

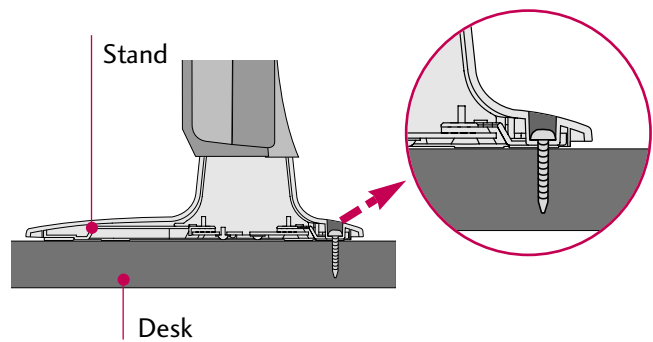

⚠ WARNING

- ▶ To prevent TV from falling over, the TV should be securely attached to the floor/wall per installation instructions. Tipping, shaking, or rocking the machine may cause injury.

SECURING THE TV TO THE WALL TO PREVENT FALLING WHEN THE TV IS USED ON A STAND

- You should purchase necessary components to prevent TV from falling off of the stand.
- Image shown may differ from your TV.

We recommend that you set up the TV close to a wall so it cannot fall over if pushed backwards. Additionally, we recommend that the TV be attached to a wall so it cannot be pulled in a forward direction, potentially causing injury or damaging the product.

Caution: Please make sure that children don't climb on or hang from the TV.

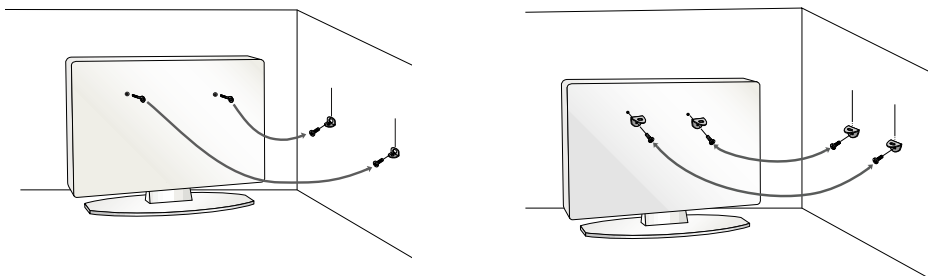

- Insert the eye-bolts (or TV brackets and bolts) to tighten the product to the wall as shown in the picture.

* If your product has the bolts in the eye-bolts position before inserting the eye-bolts, loosen the bolts.

* Insert the eye-bolts or TV brackets/bolts and tighten them securely in the upper holes.

Secure the wall brackets with the bolts (sold separately) to the wall. Match the height of the bracket that is mounted on the wall to the holes in the product.

Ensure the eye-bolts or brackets are tightened securely.

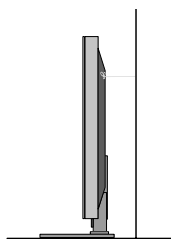

- Use a sturdy rope or cord (sold separately) to tie the product. It is safer to tie the rope so it becomes horizontal between the wall and the product.

! NOTE

- ▶ Use a platform or cabinet strong enough and large enough to support the size and weight of the TV.
- ▶ To use the TV safely make sure that the height of the bracket on the wall and the one on the TV are the same.

PREPARATION

- To prevent damage do not connect to the power outlet until all connections are made between the devices.

ANTENNA OR CABLE CONNECTION

PREPARATION

1. Antenna (Analog or Digital)

Wall Antenna Socket or Outdoor Antenna without a Cable Box Connection.

For optimum picture quality, adjust the antenna direction if needed.

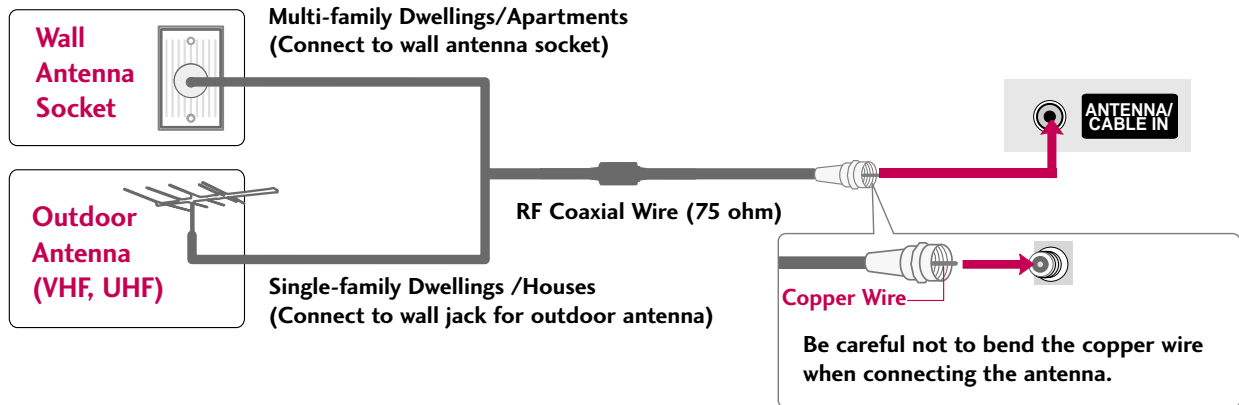

2. Cable

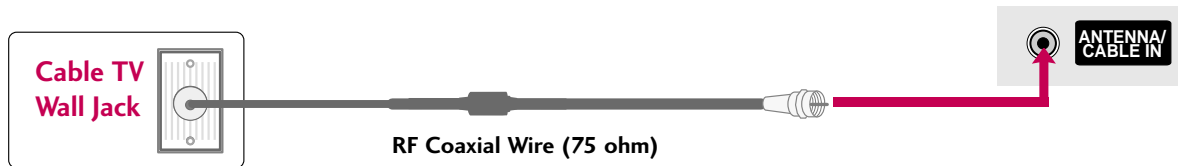

- To improve the picture quality in a poor signal area, please purchase a signal amplifier and install properly.
- If the antenna needs to be split for two TV's, install a 2-Way Signal Splitter.
- If the antenna is not installed properly, contact your dealer for assistance.

EXTERNAL EQUIPMENT SETUP

- To prevent the equipment damage, never plug in any power cords until you have finished connecting all equipment.
- Image shown may differ from your TV.

HD RECEIVER SETUP

This TV can receive digital over-the-air/digital cable signals without an external digital set-top box. However, if you do receive digital signals from a digital set-top box or other digital external device.

Component Connection

1. How to connect

- 1 Connect the video outputs (Y, PB, PR) of the digital set-top box to the **COMPONENT IN VIDEO 1** jacks on the TV. Match the jack colors (Y = green, PB = blue, and PR = red).
- 2 Connect the audio output of the digital set-top box to the **COMPONENT IN AUDIO 1** jacks on the TV.

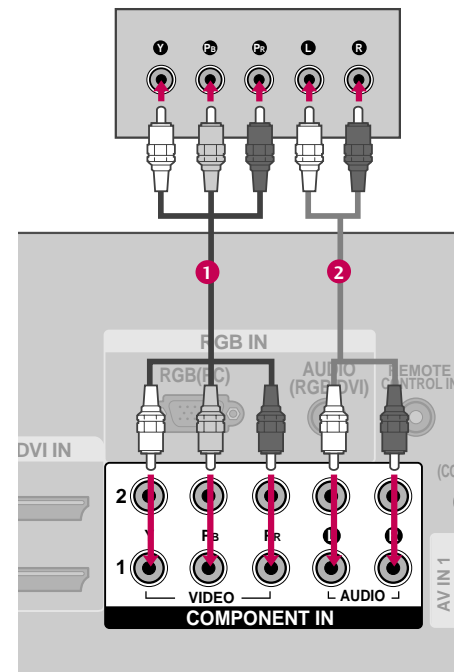

2. How to use

- Turn on the digital set-top box.
(Refer to the owner's manual for the digital set-top box operation)
- Select the **Component 1** input source on the TV using the **INPUT** button on the remote control.
- If connected to **COMPONENT IN2** input, select the **Component 2** input source on the TV.

Supported Resolutions

Signal	Component	HDMI
480i	Yes	No
480p	Yes	Yes
720p	Yes	Yes
1080i	Yes	Yes
1080p	Yes	Yes

Y, Cb/Pb, Cr/Pr

Resolution	Horizontal Frequency(KHz)	Vertical Frequency(Hz)
720x480i	15.73	59.94
	15.73	60.00
720x480p	31.47	59.94
	31.50	60.00
1280x720p	44.96	59.94
	45.00	60.00
1920x1080i	33.72	59.94
	33.75	60.00
1920x1080p	26.97	23.976
	27.00	24.00
	33.71	29.97
	33.75	30.00
	67.432	59.94
	67.50	60.00

EXTERNAL EQUIPMENT SETUP

HDMI Connection

1. How to connect

- 1 Connect the digital set-top box to **HDMI/DVI IN1** or **2** jack on the TV.
- 2 No separate audio connection is necessary. HDMI supports both audio and video.

2. How to use

- Turn on the digital set-top box.
(Refer to the owner's manual for the digital set-top box.)
- Select the **HDMI1** or **HDMI2** input source on the TV using the **INPUT** button on the remote control.

HDMI-DTV

Resolution	Horizontal Frequency(KHz)	Vertical Frequency(Hz)
720x480p	31.47	59.94
	31.50	60.00
1280x720p	44.96	59.94
	45.00	60.00
1920x1080i	33.72	59.94
	33.75	60.00
1920x1080p	26.97	23.976
	27.00	24.00
	33.71	29.97
	33.75	30.00
	67.432	59.939
	67.50	60.00

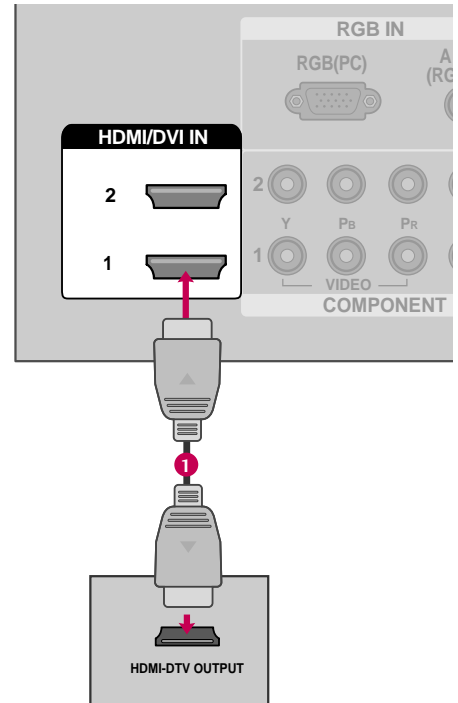

DVI to HDMI Connection

1. How to connect

- 1 Connect the DVI output of the digital set-top box to the **HDMI/DVI IN 1** or **2** jack on the TV.
- 2 Connect the PC audio output to the **AUDIO (RGB/DVI)** jack on the TV.

2. How to use

- Turn on the digital set-top box. (Refer to the owner's manual for the digital set-top box.)
- Select the **HDMI1** or **HDMI2** input source on the TV using the **INPUT** button on the remote control.

! NOTE

- ▶ A DVI to HDMI cable or adapter is required for this connection. DVI doesn't support audio, so a separate audio connection is necessary.

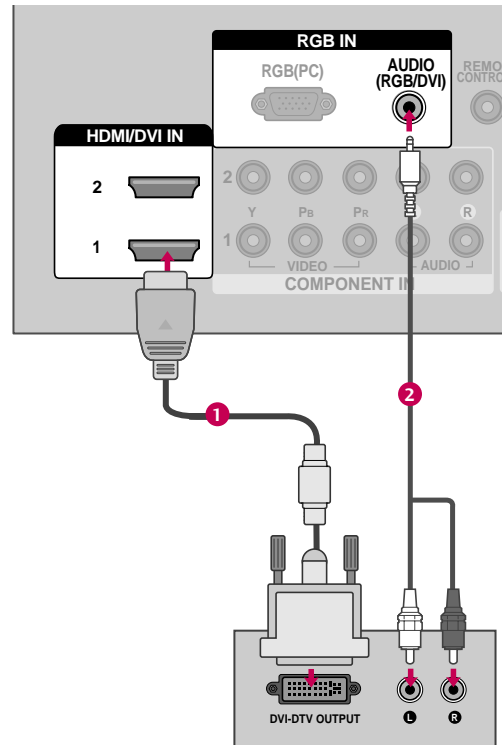

EXTERNAL EQUIPMENT SETUP

DVD SETUP

Component Connection

1. How to connect

- 1 Connect the video outputs (Y, PB, PR) of the DVD to the **COMPONENT IN VIDEO1** jacks on the TV.
Match the jack colors (Y = green, PB = blue, and PR = red).
- 2 Connect the audio outputs of the DVD to the **COMPONENT IN AUDIO1** jacks on the TV.

2. How to use

- Turn on the DVD player, insert a DVD.
- Select the **Component 1** input source on the TV using the **INPUT** button on the remote control.
- If connected to **COMPONENT IN 2** input, select the **Component 2** input source on the TV.
- Refer to the DVD player's manual for operating instructions.

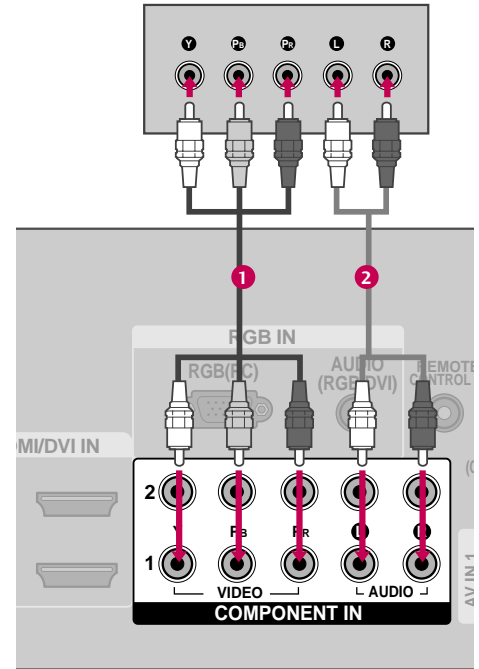

Component Input ports

To get better picture quality, connect a DVD player to the component input ports as shown below.

Component ports on the TV	Y	P _B	P _R
Video output ports on DVD player	Y	P _B	P _R
	Y	B-Y	R-Y
	Y	C _b	C _r
	Y	P _b	P _r

S-Video Connection

1. How to connect

- 1 Connect the S-VIDEO output of the DVD to the S-VIDEO input on the TV.
- 2 Connect the audio outputs of the DVD to the AUDIO input jacks on the TV.

2. How to use

- Turn on the DVD player, insert a DVD.
- Select the **AV1** input source on the TV using the **INPUT** button on the remote control.
- Refer to the DVD player's manual for operating instructions.

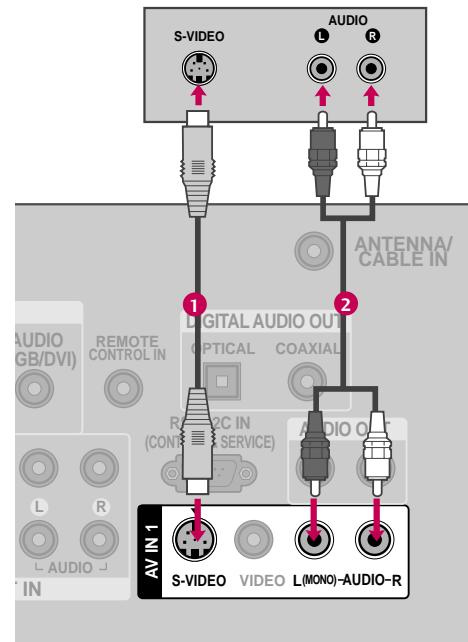

HDMI Connection

1. How to connect

- 1 Connect the HDMI output of the DVD to the HDMI/DVI IN1 or 2 jack on the TV.
- 2 No separate audio connection is necessary. HDMI supports both audio and video.

2. How to use

- Select the **HDMI1** or **HDMI2** input source on the TV using the **INPUT** button on the remote control.
- Refer to the DVD player's manual for operating instructions.

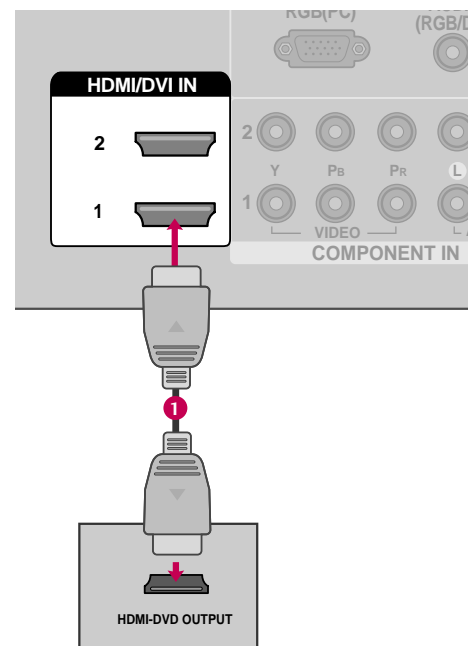

EXTERNAL EQUIPMENT SETUP

VCR SETUP

- To avoid picture noise (interference), leave an adequate distance between the VCR and TV.
- If the 4:3 picture format is used; the fixed images on the sides of the screen may remain visible on the screen. This phenomenon is common to all TVs and is not covered by warranty.

Antenna Connection

1. How to connect

- 1 Connect the RF antenna out socket of the VCR to the **ANTENNA/CABLE IN** socket on the TV.
- 2 Connect the antenna cable to the RF antenna in socket of the VCR.

2. How to use

- Set VCR output switch to 3 or 4 and then tune TV to the same channel number.
- Insert a video tape into the VCR and press PLAY on the VCR. (Refer to the VCR owner's manual.)

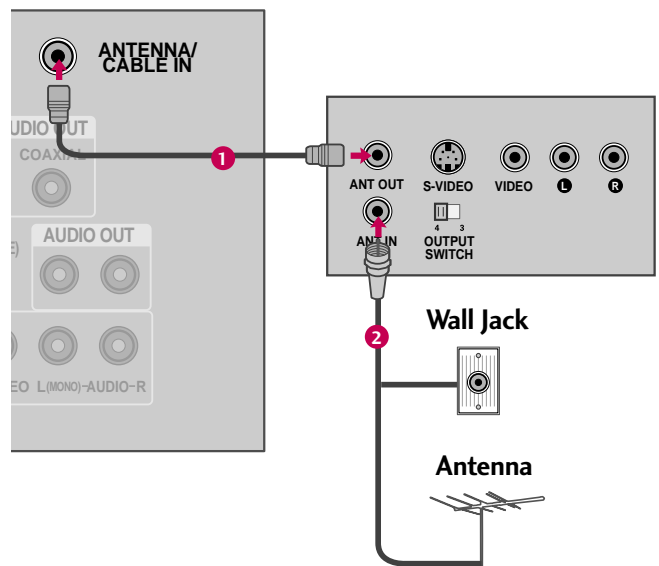

Composite (RCA) Connection

1. How to connect

- 1 Connect the **AUDIO/VIDEO** jacks between TV and VCR. Match the jack colors (Video = yellow, Audio Left = white, and Audio Right = red)

2. How to use

- Insert a video tape into the VCR and press PLAY on the VCR. (Refer to the VCR owner's manual.)
- Select the **AV1** input source on the TV using the **INPUT** button on the remote control.
- If connected to **AV IN2**, select **AV2** input source on the TV.

NOTE

- ▶ If you have a mono VCR, connect the audio cable from the VCR to the **AUDIO L/MONO** jack of the TV.

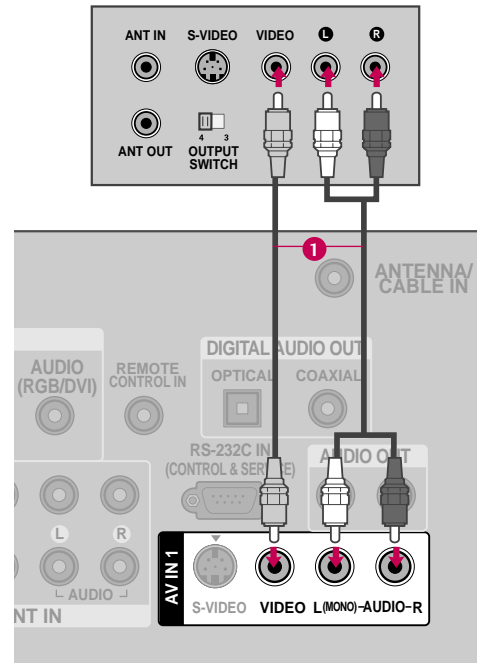

S-Video Connection

1. How to connect

- 1 Connect the S-VIDEO output of the VCR to the S-VIDEO input on the TV.
- 2 Connect the audio outputs of the VCR to the **AUDIO** input jacks on the TV.

2. How to use

- Insert a video tape into the VCR and press PLAY on the VCR. (Refer to the VCR owner's manual.)
- Select the **AV1** input source on the TV using the **INPUT** button on the remote control.

CAUTION

- ▶ Do not connect to both Video and S-Video at the same time. In the event that you connect both Video and the S-Video cables, only the S-Video will work.

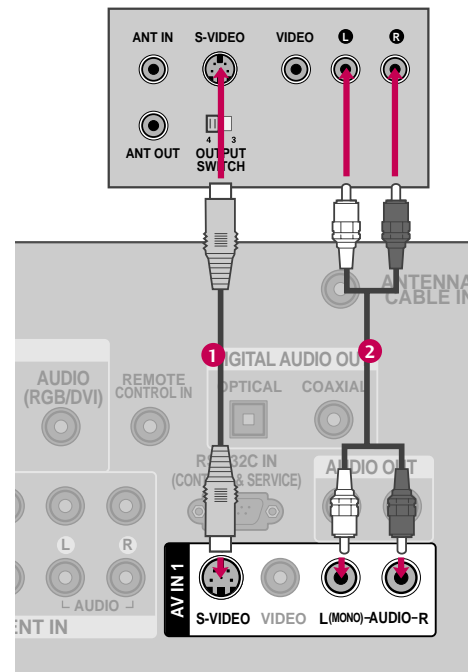

NOTE

- ▶ S-Video provides better quality than composite. Use it when available.

EXTERNAL EQUIPMENT SETUP

PC SETUP

This TV provides Plug and Play capability, meaning that the PC adjusts automatically to the TV's settings.

VGA (D-Sub 15 pin) Connection

1. How to connect

- 1 Connect the VGA output of the PC to the **RGB (PC)** jack on the TV.
- 2 Connect the PC audio output to the **AUDIO (RGB/DVI)** jack on the TV.

2. How to use

- Turn on the PC and the TV.
- Select the **RGB-PC** input source on the TV using the **INPUT** button on the remote control.

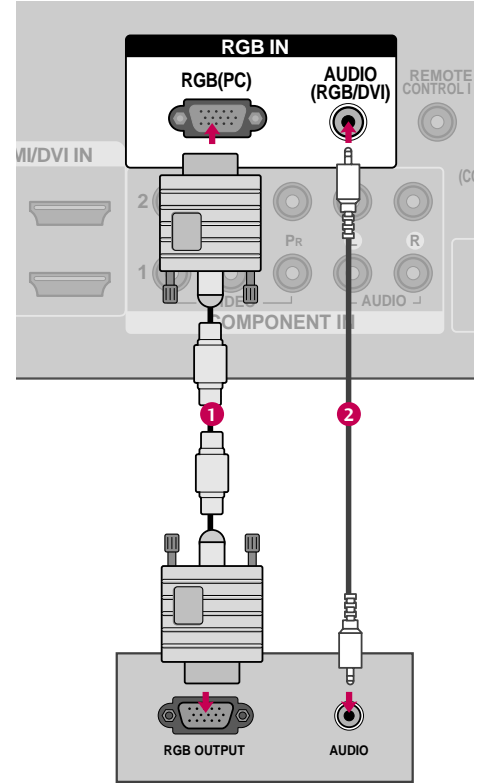

DVI to HDMI Connection

1. How to connect

- 1 Connect the DVI output of the PC to the **HDMI/DVI IN 1 or 2** jack on the TV.
- 2 Connect the PC audio output to the **AUDIO (RGB/DVI)** jack on the TV.

2. How to use

- Turn on the PC and the TV.
- Select the **HDMI1** or **HDMI2** input source on the TV using the **INPUT** button on the remote control.

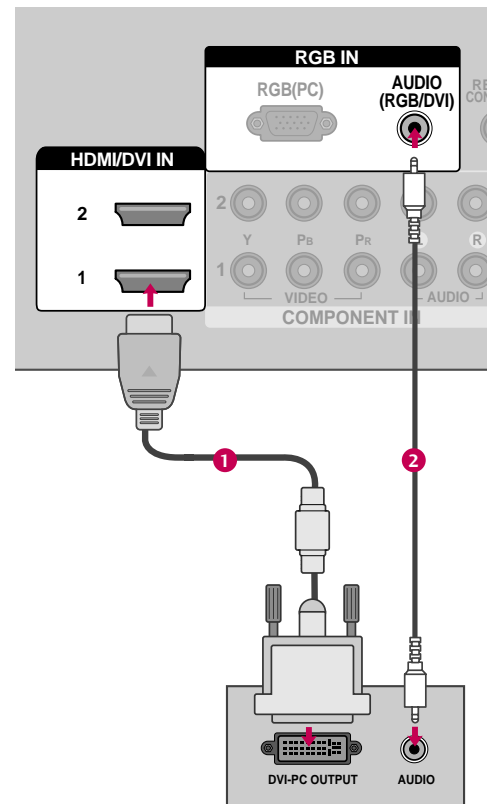

! NOTES

- ▶ 32/37/42LG30DC: To get the the best picture quality, adjust the PC graphics card to 1360x768.
- ▶ 47/52LG50DC: To get the the best picture quality, adjust the PC graphics card to 1920x1080.
- ▶ Depending on the graphics card, DOS mode may not work if a HDMI to DVI Cable is in use.
- ▶ In PC mode, there may be noise associated with the resolution, vertical pattern, contrast or brightness. If noise is present, change the PC output to another resolution, change the refresh rate to another rate or adjust the brightness and contrast on the PICTURE menu until the picture is clear.
- ▶ Avoid keeping a fixed image on the screen for a long period of time. The fixed image could become permanently imprinted on the screen.
- ▶ The synchronization input form for Horizontal and Vertical frequencies is separate.
- ▶ Depending on the graphics card, some resolution settings may not allow the image to be positioned on the screen properly.
- ▶ If there are overscan in HDMI-PC 1920x1080, change aspect ratio to **Just scan**.

Supported Display Specifications (RGB-PC, HDMI-PC)**For 32/37/42LG30DC**

Resolution	Horizontal Frequency(KHz)	Vertical Frequency(Hz)
640x350	31.469	70.08 ●
720x400	31.469	70.08 ●
640x480	31.469	59.94
800x600	37.879	60.31
1024x768	48.363	60.00
1280x768	47.776	59.87
1360x768	47.720	59.799
1366x768	47.130	59.65

* Only RGB-PC mode

For 47/52LG50DC

Resolution	Horizontal Frequency(KHz)	Vertical Frequency(Hz)
640x350	31.468	70.09
720x400	31.469	70.08
640x480	31.469	59.94
	37.500	75.00
800x600	37.861	72.80
	35.156	56.25
	37.879	60.31
1024x768	46.875	75.00
	48.077	72.18
1024x768	48.363	60.00
	56.476	70.06
	60.023	75.02
1280x768	47.776	59.87
	60.289	74.893 ●
1280x1024	63.981	60.02
	79.976	75.025
1360x768	47.712	60.015
1600x1200	75.00	60.00
1920x1080	RGB-PC 66.587	59.934
	HDMI-PC 67.5	60.00

* Only RGB-PC mode

EXTERNAL EQUIPMENT SETUP

Screen Setup for PC mode







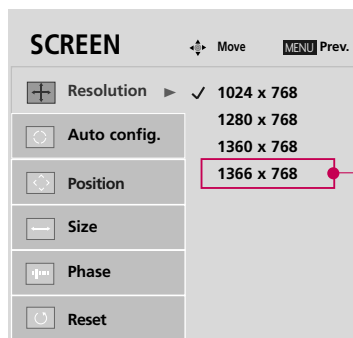
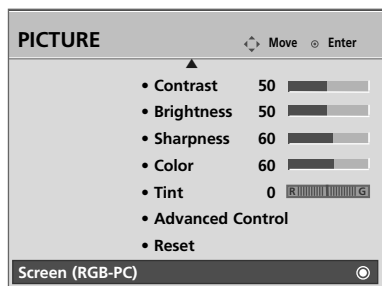

Selecting Resolution

You can choose the resolution in RGB-PC mode.

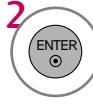
The **Position**, **Phase**, and **Size** can also be adjusted.

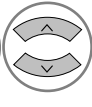

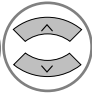







Only for
32/37/42LG30DC

-   Select **PICTURE**.
-   Select **Screen (RGB-PC)**.
-   Select **Resolution**.
-   Select the desired resolution.
- 

Auto Configure

Automatically adjusts picture position and minimizes image instability. After adjustment, if the image is still not correct, try using the manual settings or a different resolution or refresh rate on the PC.



- 1   Select **PICTURE**.
- 2   Select **Screen (RGB-PC)**.
- 3   Select **Auto config.**
- 4   Select **Yes**.
- 5  Start Auto Configuration.

- If the position of the image is still not correct, try Auto adjustment again.
- If picture needs to be adjusted again after Auto adjustment in RGB-PC, you can adjust the **Position**, **Size** or **Phase**.







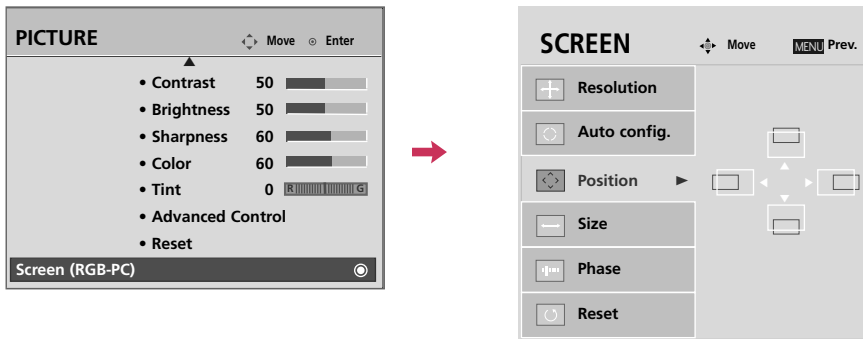

EXTERNAL EQUIPMENT SETUP

Adjustment for screen Position, Size, and Phase

If the picture is not clear after auto adjustment and especially if characters are still trembling, adjust the picture phase manually.

This feature operates only in RGB-PC mode.











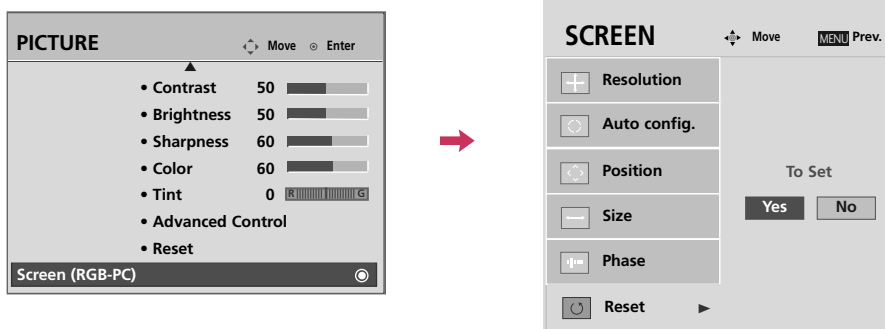

- 1   Select **PICTURE**.
- 2   Select **Screen (RGB-PC)**.
- 3   Select **Position, Size, or Phase**.
- 4   Make appropriate adjustments.
- 5 

- **Position:** This function is to adjust picture to left/right and up/down as you prefer.
- **Size:** This function is to minimize any vertical bars or stripes visible on the screen background. And the horizontal screen size will also change.
- **Phase:** This function allows you to remove any horizontal noise and clear or sharpen the image of characters.

Screen Reset (Reset to original factory values)

Returns **Position**, **Size**, and **Phase** to the default factory settings.
This feature operates only in RGB-PC mode.



- 1   Select **PICTURE**.
- 2   Select **Screen (RGB-PC)**.
- 3   Select **Reset**.
- 4   Select **Yes**.
- 5 

EXTERNAL EQUIPMENT SETUP

USB CONNECTION (Except 32/37/42LG30DC)

1. How to connect

- 1 Connect the USB device to the **USB IN** jack on the side of TV.

2. How to use

- After connecting the **USB IN** jack, you use the USB function. (▶ p.50)

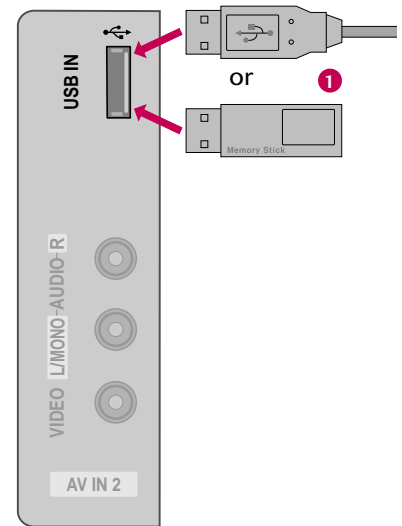

OTHER A/V SOURCE SETUP

1. How to connect

- 1 Connect the **AUDIO/VIDEO** jacks between TV and external equipment. Match the jack colors.
(Video = yellow, Audio Left = white, and Audio Right = red)

2. How to use

- Select the **AV2** input source on the TV using the **INPUT** button on the remote control.
- If connected to **AV IN1** input, select the **AV1** input source on the TV.
- Operate the corresponding external equipment.

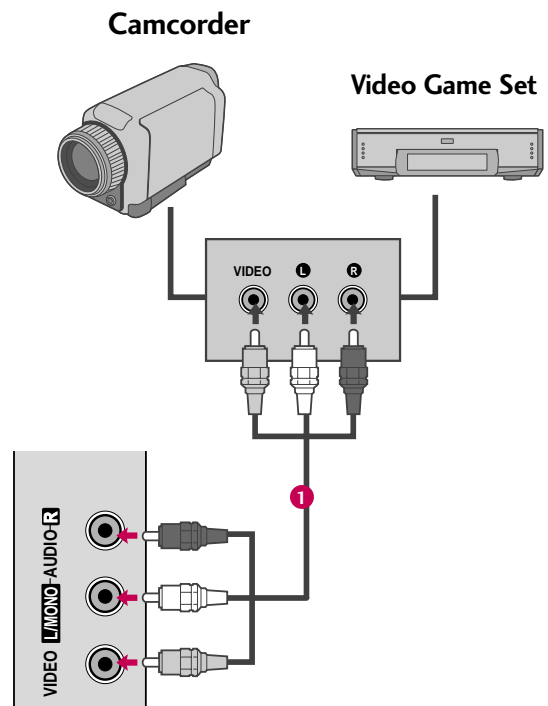

AUDIO OUT CONNECTION

Send the TV's audio to external audio equipment via the Audio Output port.

Analog

1. How to connect

- 1 Connect audio outputs to the TV's **AUDIO OUT** jacks.
- 2 Set the "TV Speaker option - Off" in the AUDIO menu. (▶ p.75). See the external audio equipment instruction manual for operation.

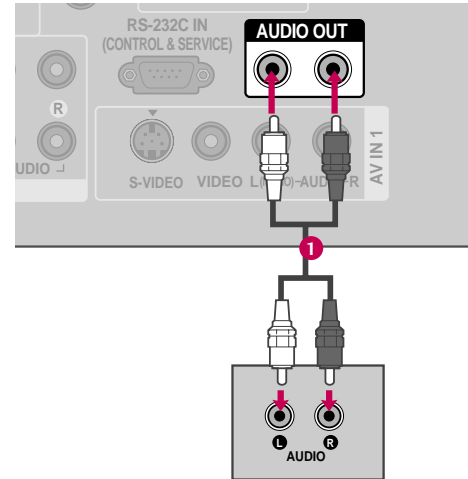

Digital

1. How to connect

- 1 Connect one end of the optical or coaxial cable to the TV's **OPTICAL** or **COAXIAL** (Except 32/37/42LG30DC) port of **DIGITAL AUDIO OUT**.
- 2 Connect the other end of the optical or coaxial cable to the digital audio input on the audio equipment.
- 3 Set the "TV Speaker option - Off" in the AUDIO menu. (▶ p.75). See the external audio equipment instruction manual for operation.

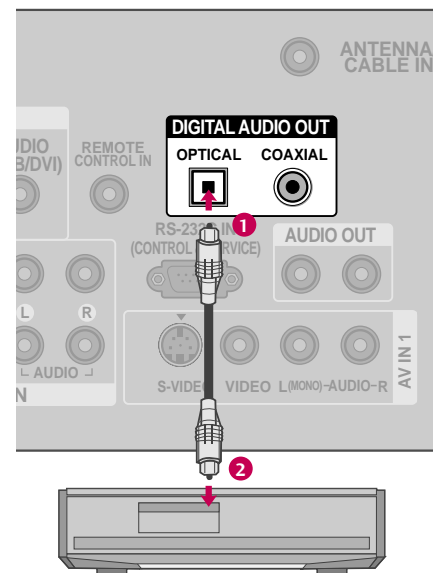

! NOTE

- ▶ When connecting with external audio equipments, such as amplifiers or speakers, you can turn the TV speakers off in the menu. (▶ p.75)

! CAUTION

- ▶ Do not look into the optical output port. Looking at the laser beam may damage your vision.
- ▶ Block the SPDIF out (optical/coaxial) about the contents with ACP(Audio Copy Protection) function.

WATCHING TV / CHANNEL CONTROL

REMOTE CONTROL FUNCTIONS

When using the remote control, aim it at the remote control sensor on the TV.

TV/STB/DVD/VCR Select the remote operating mode: TV, STB, DVD, or VCR.

POWER Turns your TV or any other programmed equipment on or off, depending on the mode.

Q.MENU Select the desired quick menu source. ▶ p.37

MENU Displays the main menu.
Clear all on-screen displays and return to TV viewing from any menu.

INPUT External input modes rotate in regular sequence.

VOLUME UP / DOWN Increase/decrease the sound level.

FAV Scroll through the programmed Favorite channels. ▶ p.37

MUTE Switch the sound on or off. ▶ p.36

CHANNEL UP/DOWN Select available channels.

PAGE UP/DOWN Move from one full set of screen information to the next one.

NUMBER button

— (DASH) Used to enter a program number for multiple program channels such as 2-1, 2-2, etc.

FLASHBK Tune to the last channel viewed.

VCR/DVD, USB, SIMPLINK Control buttons

- Control video cassette recorders or DVD players.
- Control USB menu (PHOTO LIST and MUSIC LIST.)
- Control the SIMPLINK compatible devices.

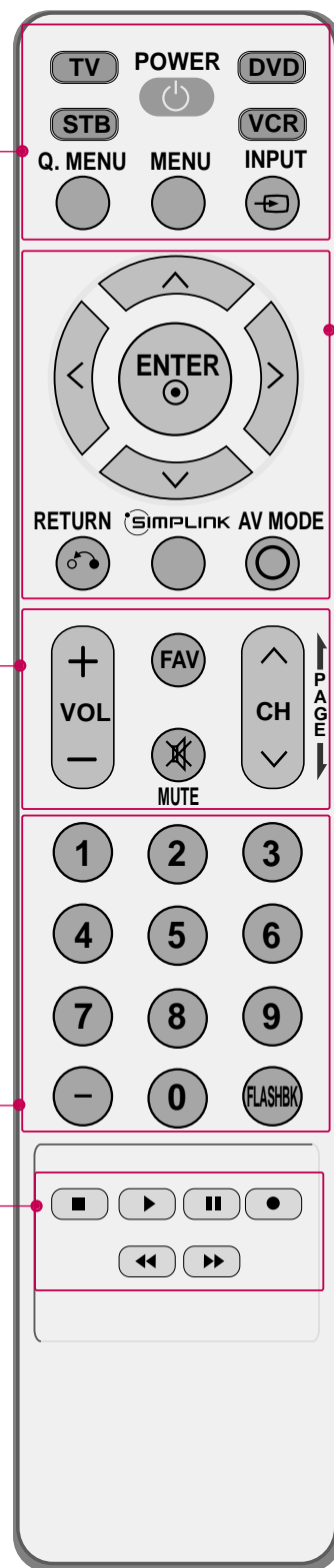

THUMBSTICK (Up/Down/Left Right/ENTER) Navigate the on-screen menus and adjust the system settings to your preference.

RETURN Allows the user to move return one step in an interactive application or other user interaction function.

SIMPLINK See a list of AV devices connected to TV.
When you toggle this button, the SIMPLINK menu appears at the screen. ► p.48-49

AV MODE It helps you select and set images and sounds. ► p.47

Installing Batteries

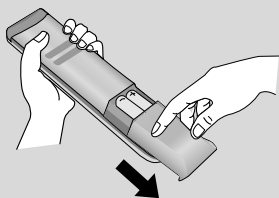

- Open the battery compartment cover on the back side and install the batteries matching correct polarity (+with +,-with -).
- Install two 1.5V AAA batteries. Don't mix old or used batteries with new ones.
- Close cover.

WATCHING TV / CHANNEL CONTROL

TURNING ON THE TV

- 1** First, connect power cord correctly.
At this moment, the TV switches to standby mode.
 - In standby mode to turn TV on, press the $\phi/1$, **INPUT**, **CH** (^ or v) button on the TV or press the **POWER**, **INPUT**, **CH**(^ or v), **Number (0~9)** button on the remote control.
 - 2** Select the viewing source by using the **INPUT** button on the remote control.
 - This TV is programmed to remember which power state it was last set to, even if the power cord is out.
 - 3** When finished using the TV, press the **POWER** button on the remote control. The TV reverts to standby mode.
-

! NOTE

- ▶ If you intend to be away on vacation, disconnect the power plug from the wall power outlet.

CHANNEL SELECTION

- 1** Press the **CH** (^ or v) or **NUMBER** buttons to select a channel number.
-

VOLUME ADJUSTMENT

Adjust the volume to suit your personal preference.

- 1** Press the **VOL** (+ or -) button to adjust the volume.
 - 2** If you want to switch the sound off, press the **MUTE** button.
 - 3** You can cancel the Mute function by pressing the **MUTE** or **VOL** (+ or -) button.
-

QUICK MENU



Your TV's OSD (On Screen Display) may differ slightly from what is shown in this manual.

Q.Menu (Quick Menu) is a menu of features which users might use frequently.

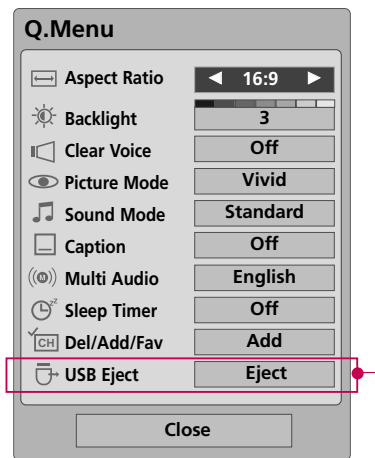
- **Aspect Ratio:** Selects your desired picture format.
- **Backlight:** Adjust the brightness of LCD panel to control the brightness of the screen.
- **Clear Voice:** By differentiating the human sound range from others, it helps make human voices sound better.
- **Picture Mode:** Selects the factory preset picture depend on the viewing environment.
- **Sound Mode:** Selects the factory preset sound for type of program.
- **Caption:** Select on or off.
- **Multi Audio:** Changes the audio language (Digital signal).
SAP: Selects MTS sound (Analog signal).
- **Sleep Timer:** Select the amount of time before your TV turns off automatically.
- **Del/Add/Fav:** Select channel you want to add/delete or add the channel to the Favorite List.
- **USB Eject:** Select "USB Eject" in order to eject USB device.



Except 32/37/42LG30DC

1   Display each menu.

2  Make appropriate adjustments.

3  Return to TV viewing.

WATCHING TV / CHANNEL CONTROL

INITIAL SETTING

This Function guides the user to easily set the essential items for viewing the TV for the first time when purchasing the TV. It will be displayed on the screen when turning the TV on for the first time. It can also be activated from the user menus.

- Default selection is “**Home**”. We recommend setting the TV to “**Home**” mode for the best picture in your home environment.
- “**In-store**” Mode is only intended for use in retail environments. Customers can adjust the “**Picture menu - Picture mode**” manually while inspecting the TV, but the TV will automatically return to preset in-store mode after 5 minutes.

Step1. Mode setting

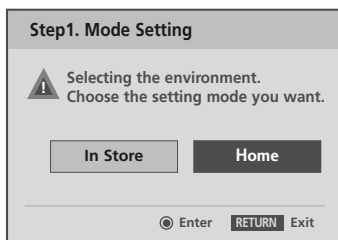

Step2. Time setting

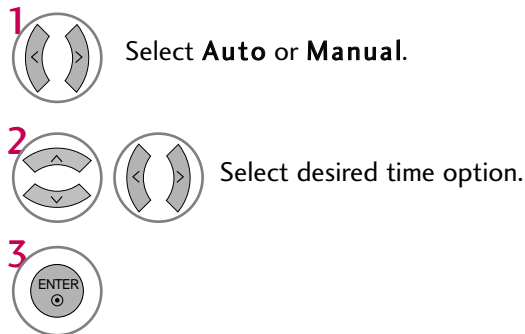

Step3. Option setting

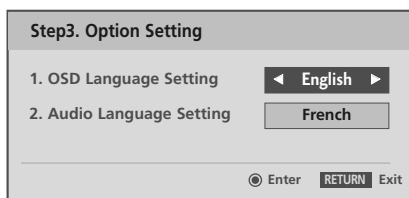

1 Select **OSD Language Setting** or **Audio Language Setting**.

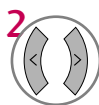

2 Select your desired language.



Step4. Auto Tuning

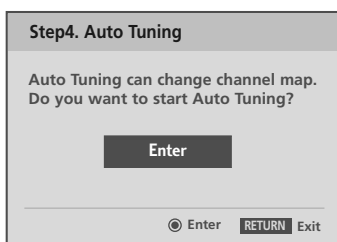

1 Start **Auto Tuning**.

! NOTE

- You can also adjust **Initial Setting** in the **OPTION** menu.

WATCHING TV / CHANNEL CONTROL





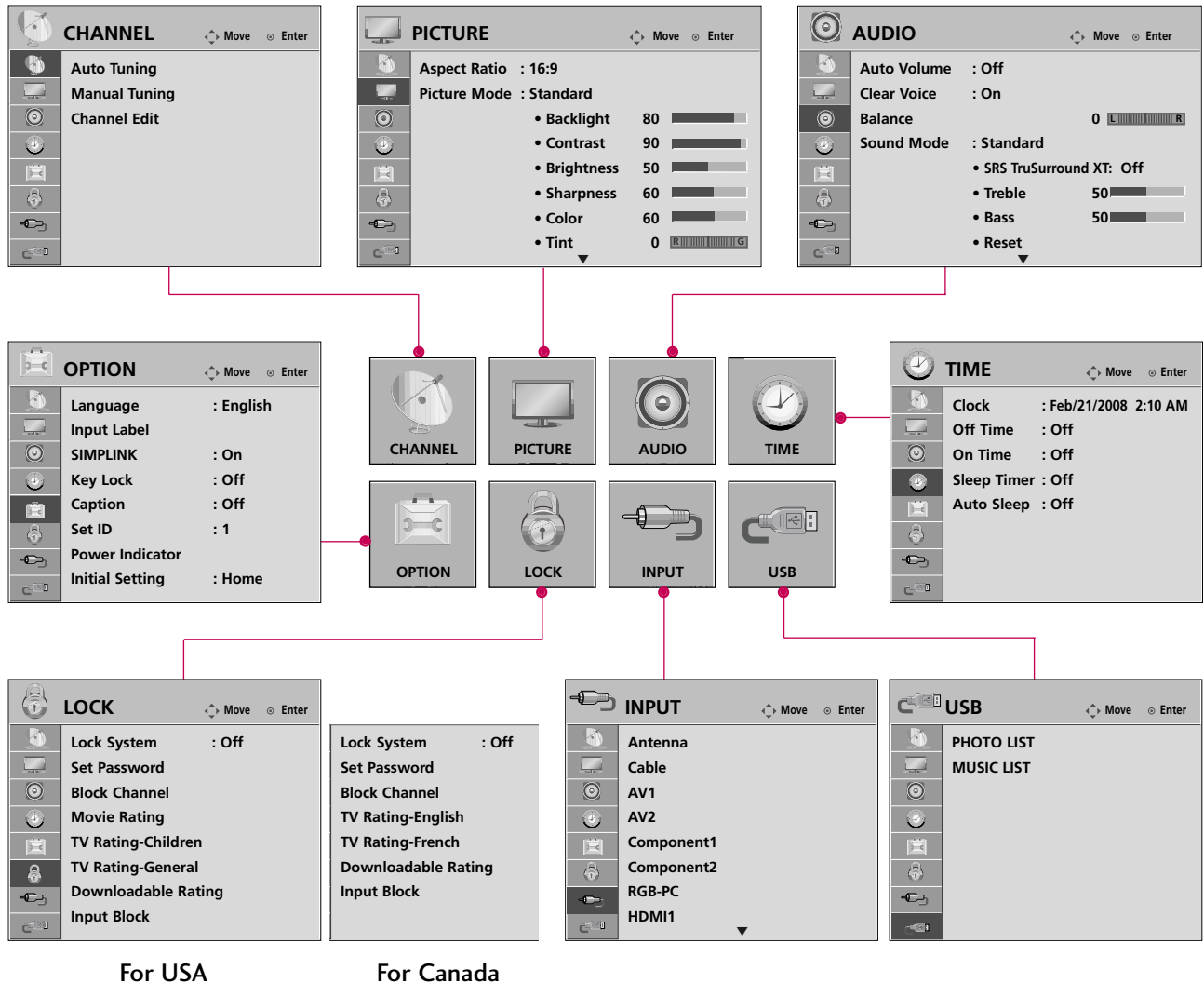

ON-SCREEN MENUS SELECTION

Your TV's OSD (On Screen Display) may differ slightly from that shown in this manual.

47/52LG50DC







WATCHING TV / CHANNEL CONTROL

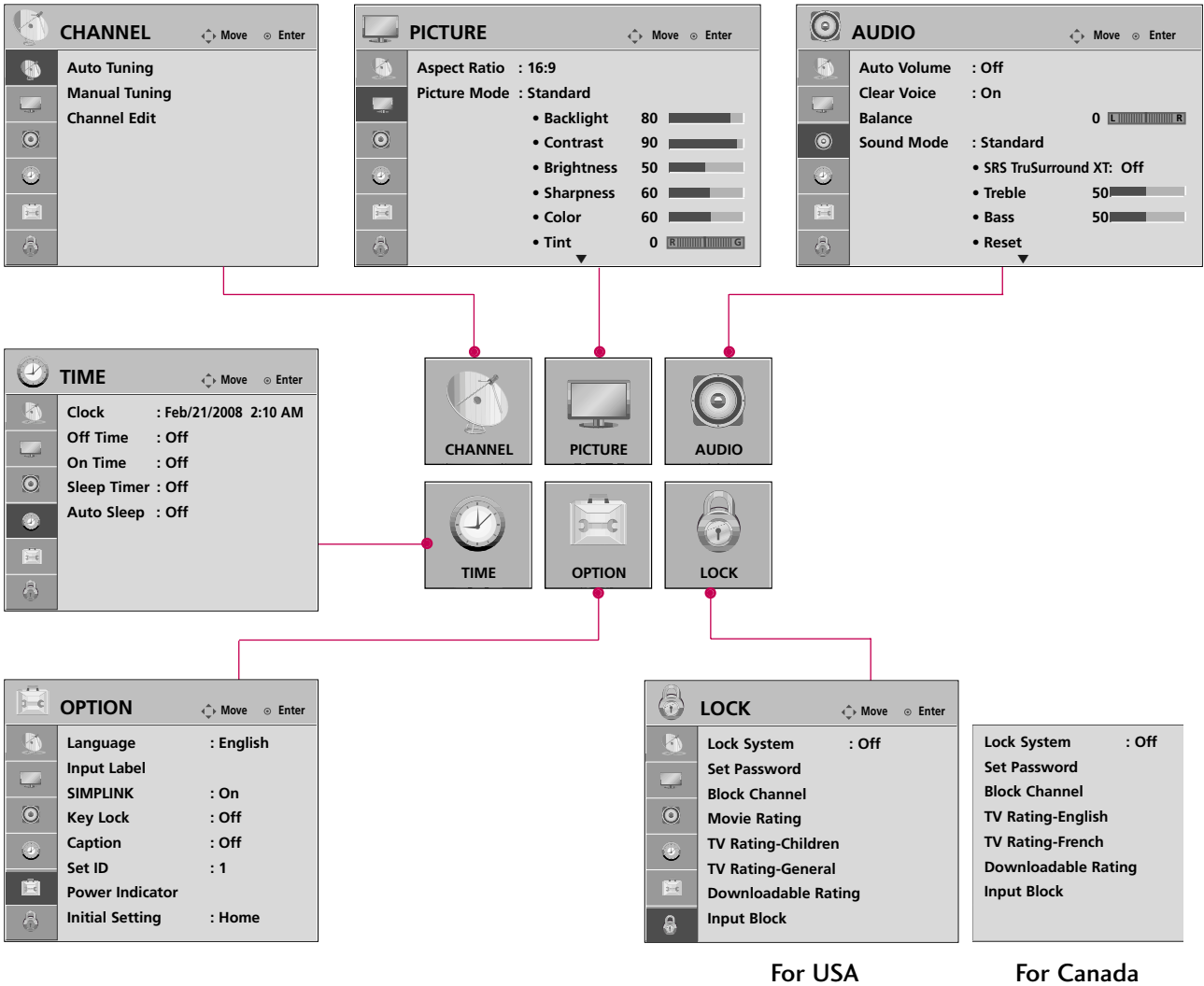

- 1   Display each menu.
- 2   Select a menu item.
- 3  Enter to the pop up menu.
- 4  Return to TV viewing.

32/37/42LG30DC



- 1   Display each menu.
- 2   Select a menu item.
- 3  Enter to the pop up menu.
- 4  Return to TV viewing.

WATCHING TV / CHANNEL CONTROL







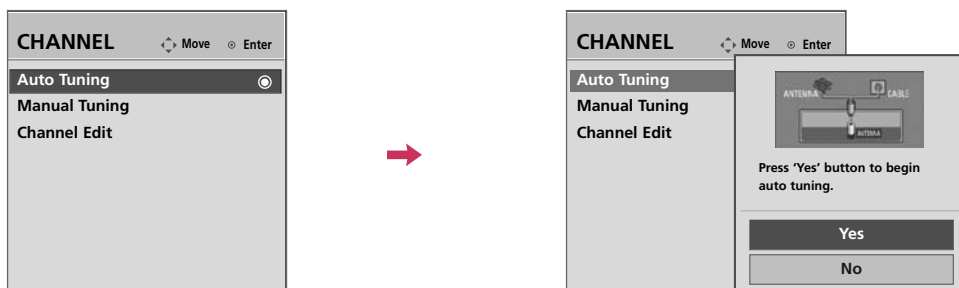

CHANNEL SETUP

Auto Scan (Auto Tuning)

Automatically finds all channels available through antenna or cable inputs, and stores them in memory on the channel list.

Run Auto Tuning again after any Antenna/Cable connection changes.











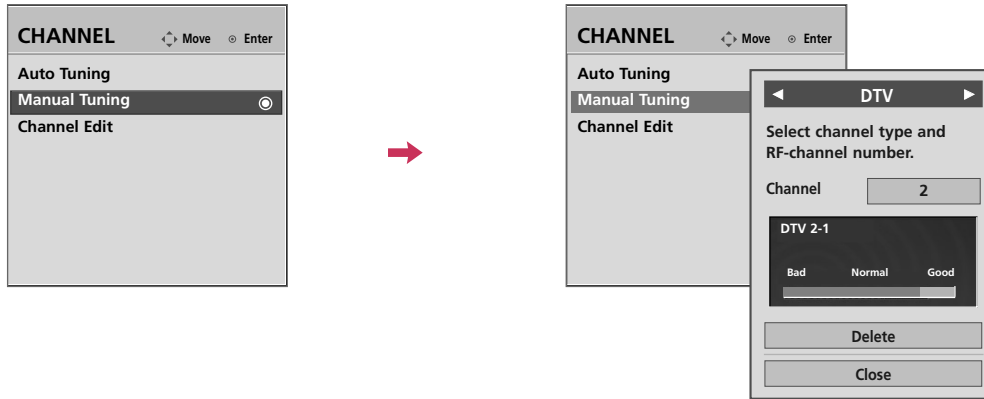

-   Select **CHANNEL**.
-   Select **Auto Tuning**.
-   Select **Yes**.
-  Run **Auto tuning**.
-  Return to the previous menu.
-  Return to TV viewing.

■ A password is required to gain access to Auto Tuning menu if the Lock System is turned on.

Add/Delete Channel (Manual Tuning)

If selecting DTV or CADTV input signal, you can view the on-screen signal strength monitor to see the quality of the signal being received.



- 1   Select **CHANNEL**.
- 2   Select **Manual Tuning**.
- 3   Select **DTV, TV, CADTV, or CATV**.
- 4   Select channel you want to add or delete.
- 5   Select **Add** or **Delete**.
- 6  Return to the previous menu.
-  Return to TV viewing.

■ A password is required to gain access to Manual Tuning menu if the Lock System is turned on.

WATCHING TV / CHANNEL CONTROL





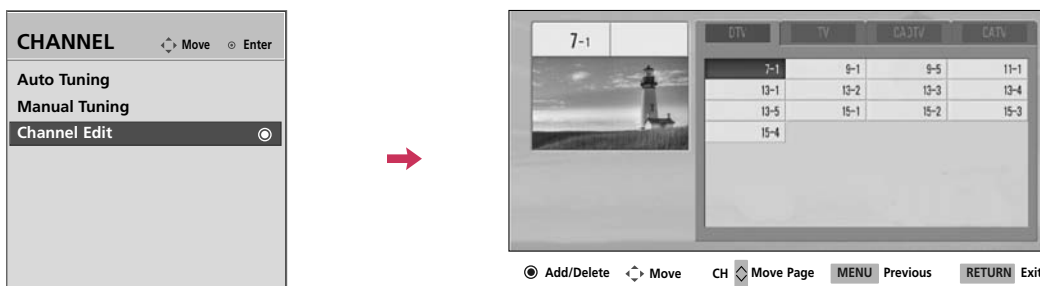

CHANNEL SETUP

Channel Editing

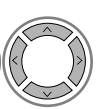
A custom list can be created by toggling each channel on or off with **ENTER** button. The channels in the Custom List are displayed in black and the channels deleted from the Custom List are displayed in gray.

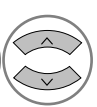
Once a channel is highlighted you can add or delete the channel by referring to the small window at the top-right corner of the screen.

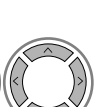

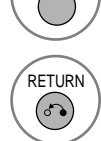
-   Select **CHANNEL**.
-   Select **Channel Edit**.
-   Select a channel.
-  Select channel you want to add or delete.
-  Return to the previous menu.
-  Return to TV viewing.

INPUT LIST

Only these input signals which are connected to a TV can be activated and selected.

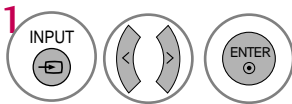

Select the desired input source.

- You can also select the desired input source in the **INPUT** menu (Except 32/37/42LG30DC).

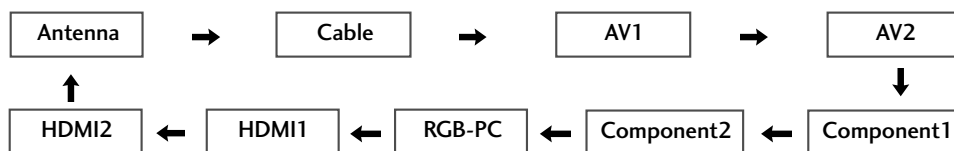

Disconnected inputs are inactive (grayed out)

Select a desired input source (except **Antenna** or **Cable**). Then, you can select your desired Input Label with using Q. MENU button. ► **p.46**

- **Antenna:** Select it to watch over-the-air broadcasts.
- **Cable:** Select it to watch cable and digital cable.
- **AV:** Select them to watch a VCR or other external equipment.
- **Component:** Select them to watch DVD or a Digital set-top box.
- **RGB-PC:** Select it to view PC input.
- **HDMI:** Select them to watch high definition devices.

WATCHING TV / CHANNEL CONTROL

INPUT LABEL

You can set a label for each input source when it's not in use.

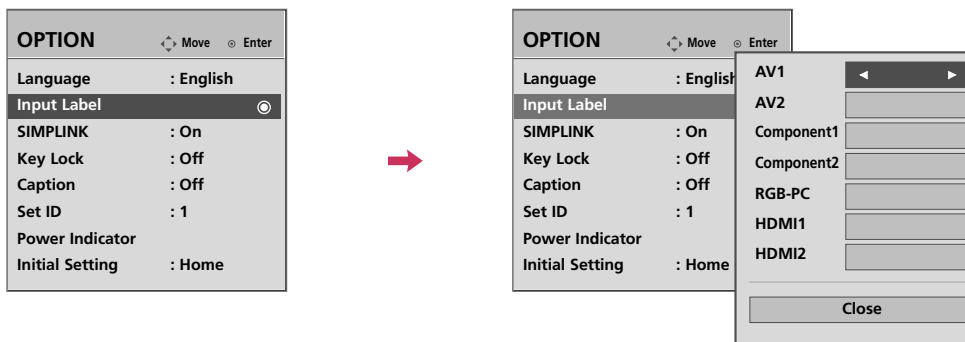

With using OPTION menu

- 1 Select **OPTION**.
- 2 Select **Input Label**.
- 3 Select the source.
- 4 Select the label.
- 5 Return to the previous menu.
- Return to TV viewing.

With using INPUT button

- 1 Select the source.
- 2 Select the label.
- 3 Return to the previous menu.
- Return to TV viewing.

Only for 47/52LG50DC

- When new external device is connected, this popup menu is displayed automatically. If selecting **Yes**, you can select input source that you want to appreciate.
- But, when selecting “**SIMPLINK - On**”, popup menu for HDMI input will not be displayed.

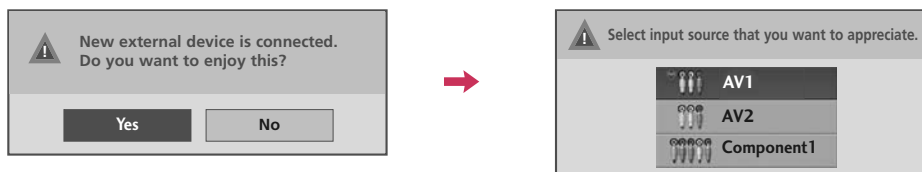

AV MODE

You can select the optimal images and sounds.

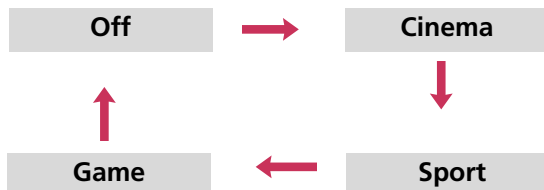

Press the **AV MODE** button repeatedly to select the desired source.



- If you select “**Cinema**” in AV mode, **Cinema** will be selected both for “**PICTURE** menu - Picture Mode” and “**AUDIO** menu - Sound Mode” respectively.
- If you select “**Off**” in AV mode, the “**Picture Mode**” and “**Sound Mode**” return to previous selected value.

WATCHING TV / CHANNEL CONTROL



This function operates only with devices with the logo.

The TV might not function properly when using it with other products with HDMI-CEC function.

This allows you to control and play other AV devices connected with HDMI cable without additional cables and settings.

To start using SIMPLINK, turn it on in the user menus.

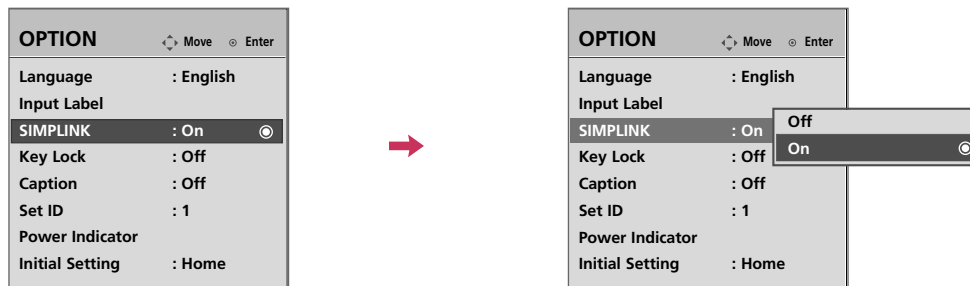

- Select **OPTION**.
- Select **SIMPLINK**.
- Select **On** or **Off**.
- Return to the previous menu.
- Return to TV viewing.

! NOTE

- ▶ Connect the HDMI/DVI IN or HDMI IN terminal of the TV to the rear terminal (HDMI terminal) of the SIMPLINK device with the HDMI cable.
- ▶ When you switch the Input source with the INPUT button on the remote control, the SIMPLINK device will stop.
- ▶ When you select a device with home theater functionality, the sound output automatically switches to the home theater speakers.
- ▶ If a connected SIMPLINK home theater system doesn't play the audio from the TV, connect the DIGITAL AUDIO OUT terminal on the back of the TV to the DIGITAL AUDIO IN terminal on the back of the SIMPLINK device with an OPTICAL cable.

SIMPLINK Functions

- **Direct Play:** After connecting AV devices to the TV, you can directly control the devices and play media without additional settings.
- **Select AV device:** Enables you to select one of the AV devices connected to TV.
- **Disc playback:** Control connected AV devices by pressing the \wedge \vee \lt \gt , ENTER, \blacktriangleright , \blacksquare , \parallel , \blacktriangleleft and \blacktriangleright buttons.
- **Power off all devices:** When you power off the TV, all connected devices are turned off.
- **Switch audio-out:** Offers an easy way to switch audio-out.
- **Sync Power on:** When you play the connected AV device, TV will automatically turn on.

(A device, which is connected to the TV through a HDMI cable but does not support SIMPLINK, does not provide this function)

Note: To operate SIMPLINK, an HDMI cable over Version 1.2 with *CEC function should be used. (*CEC: Consumer Electronics Control).

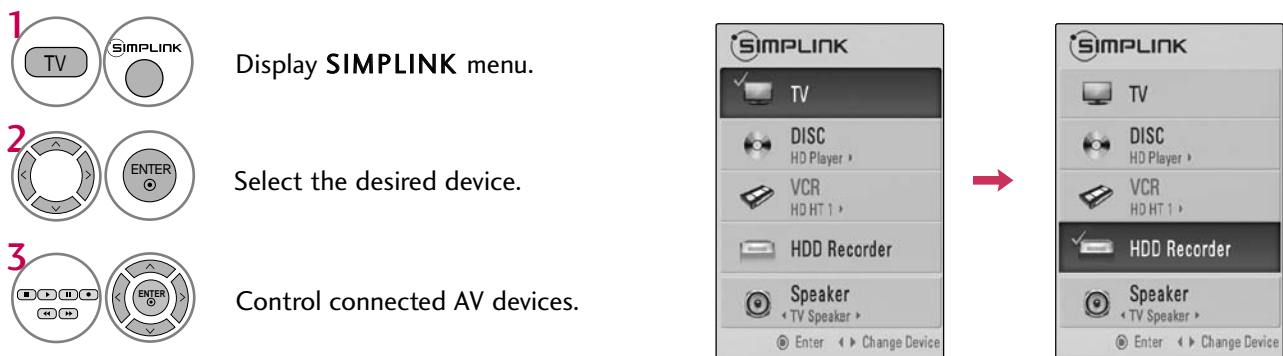

SIMPLINK Menu

- 1 TV viewing:** Switch to the previous TV channel regardless of the current mode.
- 2 DISC playback:** Select and play discs. When multiple discs are available, the titles of discs are conveniently displayed at the bottom of the screen.
- 3 VCR playback:** Control the connected VCR.
- 4 HDD Recordings playback:** Control recordings stored in HDD.
- 5 Audio Out to Home Theater speaker/Audio Out to TV:** Select Home Theater speaker or TV speaker for Audio Out.



- ▶ When no device is connected (displayed in gray)
- ▶ Selected Device
- ▶ When a device is connected (displayed in bright color)

USB

* Except 32/37/42LG30DC

ENTRY MODES

When you connect a USB device, this screen is displayed automatically.
In USB device, you can not add a new folder or delete the existing folder.

- 1 Connect the USB device to the **USB IN** jacks on the side of TV.

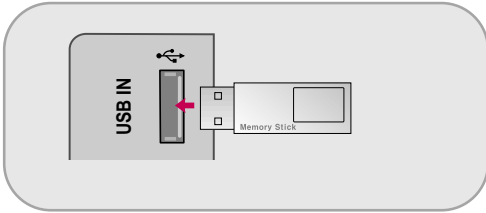

- It doesn't support USB HDD
- This TV supports JPG and MP3.

- 2 Select **PHOTO LIST** or **MUSIC LIST**

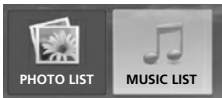
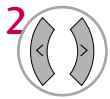

When removing the USB device

Select the **USB Eject** menu before removing the USB device.

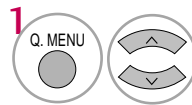

Select **USB Eject**.



Precautions when using the USB device

- ▶ Only a USB storage device is recognizable.
- ▶ If the USB storage device is connected through a USB hub, the device is not recognizable.
- ▶ A USB storage device using an automatic recognition program may not be recognized.
- ▶ A USB storage device which uses its own driver may not be recognized.
- ▶ In case of a card reader, up to four memory cards are concurrently recognizable.
- ▶ The recognition speed of a USB storage device may depend on each device.
- ▶ Please do not turn off the TV or unplug the USB device when the connected USB storage device is working. When such device is suddenly separated or unplugged, the stored files or the USB storage device may be damaged.
- ▶ Please do not connect the USB storage device which was artificially maneuvered on the PC. The device may cause the product to malfunction or fail to be played. Never forget to use only a USB storage device which has normal music files or image files.
- ▶ Please use only a USB storage device which was formatted as a FAT or NTFS file system provided with the Windows operating system. In case of a storage device formatted as a different utility program which is not supported by Windows, it may not be recognized.
- ▶ Please connect power to a USB storage device which requires an external power supply. If not, the device may not be recognized.
- ▶ Please connect a USB storage device with cable is offered by USB maker. If connected with cable is not offered by USB maker or an excessively long cable, the device may not be recognized.
- ▶ Some USB storage devices may not be supported or operated smoothly.
- ▶ File alignment method of USB storage device is similar to Window XP and filename can recognize up to 100 English characters.
- ▶ Please backup important files because data on USB device may be damaged. Data management is consumer's responsibility and as a result, the manufacturer does not cover data damage.



PHOTO LIST



You can view .JPG files from USB storage devices.
The On Screen Display on your model may be slightly different.

Supported photo file: *.JPG

- You can play JPG files only.
- Only baseline scan is supported among JPG.

Screen Components

1   Select **USB**.

2    Select **PHOTO LIST**.

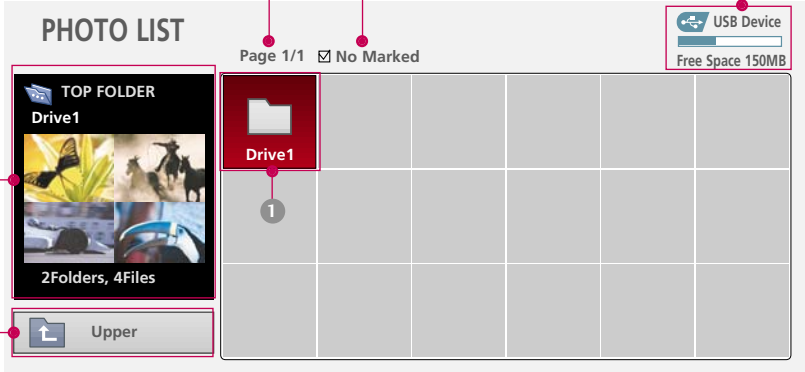

PHOTO LIST
Page 1/1 No Marked

USB Device
Free Space 150MB

TOP FOLDER
Drive1
2Folders, 4Files

Drive1

Upper

Navigate PopUp Menu CH Move Page FAV Mark RETURN Exit





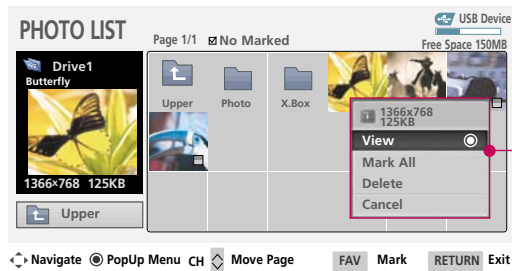
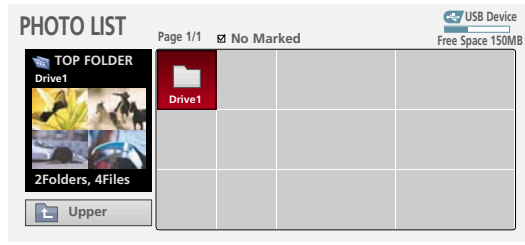

- ① Moves to upper level file
- ② Preview: Display the thumbnail/folder name of the photo in the selected folder
- ③ Current page/Total pages
- ④ Total number of marked photos
- ⑤ Usable USB memory
- ⑥ Corresponding buttons on the remote control

Photo Selection and PopUp Menu



When you select a file (not folder), this PopUp menu is displayed.

- ▶ **View:** Display the selected item.
- ▶ **Mark All:** Mark all photos on the screen.
- ▶ **Unmark All:** Deselect all marked photos.
- ▶ **Delete:** Delete the selected photo item.
- ▶ **Cancel:** Close the pop-up menu.

- 1  Select the target folder or drive.
- 2   Select the desired photos.
- 3  Show the PopUp menu.
- 4   Select the desired PopUp menu.





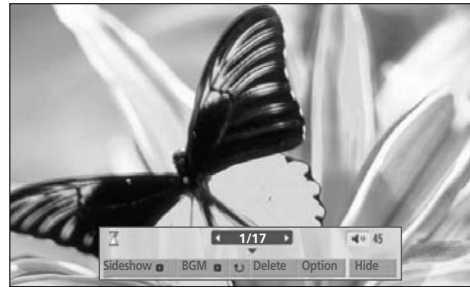
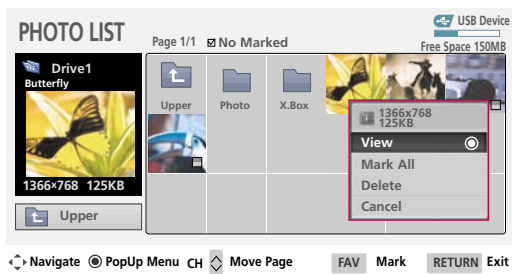
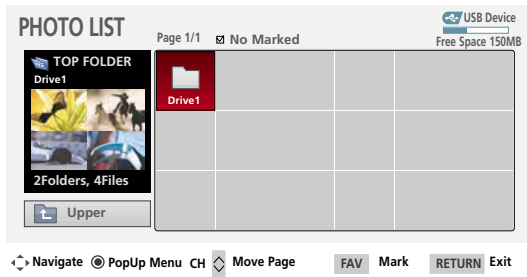

- Use the **CH** ^ v button to navigation in the photo page.
- Use the **FAV** button to mark or unmark a photo. When one or more photos are marked, you can view individual photos or a slide show of the marked photos. If no photos are marked, you can view all photos individually or all photos in the folder in a slide show.



Full Screen Menu

You can change the Photo List view so that it fills the screen. More operations are available in full screen mode.



The aspect ratio of a photo may change the size of the photo displayed on the screen in full size.

- 1  Select the target folder or drive.
- 2   Select the desired photos.
- 3  Show the PopUp menu.
- 4  Select **View**.
- 5  The selected photo is displayed in full size.

■ Use the **CH**   button to navigation in the photo page.

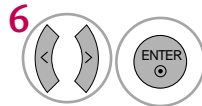

Select the **Sideshow**, **BGM**, **Rotate**, **Delete**, **Option**, or **Hide**.

- Use < > button to select the previous or next photo.
- Use ^ v < > button to select and control the menu on the full-sized screen.

- ▶ **Sideshow:** Selected photos are displayed during the slide show. If no photo is selected, all photos in the current folder are displayed during slide show.
 - Set the time interval of the slide show in **Option**.
 - A slide show continues for a maximum of 4 hours. After 4 hours, the slide show will end and go to TV mode or external input mode.
- ▶ **BGM:** Listen to music while viewing photos in full size.
 - Set the BGM device and album in **Option**.
- ▶ **Rotate:** Rotate photos.
 - Rotates the photo 90°, 180°, 270°, 360° clockwise.
- ▶ **Delete:** Delete photos.
- ▶ **Option:** Set values for **Slide Speed** and **Music Folder**.
 - Use < > button and **ENTER** button to set values. Then go to **Enter** and press **ENTER** to save the settings.
 - You cannot change **Music Folder** while BGM is playing.
- ▶ **Hide :** Hide the menu on the full-sized screen.
 - To see the menu again on the full-sized screen, press **ENTER** button to display.

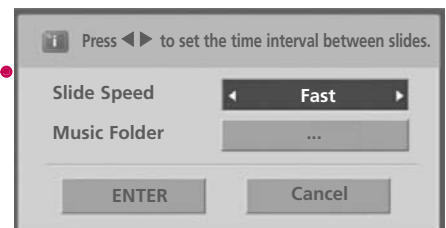

NOTE

- ▶ This TV will not be able to decode most JPEG images saved using the Progressive option.

MUSIC LIST

You can use the Music List menu to play MP3 files from a USB storage device.

This TV cannot play back copy-protected files.

The On Screen Display on your model may be slightly different.

Supported music file: *.MP3
 Bit rate range 40Kbps ~ 320Kbps

- Sampling rate (Sampling Frequency)
 - MPEG1 : 32000, 44100, 48000Hz
 - MPEG2 : 16000, 24000, 22050Hz
 - MPEG2.5 : 16 ~ 48KHz

Screen Components

1

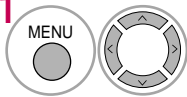

Select **USB**.

2

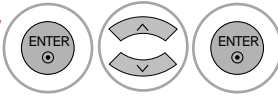

Select **MUSIC LIST**.

- ① Moves to upper level file
- ② Preview: If any album jacket for the file exists, this jacket is displayed.
- ③ Current page/Total pages
- ④ Total number of marked musics
- ⑤ Usable USB memory
- ⑥ Corresponding buttons on the remote control

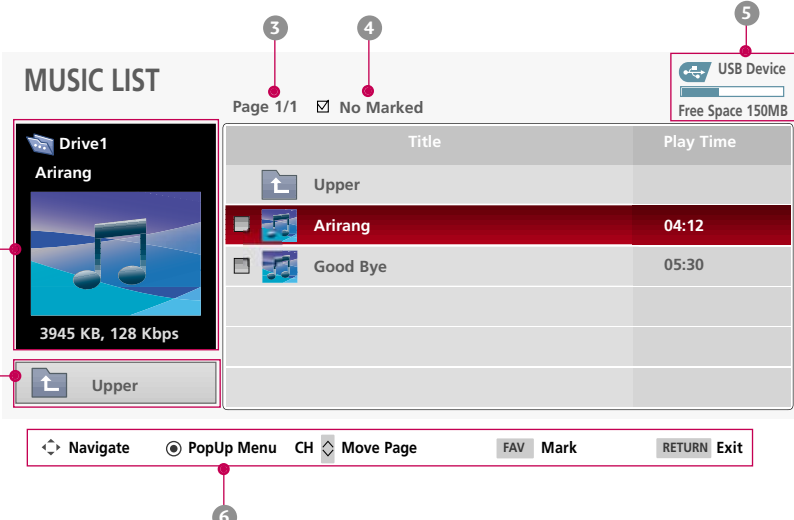





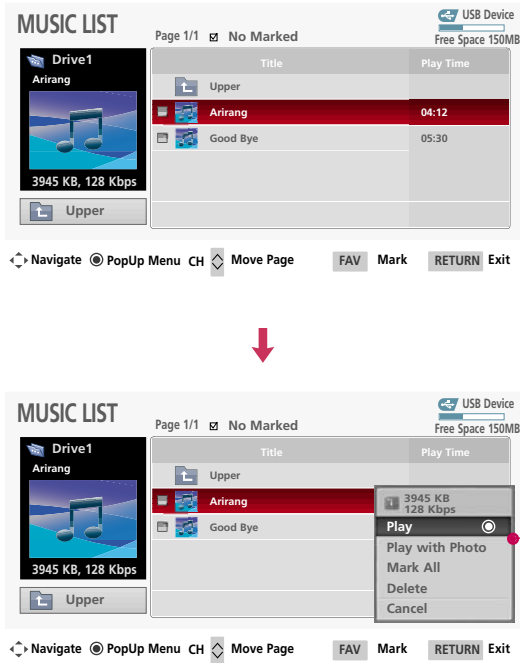

The screenshot shows the 'MUSIC LIST' interface. At the top, it displays 'Page 1/1' and 'No Marked'. On the right, a 'USB Device' status bar shows 'Free Space 150MB'. The main area is a table with columns 'Title' and 'Play Time'. The first row is 'Upper' (a folder), and the second row is 'Arirang' (a music file) with a play time of 04:12. A third row shows 'Good Bye' with a play time of 05:30. On the left side of the screen, there is a preview window for the selected file 'Arirang', showing an album jacket and file details: '3945 KB, 128 Kbps'. At the bottom, a navigation bar includes buttons for 'Navigate', 'PopUp Menu', 'CH', 'Move Page', 'FAV Mark', and 'RETURN Exit'.

Music Selection and Popup Menu

Up to 6 music titles are listed per page.



- ▶ **Play (During stop):** Play the selected music. Once a song finishes playing, the next selected one will be played. When there are no selected musics to play, the next one in the current folder will be played. If you go to a different folder and press the **ENTER** button, the current music in playback will stop.
- ▶ **Play Marked:** Play the selected musics. Once a music finishes playing, the next selected one will be played automatically.
- ▶ **Stop Play (During playback):** Stop the playing musics.
- ▶ **Play with Photo:** Start playing the selected musics and then move to the Photo List.
- ▶ **Mark All:** Mark all musics in the folder.
- ▶ **Unmark All:** Deselect all marked music.
- ▶ **Delete:** Delete the selected music.
- ▶ **Cancel:** Close the pop-up menu.

- 1  Select the target folder or drive.
- 2   Select the desired musics.
- 3  Show the Popup menu.
- 4   Select the desired Popup menu.
- 5  Return to TV viewing

- Use the **CH** ^ v button to navigation in the music page.
- Use **FAV** button to mark or unmark a music file. If no music is marked, all the music in the folder will be played in sequence. When one or more music files are marked, the marked music files will be played in sequence. If you want to listen to only one song repeatedly, just mark that one file and play.

- The play information box (as shown below) will automatically move across the screen when there is no user input to prevent a fixed image remaining on the screen for an extended period of time.



! NOTE

- ▶ When music is playing,  is displayed in front of the music play time.
- ▶ A damaged or corrupted music file that does not play displays 00:00 as the play time.
- ▶ Music files with copy-protection will not play.
- ▶ Press **ENTER**, **■**, or **RETURN** button to stop the screen saver.
- ▶ This TV can not play music files less than 16 Kbytes.

PICTURE CONTROL

PICTURE SIZE (ASPECT RATIO) CONTROL

This feature lets you choose the way an analog picture with a 4:3 aspect ratio is displayed on your TV.







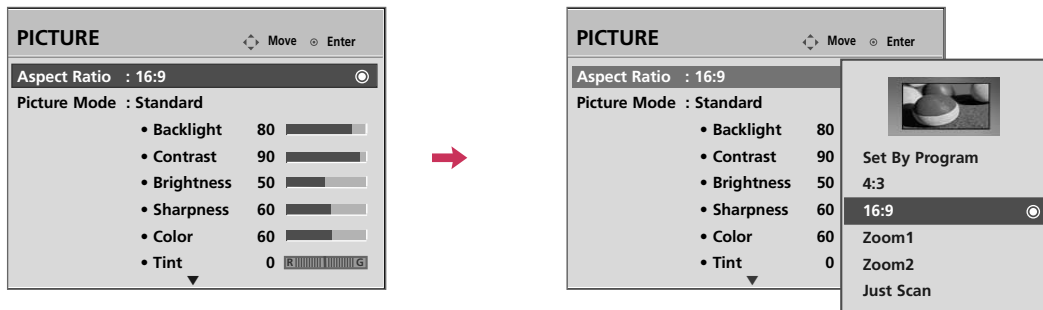

- RGB-PC input source use 4:3 or 16:9 aspect ratio.

! NOTE

- ▶ If a fixed image is displayed on the screen for a long time, the image could become imprinted on the screen and remain visible.

This phenomenon is common to all manufacturers and is not covered by warranty. Although, after watching video that did not fill the screen, any after-image from the black bars will normally dissipate after a few minutes.



-   Select **PICTURE**.
-   Select **Aspect Ratio**.
-   Select the desired picture format.
-  Return to the previous menu.
-  Return to TV viewing.

- You can also adjust **Aspect Ratio** in the **Q-Menu**.

Set by program

Selects the proper picture proportion to match the source's image.

(4:3 → 4:3)



(16:9 → 16:9)



4:3

Choose 4:3 when you want to view a picture with an original 4:3 aspect ratio.



16:9

Adjust the picture horizontally, in a linear proportion to fill the entire screen.



Zoom 1

Choose Zoom 1 when you want to view the picture without any alteration. However, the top and bottom portions of the picture will be cropped.



Zoom 2

Choose Zoom 2 when you want the picture to be altered, both vertically extended and cropped. The picture taking a halfway trade off between alteration and screen coverage.

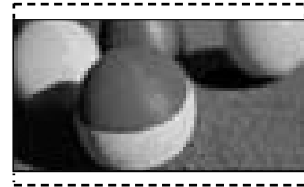

Just Scan

Normally the edges of video signals are cropped 1-2%. Just Scan turns off this cropping and shows the complete video.

Notes: If there is noise on the edges of the original signal, it will be visible when Just Scan is activated.

Just Scan operates only in DTV/CADTV/Component/HDMI-DTV/DVI-DTV (720p/1080i/1080p) input source.







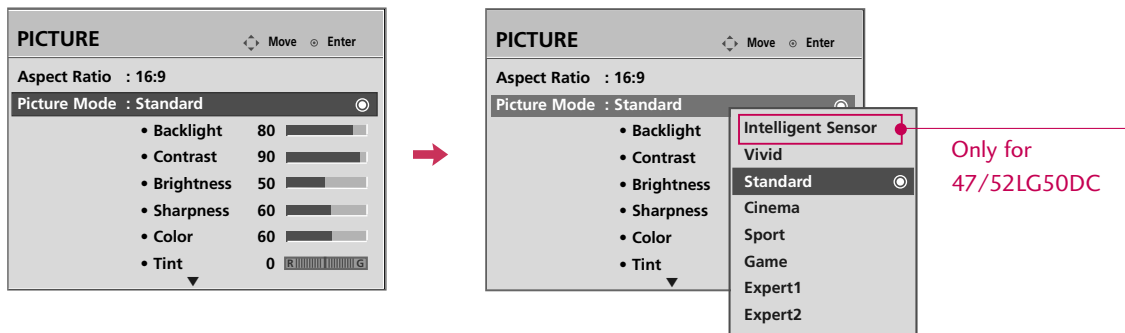

PICTURE CONTROL

PRESET PICTURE SETTINGS

Picture Mode - Preset

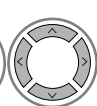
There are factory presets for picture settings available in the user menus. You can use a preset, change each setting manually, or use the Intelligent Sensor.

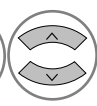
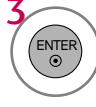
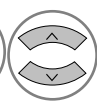









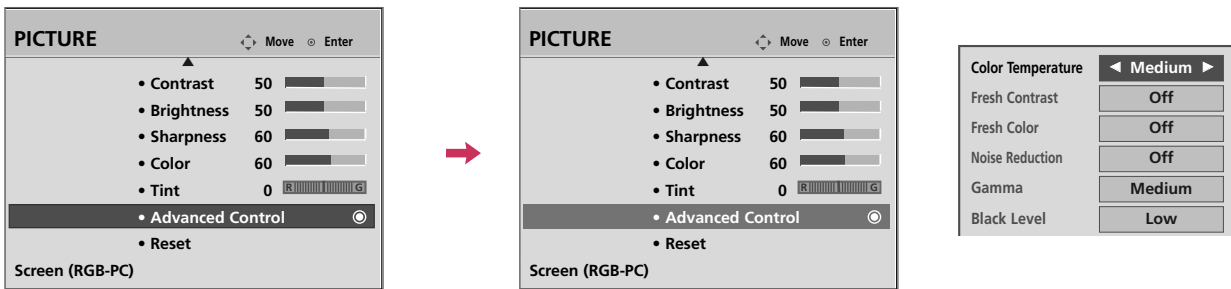

-   Select **PICTURE**.
-   Select **Picture Mode**.
-   Select **Intelligent Sensor** (Except 32/37/42LG30DC), **Vivid**, **Standard**, **Cinema**, **Sport**, or **Game**.
-  Return to the previous menu.
-  Return to TV viewing.

- When selecting **Intelligent Sensor** (Except 32/37/42LG30DC), the most suitable picture is automatically adjusted according to the surrounding conditions.
- **Vivid**, **Standard**, **Cinema**, **Sport**, and **Game** Settings are preset for the optimum picture quality at the factory and are not adjustable.
- You can also adjust **Picture Mode** in the **Q. Menu**. ratio changes to Just scan.

Color Tone - Preset

Choose one of three automatic color adjustments. Set to warm to enhance hotter colors such as red, or set to cool to see less intense colors with more blue.



- 1   Select **PICTURE**.
- 2   Select **Advanced Control**.
- 3   Select **Color Temperature**.
- 4   Select **Cool, Medium, or Warm**.
- 5  Return to the previous menu.
-  Return to TV viewing.









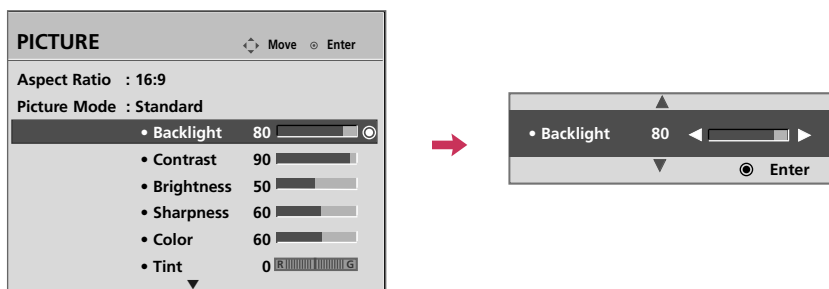

PICTURE CONTROL

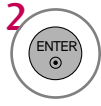
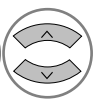
MANUAL PICTURE ADJUSTMENT

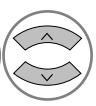
Picture Mode - User Mode

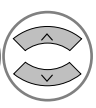
Adjust the picture appearance to suit your preference and viewing situations. This feature is disabled in “Picture Mode-Intelligent Sensor”.

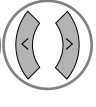







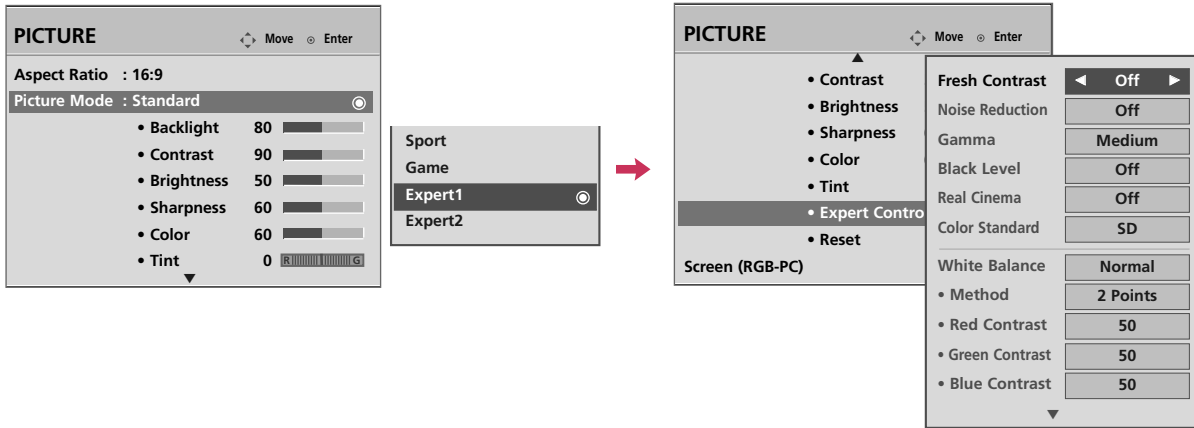







-   Select **PICTURE**.
-   Select **Picture Mode**.
-   Select **Vivid, Standard, Cinema, Sport, or Game**.
-   Select **Backlight, Contrast, Brightness, Sharpness, Color, or Tint**.
-   Make appropriate adjustments.
-  Return to the previous menu.
-  Return to TV viewing.

Picture Mode - Expert Control

By segmenting categories, **Expert1** and **Expert2** provide more categories which users can set as they see fit, offering the optimal picture quality for users.



- 1   Select **PICTURE**.
- 2   Select **Picture Mode**.
- 3   Select **Expert1** or **Expert2**.
- 4   Select **Expert Control**.
- 5   Select your desired menu option.
- 6   Make appropriate adjustments.
- 7  Return to the previous menu.
-  Return to TV viewing.

PICTURE CONTROL

PICTURE IMPROVEMENT TECHNOLOGY





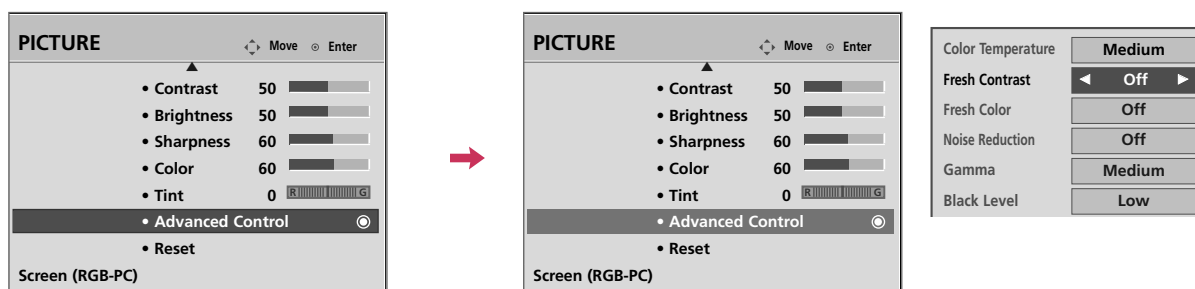

Fresh Contrast: Optimizes the contrast automatically according to the brightness of the reflection.

Fresh Color: Adjusts the color of the reflection automatically to reproduce as close as possible natural colors.

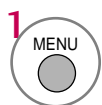
Noise Reduction: Removes interference up to the point where it does not damage the original picture.

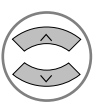
Gamma: High gamma values display whitish images and low gamma values display high contrast images.

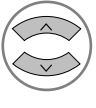
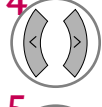







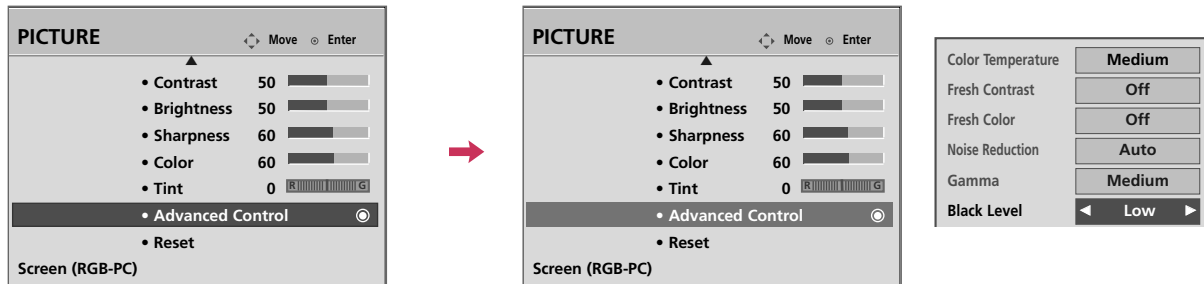



-   Select **PICTURE**.
-   Select **Advanced Control**.
-   Select **Fresh Contrast, Fresh Color, Noise Reduction, or Gamma**.
-  Select your desired options.
-  Return to the previous menu.
-  Return to TV viewing.

ADVANCED CONTROL - BLACK (DARKNESS) LEVEL

Adjusting the contrast and the brightness of the screen using the black level of the screen. This feature is disabled in DTV and RGB-PC mode.



- 1   Select **PICTURE**.
- 2   Select **Advanced Control**.
- 3   Select **Black Level**.
- 4   Select **Low** or **High**.
- 5  Return to the previous menu.
-  Return to TV viewing.

- **Low:** The reflection of the screen gets darker.
- **High:** The reflection of the screen gets brighter.
- **Auto:** Realizing the black level of the screen and set it to High or Low automatically.







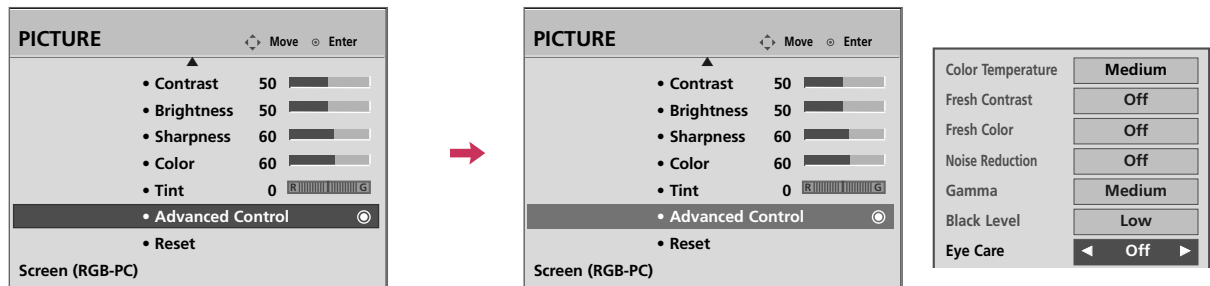

PICTURE CONTROL

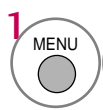
ADVANCED CONTROL - EYE CARE

Dims extremely bright pictures.

This feature is disabled in “Picture Mode-Vivid, Cinema”.

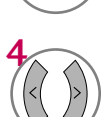

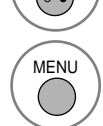
-   Select **PICTURE**.
-   Select **Advanced Control**.
-   Select **Eye Care**.
-  Select **On** or **Off**.
-  Return to the previous menu.
-  Return to TV viewing.

ADVANCED CONTROL - REAL CINEMA

Set up the TV for the best picture appearance for viewing movies.

When you operate Real Cinema (3:2 Pull-Down Mode or Cinema Correction Mode), the TV will adjust 24 fps video from movies to 30 fps video for display.

This feature operates only in TV (Analog TV/CATV, Digital DTV/CADTV), AV1, AV2, Component 480i/1080i, and HDMI 1080i mode.

47/52LG50DC only: This TV outputs 48Hz in DTV, Component, and HDMI 1080p (24Hz).

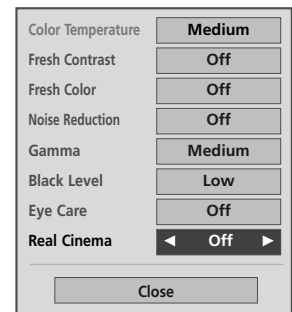
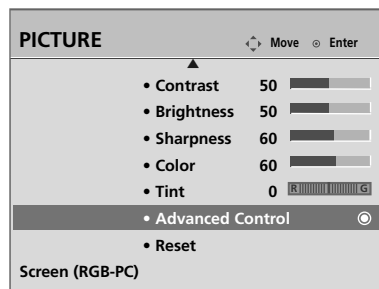
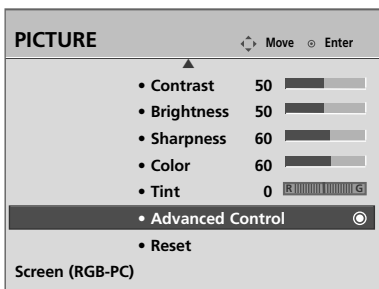

- 1 Select **PICTURE**.
- 2 Select **Advanced Control**.
- 3 Select **Real Cinema**.





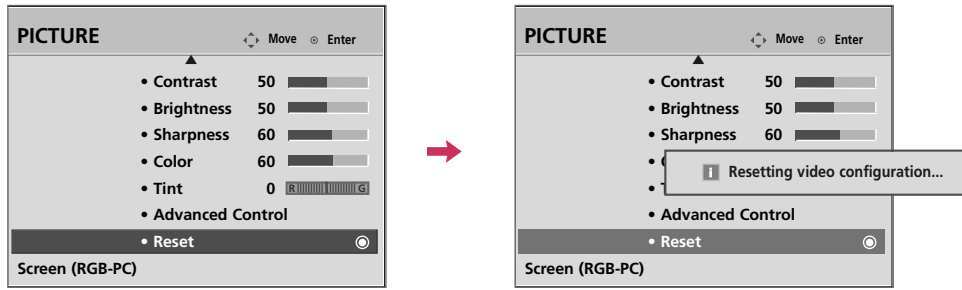

- 4 Select **On** or **Off**.
- 5 Return to the previous menu.
- Return to TV viewing.

PICTURE CONTROL

PICTURE RESET







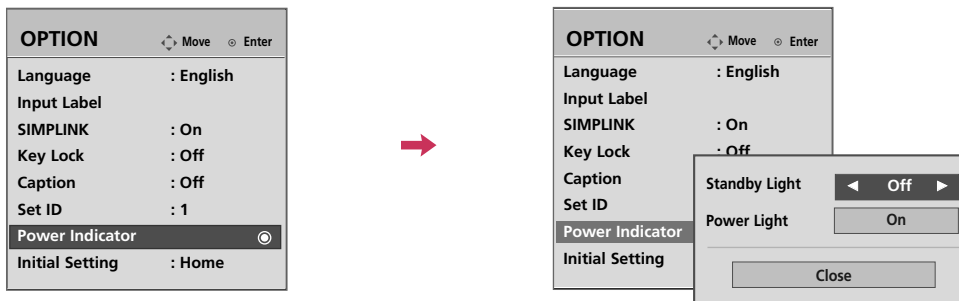

Settings of the selected picture modes return to the default factory settings.



-   Select **PICTURE**.
-   Select **Reset**.
-  Initialize the adjusted value.
-  Return to TV viewing.

POWER INDICATOR



- 1   Select **OPTION**.
- 2   Select **Power Indicator**.
- 3   Select **Standby Light** or **Power Light**.
- 4  Select your desired options.
- 5  Return to the previous menu.
-  Return to TV viewing.







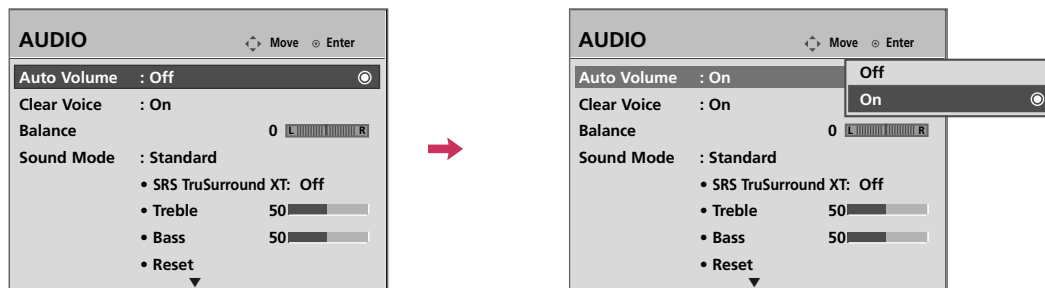

- **Standby Light:** You can set the brightness of the LED on the front side of the TV during power standby.
- **Power Light:** You can set the the LED on the front side of the TV to be turned on or off while watching the TV.

SOUND & LANGUAGE CONTROL

AUTO VOLUME LEVELER (AUTO VOLUME)

Auto Volume makes sure that the volume level remains consistent whether you are watching a commercial or a regular TV program.









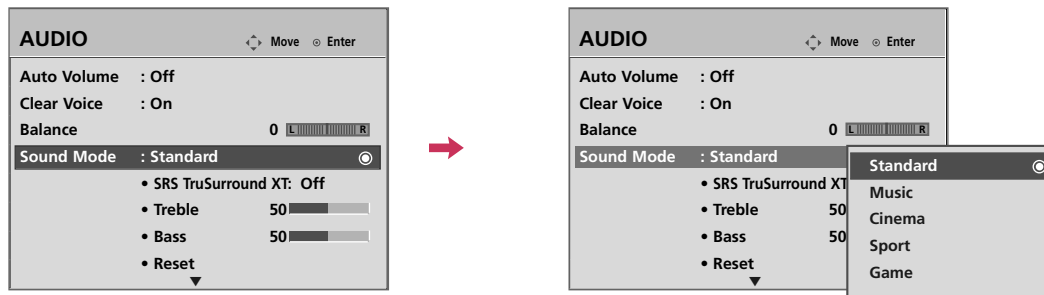

-   Select **AUDIO**.
-   Select **Auto Volume**.
-   Select **On** or **Off**.
-  Return to the previous menu.
-  Return to TV viewing.

PRESET SOUND SETTINGS (SOUND MODE)

Sound Mode lets you enjoy the best sound without any special adjustment as the TV sets the appropriate sound options based on the program content.

Standard, Music, Cinema, Sport, and Game are preset for optimum sound quality at the factory and are not adjustable.



-   Select **AUDIO**.
-   Select **Sound Mode**.
-   Select **Standard, Music, Cinema, Sport, or Game**.
-  Return to the previous menu.
-  Return to TV viewing.







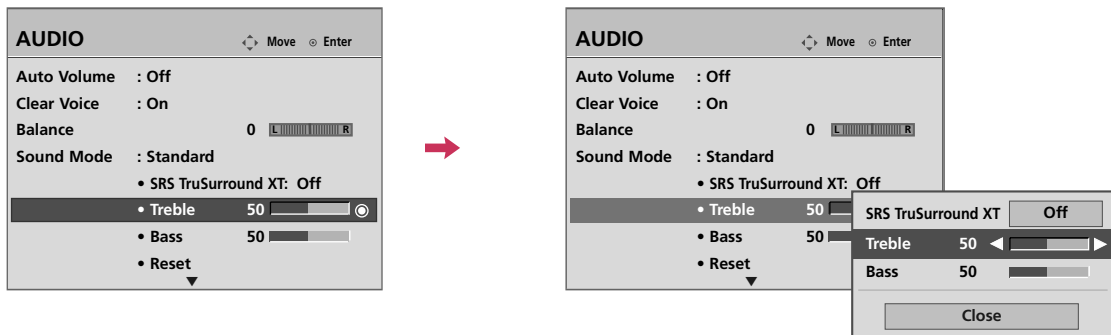

■ You can also adjust **Sound Mode** in the **Q. Menu**.

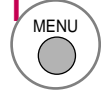

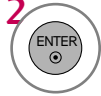

SOUND & LANGUAGE CONTROL

SOUND SETTING ADJUSTMENT - USER MODE







Adjust the sound to suit your taste and room situations.

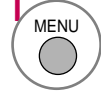

-   Select **AUDIO**.
-   Select **Sound Mode**.
-   Select **Standard, Music, Cinema, Sport, or Game**.
-   Select **Treble or Bass**.

-   Make appropriate adjustments.
-  Return to the previous menu.
-  Return to TV viewing.

SRS TRUSURROUND XT

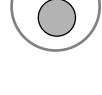





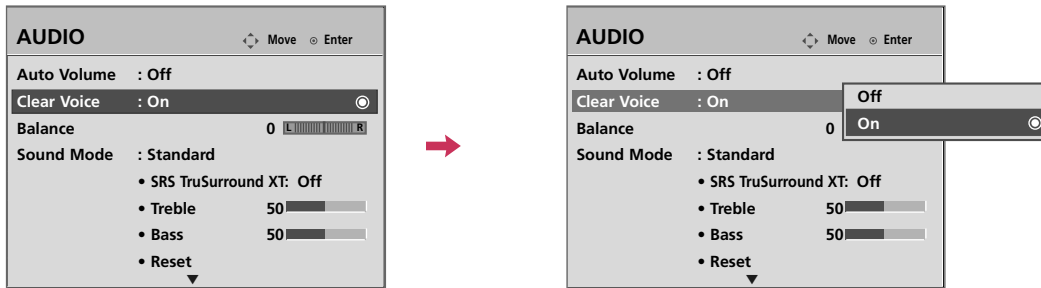

-   Select **AUDIO**.
-   Select **SRS TruSurround XT**
-   Select **On or Off**.
-  Return to the previous menu.
-  Return to TV viewing.

■ **SRS TruSurround XT:** Takes advantage of any multi-channel format without needing to add extra speakers or equipment. Dialog clarity, bass enrichment, and the addition of stereo audio enhancement produces an immersive sound experience from standard stereo material.

CLEAR VOICE

By differentiating the human sound range from others, it improves the sound quality of voices.



- 1   Select **AUDIO**.
- 2   Select **Clear Voice**.
- 3   Select **On** or **Off**.
- 4  Return to the previous menu.
-  Return to TV viewing.







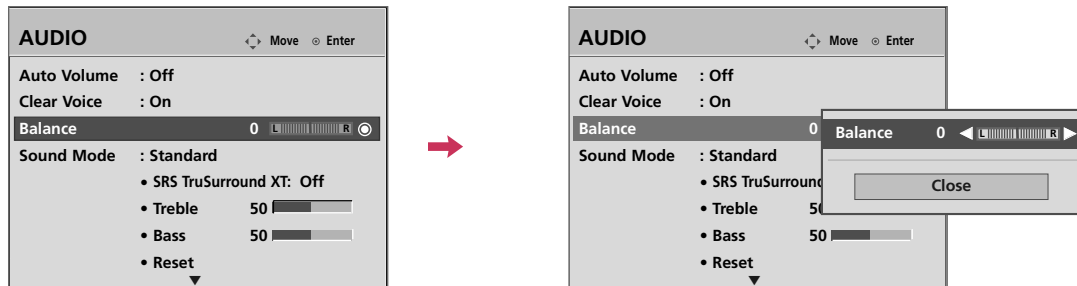

- If you select “Clear Voice-On”, SRS TruSurround XT feature will not work.
- You can also adjust Clear Voice in the Q-Menu.

SOUND & LANGUAGE CONTROL

BALANCE

Adjust the left/right sound of speaker to suit your taste and room situations.









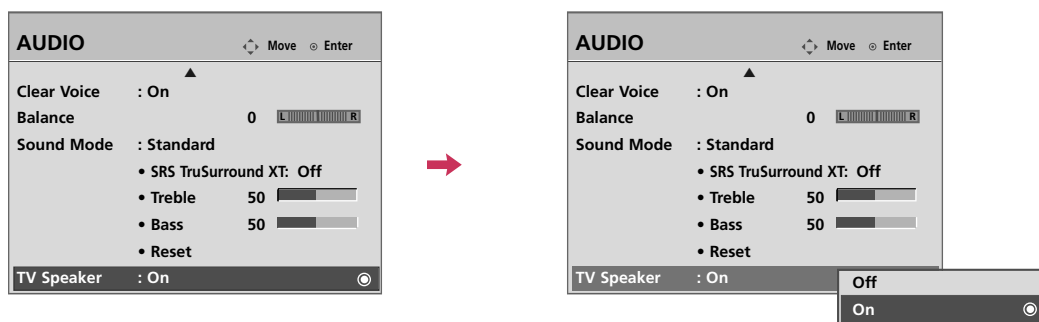

-   Select **AUDIO**.
-   Select **Balance**.
-   Make appropriate adjustments.
-  Return to the previous menu.
-  Return to TV viewing.

TV SPEAKERS ON/OFF SETUP

Turn the TV speakers off if using external audio equipment.







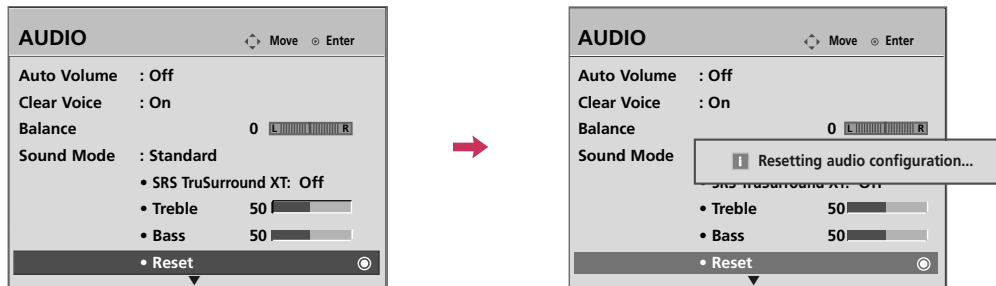

- 1   Select **AUDIO**.
- 2   Select **TV Speaker**.
- 3   Select **On** or **Off**.
- 4  Return to the previous menu.
-  Return to TV viewing.

SOUND & LANGUAGE CONTROL

AUDIO RESET

Settings of the selected Sound Mode return to the default factory settings.



-   Select **AUDIO**.
-   Select **Reset**.
-  Initialize the adjusted value.
-  Return to TV viewing.

STEREO/SAP BROADCAST SETUP

For Analog only: This TV can receive MTS stereo programs and any SAP (Secondary Audio Program) that accompanies the stereo program if the station transmits an additional sound signal. Mono sound is automatically used if the broadcast is only in Mono.



Analog TV

1   Select **SAP**.

2  Select **Mono, Stereo, or SAP**.

3  Return to TV viewing.

Digital TV

1   Select **Multi Audio**.

2  Select other languages.

3  Return to TV viewing.

SOUND & LANGUAGE CONTROL

AUDIO LANGUAGE

Other languages may be available if a digital signal is provided by the broadcasting station.
This feature operates only in DTV/CADTV mode.

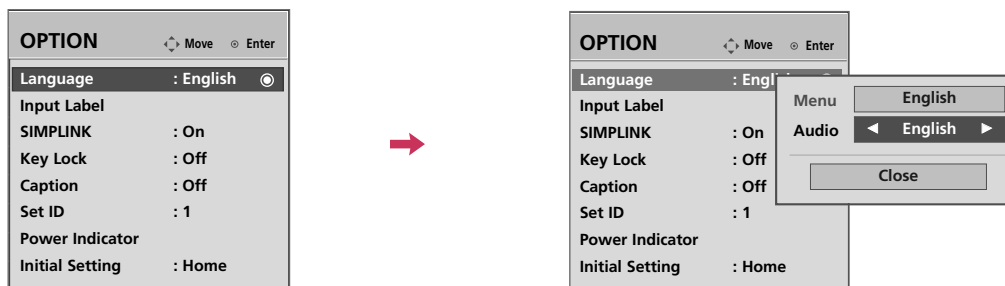







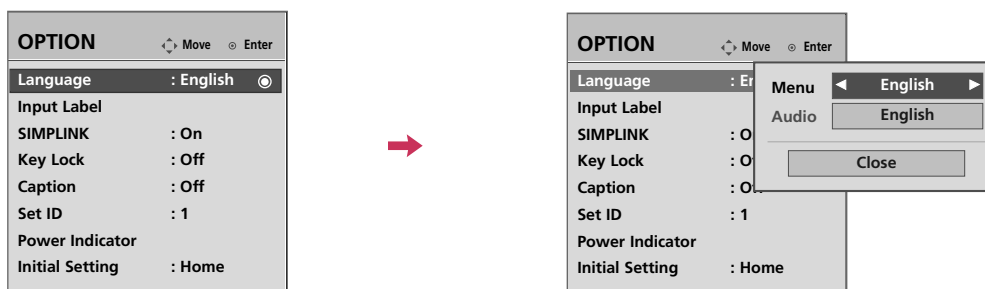

-   Select **OPTION**.
-   Select **Language**.
-   Select **Audio**.
-  Select your desired language:
English, Spanish, or French
-  Return to the previous menu.
-  Return to TV viewing.

ON-SCREEN MENUS LANGUAGE SELECTION

The menus can be shown on the screen in the selected language.



-   Select **OPTION**.
-   Select **Language**.
-   Select **Menu**.
-  Select your desired language.
From this point on, the on-screen menu will be shown in the selected language.
-  Return to the previous menu.
-  Return to TV viewing.







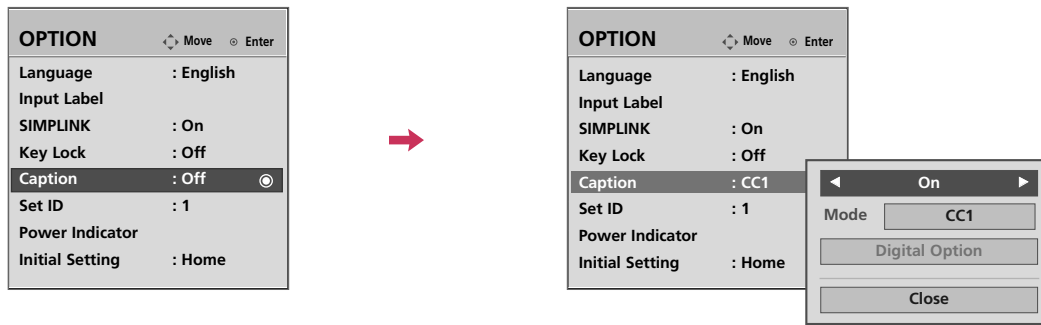

SOUND & LANGUAGE CONTROL

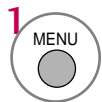
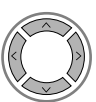
CAPTION MODE

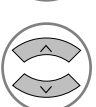
Analog Broadcasting System Captions

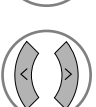
Caption must be provided to help people with hearing loss watch TV. Select a caption mode for displaying captioning information if provided on a program. Analog caption displays information at any position on the screen and is usually the program's dialog. Caption/Text, if provided by the broadcaster, would be available for both digital and analog channels on the Antenna/Cable. This TV is programmed to memorize the caption/text mode which was last set when you turned the power off. This function is only available when **Caption Mode** is set **On**.

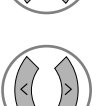

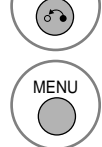
-   Select **OPTION**.
-   Select **Caption**.
-   Select **On**.
-   Select **CC1-4** or **Text1-4**.
-  Return to the previous menu.
-  Return to TV viewing.

- When selecting **Off**, Sub-menus for Analog, DTV, and Digital Option become disabled.
- **CAPTION**
The term for the words that scroll across the bottom of the TV screen; usually the audio portion of the program provided for the hearing impaired.
- **TEXT**
The term for the words that appear in a large black frame and almost cover the entire screen; usually messages provided by the broadcaster.









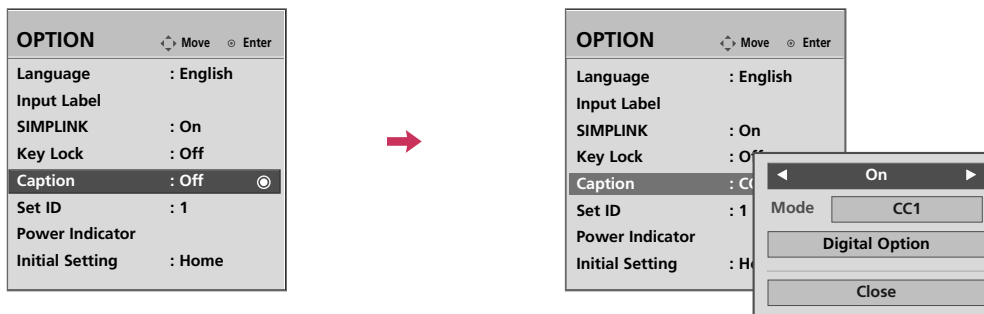

Digital Broadcasting System Captions

Choose the language you want the DTV/CADTV Captions to appear in.

Other Languages can be chosen for digital sources only if they are included on the program.

This function is only available when Caption Mode is set On.











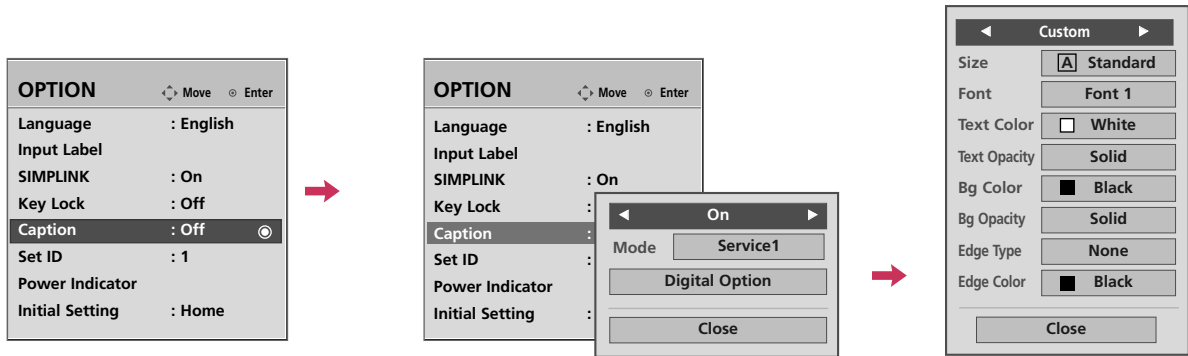





- 1   Select **OPTION**.
- 2   Select **Caption**.
- 3   Select **On**.
- 4   Select **CC1-4, Text1-4, or Service1 - 6**.
- 5  Return to the previous menu.
-  Return to TV viewing.

SOUND & LANGUAGE CONTROL

Caption Option

Customize the DTV/CADTV captions that appear on your screen.
This function is only available when **Caption Mode** is set **On**.



- 1   Select **OPTION**.
- 2   Select **Caption**.
- 3   Select **On**.
- 4   Select **Digital Option**.
- 5   Select **Custom**.
- 6   Customize the **Style, Font**, etc., to your preference. A preview icon is provided at the bottom of the screen, use it to see the caption language.
- 7  Return to the previous menu.
-  Return to TV viewing.

- **Size:** Set the word size.
- **Font:** Select a typeface for the text.
- **Text Color:** Choose a color for the text.
- **Text Opacity:** Specify the opacity for the text color.
- **Bg (Background) Color:** Select a background color.
- **Bg (Background) Opacity:** Select the opacity for the background color.
- **Edge Type:** Select an edge type.
- **Edge Color:** Select a color for the edges.

TIME SETTING

CLOCK SETTING









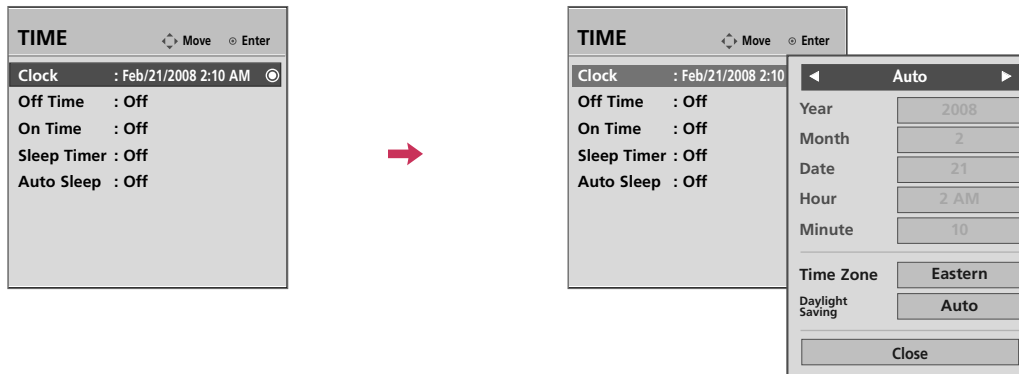



Auto Clock Setup

The time is set automatically from a digital channel signal.

The digital channel signal includes information for the current time provided by the broadcasting station.

Set the clock manually if the current time is set incorrectly by the auto clock function.







-   Select **TIME**.
-   Select **Clock**.
-   Select **Auto**.
-   Select your viewing area time zone.
 - U.S.A: **Eastern, Central, Mountain, Pacific, Alaska, or Hawaii.**
 - Canada: **Eastern, Central, Mountain, Pacific, New F.land, or Atlantic.**
-   Select **Auto, Off, or On** (depending on whether or not your viewing area observes Daylight Saving time).
-  Return to the previous menu.
-  Return to TV viewing.

TIME SETTING

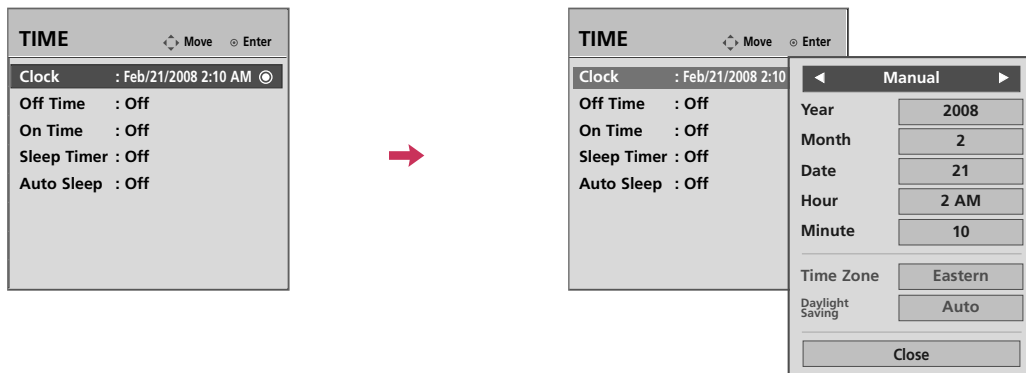
Manual Clock Setup

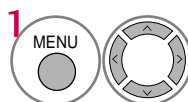
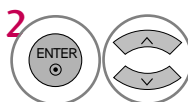
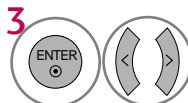
If the current time setting is wrong, set the clock manually.

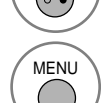

-  Select **TIME**.
-  Select **Clock**.
-  Select **Manual**.
-  Select the Year, Month, Date, Hour, or Minutes option.
-  Set the Year, Month, Date, Hour, or Minutes option.
-  Return to the previous menu.
-  Return to TV viewing.

AUTO ON/OFF TIME SETTING

This function operates only if the current time has been set.

The **Off Time** function overrides the **On Time** function if they are both set to the same time.

The TV must be in standby mode for the **On Time** to work.

If you do not press any button within 2 hours after the TV turns on with the **On Time** function, the TV will automatically revert to standby mode.

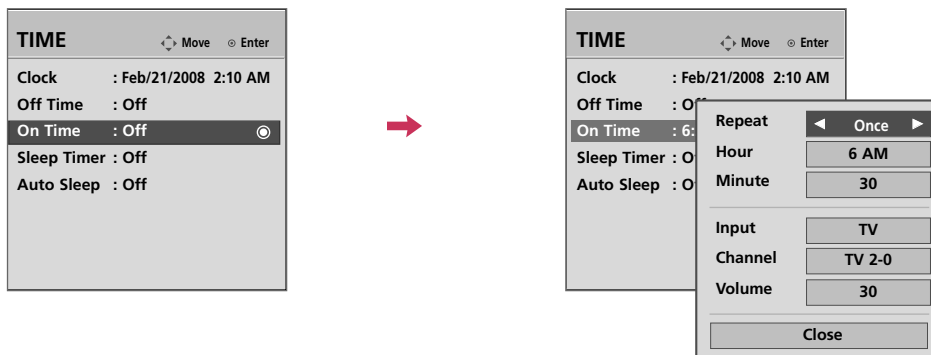

- 1 Select **TIME**.
- 2 Select **Off time** or **On time**.
- 3 Select **Repeat**.
- 4 Select **Off, Once, Everyday, Mon~Fri, Mon~Sat, Weekend, or Sunday**.
- 5 Select and set **Hour** or **Minute**.
- 6 Return to the previous menu.
- Return to TV viewing.





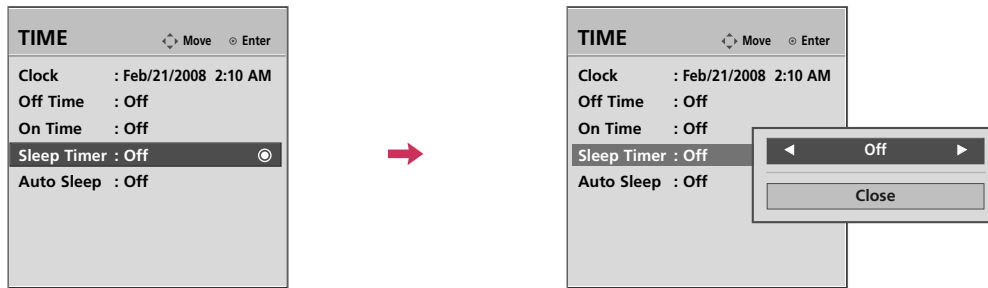

- To cancel **On/Off Time** function, select **Off**.
 - Only for **On Time** function
- 1 Select **Input**.
 - 2 Select the desired input source.
 - 3 When Selecting **TV**: set the channel at turn-on.
 - 4 Adjust to sound level at turn-on.

TIME SETTING

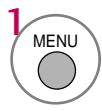
SLEEP TIMER SETTING

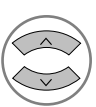
The Sleep Timer turns the TV off at the preset time.
Note that this setting is cleared when the TV is turned off.

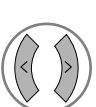

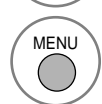





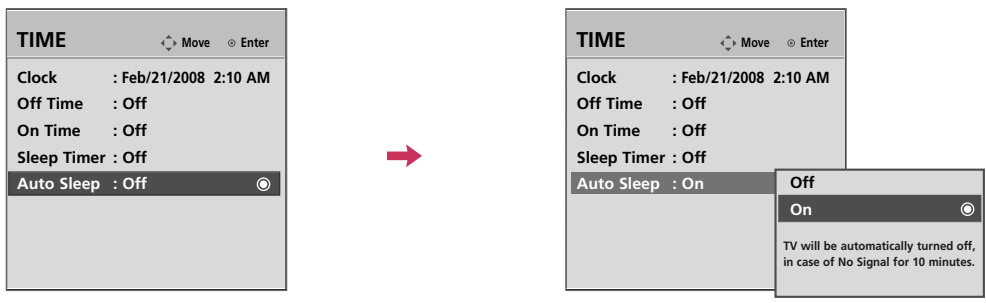

-   Select **TIME**.
-   Select **Sleep Timer**.
-   Select **Off, 10, 20, 30, 60, 90, 120, 180, or 240 minutes**.
-  Return to the previous menu.
-  Return to TV viewing.

■ You can also adjust **Sleep Timer** in the **Q-Menu**.

AUTO SHUT-OFF SETTING

TV will be automatically turned off, in case of no signal for 10 minutes.



-   Select **TIME**.
-   Select **Auto Sleep**.
-   Select **On** or **Off**.
-  Return to the previous menu.
-  Return to TV viewing.

PARENTAL CONTROL / RATINGS

Parental Control can be used to block specific channels, ratings and other viewing sources.

The Parental Control Function (V-Chip) is used to block program viewing based on the ratings sent by the broadcasting station. The default setting is to allow all programs to be viewed. Viewing can be blocked by choosing the type of the program and the categories. It is also possible to block all program viewing for a time period. To use this function, the following must be done :

1. Set ratings and categories to be blocked.
2. Specify a password
3. Enable the lock

V-Chip rating and categories

Rating guidelines are provided by broadcasting stations. Most television programs and television movies can be blocked by TV Rating and/or Individual Categories. Movies that have been shown at the theaters or direct-to-video movies use the Movie Rating System (MPAA) only.

Ratings for Television programs including made-for-TV movies :

- TV-G (General audience)
- TV-PG (Parental guidance suggested)
- TV-14 (Parents strongly cautioned)
- TV-MA (Mature audience only)
- TV-Y (All children)
- TV-Y7 (Children 7 years older)

SET PASSWORD & LOCK SYSTEM

Setting up Your Password

Set up blocking schemes to block specific channels, ratings, and external viewing sources. A password is required to gain access to this menu.



1 MENU Select LOCK.



2 Input the password.

- Enter the password as requested.
- The TV is set up with the initial password "0-0-0-0".

Lock System

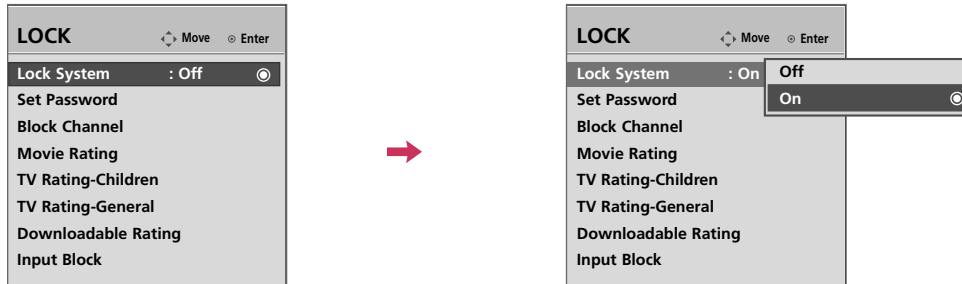
Enables or disables the blocking scheme you set up previously.





1    Select **LOCK**.

2  Input the password.

3  Select **Lock System**.

4   Select **On** or **Off**.

5  Return to the previous menu.

 Return to TV viewing.



- When you select **On**, the Lock System is enable.

PARENTAL CONTROL / RATINGS

Set Password

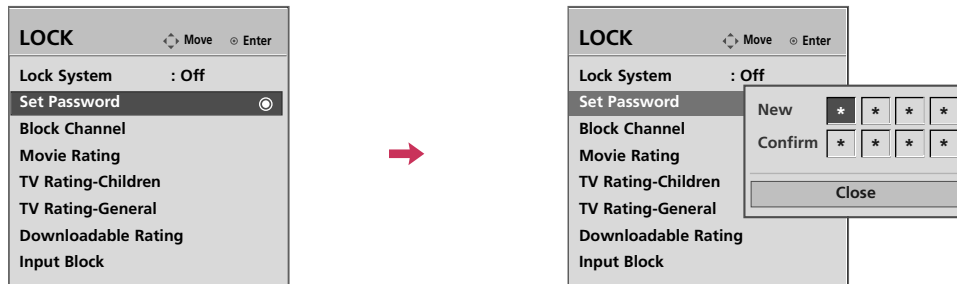
Change the password by inputting a new password twice.



1    Select **LOCK**.

2  Input the password.

3  Select **Set password**.

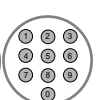
4   Choose any 4 digits for your new password.
As soon as the 4 digits are entered, re-enter the same 4 digits on the **Confirm**.

5  Return to the previous menu.

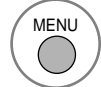
 Return to TV viewing.

CHANNEL BLOCKING

Blocks any channels that you do not want to watch or that you do not want your children to watch.

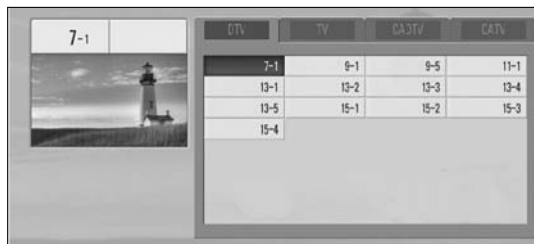
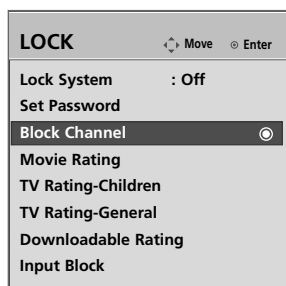

Block/Unblock Move CH Move Page MENU Previous RETURN Exit

1 MENU Select **LOCK**.

2 Input the password.

3 Select **Block Channel**.

4 Select a channel to block or unblock.

5 Block or unblock a channel.

6 MENU Return to the previous menu.

RETURN Return to TV viewing.



PARENTAL CONTROL / RATINGS

MOVIE & TV RATING

Movie Rating (MPAA) - For USA only

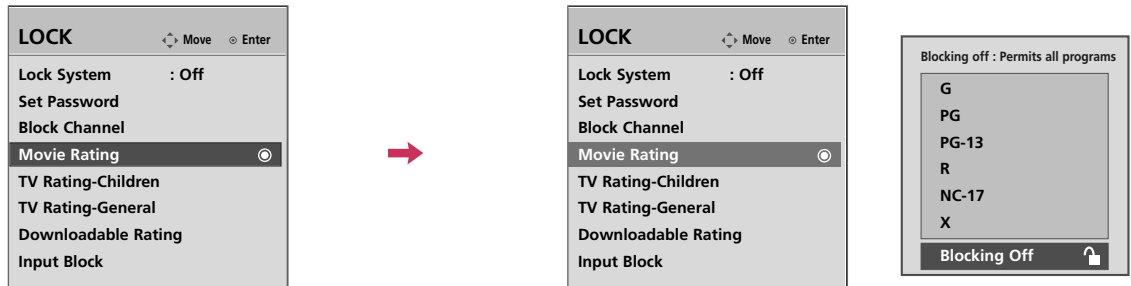
Blocks movies according to the movie ratings limits specified, so children cannot view certain movies. You can set the ratings limit by blocking out all the movies with the ratings above a specified level. Keep in mind that the movie ratings limit only applies to movies shown on TV, not TV programs, such as soap operas.





1    Select **LOCK**.

2  Input the password.

3  Select **Movie Rating**.

4   Select **G, PG, PG-13, R, NC-17, X, or Blocking Off**.

5  Return to the previous menu.



 Return to TV viewing.

- G (General audience)
- PG (Parental guidance suggested)
- PG-13 (Parents strongly cautioned)
- R (Restricted)
- NC-17 (No one 17 and under admitted)
- X (Adult only)
- Blocking Off (Permits all programs)
- ▶ If you set PG-13: G and PG movies will be available, PG-13, R, NC-17 and X will be blocked.

TV Rating Children - For USA only

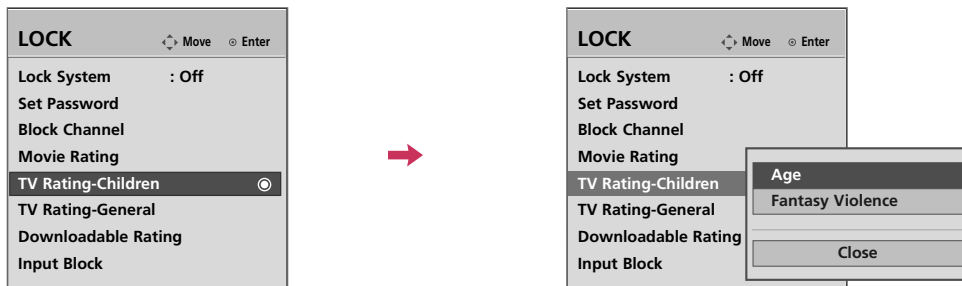
Prevents children from watching certain children's TV programs, according to the ratings limit set. The children rating does not apply to other TV programs. Unless you block certain TV programs intended for mature audiences in the TV Rating - sub menu, your children can view those programs.



1    Select **LOCK**.

2  Input the password.

3  Select **TV Rating-Children**.

4   Select **Age** or **Fantasy Violence**.

5   Select block options.

6  Return to the previous menu.

 Return to TV viewing.



- Age (applies to TV-Y, TV-Y7)
- Fantasy Violence (applies to TV-Y7)

PARENTAL CONTROL / RATINGS

TV Rating General - For USA only

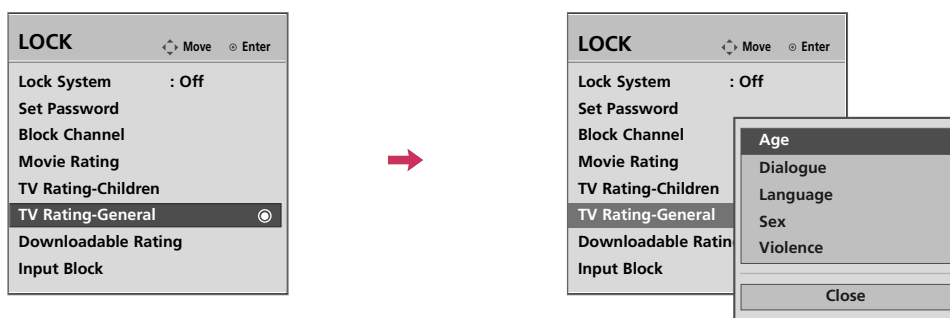
Based on the ratings, blocks certain TV programs that you and your family do not want to view.



1    Select **LOCK**.

2  Input the password.

3  Select **TV Rating-General**.

4   Select **Age, Dialogue, Language, Sex or Violence**.

5   Select block options.

6  Return to the previous menu.



 Return to TV viewing.

- Age (applies to TV-G,TV-PG,TV-14,TV-MA).
- Dialogue-sexual dialogue (applies to TV-PG,TV-14).
- Language-adult language (applies to TV-PG, TV-14, TV-MA).
- Sex-sexual situations (applies to TV-PG, TV-14, TV-MA).
- Violence (applies to TV-PG, TV-14, TV-MA).

TV Rating English - For CANADA only

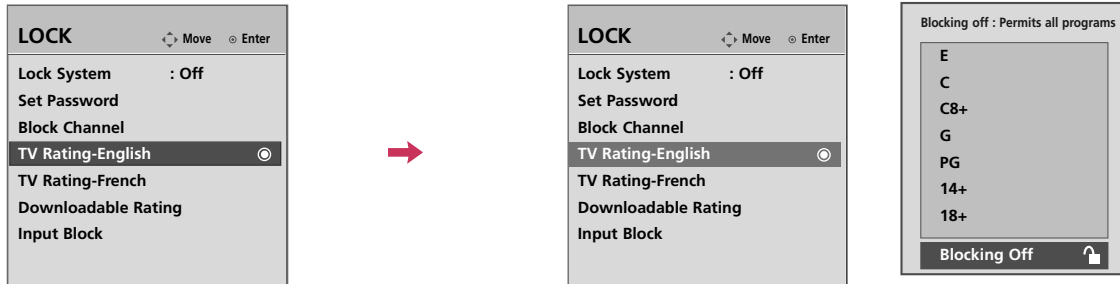

Selecting canadian english language rating system.





1    Select **LOCK**.

2  Input the password.

3  Select **TV Rating-English**.

4   Select **E, C, C8+, G, PG, 14+, 18+, or Blocking Off**.

5  Return to the previous menu.

 Return to TV viewing.

- E (Exempt)
- C (Children)
- C8+ (Children eight years and older)
- G (General programming, suitable for all audiences)
- PG (Parental Guidance)
- 14+ (Viewers 14 years and older)
- 18+ (Adult programming)
- Blocking Off (Permits all programs)

PARENTAL CONTROL / RATINGS

TV Rating French - *For CANADA only*

Selecting canadian french language rating system.

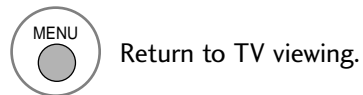
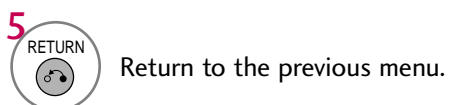
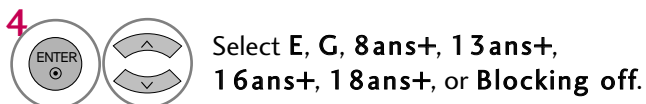
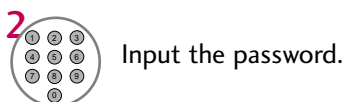
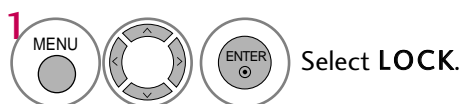
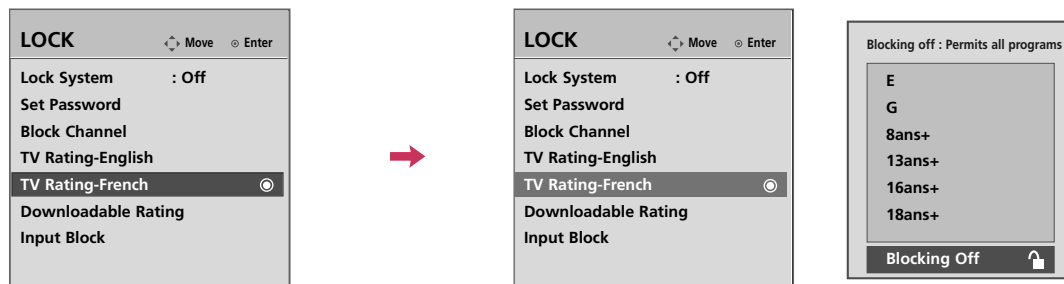







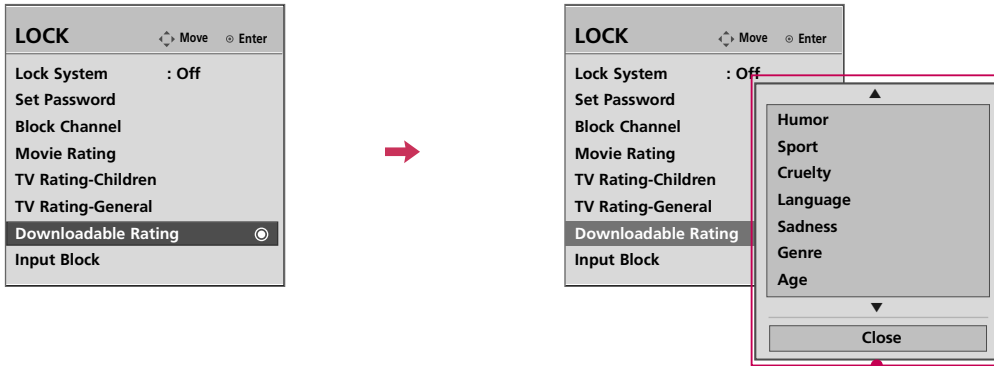



- E (Exempt)
- G (General)
- 8ans+ (General-Not convenient for little children)
- 13ans+ (Not convenient for children of 13 years and younger)
- 16ans+ (Not convenient for children of 16 years and younger)
- 18ans+ (This programs is only for adults)
- Blocking off (Permits all programs)

DOWNLOADABLE RATING

This function may become available in the future and will be available only for digital channels. This function operates only when TV has received Region5 Rating data.



■ Based on rating table, your TV's OSD (On Screen Display) may differ slightly from what is shown in this manual.

-    Select **LOCK**.
-  Input the password.
-  Select **Downloadable Rating**.
-   Select desired **Downloadable Rating** option.
-   Select desired option and block it.
-  Return to the previous menu.
-  Return to TV viewing.

PARENTAL CONTROL / RATINGS

EXTERNAL INPUT BLOCKING

Enables you to block an input.

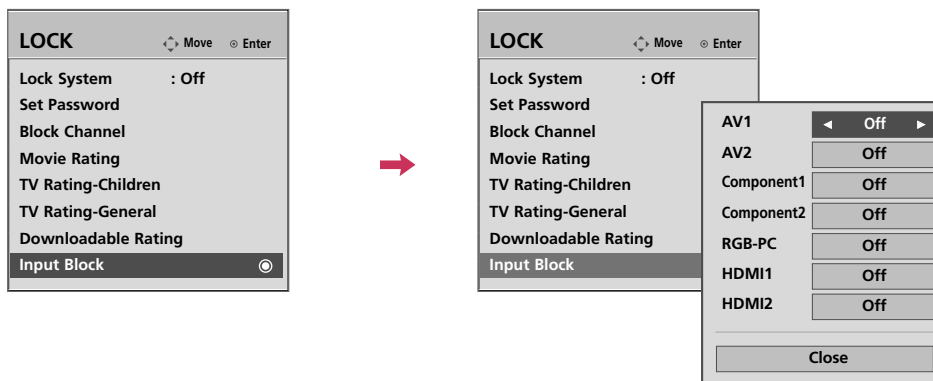

1 MENU Select **LOCK**.

2 Input the password.

3 Select **Input Block**.

4 Select input source.

5 Select **On** or **Off**.

6 RETURN Return to the previous menu.

MENU Return to TV viewing.







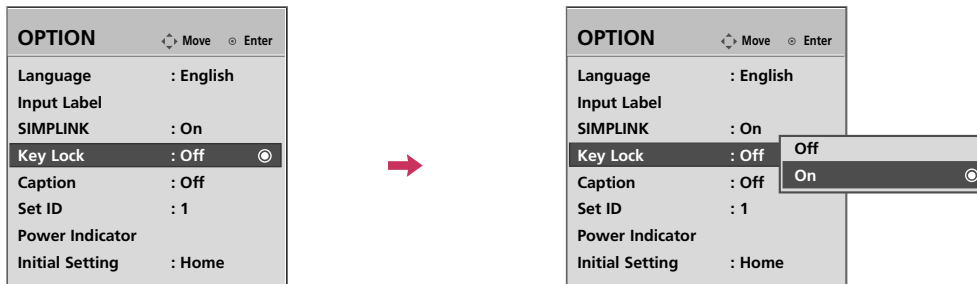

KEY LOCK

The TV can be set up so that it can only be used with the remote control.

This feature can be used to prevent unauthorized viewing by locking out the front panel controls.

This TV is programmed to remember which option it was last set to even if you turn the TV off.



- 1   Select **OPTION**.
- 2   Select **Key Lock**.
- 3   Select **On** or **Off**.
- 4  Return to the previous menu.
-  Return to TV viewing.

- In **Key Lock 'On'**, if the TV is turned off, press the **⏻ / I**, **INPUT**, **CH (▲▼** or **^ v)** button on the TV or **POWER**, **INPUT**, **CH ^ v** or **NUMBER** buttons on the remote control.
- With the **Key Lock On**, the display **'⚠ Key Lock'** appears on the screen if any button on the front panel is pressed while viewing the TV.

APPENDIX

TROUBLESHOOTING

The operation does not work normally.	
The remote control doesn't work	<ul style="list-style-type: none"> ■ Check to see if there is any object between the product and the remote control causing obstruction. Ensure you are pointing the remote control directly at the TV. ■ Ensure that the batteries are installed with correct polarity (+ to +, - to -). ■ Ensure that the correct remote operating mode is set: TV, VCR etc. ■ Install new batteries.
Power is suddenly turned off	<ul style="list-style-type: none"> ■ Is the sleep timer set? ■ Check the power control settings. Power interrupted.

The video function does not work.	
No picture & No sound	<ul style="list-style-type: none"> ■ Check whether the product is turned on. ■ Try another channel. The problem may be with the broadcast. ■ Is the power cord inserted into wall power outlet? ■ Check your antenna direction and/or location. ■ Test the wall power outlet, plug another product's power cord into the outlet where the product's power cord was plugged in.
Picture appears slowly after switching on	<ul style="list-style-type: none"> ■ This is normal, the image is muted during the product startup process. Please contact your service center, if the picture has not appeared after five minutes.
No or poor color or poor picture	<ul style="list-style-type: none"> ■ Adjust Color in menu option. ■ Keep a sufficient distance between the product and the VCR. ■ Try another channel. The problem may be with the broadcast. ■ Are the video cables installed properly? ■ Activate any function to restore the brightness of the picture.
Horizontal/vertical bars or picture shaking	<ul style="list-style-type: none"> ■ Check for local interference such as an electrical appliance or power tool.
Poor reception on some channels	<ul style="list-style-type: none"> ■ Station or cable product experiencing problems, tune to another station. ■ Station signal is weak, reorient antenna to receive weaker station. ■ Check for sources of possible interference.
Lines or streaks in pictures	<ul style="list-style-type: none"> ■ Check antenna (Change the direction of the antenna).
No picture when connecting HDMI	<ul style="list-style-type: none"> ■ Check HDMI cable over version 1.3. The HDMI cables don't support HDMI version 1.3, it cause flickers or no screen display. In this case use the latest cables that support HDMI version 1.3.

The audio function does not work.

Picture OK & No sound	<ul style="list-style-type: none">■ Press the VOL or VOLUME button.■ Sound muted? Press MUTE button.■ Try another channel. The problem may be with the broadcast.■ Are the audio cables installed properly?
No output from one of the speakers	<ul style="list-style-type: none">■ Adjust Balance in menu option.
Unusual sound from inside the product	<ul style="list-style-type: none">■ A change in ambient humidity or temperature may result in an unusual noise when the product is turned on or off and does not indicate a fault with the product.
No sound when connecting HDMI/USB	<ul style="list-style-type: none">■ Check HDMI cable over version 1.3.■ Check USB cable over version 2.0.■ Use normal MP3 file.

There is a problem in PC mode. (Only PC mode applied)

The signal is out of range	<ul style="list-style-type: none">■ Adjust resolution, horizontal frequency, or vertical frequency.■ Check the input source.
Vertical bar or stripe on background & Horizontal Noise & Incorrect position	<ul style="list-style-type: none">■ Work the Auto configure or adjust clock, phase, or H/V position. (Option)
Screen color is unstable or single color	<ul style="list-style-type: none">■ Check the signal cable.■ Reinstall the PC video card.

APPENDIX

MAINTENANCE

Early malfunctions can be prevented. Careful and regular cleaning can extend the amount of time you can enjoy your new TV.

Caution: Be sure to turn the power off and unplug the power cord before you begin any cleaning.

Cleaning the Screen

- 1 Here's a great way to keep the dust off your screen for a while. Wet a soft cloth in a mixture of lukewarm water and a little fabric softener or dish washing detergent. Wring the cloth until it's almost dry, and then use it to wipe the screen.
- 2 Make sure the excess water is off the screen, and then let it air-dry before you turn on your TV.

Cleaning the Cabinet

- To remove dirt or dust, wipe the cabinet with a soft, dry, lint-free cloth.
- Please be sure not to use a wet cloth.

Extended Absence

CAUTION

- ▶ If you expect to leave your TV dormant for a long time (such as a vacation), it's a good idea to unplug the power cord to protect against possible damage from lightning or power surges.

PRODUCT SPECIFICATIONS

MODELS		32LG30DC (32LG30DC-UA)	37LG30DC (37LG30DC-UA)	42LG30DC (42LG30DC-UA)
Dimensions (Width x Height x Depth)	With stand	31.5 x 23.7 x 8.9 inches 801.8 x 604.2 x 227.3 mm	36.2 x 26.8 x 11.5 inches 919.6 x 682.3 x 293.8 mm	40.6 x 29.2 x 11.5 inches 1032.8 x 742.3 x 293.8 mm
	Without stand	31.5 x 21.4 x 3.1 inches 801.8 x 544.1 x 79.0 mm	36.2 x 24.0 x 3.5 inches 919.6 x 610.3 x 89.0 mm	40.6 x 26.3 x 3.6 inches 1032.8 x 670.1 x 92.0 mm
Weight	With stand	29.5 pounds / 13.4 kg	41.4 pounds / 18.8 kg	52.0 pounds / 23.6 kg
	Without stand	26.2 pounds / 11.9 kg	35.7 pounds / 16.2 kg	46.2 pounds / 21.0 kg
MODELS		47LG50DC (47LG50DC-UA)	52LG50DC (52LG50DC-UA)	
Dimensions (Width x Height x Depth)	With stand	45.5 x 32.0 x 13.5 inches 1156.2 x 813.1 x 342.9 mm	50.8 x 35.1 x 13.5 inches 1291.7 x 892.2 x 342.9 mm	
	Without stand	45.5 x 29.1 x 4.0 inches 1156.2 x 739.2 x 103.0 mm	50.8 x 32.1 x 4.5 inches 1291.7 x 817.0 x 115.3 mm	
Weight	With stand	64.3 pounds / 29.2 kg	87.0 pounds / 39.5 kg	
	Without stand	54.2 pounds / 24.6 kg	76.9 pounds / 34.9 kg	
Power requirement Television System Program Coverage External Antenna Impedance		AC100-240V ~ 50/60Hz NTSC-M, ATSC, 64 & 256 QAM VHF 2-13, UHF 14-69, CATV 1-135, DTV 2-69, CADTV 1-135 75 ohm		
Environment condition	Operating Temperature Operating Humidity	32 ~ 104°F (0 ~ 40°C) Less than 80%		
	Storage Temperature Storage Humidity	-4 ~ 140°F (-20 ~ 60°C) Less than 85%		

- The specifications shown above may be changed without prior notice for quality improvement.

PROGRAMMING THE REMOTE CONTROL

The provided universal remote control can be programmed to operate most remote-controllable devices. Note that the remote may not control all models of other brands.

Programming a code into a remote mode

- 1** Testing your remote control.
To find out whether your remote control can operate other components without programming, turn on a component such as a STB and press the corresponding mode button (such as **STB**) on the remote control, while pointing at the component. Test the **POWER** and **CH** \wedge \vee buttons to see if the component responds correctly. If the component does not operate correctly, the remote control requires programming to operate the device.
- 2** Turn on the component to be programmed, then press the corresponding mode button (such as **STB**) on the remote control. The remote control button of the desired device is illuminated.
- 3** Press the **MENU** and **MUTE** buttons simultaneously, and the remote control is ready to be programmed with the code.
- 4** Enter a code number using the number buttons on the remote control. Programming code numbers for the corresponding component can be found on the following pages. If the code is correct, the device will turn off.
- 5** Press the **MENU** button to store the code.
- 6** Test the remote control functions to see if the component responds correctly. If not, repeat from step 2.

Remote Control Code

VCR

Brand	Codes	Brand	Codes	Brand	Codes
AIWA	034	MAGNAVOX	031 033 034 041	SAMSUNG	032 040 102 104
AKAI	016 043 046 124 125 146		067 068		105 107 109 112
AMPRO	072	MARANTZ	012 031 033 067 069		113 115 120 122 125
ANAM	031 033 103	MARTA	101	SANSUI	022 043 048 135
AUDIO DYNAMICS	012 023 039 043	MATSUI	027 030	SANYO	003 007 010 014
BROKSONIC	035 037 129	MEI	031 033		102 134
CANON	028 031 033	MEMOREX	003 010 014 031 033 034 053 072 101 102 134 139	SCOTT	017 037 112 129 131
CAPEHART	108			SEARS	003 008 009 010 013 014 017 020 031 042 073 081 101
CRAIG	003 040 135	MGA	045 046 059	SHARP	031 054 149
CURTIS MATHES	031 033 041	MINOLTA	013 020	SHINTOM	024
DAEWOO	005 007 010 064 065 108 110 111 112 116 117 119	MITSUBISHI	013 020 045 046 049 051 059 061 151	SONY	003 009 031 052 056 057 058 076 077 078 149
DAYTRON	108	MTC	034 040	SOUNDESIGN	034
DBX	012 023 039 043	MULTITECH	024 034	STS	013
DYNATECH	034 053	NEC	012 023 039 043 048	SYLVANIA	031 033 034 059 067
ELECTROHOME	059	NORDMENDE	043	SYMPHONIC	034
EMERSON	006 017 025 027 029 031 034 035 036 037 046 101 129 131 138 153	OPTONICA	053 054	TANDY	010 034
FISHER	003 008 009 010	PANASONIC	066 070 074 083 133 140 145	TATUNG	039 043
FUNAI	034			TEAC	034 039 043
GE	031 033 063 072 107 109 144 147	PENTAX	013 020 031 033 063	TECHNICS	031 033 070
GO VIDEO	132 136	PHILCO	031 034 067	TEKNIKA	019 031 033 034 101
HARMAN KARDON	012 045	PHILIPS	031 033 034 054 067 071 101	THOMAS	034
HITACHI	004 018 026 034 043 063 137 150	PILOT	101	TMK	006
INSTANTREPLAY	031 033	PIONEER	013 021 048	TOSHIBA	008 013 042 047 059 082 112 131
JCL	031 033	PORTLAND	108		
JCPENNY	012 013 015 033 040 066 101	PULSAR	072	TOTEVISION	040 101
JENSEN	043	QUARTZ	011 014	UNITECH	040
JVC	012 031 033 043 048 050 055 060 130 150 152	QUASAR	033 066 075 145	VECTOR RESEARCH	012
KENWOOD	014 034 039 043 047 048	RCA	013 020 033 034 040 041 062 063 107 109 140 144 145 147	VICTOR	048
LG (GOLDSTAR)	001 012 013 020 101 106 114 123	REALISTIC	003 008 010 014 031 033 034 040 053 054 101	VIDEO CONCEPTS	012 034 046
LLOYD	034			VIDEOSONIC	040
LXI	003 009 013 014 017 034 101 106	RICO	058	WARDS	003 013 017 024 031 033 034 040 053 054 131
MAGIN	040	RUNCO	148	YAMAHA	012 034 039 043
		SALORA	014	ZENITH	034 048 056 058 072 080 101

APPENDIX

HDSTB

Brand	Codes	Brand	Codes	Brand	Codes
ALPHASTAR DSR	123	HOUSTON TRACKER	033 037 039 051	PROSAT	072
AMPLICA	050		057 104	RCA	066 106
BIRDVIEW	051 126 129	HUGHES	068	REALISTIC	043 074
CHANNEL MASTER	013 014 015 018 036 055	JANIEL	060 147	SAMSUNG	123
CHAPARRAL	008 009 012 077	JERROLD	061	SATELLITE SERVICE CO	028 035 047 057 085
CITOH	054	KATHREIN	108	SCIENTIFIC ATLANTA	032 138
CURTIS MATHES	050 145	LEGEND	057	SONY	103
DRAKE	005 006 007 010 011 052 112 116 141	LG	001	STARCAST	041
DX ANTENNA	024 046 056 076	LUTRON	132	SUPER GUIDE	020 124 125
ECHOSTAR	038 040 057 058 093 094 095 096 097 098 099 100 122	LUXOR	062 144	TEECOM	023 026 075 087 088 090 107 130 137
ELECTRO HOME	089	MACOM	010 059 063 064 065	TOSHIBA	002 127
EUROPLUS	114	MEMOREX	057	UNIDEN	016 025 042 043 044 045 048 049 078 079 080 086 101 135 136
FUJITSU	017 021 022 027 133 134	NEXTWAVE	028 124 125	VIEWSTAR	115
GENERAL INSTRUMENT	003 004 016 029 031 059 101	NORSAT	069 070	WINEGARD	128 146
HITACHI	139 140	PACE SKY SATELLITE	143	ZENITH	081 082 083 084 091 120
		PANASONIC	060 142		
		PANSAT	121		
		PERSONAL CABLE	117		
		PHILIPS	071		
		PICO	105		
		PRESIDENT	019 102		
		PRIMESTAR	030 110 111		

DVD

Brand	Codes	Brand	Codes	Brand	Codes
APEX DIGITAL	022	MITSUBISHI	002	RCA	005 006
DENON	020 014	NAD	023	SAMSUNG	011 015
GE	005 006	ONKYO	008 017	SONY	007
HARMAN KARDON	027	PANASONIC	003 009	THOMPSON	005 006
JVC	012	PHILIPS	013	TOSHIBA	019 008
LG	001 010 016 025	PIONEER	004 026	YAMAHA	009 018
MAGNAVOX	013	PROCEED	021	ZENITH	010 016 025
MARANTZ	024	PROSCAN	005 006		

IR CODES

1. How to Connect

- Connect your wired remote control to the Remote Control port on the TV.

2. Remote Control IR Codes

■ Output waveform

Single pulse, modulated with 37.917KHz signal at 455KHz

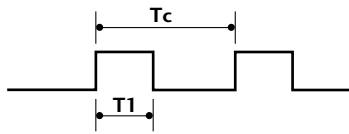

Carrier frequency
 $FCAR = 1/T_c = f_{OSC}/12$
 Duty ratio = $T_1/T_c = 1/3$

■ Configuration of frame

1st frame

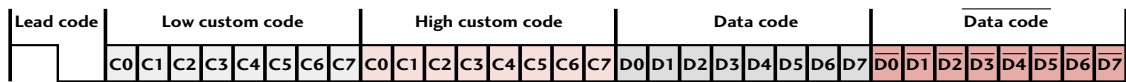

Repeat frame

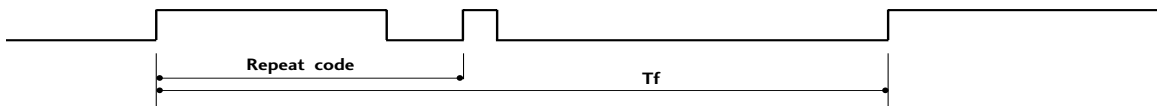

■ Lead code

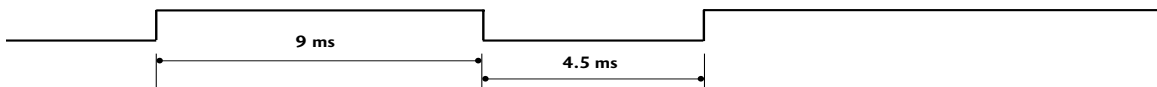

■ Repeat code

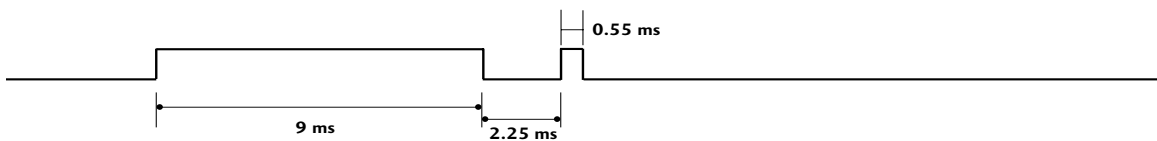

■ Bit description

Bit "0"

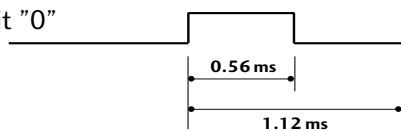

Bit "1"

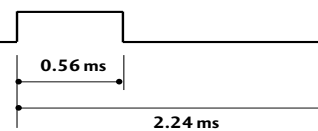

■ Frame interval: Tf

The waveform is transmitted as long as a key is depressed.

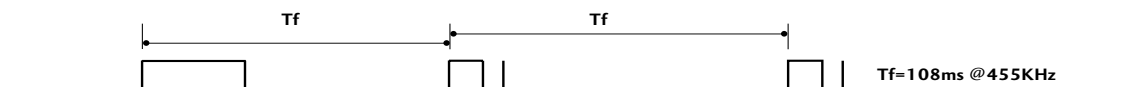

APPENDIX

Code (Hexa)	Function	Note	Code (Hexa)	Function	Note
08	POWER	Remote control Button (Power On/Off)	D6	TV	Discrete IR Code (TV Input Selection)
45	Q.MENU	Remote control Button			
43	MENU	Remote control Button	C4	POWER ON	Discrete IR Code (Only Power On)
0B	INPUT	Remote control Button			
10-19	Number Key 0-9	Remote control Button	C5	POWER OFF	Discrete IR Code (Only Power Off)
4C	- (Dash)	Remote control Button			
1A	FLASHBK	Remote control Button	5A	AV1	Discrete IR Code (AV1 Input Selection)
09	MUTE	Remote control Button			
02	VOL +	Remote control Button	D0	AV2	Discrete IR Code (AV2 Input Selection)
03	VOL -	Remote control Button			
00	CH ^	Remote control Button	BF	COMPONENT1	Discrete IR Code (Component1 Input Selection)
01	CH v	Remote control Button			
1E	FAV	Remote control Button	D4	COMPONENT2	Discrete IR Code (Component2 Input Selection)
40	^	Remote control Button			
41	v	Remote control Button	D5	RGB-PC	Discrete IR Code (RGB-PC Input Selection)
07	<	Remote control Button			
06	>	Remote control Button	CE	HDMI1	Discrete IR Code (HDMI1 Input Selection)
44	ENTER	Remote control Button			
5B	RETURN	Remote control Button	CC	HDMI2	Discrete IR Code (HDMI2 Input Selection)
7E	SIMPLINK	Remote control Button			
30	AV MODE	Remote control Button	76	Ratio 4:3	Discrete IR Code (Only 4:3 Mode)
B0	PLAY	Remote control Button			
BA	PAUSE	Remote control Button	77	Ratio 16:9	Discrete IR Code (Only 16:9 Mode)
B1	STOP	Remote control Button			
BD	REC	Remote control Button	AF	Ratio Zoom	Discrete IR Code (Only Zoom1 Mode)
8F	REW	Remote control Button			
8E	FF	Remote control Button			

EXTERNAL CONTROL THROUGH RS-232C

The RS-232C port allows you connect the RS-232C input jack to an external control device (such as a computer or an A/V control system) to control the TV's functions externally.

- Note: RS-232C on this unit is intended to be used with third party RS-232C control hardware and software. The instructions below are provided to help with programming software or to test functionality using telenet software.

RS-232C Setup

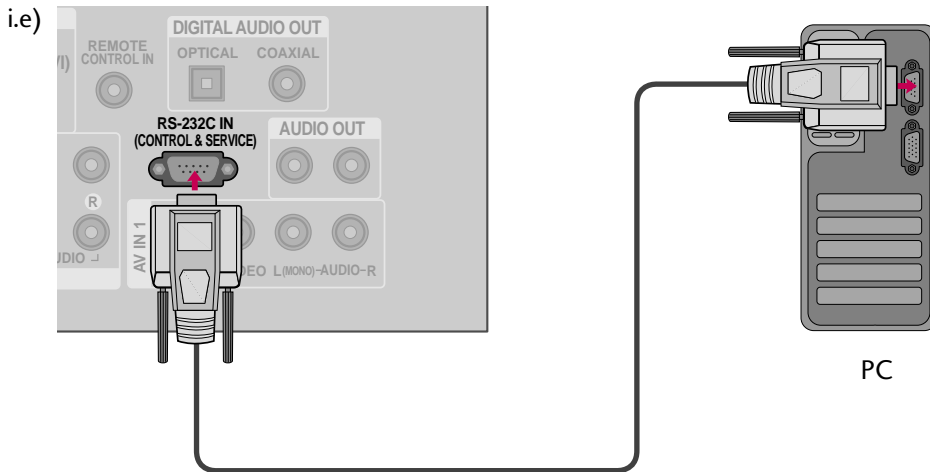

Type of Connector; D-Sub 9-Pin Male

No.	Pin Name
1	No connection
2	RXD (Receive data)
3	TXD (Transmit data)
4	DTR (DTE side ready)
5	GND
6	DSR (DCE side ready)
7	RTS (Ready to send)
8	CTS (Clear to send)
9	No Connection

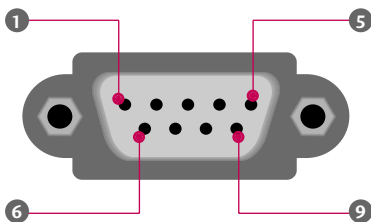

Communication Parameters

- Baud rate : 9600 bps (UART)
- Data length : 8 bits
- Parity : None
- Stop bit : 1 bit
- Communication code : ASCII code
- Use a crossed (reverse) cable.

! NOTE

- ▶ This product has command echo back in the RS-232C Command.

APPENDIX

RS-232C Configurations



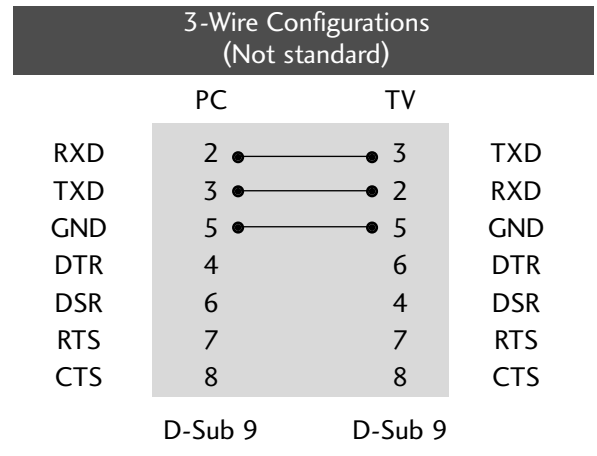
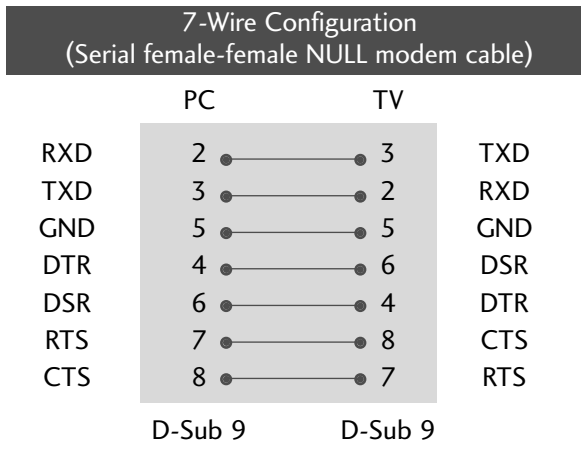



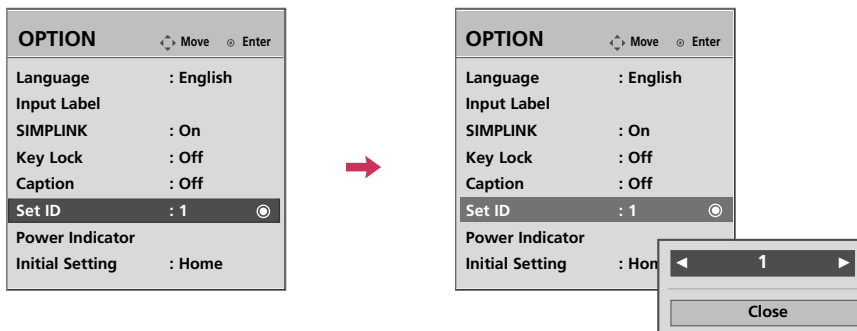

Either cable below can be used.



Set ID

Use this function to specify a TV ID number.
Refer to 'Real Data Mapping'. ► p.113.



- 1   Select **OPTION**.
- 2   Select **Set ID**.
- 3   Choose the desired TV ID number.
The adjustment range of Set ID is 1~99.
- 4  Return to the previous menu.
-  Return to TV viewing.

Command Reference List

	COMMAND1	COMMAND2	DATA (Hexadecimal)		COMMAND1	COMMAND2	DATA (Hexadecimal)
01. Power	k	a	00 ~ 01	14. Treble	k	r	00 ~ 64
02. Input Select	x	b	(▶ p.112)	15. Bass	k	s	00 ~ 64
03. Aspect Ratio	k	c	(▶ p.112)	16. Balance	k	t	00 ~ 64
04. Screen Mute	k	d	00 ~ 01	17. Color Temperature	k	u	00 ~ 02
05. Volume Mute	k	e	00 ~ 01	18. Auto Configuration	j	u	(▶ p.114)
06. Volume Control	k	f	00 ~ 64	20. Channel Add/Del	m	b	00 ~ 01
07. Contrast	k	g	00 ~ 64	21. Key	m	c	(▶ p.115)
08. Brightness	k	h	00 ~ 64	22. Backlight	m	g	00 ~ 64
09. Color	k	i	00 ~ 64				
10. Tint	k	j	00 ~ 64				
11. Sharpness	k	k	00 ~ 64				
12. OSD Select	k	l	00 ~ 01				
13. Remote Control Lock Mode	k	m	00 ~ 01				

	COMMAND1	COMMAND2	DATA00 (Hexadecimal)	DATA01 (Hexadecimal)	DATA02 (Hexadecimal)	DATA03 (Hexadecimal)	DATA04 (Hexadecimal)	DATA05 (Hexadecimal)
19. Channel Tuning	m	a	physical program high	major program low	major low	minor high	minor low	attribute

Transmission / Receiving Protocol

Transmission

[Command1][Command2][][Set ID][][Data][Cr]

[Command 1] : First command to control the set.(j, k, m or x)

[Command 2] : Second command to control the set.

[Set ID] : You can adjust the set ID to choose desired TV ID number in Setup menu. Adjustment range is 1 ~ 99. When selecting Set ID '0', every connected the TV is controlled. Set ID is indicated as decimal (1 ~ 99) on menu and as Hexa decimal (0x0~0x63) on transmission /receiving protocol.

[DATA] : To transmit the command data.

Transmit the 'FF' data to read status of command.

[Cr] : Carriage Return

ASCII code '0x0D'

[] : ASCII code 'space (0x20)'

* In this model, TV will not send the status during the standby mode.

OK Acknowledgement

[Command2][][Set ID][][OK][Data][x]

The TV transmits ACK (acknowledgement) based on this format when receiving normal data. At this time, if the data is data read mode, it indicates present status data. If the data is data write mode, it returns the data of the PC computer.

* In this model, TV will not send the status during the standby mode.

* Data Format

[Command 2] : Use as command.

[Set ID] : Use the small character, if set ID is 10, it will send the '0', 'a'.

[DATA] : Use the small character, if data is 0 x ab, it will send the 'a', 'b'.

[OK] : Use the large character.

Error Acknowledgement

[Command2][][Set ID][][NG][Data][x]

The TV transmits ACK (acknowledgement) based on this format when receiving abnormal data from non-viable functions or communication errors.

Data1: Illegal Code

Data2: Not supported function

Data3: Wait more time

* In this model, TV will not send the status during the standby mode.

* Data Format

[Command 2] : Use as command.

[Set ID] : Use the small character, if set ID is 10, it will send the '0', 'a'.

[DATA] : Use the small character, if data is 0 x ab, it will send the 'a', 'b'.

[NG] : Use the large character

01. Power (Command: k a)

To control Power On/Off of the TV.

Transmission [k][a][][Set ID][][Data][Cr]

Data 00: Power Off Data 01: Power On

Acknowledgement [a][][Set ID][][OK/NG][Data][x]

* In a like manner, if other functions transmit 'FF' data based on this format, Acknowledgement data feedback presents status about each function.

* Note: In this model, TV will send the Acknowledge after power on processing completion.

There might be a time delay between command and acknowledge.

02. Input Select (Command: x b)

To select input source for TV.

Transmission [x][b][][Set ID][][Data][Cr]

Data 00: DTV (Antenna) Data 01: DTV (Cable)
 Data 10: Analog (Antenna) Data 11: Analog (Cable)
 Data 20: AV1 Data 21: AV2
 Data 40: Component 1 Data 41: Component 2
 Data 60: RGB-PC Data 90: HDMI1
 Data 91: HDMI2

Acknowledgement [b][][Set ID][][OK/NG][Data][x]

* Use the feature depending on your model.

03. Aspect Ratio (Command: k c)

To adjust the screen format.

Transmission [k][c][][Set ID][][Data][Cr]

Data 01: 4:3 05: Zoom 2
 02: 16:9 06: Set by program
 04: Zoom 1 09: Just scan
 ⋮
 Reserved

Acknowledgement [c][][Set ID][][OK/NG][Data][x]

04. Screen Mute (Command: k d)

To select screen mute on/off.

Transmission [k][d][][Set ID][][Data][Cr]

Data 00: Screen mute off (Picture on)
 Data 01: Screen mute on (Picture off)

Acknowledgement [d][][Set ID][][OK/NG][Data][x]

05. Volume Mute (Command: k e)

To control volume mute on/off.

You can also adjust mute using the MUTE button on remote control.

Transmission [k][e][][Set ID][][Data][Cr]

Data 00: Volume mute on (Volume off)
 Data 01: Volume mute off (Volume on)

Acknowledgement [e][][Set ID][][OK/NG][Data][x]

06. Volume Control (Command: k f)

To adjust volume.

You can also adjust volume with the volume buttons on remote control.

Transmission [k][f][][Set ID][][Data][Cr]

Data Min: 00 ~ Max: 64 (*transmit by Hexadecimal code)
 *Refer to 'Real data mapping'. See page 113.

Acknowledgement [f][][Set ID][][OK/NG][Data][x]

07. Contrast (Command: k g)

To adjust screen contrast.

You can also adjust contrast in the PICTURE menu.

Transmission [k][g][][Set ID][][Data][Cr]

Data Min: 00 ~ Max: 64 (*transmit by Hexadecimal code)
 *Refer to 'Real data mapping'. See page 113.

Acknowledgement [g][][Set ID][][OK/NG][Data][x]

08. Brightness (Command: k h)

To adjust screen brightness.

You can also adjust brightness in the PICTURE menu.

Transmission [k][h][][Set ID][][Data][Cr]

Data Min: 00 ~ Max: 64 (*transmit by Hexadecimal code)
 *Refer to 'Real data mapping'. See page 113.

Acknowledgement [h][][Set ID][][OK/NG][Data][x]

09. Color (Command: k i)

To adjust screen color.

You can also adjust color in the PICTURE menu.

Transmission [k][i][][Set ID][][Data][Cr]

Data Min: 00 ~ Max: 64 (*transmit by Hexadecimal code)

*Refer to 'Real data mapping' as shown below.

Acknowledgement [i][][Set ID][][OK/NG][Data][x]

10. Tint (Command: k j)

To adjust screen tint.

You can also adjust tint in the PICTURE menu.

Transmission [k][j][][Set ID][][Data][Cr]

Data Red: 00 ~ Green: 64 (*transmit by Hexadecimal code)

*Refer to 'Real data mapping' as shown below.

Acknowledgement [j][][Set ID][][OK/NG][Data][x]

11. Sharpness (Command: k k)

To adjust screen sharpness.

You can also adjust sharpness in the PICTURE menu.

Transmission [k][k][][Set ID][][Data][Cr]

Data Min: 00 ~ Max: 64 (*transmit by Hexadecimal code)

*Refer to 'Real data mapping' as shown below.

Acknowledgement [k][][Set ID][][OK/NG][Data][x]

12. OSD Select (Command: k l)

To select OSD (On Screen Display) on/off.

Transmission [k][l][][Set ID][][Data][Cr]

Data 00: OSD off Data 01: OSD on

Acknowledgement [l][][Set ID][][OK/NG][Data][x]

13. Remote Control Lock Mode (Command: k m)

To lock the remote control and the front panel controls on the set.

Transmission [k][m][][Set ID][][Data][Cr]

Data 00: Lock off Data 01: Lock on

Acknowledgement [m][][Set ID][][OK/NG][Data][x]

If you're not using the remote control and front panel controls on the TV, use this mode. When main power is on/off, remote control lock is released.

14. Treble (Command: k r)

To adjust treble.

You can also adjust treble in the AUDIO menu.

Transmission [k][r][][Set ID][][Data][Cr]

Data Min: 00 ~ Max: 64 (*transmit by Hexadecimal code)

*Refer to 'Real data mapping' as shown.

Acknowledgement [r][][Set ID][][OK/NG][Data][x]

15. Bass (Command: k s)

To adjust bass.

You can also adjust bass in the AUDIO menu.

Transmission [k][s][][Set ID][][Data][Cr]

Data Min: 00 ~ Max: 64 (*transmit by Hexadecimal code)

*Refer to 'Real data mapping' as shown below.

Acknowledgement [s][][Set ID][][OK/NG][Data][x]

16. Balance (Command: k t)

To adjust balance.

You can also adjust balance in the AUDIO menu.

Transmission [k][t][][Set ID][][Data][Cr]

Data Min: 00 ~ Max: 64 (*transmit by Hexadecimal code)

*Refer to 'Real data mapping' as shown below.

Acknowledgement [t][][Set ID][][OK/NG][Data][x]

17. Color Temperature (Command: k u)

To adjust color temperature.

You can also adjust color temperature in the PICTURE menu.

Transmission [k][u][][Set ID][][Data][Cr]

Data 00: Medium 01: Cool 02: Warm

Acknowledgement [u][][Set ID][][OK/NG][Data][x]

*Real data mapping

0 : Step 0

⋮

A : Step 10 (SET ID 10)

⋮

F : Step 15 (SET ID 15)

10 : Step 16 (SET ID 16)

⋮

63 : Step 99 (SET ID 99)

64 : Step 100

18. Auto Configuration (Command: j u)

To adjust picture position and minimize image shaking automatically. Auto configuration only works in RGB-PC mode.

Transmission [j][u][][Set ID][][Data][Cr]

Data 1: To set

Acknowledgement [u][][Set ID][][OK/NG][Data][x]

19. Channel Tuning (Command: m a)

To tune channel to following physical/major/minor number.

Transmission [m][a][][Set ID][][Data00][][Data01][][Data02][][Data03][][Data04][][Data05][Cr]

Digital channels have a Physical, Major, and Minor channel number. The Physical number is the actual digital channel number, the Major is the number that the channel should be mapped to, and the Minor is the sub-channel. Since the ATSC tuner automatically maps the channel to the Major number, the Physical number is not required when sending a command.

Data 00: Physical Channel Number

NTSC air: 02~45, NTSC cable: 01, 0E~7D

ATSC air: 01~45, ATSC cable: 01~87

Data 01 & 02: Major Channel Number

Data 01: High byte Data 02: Low byte

Two bytes are available for the Major and Minor, normally only the second byte is used.

Data 03 & 04: Minor Channel Number

Not needed for NTSC.

Data05:

7	Main/Sub Picture	6	Two/One Part Channel	5	Using Physical Channel	4	Reserved	3	2	1	0	Step
0	Main	0	Two	0	Use	x		0	0	0	0	NTSC Air
1	Sub	1	One	1	No Use	x		0	0	0	1	NTSC Cable
						x		0	0	1	0	ATSC Air
						x		0	0	1	1	ATSC Cable_std
						x		0	1	0	0	ATSC Cable_hrc
						x		0	1	0	1	ATSC Cable_irc
						x		0	1	1	0	ATSC cable_auto
						x		0	1	1	1	Reserved
						x		x	x	x	x	...
						x		1	1	1	1	Reserved

The table above lists the binary code which must be converted to Hexadecimal before sending. For example: The binary code to tune the sub source to an NTSC cable channel is "1000 0001", which translates to "81" in Hex.

- * 7th bit : For which source do you want to change the channel.
- * 6th bit: Use a two part or one part channel. Most cases just use 0 since it's ignored when using NTSC.
- * 5th bit: Use 0 with NTSC since it can only use the physical channel number. Normally use 1 for ATSC since most times it doesn't matter what the physical number is.
- * 4th bit: Set to 0.
- * 3-0 bits: Choose signal type.

* Tune Command Examples:

1. Tune to the analog (NTSC) cable channel 35.

Data 00 = Physical of 35 = 23
 Data 01 & 02 = No Major = 00 00
 Data 03 & 04 = No Minor = 00 00
 Data 05 = 0000 0001 in binary = 01
 Total = ma 00 23 00 00 00 00 01

2. Tune to the digital (ATSC) local channel 30-3.

Data 00 = Don't know Physical = 00
 Data 01 & 02 = Major is 30 = 00 1E
 Data 03 & 04 = Minor is 3 = 00 03
 Data 05 = 0010 0010 in binary = 22
 Total = ma 00 00 00 1E 00 03 22

```
Acknowledgement[a][ ][Set ID][ ][OK][Data00][Data01]
[Data02][Data03][Data04][x][a][ ][Set ID]
[ ][NG][Data00][x]
```

20. Channel Add/Del (Command: m b)

To add and delete the channels

```
Transmission [m][b][ ][Set ID][ ][Data][Cr]
```

Data 00: Channel Delete Data 01: Channel Add

```
Acknowledgement [b][ ][Set ID][ ][OK/NG][Data][x]
```

21. Key (Command: m c)

To send IR remote key code.

```
Transmission [m][c][ ][Set ID][ ][Data][Cr]
```

Data Key code: Refer to page 108.

```
Acknowledgement [c][ ][Set ID][ ][OK/NG][Data][x]
```

22. Backlight (Command: m g)

To adjust screen backlight.

```
Transmission [m][g][ ][Set ID][ ][Data][Cr]
```

Data Min:00 ~ Max:64 (*transmit by Hexadecimal code)

*Refer to 'Real data mapping.' See page 113.

```
Acknowledgement [g][ ][Set ID][ ][OK/NG][Data][x]
```

OPEN SOURCE LICENSE - *This feature is not available for all models.*

GNU GENERAL PUBLIC LICENSE

Version 2, June 1991

Copyright (C) 1989, 1991 Free Software Foundation, Inc., 51 Franklin Street, Fifth Floor, Boston, MA 02110-1301 USA

Everyone is permitted to copy and distribute verbatim copies of this license document, but changing it is not allowed.

Preamble

The licenses for most software are designed to take away your freedom to share and change it. By contrast, the GNU General Public License is intended to guarantee your freedom to share and change free software - to make sure the software is free for all its users. This General Public License applies to most of the Free Software Foundation's software and to any other program whose authors commit to using it. (Some other free software foundation software is covered by the GNU Lesser General Public License instead.) You can apply it to your programs, too.

When we speak of free software, we are referring to freedom, not price. Our General Public Licenses are designed to make sure that you have the freedom to distribute copies of free software (and charge for this service if you wish), that you receive source code or can get it if you want it, that you can change the software or use pieces of it in new free programs; and that you know you can do these things.

To protect your rights, we need to make restrictions that forbid anyone to deny you these rights or to ask you to surrender the rights. These restrictions translate to certain responsibilities for you if you distribute copies of the software, or if you modify it.

For example, if you distribute copies of such a program, whether gratis or for a fee, you must give the recipients all the rights that you have. You must make sure that they, too, receive or can get the source code. And you must show them these terms so they know their rights.

We protect your rights with two steps: (1) copyright the software, and (2) offer you this license which gives you legal permission to copy, distribute and/or modify the software.

Also, for each author's protection and ours, we want to make certain that everyone understands that there is no warranty for this free software. If the software is modified by someone else and passed on, we want its recipients to know that what they have is not the original, so that any problems introduced by others will not reflect on the original authors' reputations.

Finally, any free program is threatened constantly by software patents. We wish to avoid the danger that redistributors of a free program will individually obtain patent licenses, in effect making

the program proprietary. To prevent this, we have made it clear that any patent must be licensed for everyone's free use or not licensed at all.

The precise terms and conditions for copying, distribution and modification follow.

GNU GENERAL PUBLIC LICENSE

TERMS AND CONDITIONS FOR COPYING, DISTRIBUTION AND MODIFICATION

0. This license applies to any program or other work which contains a notice placed by the copyright holder saying it may be distributed under the terms of this General Public License. The "Program", below, refers to any such program or work, and a "work based on the Program" means either the Program or any derivative work under copyright law: that is to say, a work containing the Program or a portion of it, either verbatim or with modifications and/or translated into another language. (Hereinafter, translation is included without limitation in the term "modification".) Each licensee is addressed as "you".

Activities other than copying, distribution and modification are not covered by this license; they are outside its scope. The act of running the Program is not restricted, and the output from the program is covered only if its contents constitute a work based on the program (independent of having been made by running the program). Whether that is true depends on what the program does.

1. You may copy and distribute verbatim copies of the program's source code as you receive it, in any medium, provided that you conspicuously and appropriately publish on each copy an appropriate copyright notice and disclaimer of warranty; keep intact all the notices that refer to this license and to the absence of any warranty; and give any other recipients of the program a copy of this license along with the Program.

You may charge a fee for the physical act of transferring a copy, and you may at your option offer warranty protection in exchange for a fee.

2. You may modify your copy or copies of the program or any portion of it, thus forming a work based on the Program, and copy and distribute such modifications or work under the terms of section 1 above, provided that you also meet all of these conditions:

a) You must cause the modified files to carry prominent notices stating that you changed the files and the date of any change.

- b) You must cause any work that you distribute or publish, that in whole or in part contains or is derived from the Program or any part thereof, to be licensed as a whole at no charge to all third parties under the terms of this license.
- c) If the modified program normally reads commands interactively when run, you must cause it, when started running for such interactive use in the most ordinary way, to print or display an announcement including an appropriate copyright notice and a notice that there is no warranty (or else, saying that you provide a warranty) and that users may redistribute the program under these conditions, and telling the user how to view a copy of this license. (Exception: if the Program itself is interactive but does not normally print such an announcement, your work based on the Program is not required to print an announcement.)

These requirements apply to the modified work as a whole. If identifiable sections of that work are not derived from the Program, and can be reasonably considered independent and separate works in themselves, then this license, and its terms, do not apply to those sections when you distribute them as separate works. But when you distribute the same sections as part of a whole which is a work based on the Program, the distribution of the whole must be on the terms of this license, whose permissions for other licensees extend to the entire whole, and thus to each and every part regardless of who wrote it.

Thus, it is not the intent of this section to claim rights or contest your rights to work written entirely by you; rather, the intent is to exercise the right to control the distribution of derivative or collective works based on the program.

In addition, mere aggregation of another work not based on the program with the Program (or with a work based on the program) on a volume of a storage or distribution medium does not bring the other work under the scope of this license.

- 3. You may copy and distribute the program (or a work based on it, under section 2) in object code or executable form under the terms of sections 1 and 2 above provided that you also do one of the following:
 - a) Accompany it with the complete corresponding machine-readable source code, which must be distributed under the terms of sections 1 and 2 above on a medium customarily used for software interchange; or
 - b) Accompany it with a written offer, valid for at least three years, to give any third party, for a charge no more than your cost of physically performing source distribution, a complete machine-readable copy of the corresponding source code, to be distributed under the terms of sections 1 and 2 above on a medium customarily used for software interchange; or,

- c) Accompany it with the information you received as to the offer to distribute corresponding source code. (This alternative is allowed only for noncommercial distribution and only if you received the program in object code or executable form with such an offer, in accord with Subsection b above.)

The source code for a work means the preferred form of the work for making modifications to it. For an executable work, complete source code means all the source code for all modules it contains, plus any associated interface definition files, plus the scripts used to control compilation and installation of the executable. However, as a special exception, the source code distributed need not include anything that is normally distributed (in either source or binary form) with the major components (compiler, kernel, and so on) of the operating system on which the executable runs, unless that component itself accompanies the executable.

If distribution of executable or object code is made by offering access to copy from a designated place, then offering equivalent access to copy the source code from the same place counts as distribution of the source code, even though third parties are not compelled to copy the source along with the object code.

- 4. You may not copy, modify, sublicense, or distribute the Program except as expressly provided under this license. Any attempt otherwise to copy, modify, sublicense or distribute the Program is void, and will automatically terminate your rights under this license. However, parties who have received copies, or rights, from you under this license will not have their licenses terminated so long as such parties remain in full compliance.
- 5. You are not required to accept this license, since you have not signed it. However, nothing else grants you permission to modify or distribute the Program or its derivative works. These actions are prohibited by law if you do not accept this license. Therefore, by modifying or distributing the program (or any work based on the program), you indicate your acceptance of this license to do so, and all its terms and conditions for copying, distributing or modifying the program or works based on it.
- 6. Each time you redistribute the program (or any work based on the Program), the recipient automatically receives a license from the original licensor to copy, distribute or modify the Program subject to these terms and conditions. You may not impose any further restrictions on the recipients' exercise of the rights granted herein. You are not responsible for enforcing compliance by third parties to this license.

7. If, as a consequence of a court judgment or allegation of patent infringement or for any other reason (not limited to patent issues), conditions are imposed on you (whether by court order, agreement or otherwise) that contradict the conditions of this license, they do not excuse you from the conditions of this license. If you cannot distribute so as to satisfy simultaneously your obligations under this license and any other pertinent obligations, then as a consequence you may not distribute the program at all. For example, if a patent license would not permit royalty-free redistribution of the program by all those who receive copies directly or indirectly through you, then the only way you could satisfy both it and this license would be to refrain entirely from distribution of the program.

If any portion of this section is held invalid or unenforceable under any particular circumstance, the balance of the section is intended to apply and the section as a whole is intended to apply in other circumstances.

It is not the purpose of this section to induce you to infringe any patents or other property right claims or to contest validity of any such claims; this section has the sole purpose of protecting the integrity of the free software distribution system, which is implemented by public license practices. Many people have made generous contributions to the wide range of software distributed through that system in reliance on consistent application of that system; it is up to the author/donor to decide if he or she is willing to distribute software through any other system and a licensee cannot impose that choice.

This section is intended to make thoroughly clear what is believed to be a consequence of the rest of this license.

8. If the distribution and/or use of the program is restricted in certain countries either by patents or by copyrighted interfaces, the original copyright holder who places the program under this license may add an explicit geographical distribution limitation excluding those countries, so that distribution is permitted only in or among countries not thus excluded. In such case, this license incorporates the limitation as if written in the body of this license.
9. The Free Software Foundation may publish revised and/or new versions of the General Public License from time to time. Such new versions will be similar in spirit to the present version, but may differ in detail to address new problems or concerns.

Each version is given a distinguishing version number. If the program specifies a version number of this license which applies to it and "any later version", you have the option of following the terms and conditions either of that version or of

any later version published by the Free Software Foundation. If the program does not specify a version number of this license, you may choose any version ever published by the Free Software Foundation.

10. If you wish to incorporate parts of the program into other free programs whose distribution conditions are different, write to the author to ask for permission. For software which is copyrighted by the Free Software Foundation, write to the Free Software Foundation; we sometimes make exceptions for this. Our decision will be guided by the two goals of preserving the free status of all derivatives of our free software and of promoting the sharing and reuse of software generally.

NO WARRANTY

11. BECAUSE THE PROGRAM IS LICENSED FREE OF CHARGE, THERE IS NO WARRANTY FOR THE PROGRAM, TO THE EXTENT PERMITTED BY APPLICABLE LAW. EXCEPT WHEN OTHERWISE STATED IN WRITING THE COPYRIGHT HOLDERS AND/OR OTHER PARTIES PROVIDE THE PROGRAM "AS IS" WITHOUT WARRANTY OF ANY KIND, EITHER EXPRESSED OR IMPLIED, INCLUDING, BUT NOT LIMITED TO, THE IMPLIED WARRANTIES OF MERCHANTABILITY AND FITNESS FOR A PARTICULAR PURPOSE. THE ENTIRE RISK AS TO THE QUALITY AND PERFORMANCE OF THE PROGRAM IS WITH YOU. SHOULD THE PROGRAM PROVE DEFECTIVE, YOU ASSUME THE COST OF ALL NECESSARY SERVICING, REPAIR OR CORRECTION.
12. IN NO EVENT UNLESS REQUIRED BY APPLICABLE LAW OR AGREED TO IN WRITING WILL ANY COPYRIGHT HOLDER, OR ANY OTHER PARTY WHO MAY MODIFY AND/OR REDISTRIBUTE THE PROGRAM AS PERMITTED ABOVE, BE LIABLE TO YOU FOR DAMAGES, INCLUDING ANY GENERAL, SPECIAL, INCIDENTAL OR CONSEQUENTIAL DAMAGES ARISING OUT OF THE USE OR INABILITY TO USE THE PROGRAM (INCLUDING BUT NOT LIMITED TO LOSS OF DATA OR DATA BEING RENDERED INACCURATE OR LOSSES SUSTAINED BY YOU OR THIRD PARTIES OR A FAILURE OF THE PROGRAM TO OPERATE WITH ANY OTHER PROGRAMS), EVEN IF SUCH HOLDER OR OTHER PARTY HAS BEEN ADVISED OF THE POSSIBILITY OF SUCH DAMAGES.

END OF TERMS AND CONDITIONS

How to apply these terms to your new programs

If you develop a new program, and you want it to be of the greatest possible use to the public, the best way to achieve this is to make it free software which everyone can redistribute and change under these terms.

To do so, attach the following notices to the program. It is safest to attach them to the start of each source file to most effectively convey the exclusion of warranty; and each file should have at least the "copyright" line and a pointer to where the full notice is found.

one line to give the program's name and a brief idea of what it does.

Copyright (C) <year> <name of author>

This program is free software; you can redistribute it and/or modify it under the terms of the GNU General Public License as published by the Free Software Foundation; either version 2 of the license, or (at your option) any later version.

This program is distributed in the hope that it will be useful, but WITHOUT ANY WARRANTY; without even the implied warranty of MERCHANTABILITY or FITNESS FOR A PARTICULAR PURPOSE. See the GNU General Public License for more details.

You should have received a copy of the GNU General Public License along with this program; if not, write to the Free Software Foundation, Inc., 51 Franklin Street, Fifth Floor, Boston, MA 02110-1301 USA.

Also add information on how to contact you by electronic and paper mail.

If the program is interactive, make it output a short notice like this when it starts in an interactive mode:

Gnomovision version 69, Copyright (C) year name of author
Gnomovision comes with ABSOLUTELY NO WARRANTY; for details type 'show w'. This is free software, and you are welcome to redistribute it under certain conditions; type 'show c' for details.

The hypothetical commands 'show w' and 'show c' should show the appropriate parts of the General Public License. Of course, the commands you use may be called something other than 'show w' and 'show c'; they could even be mouse-clicks or menu items-whatever suits your program.

You should also get your employer (if you work as a programmer) or your school, if any, to sign a "copyright disclaimer" for the program, if necessary. Here is a sample; alter the names:

Yoyodyne, Inc., hereby disclaims all copyright interest in the program 'Gnomovision' (which makes passes at compilers) written by James Hacker.

signature of Ty Coon, 1 April 1989
Ty Coon, President of Vice

This General Public License does not permit incorporating your program into proprietary programs. If your program is a subroutine library, you may consider it more useful to permit linking proprietary applications with the library. If this is what you want to do, use the GNU Lesser General Public License instead of this license.

GNU LESSER GENERAL PUBLIC LICENSE

Version 2.1, February 1999

Copyright (C) 1991, 1999 Free Software Foundation, Inc. 51 Franklin Street, Fifth Floor, Boston, MA 02110-1301 USA
Everyone is permitted to copy and distribute verbatim copies of this license document, but changing it is not allowed.

[This is the first released version of the Lesser GPL. It also counts as the successor of the GNU Library Public License, version 2, hence the version number 2.1.]

Preamble

The licenses for most software are designed to take away your freedom to share and change it. By contrast, the GNU General Public Licenses are intended to guarantee your freedom to share and change free software - to make sure the software is free for all its users.

This license, the Lesser General Public License, applies to some specially designated software packages - typically libraries - of the Free Software Foundation and other authors who decide to use it. You can use it too, but we suggest you first think carefully about whether this license or the ordinary General Public License is the better strategy to use in any particular case, based on the explanations below.

When we speak of free software, we are referring to freedom of use, not price. Our General Public Licenses are designed to make sure that you have the freedom to distribute copies of free software (and charge for this service if you wish); that you receive source code or can get it if you want it; that you can change the software and use pieces of it in new free programs; and that you are informed that you can do these things.

To protect your rights, we need to make restrictions that forbid distributors to deny you these rights or to ask you to surrender these rights. These restrictions translate to certain responsibilities for you if you distribute copies of the library or if you modify it.

For example, if you distribute copies of the library, whether gratis or for a fee, you must give the recipients all the rights that we gave you. You must make sure that they, too, receive or can get the source code. If you link other code with the library, you must provide complete object files to the recipients, so that they can relink them with the library after making changes to the library and recompiling it. And you must show them these terms so they know their rights.

We protect your rights with a two-step method: (1) we copyright the library, and (2) we offer you this license, which gives you legal permission to copy, distribute and/or modify the library.

To protect each distributor, we want to make it very clear that there is no warranty for the free library. Also, if the library is modified by someone else and passed on, the recipients should know that what they have is not the original version, so that the original author's reputation will not be affected by problems that might be introduced by others.

Finally, software patents pose a constant threat to the existence of any free program. We wish to make sure that a company cannot effectively restrict the users of a free program by obtaining a restrictive license from a patent holder. Therefore, we insist that any patent license obtained for a version of the library must be consistent with the full freedom of use specified in this license.

Most GNU software, including some libraries, is covered by the ordinary GNU General Public License. This license, the GNU Lesser General Public License, applies to certain designated libraries, and is quite different from the ordinary General Public License. We use this license for certain libraries in order to permit linking those libraries into non-free programs.

When a program is linked with a library, whether statically or using a shared library, the combination of the two is legally speaking a combined work, a derivative of the original library. The ordinary General Public License therefore permits such linking only if the entire combination fits its criteria of freedom. The Lesser General Public License permits more lax criteria for linking other code with the library.

We call this license the "Lesser" General Public License because it does less to protect the user's freedom than the ordinary General Public License. It also provides other free software developers less of an advantage over competing non-free programs. These disadvantages are the reason we use the ordinary General Public License for many libraries. However, the Lesser license provides advantages in certain special circumstances.

For example, on rare occasions, there may be a special need to encourage the widest possible use of a certain library, so that it becomes a de-facto standard. To achieve this, non-free programs must be allowed to use the library. A more frequent case is that a free library does the same job as widely used non-free libraries. In this case, there is little to gain by limiting the free library to free software only, so we use the Lesser General Public License.

In other cases, permission to use a particular library in non-free programs enables a greater number of people to use a large body of free software. For example, permission to use the GNU C Library in non-free programs enables many more people to use the whole GNU operating system, as well as its variant, the GNU/Linux operating system.

Although the Lesser General Public License is Less protective of the users' freedom, it does ensure that the user of a program that is linked with the Library has the freedom and the wherewithal to run that program using a modified version of the Library.

The precise terms and conditions for copying, distribution and modification follow. Pay close attention to the difference between a "work based on the library" and a "work that uses the library". The former contains code derived from the library, whereas the latter must be combined with the library in order to run.

GNU LESSER GENERAL PUBLIC LICENSE TERMS AND CONDITIONS FOR COPYING, DISTRIBUTION AND MODIFICATION

0. This license agreement applies to any software library or other program which contains a notice placed by the copyright holder or other authorized party saying it may be distributed under the terms of this Lesser General Public License (also called "this license"). Each license is addressed as "you".

A "library" means a collection of software functions and/or data prepared so as to be conveniently linked with application programs (which use some of those functions and data) to form executables.

The "Library", below, refers to any such software library or work which has been distributed under these terms. A "work based on the Library" means either the Library or any derivative work under copyright law: that is to say, a work containing the library or a portion of it, either verbatim or with modifications and/or translated straightforwardly into another language. (Hereinafter, translation is included without limitation in the term "modification".)

"Source code" for a work means the preferred form of the work for making modifications to it. For a library, complete source code means all the source code for all modules it contains, plus any associated interface definition files, plus the scripts used to control compilation and installation of the library.

Activities other than copying, distribution and modification are not covered by this license; they are outside its scope. The act of running a program using the Library is not restricted, and output from such a program is covered only if its contents constitute a work based on the library (independent of the use of the Library in a tool for writing it). Whether that is true depends on what the library does and what the program that uses the library does.

1. You may copy and distribute verbatim copies of the library's complete source code as you receive it, in any medium, provided that you conspicuously and appropriately publish on

each copy an appropriate copyright notice and disclaimer of warranty; keep intact all the notices that refer to this license and to the absence of any warranty; and distribute a copy of this license along with the Library.

You may charge a fee for the physical act of transferring a copy, and you may at your option offer warranty protection in exchange for a fee.

2. You may modify your copy or copies of the Library or any portion of it, thus forming a work based on the Library, and copy and distribute such modifications or work under the terms of section 1 above, provided that you also meet all of these conditions:

- a) The modified work must itself be a software library.
- b) You must cause the files modified to carry prominent notices stating that you changed the files and the date of any change.
- c) You must cause the whole of the work to be licensed at no charge to all third parties under the terms of this license.
- d) If a facility in the modified Library refers to a function or a table of data to be supplied by an application program that uses the facility, other than as an argument passed when the facility is invoked, then you must make a good faith effort to ensure that, in the event an application does not supply such function or table, the facility still operates, and performs whatever part of its purpose remains meaningful.

(For example, a function in a library to compute square roots has a purpose that is entirely well-defined independent of the application. Therefore, Subsection 2d requires that any application-supplied function or table used by this function must be optional: if the application does not supply it, the square root function must still compute square roots.)

These requirements apply to the modified work as a whole. If identifiable sections of that work are not derived from the library, and can be reasonably considered independent and separate works in themselves, then this license, and its terms, do not apply to those sections when you distribute them as separate works. But when you distribute the same sections as part of a whole which is a work based on the library, the distribution of the whole must be on the terms of this license, whose permissions for other licenses extend to the entire whole, and thus to each and every part regardless of who wrote it.

Thus, it is not the intent of this section to claim rights or contest your rights to work written entirely by you; rather, the intent is to exercise the right to control the distribution of derivative or collective works based on the library.

In addition, mere aggregation of another work not based on the library with the library (or with a work based on the library) on a volume of a storage or distribution medium does not bring the other work under the scope of this license.

3. You may opt to apply the terms of the ordinary GNU General Public License instead of this License to a given copy of the Library. To do this, you must alter all the notices that refer to this License, so that they refer to the ordinary GNU General Public License, version 2, instead of to this License. (If a newer version than version 2 of the ordinary GNU General Public License has appeared, then you can specify that version instead if you wish.) Do not make any other change in these notices.

Once this change is made in a given copy, it is irreversible for that copy, so the ordinary GNU General Public License applies to all subsequent copies and derivative works made from that copy.

This option is useful when you wish to copy part of the code of the library into a program that is not a library.

4. You may copy and distribute the library (or a portion or derivative of it, under Section 2) in object code or executable form under the terms of Sections 1 and 2 above provided that you accompany it with the complete corresponding machine-readable source code, which must be distributed under the terms of sections 1 and 2 above on a medium customarily used for software interchange.

If distribution of object code is made by offering access to copy from a designated place, then offering equivalent access to copy the source code from the same place satisfies the requirement to distribute the source code, even though third parties are not compelled to copy the source along with the object code.

5. A program that contains no derivative of any portion of the Library, but is designed to work with the Library by being compiled or linked with it, is called a “work that uses the Library”. Such a work, in isolation, is not a derivative work of the Library, and therefore falls outside the scope of this license.

However, linking a “work that uses the library” with the Library creates an executable that is a derivative of the Library (because it contains portions of the library), rather than a “work that uses the library”. The executable is therefore covered by this license. Section 6 states terms for distribution of such executable.

When a “work that uses the library” uses material from a header file that is part of the library, the object code for the work may be a derivative work of the library even though the source code is not.

Whether this is true is especially significant if the work can be linked without the library, or if the work is itself a library. The threshold for this to be true is not precisely defined by law.

If such an object file uses only numerical parameters, data structure layouts and accessories, and small macros and small inline functions (ten lines or less in length), then the use of

the object file is unrestricted, regardless of whether it is legally a derivative work. (Executable containing this object code plus portions of the library will still fall under Section 6.)

Otherwise, if the work is a derivative of the library, you may distribute the object code for the work under the terms of Section 6. Any executable containing that work also fall under Section 6, whether or not they are linked directly with the library itself.

6. As an exception to the sections above, you may also combine or link a “work that uses the library” with the library to produce a work containing portions of the library, and distribute that work under terms of your choice, provided that the terms permit modification of the work for the customer’s own use and reverse engineering for debugging such modifications.

You must give prominent notice with each copy of the work that the library is used in it and that the Library and its use are covered by this license. You must supply a copy of this license. If the work during execution displays copyright notices, you must include the copyright notice for the library among them, as well as a reference directing the user to the copy of this license. Also, you must do one of these things:

- a) Accompany the work with the complete corresponding machine-readable source code for the library including whatever changes were used in the work (which must be distributed under Sections 1 and 2 above); and, if the work is an executable linked with the Library, with the complete machine-readable “work that uses the Library”, as object code and/or source code, so that the user can modify the library and then relink to produce a modified executable containing the modified library. (It is understood that the user who changes the contents of definitions files in the library will not necessarily be able to recompile the application to use the modified definitions.)
- b) Use a suitable shared library mechanism for linking with the library. A suitable mechanism is one that (1) uses at run time a copy of the library already present on the user’s computer system, rather than copying library functions into the executable, and (2) will operate properly with a modified version of the library, if the user installs one, as long as the modified version is interface-compatible with the version that the work was made with.
- c) Accompany the work with a written offer, valid for at least three years, to give the same user the materials specified in Subsection 6, above, for a charge no more than the cost of performing this distribution.
- d) If distribution of the work is made by offering access to copy from a designated place, offer equivalent access to copy the above specified materials from the same place.
- e) Verify that the user has already received a copy of these materials or that you have already sent this user a copy.

For an executable, the required form of the “work that uses the library” must include any data and utility programs needed for reproducing the executable from it. However, as a special exception, the materials to be distributed need not include anything that is normally distributed (in either source or binary form) with the major components (compiler, kernel, and so on) of the operating system on which the executable runs, unless that component itself accompanies the executable.

It may happen that this requirement contradicts the license restrictions of other proprietary libraries that do not normally accompany the operating system. Such a contradiction means you cannot use both them and the library together in an executable that you distribute.

7. You may place library facilities that are a work based on the library side-by-side in a single library together with other library facilities not covered by this license, and distribute such a combined library, provided that the separate distribution of the work based on the Library and of the other library facilities is otherwise permitted, and provided that you do these two things:
 - a) Accompany the combined library with a copy of the same work based on the Library, uncombined with any other library facilities. This must be distributed under the terms of the sections above.
 - b) Give prominent notice with the combined library of the fact that part of it is a work based on the library, and explaining where to find the accompanying uncombined form of the same work.
8. You may not copy, modify, sublicense, link with, or distribute the library except as expressly provided under this license. Any attempt otherwise to copy, modify, sublicense, link with, or distribute the library is void, and will automatically terminate your rights under this license. However, parties who have received copies, or rights, from you under this license will not have their licenses terminated so long as such parties remain in full compliance.
9. You are not required to accept this license, since you have not signed it. However, nothing else grants you permission to modify or distribute the library or its derivative works. These actions are prohibited by law if you do not accept this license. Therefore, by modifying or distributing the library (or any work based on the library), you indicate your acceptance of this license to do so, and all its terms and conditions for copying, distributing or modifying the library or works based on it.
10. Each time you redistribute the library (or any work based on the Library), the recipient automatically receives a license from the original licensor to copy, distribute, link with or modify the library subject to these terms and conditions. You may not impose any further restrictions on the recipients’ exercise

of the rights granted herein.

You are not responsible for enforcing compliance by third parties with this license.

11. If, as a consequence of a court judgment or allegation of patent infringement or for any other reason (not limited to patent issues), conditions are imposed on you (whether by court order, agreement or otherwise) that contradict the conditions of this license, they do not excuse you from the conditions of this license. If you cannot distribute so as to satisfy simultaneously your obligations under this license and any other pertinent obligations, then as a consequence you may not distribute the library at all. For example, if a patent license would not permit royalty-free redistribution of the library by all those who receive copies directly or indirectly through you, then the only way you could satisfy both it and this license would be to refrain entirely from distribution of the library.

If any portion of this section is held invalid or unenforceable under any particular circumstance, the balance of the section is intended to apply, and the section as a whole is intended to apply in other circumstances.

It is not the purpose of this section to induce you to infringe any patents or other property right claims or to contest validity of any such claims; this section has the sole purpose of protecting the integrity of the free software distribution system which is implemented by public license practices. Many people have made generous contributions to the wide range of software distributed through that system in reliance on consistent application of that system; it is up to the author/donor to decide if he or she is willing to distribute software through any other system and a license cannot impose that choice.

This section is intended to make thoroughly clear what is believed to be a consequence of the rest of this license.

12. If the distribution and/or use of the library is restricted in certain countries either by patents or by copyrighted interfaces, the original copyright holder who places the library under this license may add an explicit geographical distribution limitation excluding those countries, so that distribution is permitted only in or among countries not thus excluded. In such case, this license incorporates the limitation as if written in the body of this license.
13. The Free Software Foundation may publish revised and/or new versions of the Lesser General Public License from time to time. Such new versions will be similar in spirit to the present version, but may differ in detail to address new problems or concerns. Each version is given a distinguishing version number. If the library specifies a version number of this license which applies to it and “any later version”, you have the option of following the terms and conditions either of that version or of any later version published by the Free Software Foundation.

APPENDIX

If the library does not specify a license version number, you may choose any version ever published by the Free Software Foundation.

14. If you wish to incorporate parts of the library into other free programs whose distribution conditions are incompatible with these, write to the author to ask for permission. For software which is copyrighted by the Free Software Foundation, write to the Free Software Foundation; we sometimes make exceptions for this. Our decision will be guided by the two goals of preserving the free status of all derivatives of our free software and of promoting the sharing and reuse of software generally.

NO WARRANTY

15. BECAUSE THE LIBRARY IS LICENSED FREE OF CHARGE, THERE IS NO WARRANTY FOR THE LIBRARY, TO THE EXTENT PERMITTED BY APPLICABLE LAW. EXCEPT WHEN OTHERWISE STATED IN WRITING THE COPYRIGHT HOLDERS AND/OR OTHER PARTIES PROVIDE THE LIBRARY "AS IS" WITHOUT WARRANTY OF ANY KIND, EITHER EXPRESSED OR IMPLIED, INCLUDING, BUT NOT LIMITED TO, THE IMPLIED WARRANTIES OF MERCHANTABILITY AND FITNESS FOR A PARTICULAR PURPOSE. THE ENTIRE RISK AS TO THE QUALITY AND PERFORMANCE OF THE LIBRARY IS WITH YOU. SHOULD THE LIBRARY PROVE DEFECTIVE, YOU ASSUME THE COST OF ALL NECESSARY SERVICING, REPAIR OR CORRECTION.

16. IN NO EVENT UNLESS REQUIRED BY APPLICABLE LAW OR AGREED TO IN WRITING WILL ANY COPYRIGHT HOLDER, OR ANY OTHER PARTY WHO MAY MODIFY AND/OR REDISTRIBUTE THE LIBRARY AS PERMITTED ABOVE, BE LIABLE TO YOU FOR DAMAGES, INCLUDING ANY GENERAL, SPECIAL, INCIDENTAL OR CONSEQUENTIAL DAMAGES ARISING OUT OF THE USE OR INABILITY TO USE THE LIBRARY (INCLUDING BUT NOT LIMITED TO LOSS OF DATA OR DATA BEING RENDERED INACCURATE OR LOSSES SUSTAINED BY YOU OR THIRD PARTIES OR A FAILURE OF THE LIBRARY TO OPERATE WITH ANY OTHER SOFTWARE), EVEN IF SUCH HOLDER OR OTHER PARTY HAS BEEN ADVISED OF THE POSSIBILITY OF SUCH DAMAGES.

END OF TERMS AND CONDITIONS

How to apply these terms to your new libraries

If you develop a new library, and you want it to be of the greatest possible use to the public, we recommend making it free software that everyone can redistribute and change. You can do so by permitting redistribution under these terms (or, alternatively, under the terms of the ordinary General Public License).

To apply these terms, attach the following notices to the library. It is safest to attach them to the start of each source file to most effectively convey the exclusion of warranty; and each file should have at least the "copyright" line and a pointer to where the full notice is found.

one line to give the library's name and a brief idea of what it does.
Copyright (C) <year> <name of author>

This library is free software; you can redistribute it and/or modify it under the terms of the GNU Lesser General Public License as published by the Free Software Foundation; either version 2.1 of the license, or (at your option) any later version.

This library is distributed in the hope that it will be useful, but WITHOUT ANY WARRANTY; without even the implied warranty of MERCHANTABILITY or FITNESS FOR A PARTICULAR PURPOSE. See the GNU Lesser General Public License for more details.

You should have received a copy of the GNU Lesser General Public License along with this library; if not, write to the Free Software Foundation, Inc., 51 Franklin Street, Fifth Floor, Boston, MA 02110-1301 USA

Also add information on how to contact you by electronic and paper mail.

You should also get your employer (if you work as a programmer) or your school, if any, to sign a "copyright disclaimer" for the library, if necessary. Here is a sample; alter the names:

Yoyodyne, Inc., hereby disclaims all copyright interest in the library 'Frob' (a library for tweaking knobs) written by James Random Hacker.

signature of Ty Coon, 1 April 1990
Ty Coon, President of Vice

MOZILLA PUBLIC LICENSE

Version 1.1

1. Definitions.

1.0.1. “Commercial use” means distribution or otherwise making the covered code available to a third party.

1.1. “Contributor” means each entity that creates or contributes to the creation of modifications.

1.2. “Contributor version” means the combination of the original code, prior modifications used by a contributor, and the modifications made by that particular contributor.

1.3. “Covered code” means the original code or modifications or the combination of the original code and modifications, in each case including portions thereof.

1.4. “Electronic distribution mechanism” means a mechanism generally accepted in the software development community for the electronic transfer of data.

1.5. “Executable” means covered code in any form other than source code.

1.6. “Initial developer” means the individual or entity identified as the initial Developer in the Source Code notice required by exhibit A.

1.7. “Larger work” means a work which combines covered code or portions thereof with code not governed by the terms of this License.

1.8. “License” means this document.

1.8.1. “Licensable” means having the right to grant, to the maximum extent possible, whether at the time of the initial grant or subsequently acquired, any and all of the rights conveyed herein.

1.9. “Modifications” means any addition to or deletion from the substance or structure of either the original code or any previous modifications. When covered code is released as a series of files, a modification is:

A. Any addition to or deletion from the contents of a file containing original code or previous modifications.

B. Any new file that contains any part of the original code or previous modifications.

1.10. “Original code” means source code of computer software

code which is described in the source code notice required by exhibit as original code, and which, at the time of its release under this license is not already covered code governed by this license.

1.10.1. “Patent claims” means any patent claim(s), now owned or hereafter acquired, including without limitation, method, process, and apparatus claims, in any patent licensable by grantor.

1.11. “Source code” means the preferred form of the covered code for making modifications to it, including all modules it contains, plus any associated interface definition files, scripts used to control compilation and installation of an executable, or source code differential comparisons against either the original code or another well known, available covered code of the contributor’s choice. The source code can be in a compressed or archival form, provided the appropriate decompression or de-archiving software is widely available for no charge.

1.12. “You” (or “Your”) means an individual or a legal entity exercising rights under, and complying with all of the terms of, this license or a future version of this license issued under section 6.1.

For legal entities, “You” includes any entity which controls, is controlled by, or is under common control with You. For purposes of this definition, “control” means (a) the power, direct or indirect, to cause the direction or management of such entity, whether by contract or otherwise, or (b) ownership of more than fifty percent (50%) of the outstanding shares or beneficial ownership of such entity.

2. Source Code License.

2.1. The initial developer grant.
The initial developer hereby grants You a world-wide, royalty-free, non-exclusive license, subject to third party intellectual property claims:

- a) under intellectual property rights (other than patent or trademark) licensable by initial developer to use, reproduce, modify, display, perform, sublicense and distribute the original code (or portions thereof) with or without modifications, and/or as part of a larger work; and
- (b) under patents claims infringed by the making, using or selling of original code, to make, have made, use, practice, sell, and offer for sale, and/or otherwise dispose of the original code (or portions thereof).

- (c) the licenses granted in this section 2.1 (a) and (b) are effective on the date Initial developer first distributes original code under the terms of this license.
- (d) Notwithstanding section 2.1 (b) above, no patent license is granted: 1) for code that You delete from the original Code; 2) separate from the original code; or 3) for infringements caused by: i) the modification of the original code or ii) the combination of the original code with other software or devices.

2.2. Contributor Grant.

Subject to third party intellectual property claims, each contributor hereby grants You a world-wide, royalty-free, non-exclusive license

- (a) under intellectual property rights (other than patent or trademark) licensable by contributor, to use, reproduce, modify, display, perform, sublicense and distribute the modifications created by such contributor (or portions thereof) either on an unmodified basis, with other modifications, as covered code and/or as part of a larger work; and
- (b) under patent claims infringed by the making, using, or selling of modifications made by that contributor either alone and/or in combination with its contributor version (or portions of such combination), to make, use, sell, offer for sale, have made, and/or otherwise dispose of: 1) modifications made by that contributor (or portions thereof); and 2) the combination of modifications made by that contributor with its contributor version (or portions of such combination).
- (c) the licenses granted in sections 2.2 (a) and 2.2 (b) are effective on the date contributor first makes commercial use of the covered code.
- (d) Notwithstanding section 2.2 (b) above, no patent license is granted: 1) for any code that contributor has deleted from the contributor version; 2) separate from the contributor version; 3) for infringements caused by: i) third party modifications of contributor version or ii) the combination of modifications made by that contributor with other software (except as part of the contributor version) or other devices; or 4) under patent claims infringed by covered code in the absence of modifications made by that contributor.

3. Distribution Obligations.

3.1. Application of license.

The modifications which You create or to which you contribute are governed by the terms of this license, including without limitation section 2.2. The source code version of covered code may be distributed only under the terms of this license or a future version of this license released under section 6.1, and you must include a copy of this license with every copy of the source code you distribute.

You may not offer or impose any terms on any source code version that alters or restricts the applicable version of this license or the recipients' rights hereunder. However, you may include an additional document offering the additional rights described in section 3.5.

3.2. Availability of source code.

Any modification which you create or to which you contribute must be made available in source code form under the terms of this license either on the same media as an executable version or via an accepted electronic distribution mechanism to anyone to whom you made an executable version available; and if made available via electronic distribution mechanism, must remain available for at least twelve (12) months after the date it initially became available, or at least six (6) months after a subsequent version of that particular modification has been made available to such recipients. You are responsible for ensuring that the source code version remains available even if the electronic distribution mechanism is maintained by a third party.

3.3. Description of modifications.

You must cause all covered code to which you contribute to contain a file documenting the changes You made to create that covered code and the date of any change. You must include a prominent statement that the modification is derived, directly or indirectly, from original code provided by the initial developer and including the name of the initial developer in (a) the source code, and (b) in any notice in an executable version or related documentation in which you describe the origin or ownership of the covered code.

3.4. Intellectual property matters

(a) Third party claims.

If contributor has knowledge that a license under a third party's intellectual property rights is required to exercise the rights granted by such contributor under sections 2.1 or 2.2, contributor must include a text file with the source code distribution titled "LEGAL" which describes the claim and the party making the claim in sufficient detail that a recipient will know whom to contact. If contributor obtains such knowledge after the modification is made available as described in section 3.2, contributor shall promptly modify the LEGAL file in all copies contributor makes available thereafter and shall take other steps (such as notifying appropriate mailing lists or newsgroups) reasonably calculated to inform those who received the covered code that new knowledge has been obtained.

(b) Contributor APIs.

If contributor's modifications include an application programming interface and contributor has knowledge of patent licenses which are reasonably necessary to implement that API, contributor must also include this information in the LEGAL file.

(c) Representations.

contributor represents that, except as disclosed pursuant to section 3.4(a) above, contributor believes that contributor's modifications are contributor's original creation(s) and/or contributor has sufficient rights to grant the rights conveyed by this license.

3.5. Required notices.

You must duplicate the notice in exhibit A in each file of the source code. If it is not possible to put such notice in a particular source code file due to its structure, then You must include such notice in a location (such as a relevant directory) where a user would be likely to look for such a notice. If You created one or more modification(s), you may add your name as a contributor to the notice described in exhibit A. you must also duplicate this license in any documentation for the source code where You describe recipients' rights or ownership rights relating to covered code. You may choose to offer, and to charge a fee for, warranty, support, indemnity or liability obligations to one or more recipients of covered code. However, you may do so only on your own behalf, and not on behalf of the Initial developer or any contributor. You must make it absolutely clear than any such warranty, support, indemnity or liability obligation is offered by you alone, and You hereby agree to indemnify the Initial developer and every contributor for any liability incurred by the Initial developer or such contributor as a result of warranty, support, indemnity or liability terms you offer.

3.6. Distribution of executable versions.

You may distribute covered code in executable form only if the requirements of section 3.1-3.5 have been met for that covered code, and if you include a notice stating that the source code version of the covered code is available under the terms of this license, including a description of how and where you have fulfilled the obligations of section 3.2. The notice must be conspicuously included in any notice in an executable version, related documentation or collateral in which you describe recipients' rights relating to the covered code. You may distribute the executable version of covered code or ownership rights under a license of your choice, which may contain terms different from this license, provided that you are in compliance with the terms of this license and that the license for the executable version does not attempt to limit or alter the recipient's rights in the source code version from the rights set forth in this license. If you distribute the executable version under a different license you must make it absolutely clear that any terms which differ from this license are offered by you alone, not by the Initial developer or any contributor. You hereby agree to indemnify the initial developer and every contributor for any liability incurred by the initial developer or such contributor as a result of any such terms You offer.

3.7. Larger works.

You may create a larger work by combining covered code with other code not governed by the terms of this license and distribute the larger work as a single product. In such a case, you must make sure the requirements of this license are fulfilled for the covered code.

4. Inability to comply due to statute or regulation.

If it is impossible for you to comply with any of the terms of this license with respect to some or all of the covered code due to statute, judicial order, or regulation then you must: (a) comply with the terms of this license to the maximum extent possible; and (b) describe the limitations and the code they affect. Such description must be included in the LEGAL file described in section 3.4 and must be included with all distributions of the source code. Except to the extent prohibited by statute or regulation, such description must be sufficiently detailed for a recipient of ordinary skill to be able to understand it.

5. Application of this license.

This license applies to code to which the initial developer has attached the notice in exhibit A and to related covered code.

6. Versions of the license.

6.1. New versions.

Netscape communications corporation ("Netscape") may publish revised and/or new versions of the license from time to time. Each version will be given a distinguishing version number.

6.2. Effect of new versions.

Once covered code has been published under a particular version of the license, you may always continue to use it under the terms of that version. You may also choose to use such covered code under the terms of any subsequent version of the license published by netscape. No one other than netscape has the right to modify the terms applicable to covered code created under this license.

6.3. Derivative works.

If You create or use a modified version of this license (which you may only do in order to apply it to code which is not already covered code governed by this license), You must (a) rename Your license so that the phrases "Mozilla", "MOZILLAPL", "MOZPL", "Netscape", "MPL", "NPL" or any confusingly similar phrase do not appear in your license (except to note that your license differs from this license) and (b) otherwise make it clear that Your version of the license contains terms which differ from the Mozilla Public license and netscape Public License. (Filling in the name of the initial developer, original code or contributor in the notice described in exhibit A shall not of themselves be deemed to be modifications of this license.)

7. DISCLAIMER OF WARRANTY.

COVERED CODE IS PROVIDED UNDER THIS LICENSE ON AN "AS IS" BASIS, WITHOUT WARRANTY OF ANY KIND, EITHER EXPRESSED OR IMPLIED, INCLUDING, WITHOUT LIMITATION, WARRANTIES THAT THE COVERED CODE IS FREE OF DEFECTS, MERCHANTABILITY, FIT FOR A PARTICULAR PURPOSE OR NON-INFRINGEMENT. THE ENTIRE RISK AS TO THE QUALITY AND PERFORMANCE OF THE COVERED CODE IS WITH YOU. SHOULD ANY COVERED CODE PROVE DEFECTIVE IN ANY RESPECT, YOU (NOT THE INITIAL DEVELOPER OR ANY OTHER CONTRIBUTOR) ASSUME THE COST OF ANY NECESSARY SERVICING, REPAIR OR CORRECTION. THIS DISCLAIMER OF WARRANTY CONSTITUTES AN ESSENTIAL PART OF THIS LICENSE. NO USE OF ANY COVERED CODE IS AUTHORIZED HEREUNDER EXCEPT UNDER THIS DISCLAIMER.

8. TERMINATION.

8.1. This license and the rights granted hereunder will terminate automatically if you fail to comply with terms herein and fail to cure such breach within 30 days of becoming aware of the breach. All sublicenses to the covered code which are properly granted shall survive any termination of this license. Provisions which, by their nature, must remain in effect beyond the termination of this license shall survive.

8.2. If you initiate litigation by asserting a patent infringement claim (excluding declaratory judgment actions) against initial developer or a contributor (the initial developer or contributor against whom you file such action is referred to as "Participant") alleging that:

- (a) such participant's contributor version directly or indirectly infringes any patent, then any and all rights granted by such participant to you under sections 2.1 and/or 2.2 of this license shall, upon 60 days notice from Participant terminate prospectively, unless if within 60 days after receipt of notice you either: (i) agree in writing to pay participant a mutually agreeable reasonable royalty for your past and future use of modifications made by such participant, or (ii) withdraw your litigation claim with respect to the contributor version against such participant. If within 60 days of notice, a reasonable royalty and payment arrangement are not mutually agreed upon in writing by the parties or the litigation claim is not withdrawn, the rights granted by participant to you under sections 2.1 and/or 2.2 automatically terminate at the expiration of the 60 day notice period specified above.
- (b) any software, hardware, or device, other than such participant's contributor Version, directly or indirectly infringes any patent, then any rights granted to You by

such participant under sections 2.1 (b) and 2.2(b) are revoked effective as of the date you first made, used, sold, distributed, or had made, modifications made by that participant.

8.3. If you assert a patent infringement claim against participant alleging that such participant's contributor version directly or indirectly infringes any patent where such claim is resolved (such as by license or settlement) prior to the initiation of patent infringement litigation, then the reasonable value of the licenses granted by such participant under sections 2.1 or 2.2 shall be taken into account in determining the amount or value of any payment or license.

8.4. In the event of termination under sections 8.1 or 8.2 above, all end user license agreements (excluding distributors and resellers) which have been validly granted by you or any distributor hereunder prior to termination shall survive termination.

9. LIMITATION OF LIABILITY.

UNDER NO CIRCUMSTANCES AND UNDER NO LEGAL THEORY, WHETHER TORT (INCLUDING NEGLIGENCE), CONTRACT, OR OTHERWISE, SHALL YOU, THE INITIAL DEVELOPER, ANY OTHER CONTRIBUTOR, OR ANY DISTRIBUTOR OF COVERED CODE, OR ANY SUPPLIER OF ANY OF SUCH PARTIES, BE LIABLE TO ANY PERSON FOR ANY INDIRECT, SPECIAL, INCIDENTAL, OR CONSEQUENTIAL DAMAGES OF ANY CHARACTER INCLUDING, WITHOUT LIMITATION, DAMAGES FOR LOSS OF GOODWILL, WORK STOPPAGE, COMPUTER FAILURE OR MALFUNCTION, OR ANY AND ALL OTHER COMMERCIAL DAMAGES OR LOSSES, EVEN IF SUCH PARTY SHALL HAVE BEEN INFORMED OF THE POSSIBILITY OF SUCH DAMAGES. THIS LIMITATION OF LIABILITY SHALL NOT APPLY TO LIABILITY FOR DEATH OR PERSONAL INJURY RESULTING FROM SUCH PARTY'S NEGLIGENCE TO THE EXTENT APPLICABLE LAW PROHIBITS SUCH LIMITATION. SOME JURISDICTIONS DO NOT ALLOW THE EXCLUSION OR LIMITATION OF INCIDENTAL OR CONSEQUENTIAL DAMAGES, SO THIS EXCLUSION AND LIMITATION MAY NOT APPLY TO YOU.

10. U.S. GOVERNMENT END USERS.

The covered code is a "commercial item," as that term is defined in 48 C.F.R. 2.101 (Oct. 1995), consisting of "commercial computer software" and "commercial computer software documentation," as such terms are used in 48 C.F.R. 12.212 (Sept. 1995). Consistent with 48 C.F.R. 12.212 and 48 C.F.R. 227.7202-1 through 227.7202-4 (June 1995), all U.S. Government end users acquire covered code with only those rights set forth herein.

11. MISCELLANEOUS.

This license represents the complete agreement concerning subject matter hereof. If any provision of this license is held to be unenforceable, such provision shall be reformed only to the extent necessary to make it enforceable. This License shall be governed by California law provisions (except to the extent applicable law, if any, provides otherwise), excluding its conflict-of-law provisions. With respect to disputes in which at least one party is a citizen of, or an entity chartered or registered to do business in the united states of america, any litigation relating to this License shall be subject to the jurisdiction of the federal courts of the northern district of california, with venue lying in santa clara county, california, with the losing party responsible for costs, including without limitation, court costs and reasonable attorneys' fees and expenses. The application of the united nations convention on contracts for the International sale of goods is expressly excluded. Any law or regulation which provides that the language of a contract shall be construed against the drafter shall not apply to this license.

12. RESPONSIBILITY FOR CLAIMS.

As between initial developer and the contributors, each party is responsible for claims and damages arising, directly or indirectly, out of its utilization of rights under this license and you agree to work with initial developer and contributors to distribute such responsibility on an equitable basis. Nothing herein is intended or shall be deemed to constitute any admission of liability.

13. MULTIPLE-LICENSED CODE.

Initial developer may designate portions of the covered code as "Multiple-Licensed". "Multiple-Licensed" means that the initial developer permits you to utilize portions of the covered code under your choice of the NPL or the alternative licenses, if any, specified by the initial developer in the file described in exhibit A.

EXHIBIT A -Mozilla Public License.

The contents of this file are subject to the Mozilla Public License Version 1.1 (the "license"); you may not use this file except in compliance with the License. You may obtain a copy of the license at <http://www.mozilla.org/MPL/>

Software distributed under the license is distributed on an "AS IS" basis, WITHOUT WARRANTY OF ANY KIND, either express or implied. See the license for the specific language governing rights and limitations under the License.

The Original Code is _____.

The Initial Developer of the Original Code is _____.

Portions created by _____ are Copyright (C) _____. All Rights Reserved.

Contributor(s): _____.

Alternatively, the contents of this file may be used under the terms of the ____ license (the "[] License"), in which case the provisions of [] license are applicable instead of those above. If you wish to allow use of your version of this file only under the terms of the [] license and not to allow others to use your version of this file under the MPL, indicate your decision by deleting the provisions above and replace them with the notice and other provisions required by the [] license. If you do not delete the provisions above, a recipient may use your version of this file under either the MPL or the [] license."

NOTE: The text of this exhibit A may differ slightly from the text of the notices in the source code files of the original code. You should use the text of this exhibit A rather than the text found in the original code/source code for Your modifications.

LG Electronics Inc.