

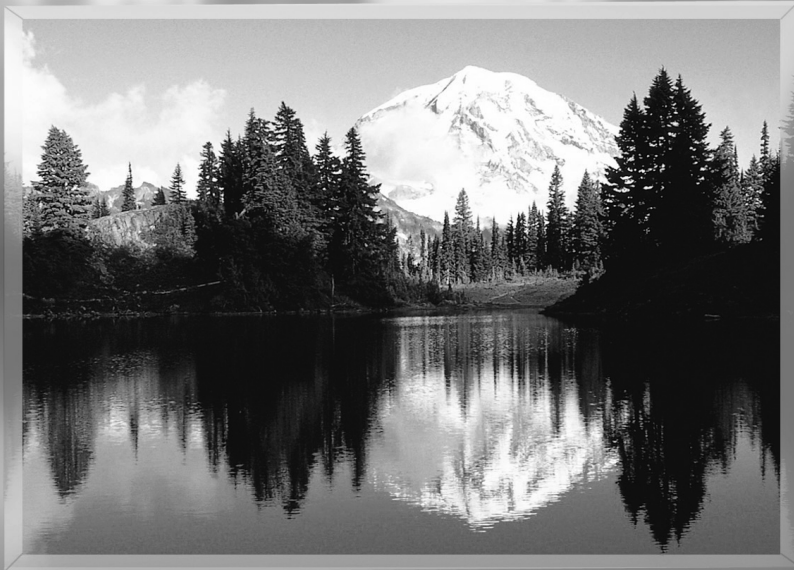

SAMSUNG **PLASMA DISPLAY**

Owner's Instructions
HP-R6372



This device is a Class B digital apparatus.

Register your product at www.samsung.com/global/register

Important Warranty Information Regarding Television Format Viewing

Wide screen format PDP Displays (16:9, the aspect ratio of the screen width to height) are primarily designed to view wide screen format full-motion video. The images displayed on them should primarily be in the wide screen 16:9 ratio format, or expanded to fill the screen if your model offers this feature and the images are constantly moving. Displaying stationary graphics and images on screen, such as the dark side-bars on nonexpanded standard format television video and programming, should be limited to no more than 5% of the total television viewing per week.

Additionally, viewing other stationary images and text such as stock market reports, video game displays, station logos, web sites or computer graphics and patterns, should be limited as described above for all televisions. **Displaying stationary images that exceed the above guidelines can cause uneven aging of PDP Displays that leave subtle, but permanent burned-in ghost images in the PDP picture. To avoid this, vary the programming and images, and primarily display full screen moving images, not stationary patterns or dark bars.**

On PDP models that offer picture sizing features, use these controls to view different formats as a full screen picture.

Be careful in the selection and duration of television formats used for viewing. Uneven PDP aging as a result of format selection and use, as well as burned-in images, are not covered by your Samsung limited warranty.

U.S.A Only

The product unit accompanying this user manual is licensed under certain intellectual property rights of certain third parties. In particular, this product is licensed under the following US patents: 5,991,715, 5,740,317, 4,972,484, 5,214,678, 5,323,396, 5,539,829, 5,606,618, 5,530,655, 5,777,992, 6,289,308, 5,610,985, 5,481,643, 5,544,247, 5,960,037, 6,023,490, 5,878,080, and under US Published Patent Application No. 2001-44713-A1.

This license is limited to private non-commercial use by end-user consumers for licensed contents. No rights are granted for commercial use. The license does not cover any product unit other than this product unit and the license does not extend to any unlicensed product unit or process conforming to ISO/IEC 11172-3 or ISO/IEC 13818-3 used or sold in combination with this product unit. The license only covers the use of this product unit to encode and/or decode audio files conforming to the ISO/IEC 11172-3 or ISO/IEC 13818-3. No rights are granted under this license for product features or functions that do not conform to the ISO/IEC 11172-3 or ISO/IEC 13818-3.

Other countries

The product unit accompanying this user manual is licensed under certain intellectual property rights of certain third parties. This license is limited to private non-commercial use by end-user consumers for licensed contents. No rights are granted for commercial use. The license does not cover any product unit other than this product unit and the license does not extend to any unlicensed product unit or process conforming to ISO/IEC 11172-3 or ISO/IEC 13818-3 used or sold in combination with this product unit. The license only covers the use of this product unit to encode and/or decode audio files conforming to the ISO/IEC 11172-3 or ISO/IEC 13818-3. No rights are granted under this license for product features or functions that do not conform to the ISO/IEC 11172-3 or ISO/IEC 13818-3.

User Instructions

● Screen Image retention

Do not display a still image (such as on a video game) on the plasma display panel for more than several minutes as it can cause screen image retention. This image retention is also known as "screen burn". To avoid such image retention, refer to page 51 of this manual to reduce the degree of brightness and contrast of the screen when displaying a still image.

● Altitude

The PDP will not operate normally at altitudes above 6500 ft.

● Heat on the top of the PDP TV

The top side of the product may be hot after long periods of use as heat dissipates from the panel through the vent hole in the upper part of the product.

This is normal and does not indicate any defect or operation failure of the product.

However, children should be prevented from touching the upper part of the product.

● The product is making a 'cracking' noise.

A 'cracking' noise may occur when the product contracts or expands due to a change of surrounding environment such as temperature or humidity. This is normal and not a defect of the unit.

● Cell Defects

The PDP uses a panel consisting of 1,230,000(SD-level) to 3,150,000(HD-level) pixels which require sophisticated technology to produce. However, there may be few bright or dark pixels on the screen. These pixels will have no impact on the performance of the product.

● Avoid operating the TV at temperatures below 5°C (41°F)

● A still image displayed too long may cause permanent damage to the PDP Panel.

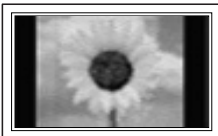

Watching the PDP TV in 4:3 format for a long period of time may leave traces of borders displayed on the left, right and center of the screen caused by the difference of light emission on the screen.

Playing a DVD or a game console may cause similar effect to the screen.

Damages caused by the above effect are not covered by the Warranty.

● Afterimage on the Screen.

Displaying still images from Video games and PC for longer than a certain period of time may produce partial afterimages.

To prevent this effect, reduce the 'brightness' and 'contrast' when displaying still images for a long time.

● Warranty

Warranty does not cover any damage caused by image retention.

Burn-in is not covered by the warranty.

Table of Contents

General Information

Your New Plasma Display Panel.....	8
Remote Control Buttons	11
Wall Installation Instructions	13
How to assemble the Stand-Base	17

Connections

Connecting VHF and UHF Antennas	20
Connecting Cable TV	21
Connecting a VCR	23
Connecting a Camcorder	24
Connecting a DVD Player (480i, 480p)	25
Connecting a DTV Receiver (480p, 720p, 1080i)	26
Connecting to HDMI (High Definition Multimedia Interface) (480p, 720p, 1080i) ..	27
Connecting a Digital TV Set-Top Box (480p, 720p, 1080i)	28
Connecting a Digital Audio System	29
Connecting to an Analog Amplifier	30
Connecting CableCARD	31

Operation

Turning the TV On and Off	34
Viewing the Menus and Displays	38
Memorizing the Channels	39
Adding and Erasing Channels	41
Setting Up Your Remote Control	44
Viewing an External Signal Source.....	46

Picture Control

Changing the Picture Standard	50
Customizing the Picture Settings	51
Viewing the DNIe Demonstration	53
Changing the Screen Size	54
Viewing the Picture-in-Picture	56
Selecting the Sound Source	62
Setting the My Color Control Mode.....	63

Sound Control

Customizing the Sound	68
Using Automatic Sound Settings	69
Setting the TruSurround XT.....	70
Choosing a Multi-Channel Sound (MTS) track - Digital	71
Choosing a Multi-Channel Sound (MTS) track - Analog	72
Using the Auto Volume	73
Choosing a Digital Sound Format.....	74
Setting the On/Off Melody	75
Selecting the Internal Mute	76

Channel Control

Selecting the Antenna	78
Selecting Your Favorite Channels	79
Labeling the Channels.....	80
Viewing the Channel Lists	81
Editing the Channel Lists	82
Fine Tuning Analog Channels	83
Checking the Digital-Signal Strength	84
LNA (Low Noise Amplifier)	85

Connecting a PC and Operation

Connecting a PC	88
Changing the Position of the Image	92
Picture Quality Adjustment.....	93
Image Reset	96

Time Setting

Setting the Clock	98
Setting the On/Off Timer.....	100
Setting the Sleep Timer	101

Function Description

Selecting a Menu Language	104
Digital Noise Reduction.....	105
Setting the Dynamic Contrast	106
Selecting the Film Mode	107
Setting the Blue Screen	108
Using the Color Weakness Enhancement Option	109
Viewing Closed Captions (On-Screen Text Messages) - Analog	110
Viewing Closed Captions (On-Screen Text Messages) - Digital.....	111
Menu Transparency Level	113
Using the Energy Saving Feature	114
Preventing Screen Burn-in	115
Reducing the Effects of Screen Burn	116
Setting the Function Help.....	117
Using the CableCARD.....	118
Using the V-Chip (for USA)	120
Using the V-Chip (for Canada)	126
Electronic Program Guide	134
Remind List	138

Appendix

Troubleshooting	142
Care and Maintenance	143
Specifications.....	144
Dimensions	145

Note

- The information contained in this User's Manual is subject to change without prior notice for improvement, and may vary depending on the version of the TV's software and the regional conditions.

S
A
M
S
U
N
G

P L A S M A D I S P L A Y P A N E L

General Information



Your New Plasma Display Panel	8
Remote Control Buttons	11
Wall Installation Instructions	13
How to assemble the Stand-Base.....	17



Your New Plasma Display Panel

Front Panel

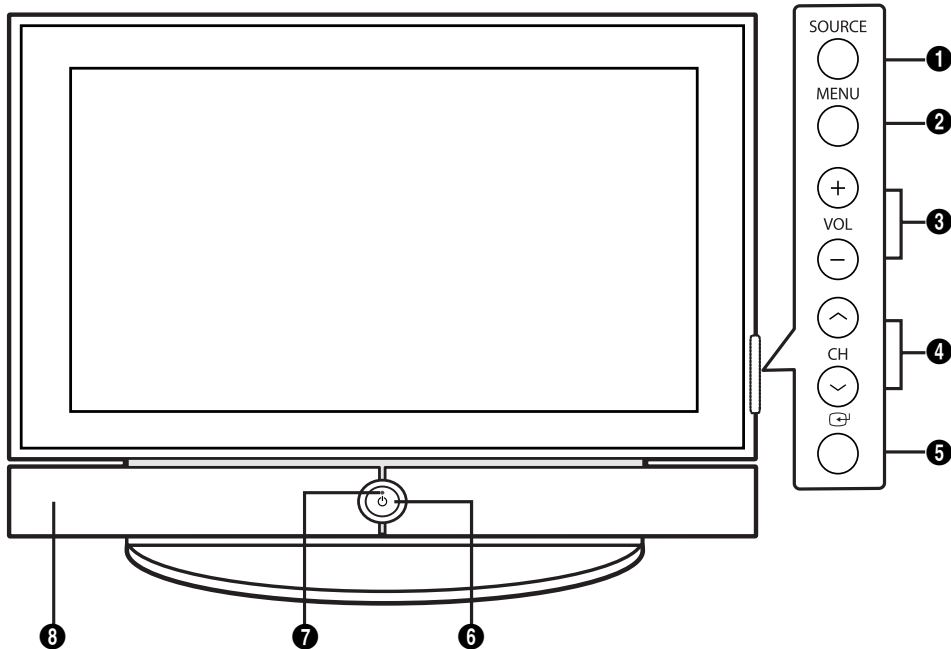

1 SOURCE button

Press to display all of the available video sources (TV, AV1, AV2, S-Video1, S-Video2, Component1, Component2, PC, and HDMI).

2 MENU button

Displays the main on-screen menu.

3 VOL +, - buttons

Press to increase or decrease the volume. Also used to select or adjust items on the on-screen menu.

4 CH(∧, ∨) buttons

Press CH∧ or CH∨ to change channels. Also used to move up or down in the on-screen menu.

5  (Enter) button

Press to confirm a selection.

6 Power button

Press to turn the TV on and off.

Power indicator
- Power Off : Blue
- Power On : Off

7 Remote Control Sensor

Aim the remote control towards this spot on the TV.

8 Speakers

Plasma Display

Side of the TV

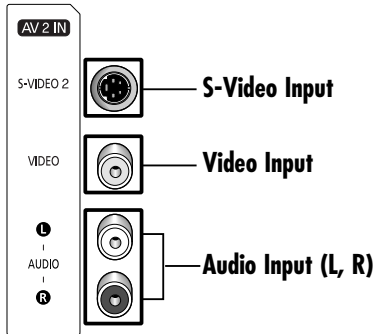

Ferrite Cores

The ferrite cores are used to shield the cables from interference.

When connecting a cable, open the ferrite core and clip it around the cable near the plug.

When more than one cable is to be connected, attach the ferrite core around the cables as shown below.

Side AV

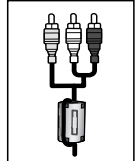

Power Cord

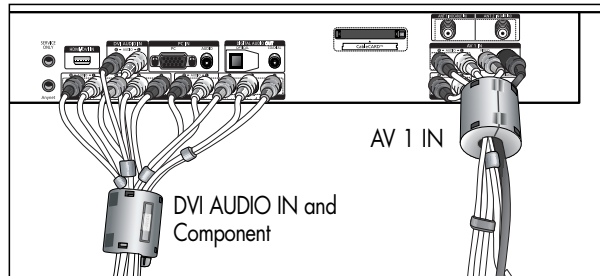
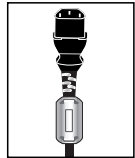

Checking Accessories

Once you have unpacked your TV, check to make sure that you have all the parts shown here. If any piece is missing or broken, call your dealer.



Owner's Instructions

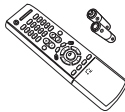

Remote Control (BN59-00462A) /
AAA Batteries



Warranty Card/
Registration Card/
Safety Guide Manual
(Not available in all locations)

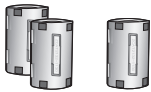

Three Ferrite Cores used for
External Input Cables
(3301-001305)



Ferrite Core for
Power Cord
(3301-001110)



Power Cord
(3903-000085)



AnyNet Cable
(BN39-00518A)

The following parts are sold separately and are available at most electronics stores.



S-VIDEO Cable



HDMI Cable



HDMI/DVI cable



Component Cables (RCA)



PC Cable



PC Audio Cable



Optical Cable



Coaxial Cable



Antenna Cable

Rear Panel

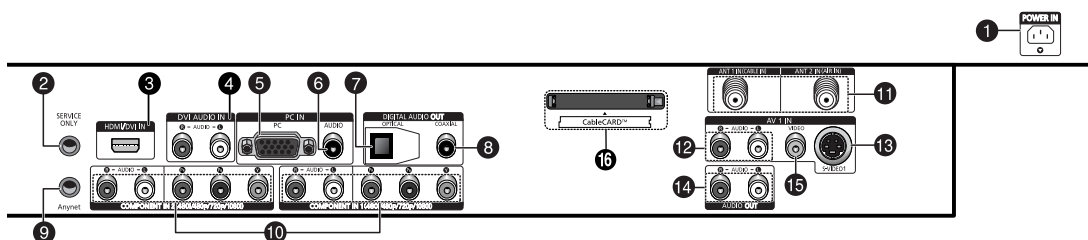

1 POWER IN

Connect the supplied power cord.

2 SERVICE ONLY

Connector for service only.

3 HDMI/DVI IN

Connect to the HDMI jack of a device with HDMI output.

These inputs can also be used as a DVI connection with separate analog audio inputs. An optional HDMI/DVI cable will be necessary to make this connection.

When using the optional HDMI adapter, the DVI analog audio inputs on your TV allow you to receive left and right audio from your DVI device. (Not compatible with PC)

4 DVI AUDIO IN (AUDIO-L/R)

Connect to the DVI audio output jack of an external device.

5 PC IN

Connect to the video output jack on your PC.

6 PC AUDIO IN

Connect the audio output jack on your PC.

7 OPTICAL DIGITAL AUDIO OUT

Connect to a Digital Audio component.

8 COAXIAL DIGITAL AUDIO OUT

Connect to a Digital Audio component.

9 Anynet

Please refer to the Anynet Owner's Instruction. This jack is for connecting to other Samsung Anynet-enabled devices.

10 COMPONENT IN 1, 2

Video (Y/Pb/Pr) and audio (L-AUDIO-R) component inputs.

11 ANT 1 IN (CABLE IN)/ANT 2 IN (AIR IN)

75Ω Coaxial connector for Antenna/Cable Network.

12 AV 1 IN (AUDIO-L/R)

Audio inputs for external devices, such as a camcorder or VCR.

13 AV 1 IN (S-VIDEO1)

Video input for external devices with an S-Video output, such as a camcorder or VCR.

14 AUDIO OUT

Audio outputs for external devices.

15 AV 1 IN (VIDEO)

Video input for external devices, such as a camcorder or VCR.

16 CableCARD™

Insert the CableCARD into the slot. (Refer to page 31)

Note

- Please be sure to match the color coded input terminals and cable jacks.



Remote Control Buttons

Remote Control

- 1 POWER button**
Turns the TV on and off.
- 2 GUIDE button**
Press to display the on-screen Electronic Program Guide (EPG).
- 3 ANTENNA button**
Press to select "Air" or "Cable".
- 4 Number buttons**
- 5 - button**
Press to select additional channels (digital and analog) being broadcast by the same station. For example, to select channel "54-3", press "54", then press "-" and "3".
- 6 MUTE button**
Press to mute the TV sound.
- 7 VOL (Volume) buttons**
Use it to adjust volume.
- 8 Anynet button**
Runs the Anynet view functions and sets up Anynet devices. Please refer to the Anynet Owner's Instruction.
- 9 MENU button**
Displays the main on-screen menu.
- 10 ENTER button**
Confirms a selection.
- 11 FAV.CH button**
Press to switch to your favorite channels.
- 12 CH LIST button**
Displays the channel list.
- 13 MODE button**
Selects a target device to be controlled by the Samsung remote control (i.e., TV, STB, VCR, CABLE, or DVD).
- 14 PRE-CH button**
Tunes to the previous channel.
- 15 SOURCE button**
Press to display all of the available video sources (TV, AV1, AV2, S-Video1, S-Video2, Component1, Component2, PC, and HDMI).
- 16 CH (Channel) buttons**
Use it to switch channels.
- 17 INFO button**
Press to display information on the TV screen.
- 18 EXIT button**
Press to exit the menu.
- 19 Up/Down/Left/Right buttons**
Control the cursor in the menu.

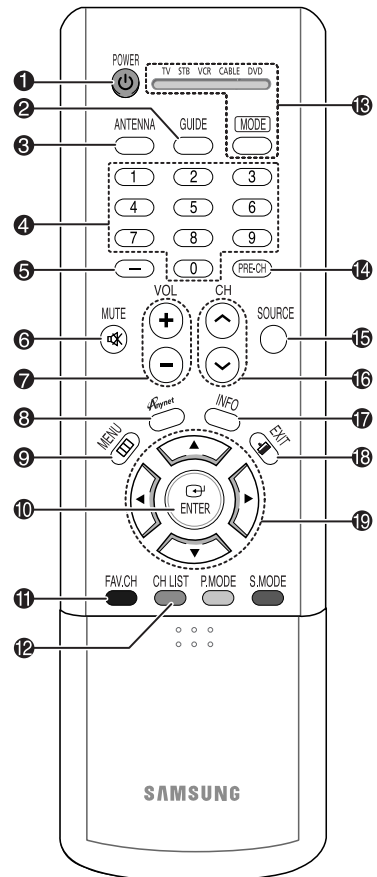

- 20 P.MODE button**
Adjust the TV picture by selecting one of the preset factory settings (or select your personal, customized picture settings). (Refer to page 50)
- 21 S.MODE button**
Select Sound effect.
- 22 E.SAVING button**
Press to adjust screen brightness according to surrounding environment. (Refer to page 114)
- 23 P.SIZE button**
Select Picture size. (Refer to page 54)
- 24 DNle button**
Activates DNle Demo. (Refer to page 53)
- 25 MTS button**
Press to choose stereo, mono or Separate Audio Program (SAP broadcast).
- 26 SET button**
Used during set up of this Samsung remote control, so that it will work compatibly with other devices (VCR, Cable Box and DVD).
- 27 PIP button**
Activates picture in picture. (Refer to page 56)
- 28 PIP control buttons**
CH (▲), (▼): Displays the available channels in sequence. (These buttons change channels in the PIP window only.)
- 29 CAPTION button**
Controls the caption decoder.
- 30 VCR, DVD control buttons**
Controls VCR tape or DVD disc functions: Stop, Rewind, Play/Pause, and Fast Forward.
- 31 RESET button**
If your remote control is not functioning properly, take out the batteries and press the reset button for about 2~3 seconds. Re-insert the batteries and try using the remote control again.

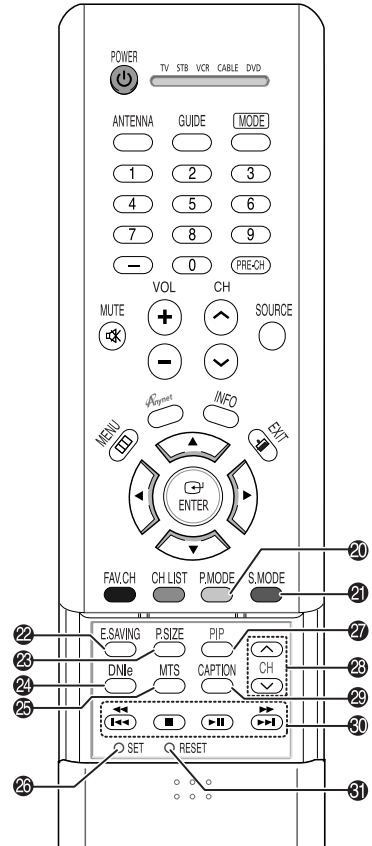

Installing the Batteries in Your Remote Control

1 Slide the back cover to open the battery compartment of the remote control.

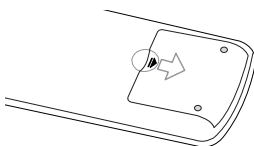

2 Install two AAA size batteries. Make sure to match the "+" and "-" ends of the batteries with the diagram inside the compartment.
• Do not mix battery types, i.e. alkaline and manganese.

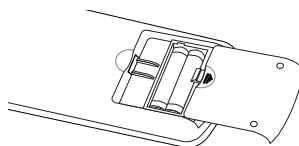

3 Slide the cover back into place.

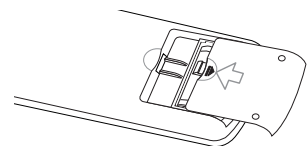

Remote Control Operation Range

You can use your remote control within a distance of 23 feet and an angle of 30 degrees from the left and right sides of the TV's remote control receiver.



Wall Installation Instructions

Refer to the correct installation guide according to your wall bracket.

● Installation Notes

- 1 Contact a technician for installing the wall bracket.
- 2 Samsung Electronics is not responsible for any damage to the product or injury to yourself or others if you elect to perform the wall installation.
- 3 This product is for installing on cement walls. The product may not stay in place when installed on plaster or wood (Ask your dealer).
- 4 Connect all external devices prior to installing the wall bracket.
- 5 The package contents and parts supplied for the wall mount are subject to change without prior notice.

● Parts (Wall attachment panel is sold separately. Check with your dealer.)

Only use the components and accessories shipped with the panel.

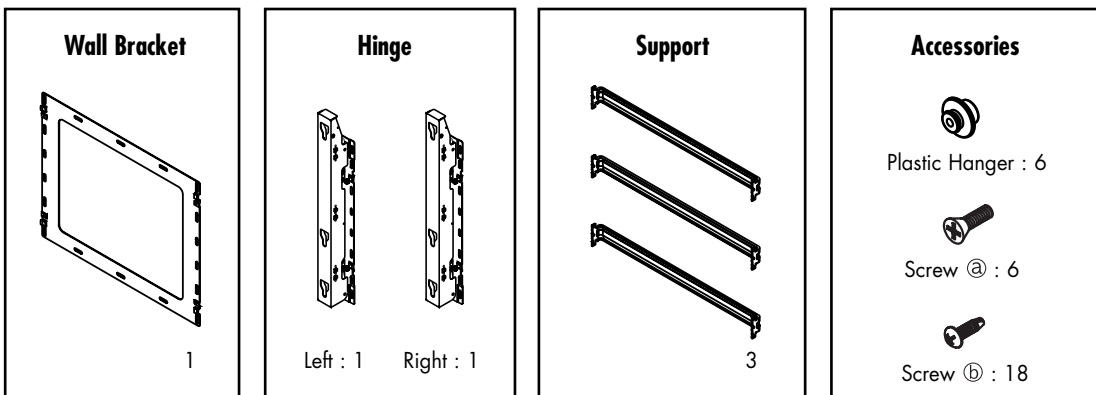

● How to assemble the Wall Mount Bracket

- 1 Insert and tighten the Captive Screw in the direction of the arrow. When done, mount the wall bracket on the wall.

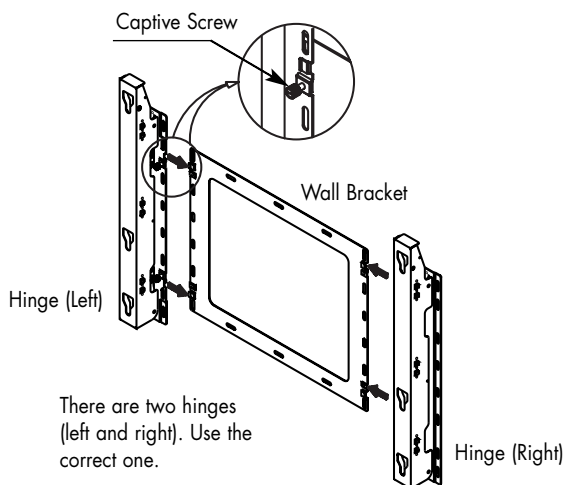

- 2 Assemble the Support as shown in the following figure and fasten it with the screws after attaching it to the wall. (The number of supplied screws ① is 18. For your safety, fasten all 18 screws).

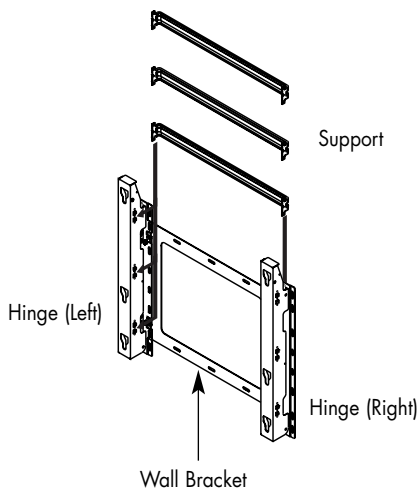

- 3 After fastening the screws, check if the support is properly installed as shown in the figure below.

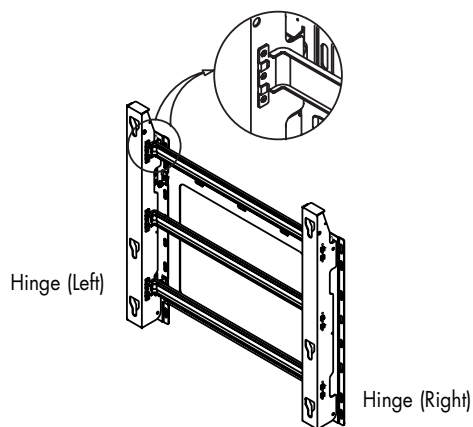

● Fixing the TV panel to the wall attachment panel bracket

The shape of the product may vary depending on the model. (The assemblies of the plastic hanger and the screw are the same)

1 Remove the 6 screws on the back of the product.

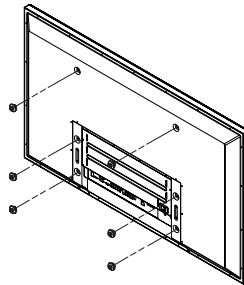

2 Insert the screw ③ into the plastic hanger. (See the figure below)

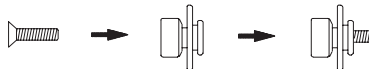

- Mount the product on the wall bracket and make sure it is properly fixed to the left and right plastic hangers.
- Be careful when installing the product on the bracket as fingers can be caught in the holes.
- Make sure the wall bracket is securely fixed to the wall, or the product may not stay in place after installation.

3 Tighten the 6 screws in step 2 (plastic hanger + screw ③) to the rear holes of the product.

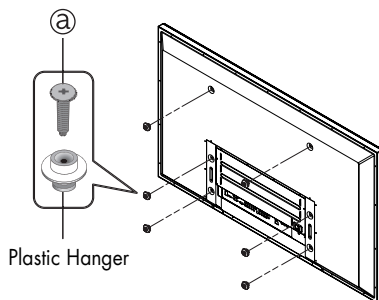

4 Remove safety pin (③) and insert the 4 product holders into the corresponding bracket holes (①). Then place the product (②) so that it is firmly fixed to the bracket. Make sure to reinsert and tighten the safety pin (③) to securely hold the product to the bracket.

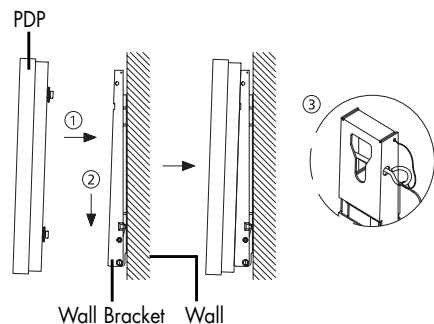

● How to Adjust Mounting Angle

Note : Adjust the bracket angle to 0° before installing it on the wall.

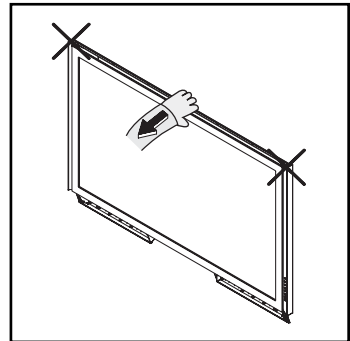
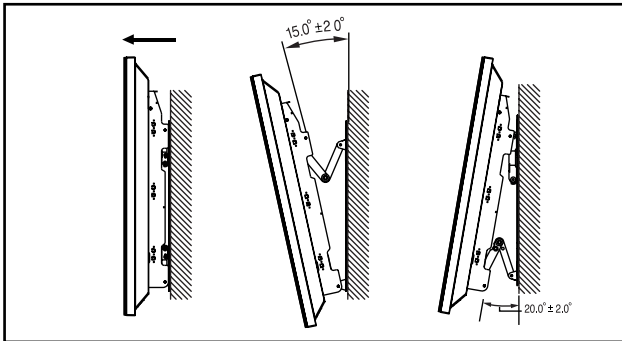

1. Fix the product to the wall bracket.
2. Hold the product at the top in the center and pull it forward (direction of the arrow) to adjust the angle. (See the figure to the right)
3. You can set the angle of the PDP panel as required by adjusting the wall support between 0~15°(±2°) for the upper part and between 0~20°(±2°) for the lower part.

Make sure to use the top center, and not the left or the right side of the product to adjust the angle.



How to assemble the Stand-Base

- 1 Using the 4 screws for securing the stand pegs and the monitor, firmly attach the monitor to the stand pegs. (The exterior of the set may be different than the picture.)

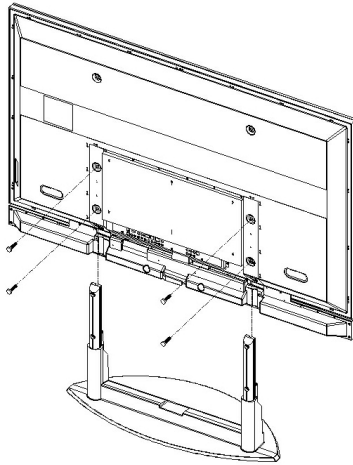

Warning

Firmly secure the stand to the TV before moving it, as the stand may fall and could cause serious injury.

- Two or more people should carry the TV. Never lay the TV on the floor because of possible damage to the screen. Always store the TV upright.

P L A S M A D I S P L A Y P A N E L

Connections



Connecting VHF and UHF Antennas	20
Connecting Cable TV.....	21
Connecting a VCR.....	23
Connecting a Camcorder	24
Connecting a DVD Player (480i, 480p).....	25
Connecting a DTV Receiver (480p, 720p, 1080i)	26
Connecting to HDMI (High Definition Multimedia Interface) (480p, 720p, 1080i)	27
Connecting a Digital TV Set-Top Box (480p, 720p, 1080i)	28
Connecting a Digital Audio System	29
Connecting to an Analog Amplifier	30
Connecting CableCARD.....	31



Connecting VHF and UHF Antennas

Antennas with 75-ohm Round Leads

If your antenna looks like this:  it has 75-ohm round leads.

- 1 Plug the antenna lead into the ANT 2 IN (AIR IN) on the TV.
Use an antenna cable. (Sold Separately)

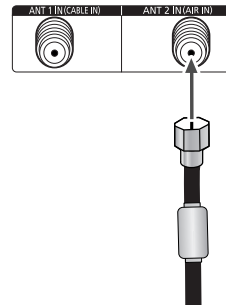



Connecting Cable TV

You can connect different cable systems to your TV, including cable without a Cable box, and cable with a Cable box that descrambles some or all channels.

Cable without a Cable Box

- 1 Plug the incoming cable into the ANT 1 IN (CABLE IN) on the TV.
Use an antenna cable. (Sold Separately)

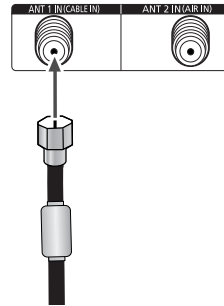

Cable with a Cable Box that Descrambles All Channels

- 1 Find the cable connected to the ANTENNA OUT terminal on your Cable box. This terminal might be labeled "ANT OUT", "VHF OUT" or simply "OUT".

- 2 Connect the cable to the ANT 1 IN (CABLE IN) on the TV.
Use an antenna cable. (Sold Separately)

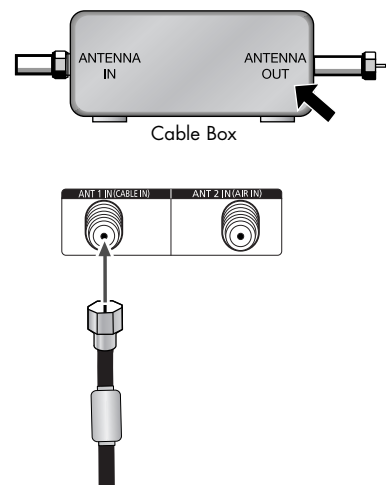

Cable with a Cable Box that Descrambles Some (But Not All) Channels

To complete this connection you will need a two-way splitter, an RF (A/B) switch, and four coaxial cables (which you can buy from your Samsung dealer or any electronics store).

- 1 Find and disconnect the cable that is connected to the ANTENNA IN terminal of your Splitter. This terminal might be labeled "ANT IN", "VHF IN" or simply, "IN". Connect this cable to a two-way splitter.

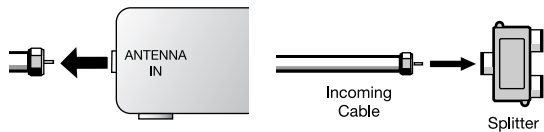

- 2 Connect a coaxial cable between an OUT terminal of the splitter and the IN terminal of the Cable box.

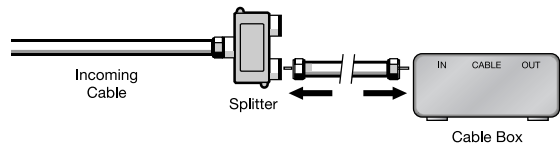

- 3 Connect a coaxial cable between the ANTENNA OUT terminal of the Cable box and the B-IN terminal of the RF (A/B) switch.

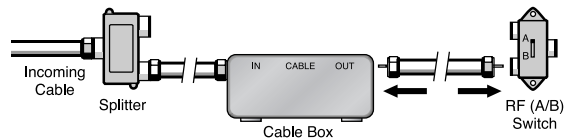

- 4 Connect another cable between the other OUT terminal on the splitter and the A-IN terminal on the RF (A/B) switch.

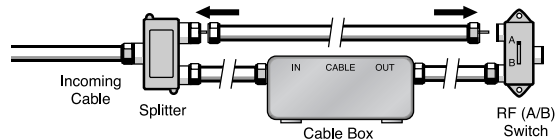

- 5 Connect the last coaxial cable between the OUT terminal of the RF (A/B) switch and the ANT 1 IN (CABLE IN) on the TV.

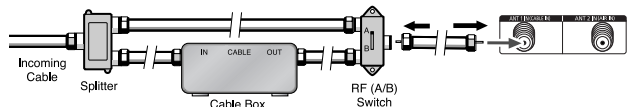

After you've made this connection, set the A/B switch to the "A" position for normal viewing. Set the A/B switch to the "B" position to view scrambled channels. (When you set the A/B switch to "B", you will need to tune your Set-Top Box to the Cable box's output channel, which is usually channel 3 or 4.)



Connecting a VCR

Connecting a VCR to the Video or S-Video/Audio jack

TV Rear Panel

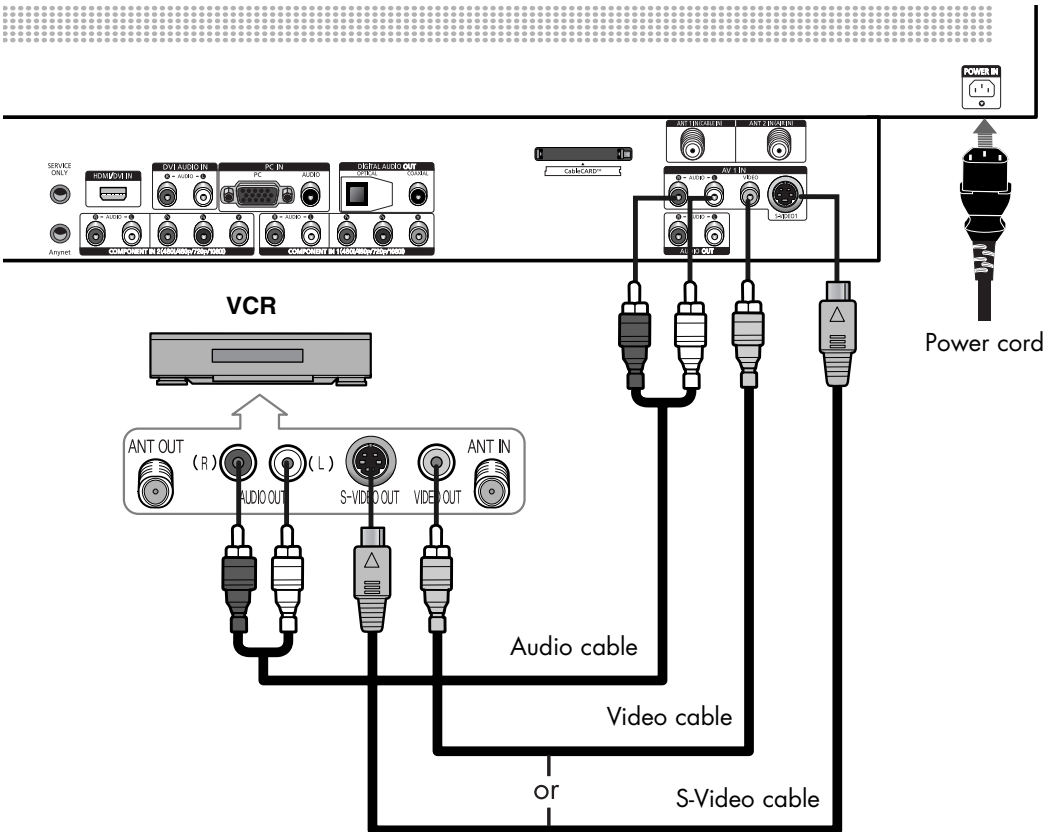

How to Connect

Connect the Video/Audio cables between the VIDEO or S-VIDEO/AUDIO input jacks on the TV and VIDEO or S-VIDEO/AUDIO output jacks on the VCR.
(Note: For better video, use an S-Video cable.)

Note

- Please be sure to match the color coded input terminals and cable jacks.

Videotape Playback:

1. Turn on your TV.
2. Turn on your VCR, insert a videotape and press the Play button.
3. Press the SOURCE button to select "Video (AV1 or AV2)" or "S-Video (S-Video1 or S-Video2)".



Connecting a Camcorder

Viewing camcorder playback

Side of the TV

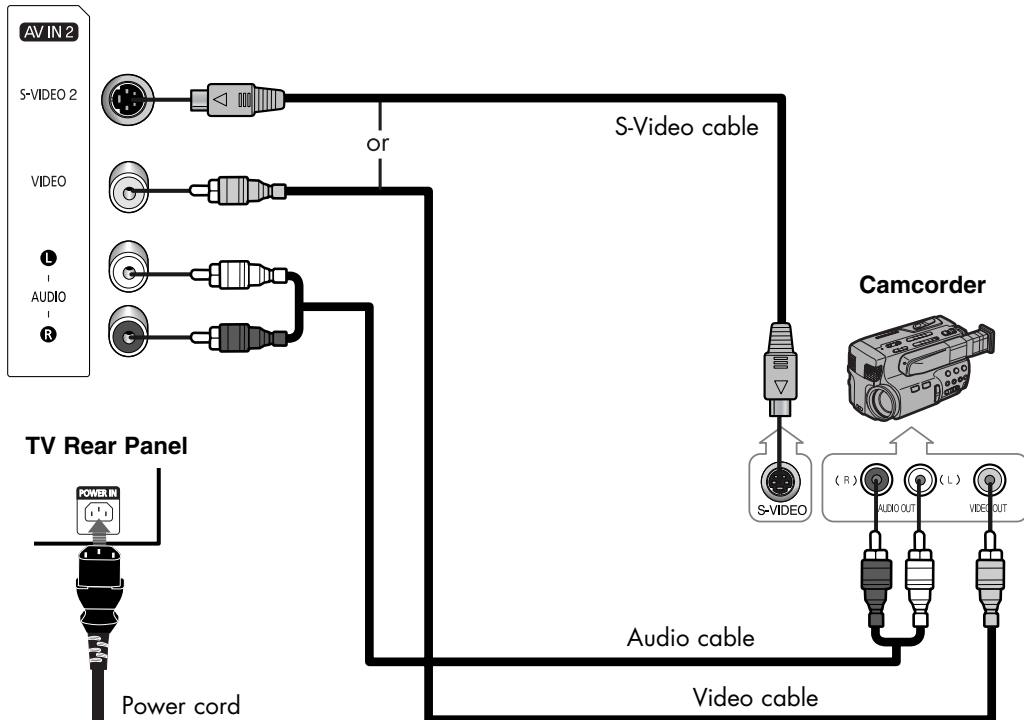

How to Connect

Connect a Video/Audio cable between the VIDEO or S-VIDEO/AUDIO input jacks on the TV and the VIDEO or S-VIDEO/AUDIO output jacks on the camcorder.
(Note: For better video, use an S-VIDEO cable.)

Note

- Please be sure to match the color coded input terminals and cable jacks.

Viewing Tapes

1. Turn on your TV.
2. Turn on your camcorder and set it to video mode. (For details, refer to your camcorder owner's instructions.)
3. Press the SOURCE button to select "Video (AV1 or AV2)" or "S-Video (S-Video1 or S-Video2)".
4. Set the IN/OUT switch on your camcorder to OUT.
5. Press the Play button on the camcorder.



Connecting a DVD Player (480i, 480p)

Playing DVD

TV Rear Panel

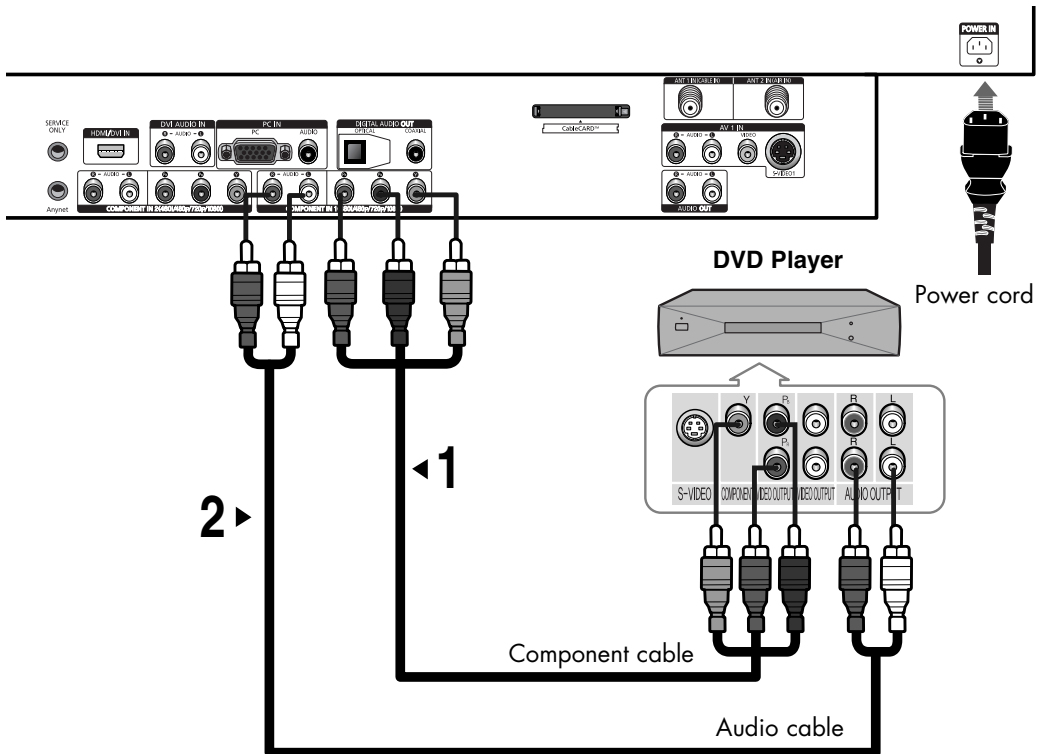

How to Connect

- 1 Connect the Y, Pb, Pr (COMPONENT1, 2) input jacks on the TV to the Y, Pb, Pr output jacks on the DVD player using a component cable.
- 2 Connect the AUDIO L/R (COMPONENT1, 2) input jacks on the TV to the AUDIO output jacks on the DVD player using a audio cable.

Note

- Please be sure to match the color coded input terminals and cable jacks.

To Play DVD:

1. Turn on your TV.
2. Turn on your DVD player, insert a DVD disc and press the Play button.
 - For an explanation of component video, see your DVD player's owner's instructions.
3. Press the SOURCE button to select "Component 1" or "Component 2".



Connecting a DTV Receiver (480p, 720p, 1080i)

This TV displays the optimum picture in 720p mode.

Watching DTV

TV Rear Panel

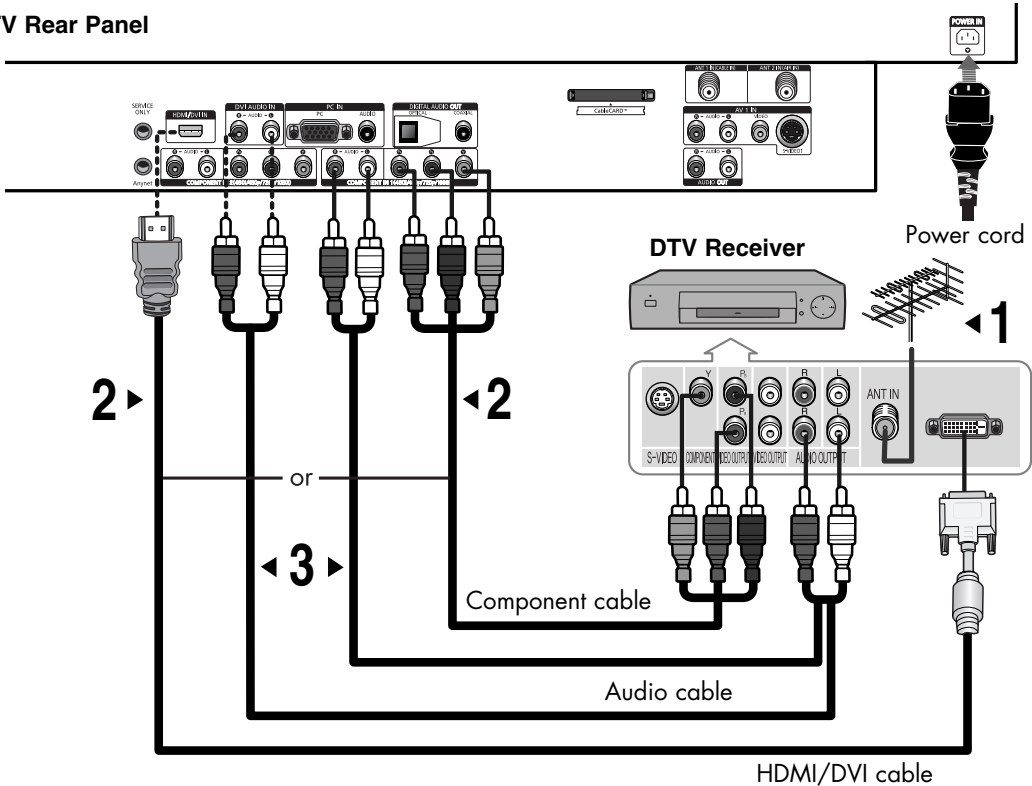

How to Connect

- 1 Connect the cable or antenna to the antenna input jack on the DTV.
- 2 Connect the Y, Pb, Pr (COMPONENT1, 2) or HDMI input jack on the TV to the Y, Pb, Pr or DVI output jacks on the DTV receiver using a component or HDMI/DVI cable.
- 3 Connect the AUDIO L/R (COMPONENT1, 2 or DVI AUDIO IN) input jacks on the TV with the AUDIO output jacks on the DTV receiver using an audio cable.

Note

- Please be sure to match the color coded input terminals and cable jacks.

To Watch DTV:

1. Turn on your TV.
2. Turn on your DTV receiver.
 - For an explanation of component video, see your DTV receiver owner's instructions.
3. Press the SOURCE button to select "Component1", "Component2" or "HDMI".

Plasma Display



Connecting to HDMI (High Definition Multimedia Interface) (480p, 720p, 1080i)

Watching DTV

TV Rear Panel

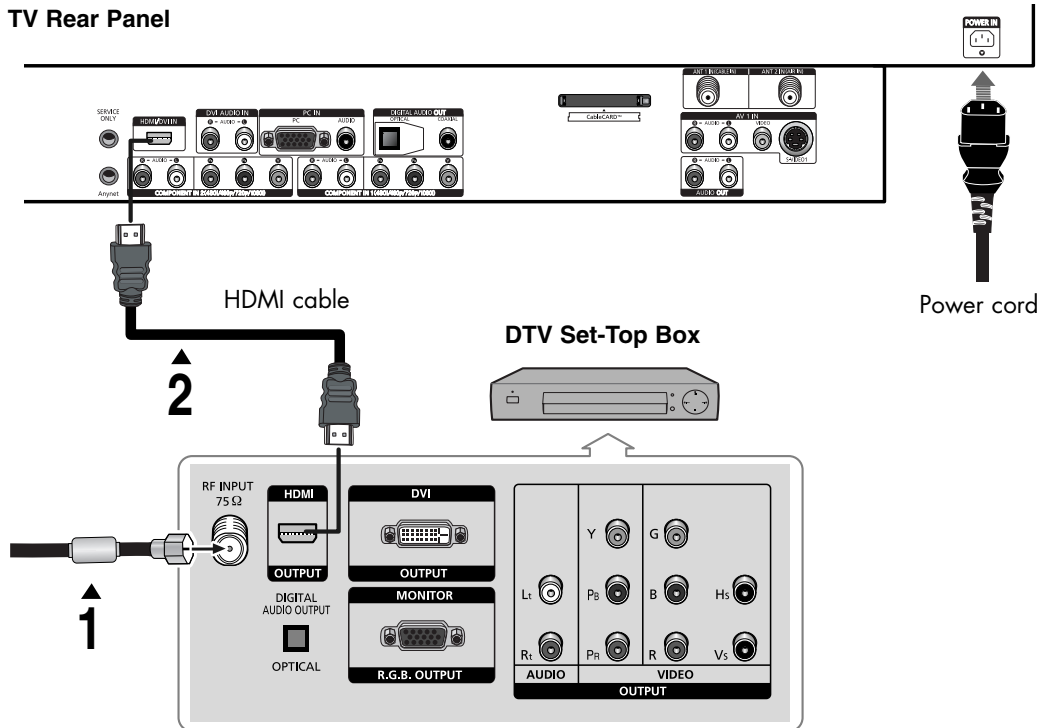

How to Connect

- 1 Connect the cable or antenna to the antenna input jack on the DTV.
- 2 Connect the HDMI input jack on the TV with the HDMI output jack on the DTV Set-Top Box using an HDMI cable.

Note

- Please make sure the HDMI source's power is on before selecting HDMI from the "Source List" on the TV.

To Watch DTV:

1. Turn on your TV.
2. Turn on your DTV receiver.
 - For an explanation of HDMI video, see your DTV receiver owner's instructions.
3. Press the SOURCE button on your TV to select "HDMI".



Connecting a Digital TV Set-Top Box (480p, 720p, 1080i)

By inputting a high-bandwidth digital content protection High-Definition picture source to the HDMI input jack on the TV, High-Definition pictures can be displayed on the screen in their digital form.

Connecting to HDMI (High Definition Multimedia Interface)/DVI Compatible

TV Rear Panel

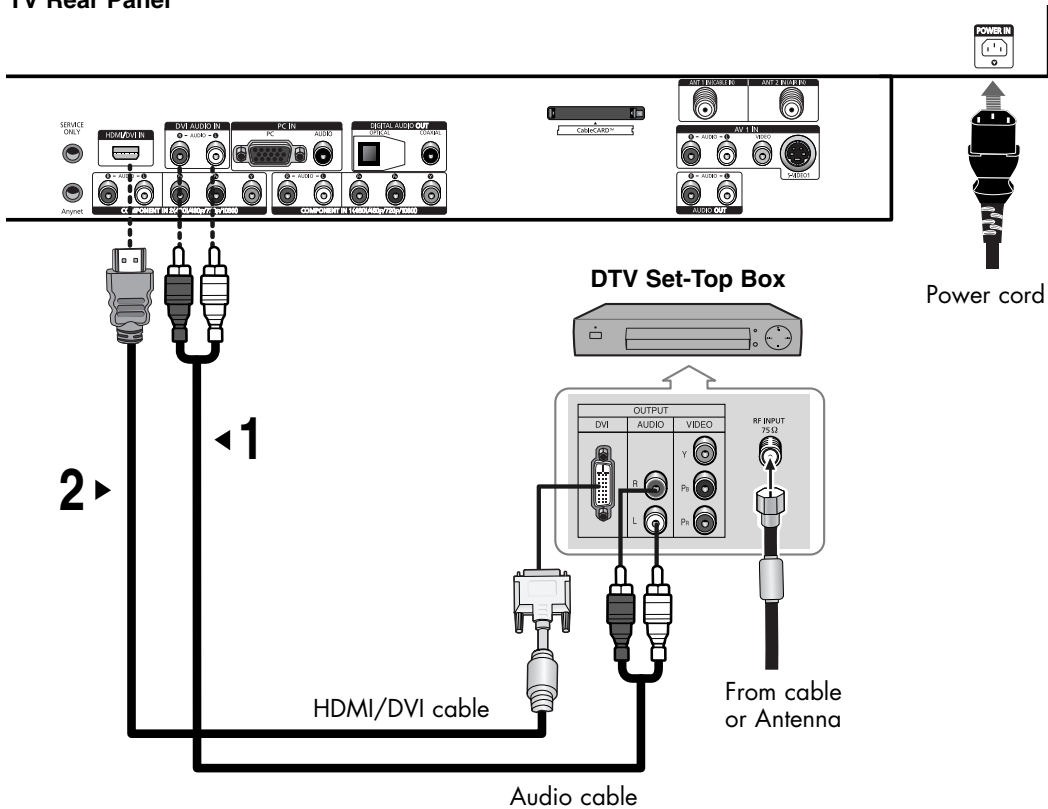

How to Connect

- 1 Connect the DVI AUDIO (L, R) input jacks on the TV with the AUDIO output jacks on the Set-Top Box using an audio cable.

Note

- Use analog stereo audio inputs when using the HDMI input with a device that outputs DVI instead of HDMI.

- 2 Connect the HDMI input jack on the TV and the DVI output jack on the Set-Top Box using an HDMI/DVI cable.

Note

- The HDMI IN jack is not compatible with PC.



Connecting a Digital Audio System

There are many types of digital audio systems on the market today. A simplified illustration of an audio system is shown below. For more information, see your audio system owner's manual.

TV Rear Panel

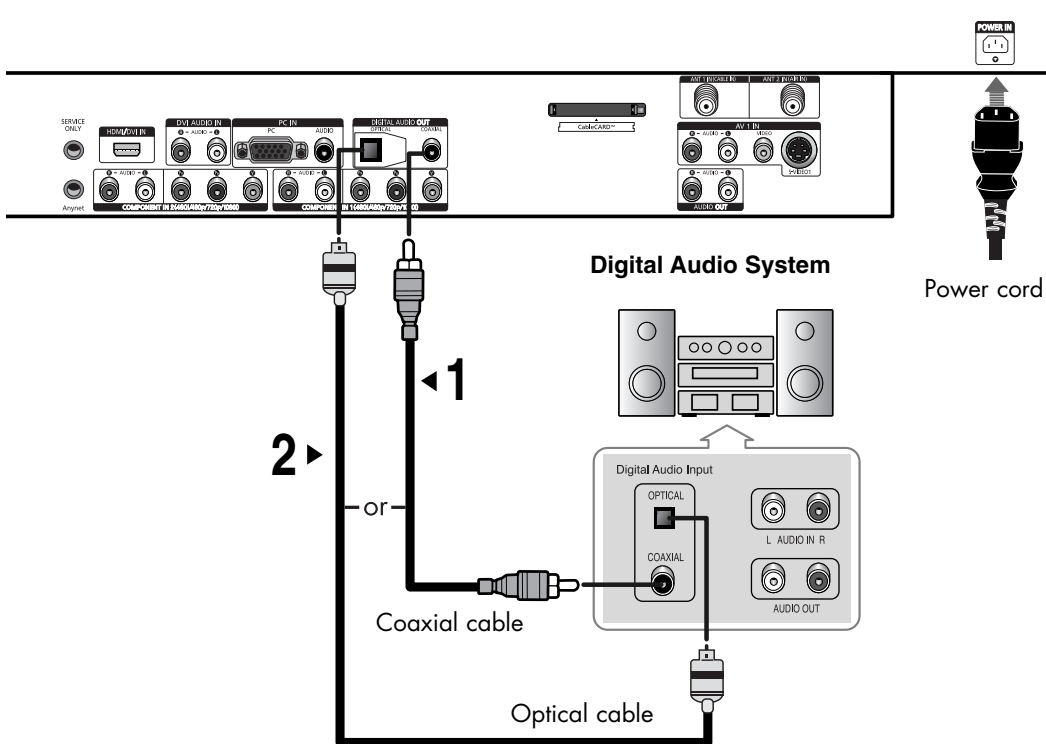

How to Connect

- 1 If your audio system has a coaxial digital audio input, connect to the "COAXIAL" output jack on the TV.
- 2 If your audio system has a optical digital audio input, connect to the "OPTICAL" output jack on the TV.
Be certain to remove the black cover from the optical output before inserting the cable.
- 3 If your system has both coaxial and optical digital audio inputs, SAMSUNG recommends you use the optical digital output on the TV.
Do not connect both optical and coaxial cables. This may damage your audio system.
 - OPTICAL: converts the electric signal into an optical light signal, and transmits it through glass fibers.
 - COAXIAL: The digital audio signal is received through a coaxial copper cable.



Connecting to an Analog Amplifier

TV Rear Panel

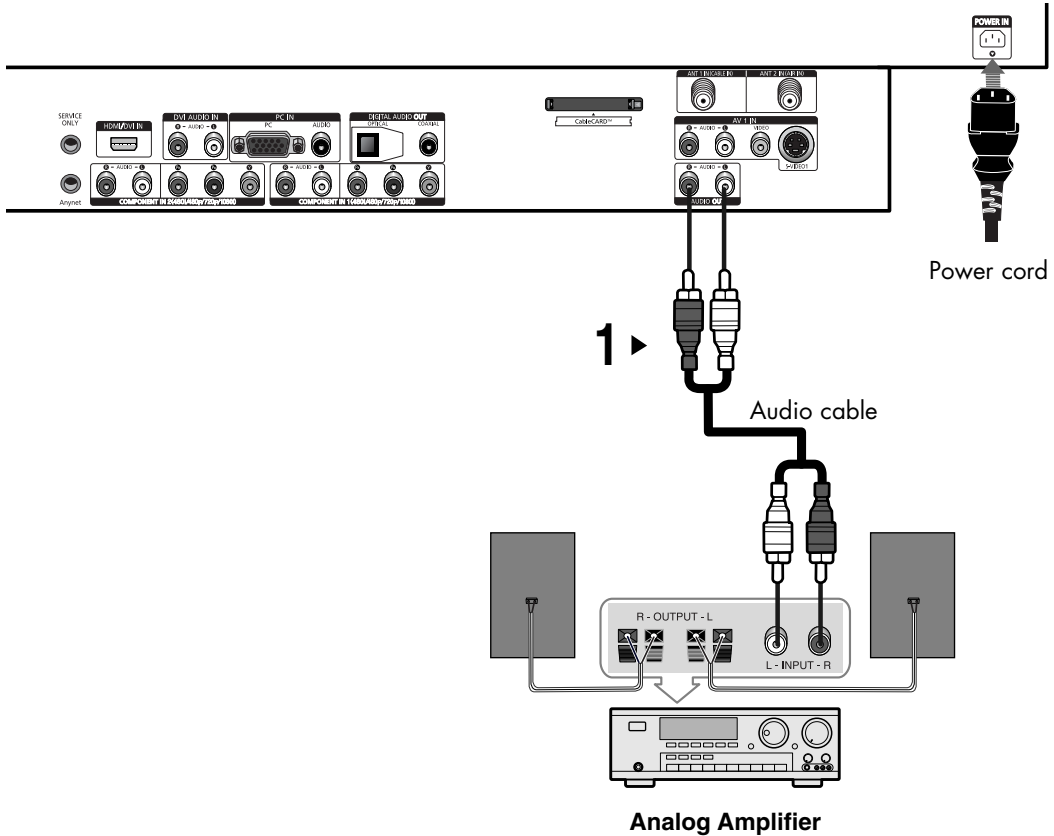

How to Connect

- 1 The "AUDIO OUT (AUDIO L/R)" terminals cannot be used for external speakers. You must hook them up to an amplifier.

When an audio amplifier is connected to the "AUDIO OUT (AUDIO L/R)" terminals: Decrease the gain (volume) of the audio amplifier, turn the TV's internal mute on and adjust the volume level with the volume control of the amplifier.



Connecting CableCARD

You must obtain a CableCARD from a local cable service provider.

TV Rear Panel

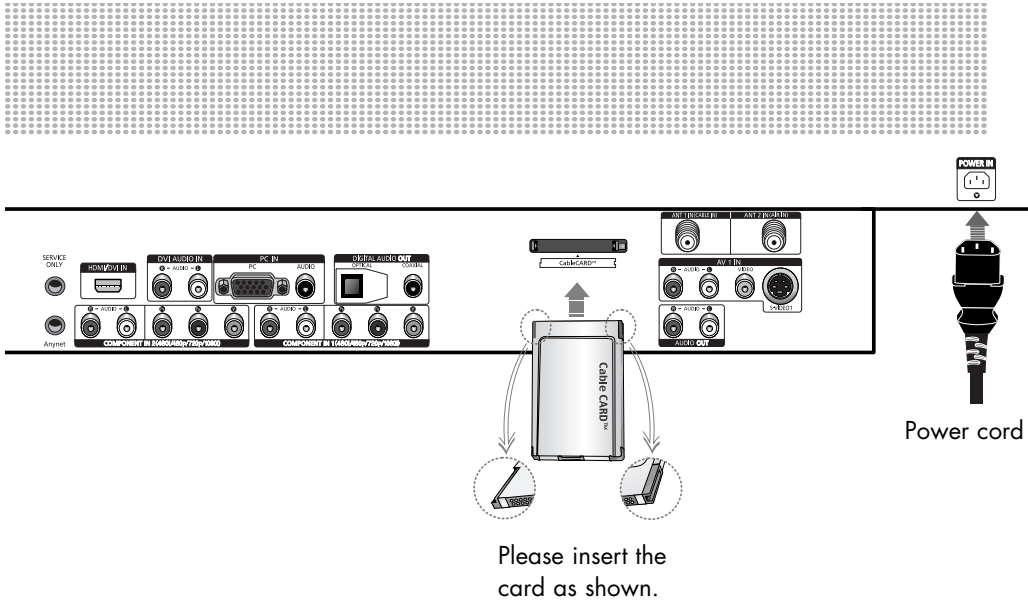

How to Connect

- 1 Insert the CableCARD into the "CableCARD" slot and the message "CableCARD™ Inserted" is displayed on the screen. If the channel information does not already exist, the message "Updating Channel List" is displayed during channel information configuration.
- 2 When channel information configuration is finished, the message "Updating Completed" is displayed. It indicates that the channel list is now updated.

P L A S M A D I S P L A Y P A N E L

Operation



Turning the TV On and Off.....	34
Viewing the Menus and Displays	38
Memorizing the Channels	39
Adding and Erasing Channels	41
Setting Up Your Remote Control	44
Viewing an External Signal Source	46



Turning the TV On and Off

Turning the TV On and Off

Press the POWER button on the remote control.
The TV will be turned on and you will be able to use its features.
You can also use the Power button on the front of the TV.

Note

- If your TV isn't turned on when the POWER button is pressed:
Press the **MODE** button to check if the TV mode has been chosen.

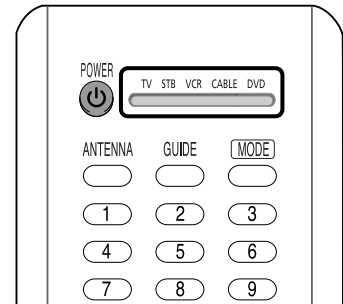

Plug & Play Feature

When the TV is initially powered On, basic customer settings proceed automatically and subsequently: Setting the language, checking the antenna input, memorizing the channels, and setting the time.

Note

- The Plug & Play function operates after plugging in the TV for the first time.

- 1 Press the POWER button on the remote control.
The message "Menu language, Channels and Time will be set." is displayed.
Press the ENTER button, then "Select the language of the OSD." menu is automatically displayed.

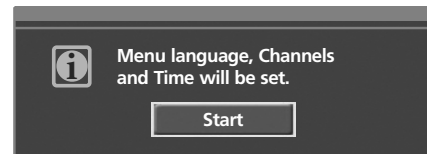

- 2 Press the ENTER button to enter the language.
Press the ▲ or ▼ button to select language, then the ENTER button. "Select the antennas to memorize." menu is automatically displayed.



- 3** Press the ▲ or ▼ button to memorize the channels of the selected connection.
Press the ENTER button to select "Start".

Notes

- If the antenna is connected to ANT 1 IN (CABLE IN), select "Cable" and if it is connected to ANT 2 IN (AIR IN), select "Air".
- If both ANT 1 IN and ANT 2 IN are connected, select the "Air + Cable".

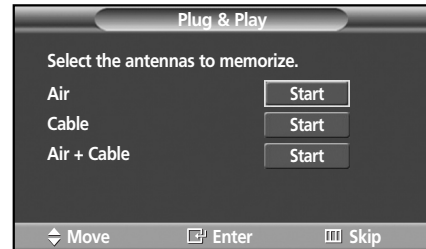

- 4** Select the correct signal source (STD, HRC, and IRC) by pressing the ▲ or ▼ button, then press the ENTER button.

Note

- STD, HRC, and IRC identify various types of cable TV systems. Contact your local cable company to identify the type of cable system that exists in your particular area. At this point the signal source has been selected. Proceed to "Storing Channels in Memory" on page 40.

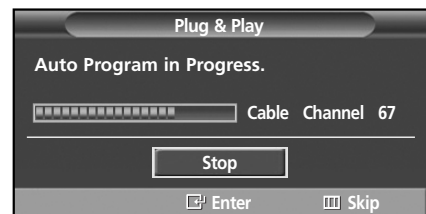
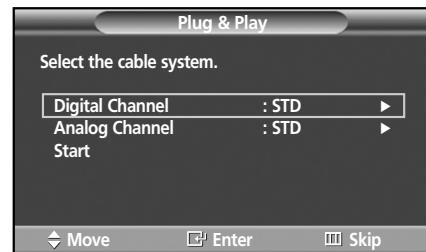

- 5** The TV will begin memorizing all of the available channels.
After all the available channels are stored, the Auto program menu reappears.
Press the ENTER button at any time to interrupt the memorization process.
Press the ENTER button to select OK when channel memorization is complete.
"Set to daylight savings time." menu is automatically displayed.

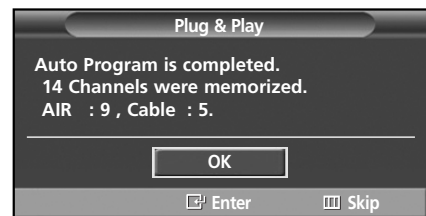

-
- 6 Press the ENTER button. Press the ▲ or ▼ button to select “Yes” or “No”, then the ENTER button. “Select the time zone in which you live” menu is automatically displayed.

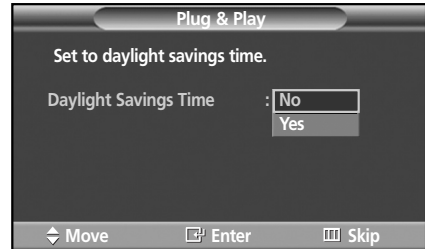

-
- 7 Press the ▲ or ▼ button to highlight the time zone for your local area (and to move the highlight to the appropriate time zone on the map of the United States). Press the ENTER button.

If you have received a digital signal, the time will be set automatically. If not, see page 98 to set the clock.



-
- 8 The message “Completed. Time will be updated automatically.” is displayed. When you have finished, press the ENTER button.

- The message will automatically disappear after a few seconds, even if the ENTER button is not pressed.

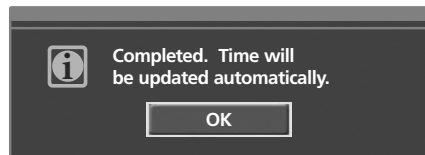

To reset this feature...

1 Press the MENU button. Press the ▲ or ▼ button to select "Setup", then press the ENTER button.



2 Press the ENTER button to select "Plug & Play".

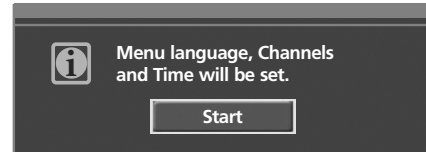

3 For further details on setting up options, refer to the previous page.

Note

- Plug and Play can only be accessed in the TV mode.



Viewing the Menus and Displays

Your TV has a simple, easy-to-use menu system that appears on the TV screen. This system makes it convenient and fast to use features on the TV. Your TV also lets you display the status of many of your TV's features.

Viewing the Menus

- 1 With the power on, press the MENU button on the remote control. The main menu appears on the screen. The Input menu is selected.



- 2 Press the ▲ or ▼ button to move to items in the menu. Press the ◀/▶/ENTER buttons to display, change, or use the selected items.

Press the ENTER button to enter items in the menu. On screen menus disappear from the screen automatically after about two minutes or you can press the EXIT button on your remote control to exit the menu.

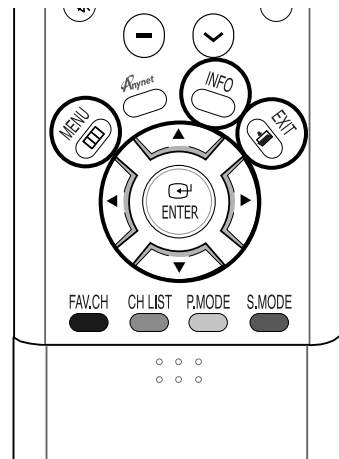

Displaying Status Information

Press the INFO button on the remote control. The TV will display the Picture Mode, Sound Mode, MTS, V-Chip, and Current Time.

Note

- The INFO window automatically disappears after a few seconds. Press the INFO button once to manually close the window.

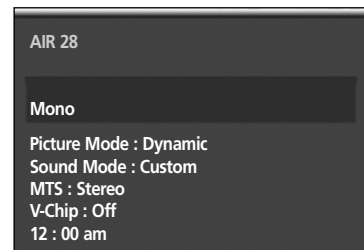



Memorizing the Channels

Your TV can memorize and store all of the available channels for both “off-air” (antenna) and cable channels. After the available channels are memorized, use the CH \wedge and CH \vee buttons to scan through the channels. This eliminates the need to change channels by entering the channel digits. There are three steps for memorizing channels: selecting a broadcast source, memorizing the channels (automatic) and adding and deleting channels (manual).

Selecting a broadcast source

Before your television can begin memorizing the available channels, you must specify the type of signal source that is connected to the TV (i.e., an antenna or a cable system).

- 1 Press the MENU button. Press the \blacktriangle or \blacktriangledown button to select “Channel”, then press the ENTER button.

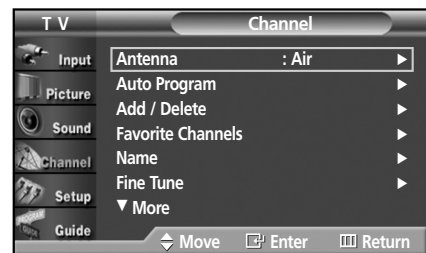

- 2 Press the \blacktriangle or \blacktriangledown button to select “Auto Program”, then press the ENTER button.

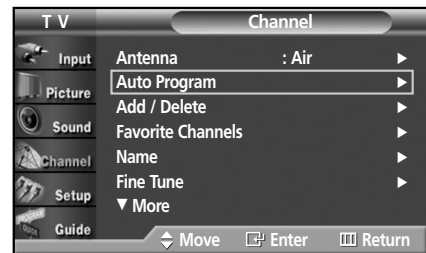

- 3 Press the \blacktriangle or \blacktriangledown button to select the antenna connection, then press the ENTER button.

Notes

- Air : “Air” antenna signal.
- Cable : “Cable” antenna signal.
- Air + Cable : “Air” and “Cable” antenna signals.
- If the antenna is connected to ANT 1 IN (CABLE IN), select “Cable” and if it is connected to ANT 2 IN (AIR IN), select “Air”.
- If both ANT 1 IN and ANT 2 IN are connected, select the “Air + Cable”.

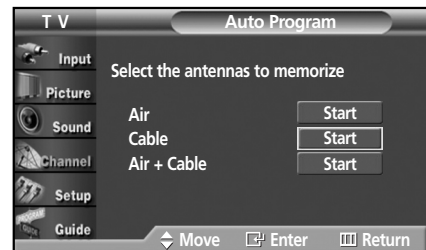
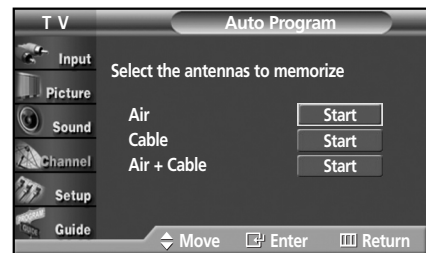

Storing Channels in Memory

- 4 Select the correct signal source (STD, HRC, and IRC) by pressing the ▲ or ▼ button, then press the ENTER button.

Note

- STD, HRC, and IRC identify various types of cable TV systems. Contact your local cable company to identify the type of cable system that exists in your particular area. At this point the signal source has been selected.

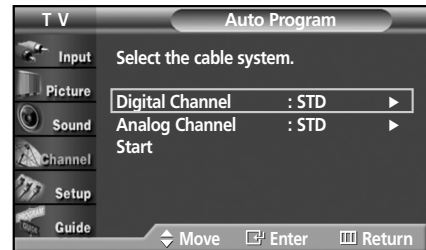

- 5 The TV begins memorizing all available stations. Press the ENTER button at any time to interrupt the memorization process. Press the EXIT button to exit.

Note

- The TV must be connected to an antenna in order to receive digital TV signals. Even if a particular channel is deleted from the memory, you can always tune to that channel directly by using the number buttons on the remote control.

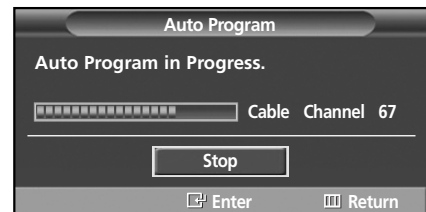

Notes

- All available DTV and analog channels are automatically stored in memory.
- It takes approximately 3 to 10 minutes to memorize channels.



Adding and Erasing Channels

To add channels that were not memorized (or to delete unwanted channels from memory):

- 1 Press the MENU button.
Press the ▲ or ▼ button to select "Channel", then press the ENTER button.

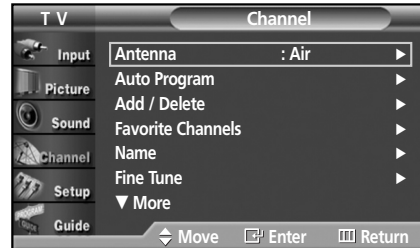

- 2 Press the ▲ or ▼ button to select "Add/Delete", then press the ENTER button.



- 3 Repeatedly pressing the ENTER button will alternate between add channel and delete channel.

Press the CH ^ or CH v button to switch to the appropriate channel, then repeat above.
Press the EXIT button to exit.

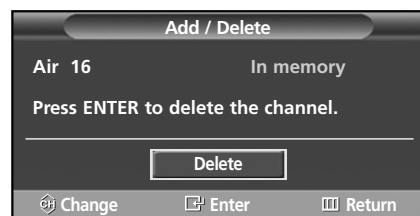
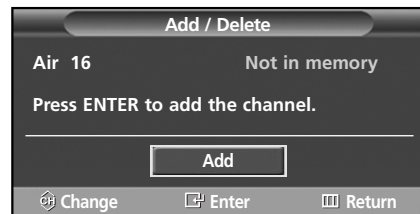

Changing Channels

Using the Channel Buttons

Press the CH \wedge or CH \vee button to change channels.

When you press the CH \wedge or CH \vee button, the TV changes channels in sequence. You will see all the channels that the TV has memorized. (The TV must have memorized at least three channels.) You will not see channels that were either erased or not memorized.

Directly Accessing Channels

Press the number buttons to go directly to a channel. For example, to select channel 27, press "2" then "7".

When you use the number buttons, you can directly select channels that were either erased or not memorized. To change to single-digit channels (0~9) faster, press "0" before the single digit. (For channel "4" press "0", then "4".)

Note

- For quick channel change, press the number buttons and then press ENTER button.

Using the PRE-CH button to select the previous channel

Press the PRE-CH button. The TV will switch to the last channel viewed.

To quickly switch between two channels that are far apart, tune to one channel, then use the number button to select the second channel. Then, use the PRE-CH button to quickly alternate between them.

Adjusting the Volume

Using the Volume Buttons

Press the VOL + or VOL - button to increase or decrease the volume.

Using Mute

Using the MUTE Button

At any time, you can temporarily cut off the sound using the MUTE button.

- 1 Press the MUTE button and the sound cuts off. The word "MUTE" will appear in the lower-left corner of the screen.
- 2 To turn mute off, press the MUTE button again, or simply press the VOL + or VOL - button.

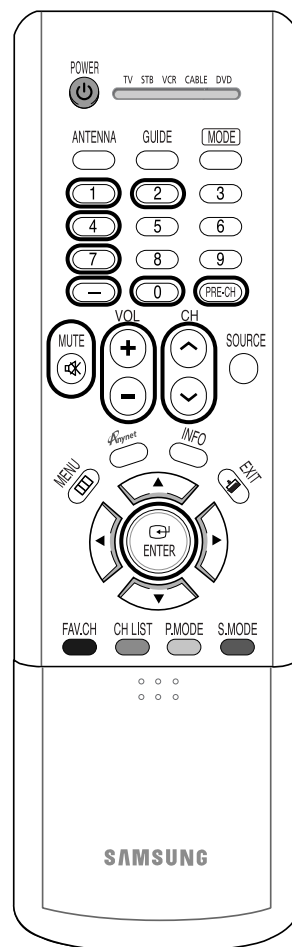

Using the “-” Button

The “-” button is used to select stations that broadcast both a digital and analog signal.

For example, for Channel 7-1 (digital), press “7”, then “-”, then “1”.



For channel 7-2 (analog), press “7”, then “-”, then “2”.

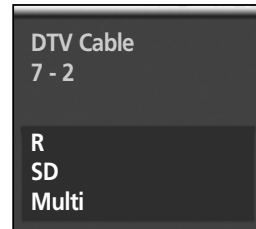

Notes

- HD indicates the TV is receiving a Digital High Definition signal.
SD indicates the TV is receiving a Standard Definition signal.
- For quick channel change, press the number buttons, then press the ENTER button.



Setting Up Your Remote Control

Your TV comes equipped with a universal remote control. In addition to controlling the TV, the universal remote control can also operate a VCR, Cable box, DVD, and some Samsung Set-top boxes (even if your VCR, Cable box and DVD are made by manufacturers other than Samsung).

Note : • The remote control might not be compatible with all DVD Players, VCRs, Cable boxes, and Set-Top Boxes.

Setting Up the Remote to Operate Your VCR, Cable box or DVD player

- 1 Turn off your VCR (or Cable box, DVD player).
- 2 Press the MODE button. The Mode is changed whenever MODE button is pressed.
- 3 Press the SET button on your TV's remote control.
- 4 Using the number buttons on your remote control, enter three digits of the VCR (or Cable box, DVD player) code listed on page 45 of this manual for your brand of VCR (or Cable box, DVD). Make sure you enter three digits of the code, even if the first digit is a "0". (If more than one code is listed, try the first one.)
- 5 Press the POWER button on the remote control. Your VCR (or Cable box, DVD) should turn on if your remote is set up correctly. If your VCR (or Cable box, DVD) does not turn on after setup, repeat steps 2, 3, and 4, but try one of the other codes listed for your brand of VCR (or Cable box, DVD). If no other codes are listed, try each code, 000 through 089 (or Cable box: 000 through 077, DVD player: 000 through 008).

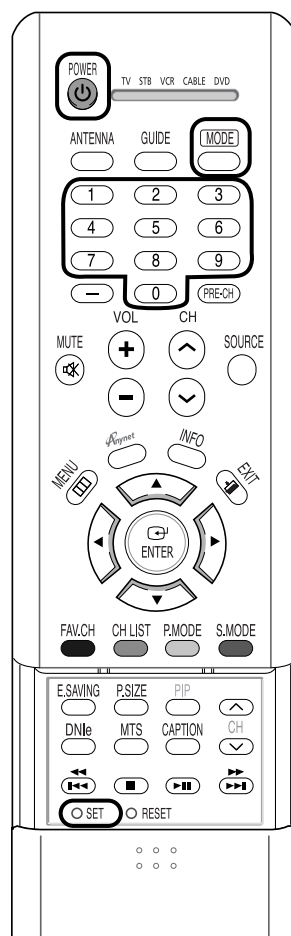

Note

- When your remote control is in "VCR", "CABLE", or "DVD" mode, the VCR control buttons (STOP, REW, PLAY/PAUSE, and FF) still operate your VCR.

Plasma Display

Remote Control Codes

VCR Codes

Admiral	015,088	Hitachi	014,024,044,045	Quasar	017,053
Aiwa	024	Instant Replay	017	Radio Shack	011,015,017,018,021,024,028,036,052,062
Akai	026,031,032	JC Penny	011,014,016,017,023,025,039,044,060,062	RCA	009,014,016,017,037,044,046,063,078
Audio Dynamics	022,025	JCL	011,017,023,025,039,055	Realistic	011,015,017,018,021,024,028,036,052,062
Bell & Howell	011	Kenwood	011,023,025,039,055	Samsung	000,016,022,031,041,051
Broksonic	019	KLH	082	Sansui	025
Candle	016,018,022,054,055,061	LG(Goldstar)	001,002,007,018,023,055,069	Sanyo	011,021
Canon	017,062	Lloyd	024	Scott	022,050,058,077
Citizen	016,018,022,054,055,061	Logik	040	Sears	011,014,018,021,027,028,044,052,057
Colorlyme	023	LXI	024	Sharp	015,036,048,054
Craig	016,021	Magnavox	017,038,062,065	Shintom	026,035,040,064
Curtis Mathes	009,016,017,023,024,055,062,073,076	Marantz	011,017,023,025,038,039,055,070	Signature	024
Daewoo	003,004,005,006,007,008,022,054,085	MTC	016,024	Sony	026,035,047
DB	023,025	Multitech	016,024,040,041	Sylvania	017,024,038,062,065
Dimensia	009	NEC	011,023,025,039,055,070,073	Symphonic	024
Dynatech	024	Optimus	015	Tandy	011,024
Electrohome	036	Panasonic	017,062,084,086	Tatung	039
Emerson	017,018,019,022,024,029,032,036,043,050,051,056,058,066,071,074,076,077,079	Pentax	014,044	Teac	024,039,078
Fisher	011,021,027,028,052,057,067	Pentax Research+	055	Technics	017
Funai	024	Philco	017,038,062,065	Teknika	017,018,024,030
General Electric	009,016,017,041,062	Philips	017,038	TMK	076
Go Video	016	Pioneer	014,025,042,059	Toshiba	014,022,028,057,058
Harman Kardon	023	Portland	053,054,061	Toshiko	018
		PROSCAN	009	Totevision	016,018
		Quartz	011		

Cable Box Codes

Anvision	015,016	Magnavox	015,016,027,029,034,036,037,040,041,048,049	Signature	054
Cable Star	015,016	Nawoo	001	Sprucer	035
DaeHan	005	NSC	017	Starcom	054
DeaRyung	003	Oak	024,046	Stargate2000	066
DongKuk	004	Osk Sigma	024	Sylvania	019,067
Eagle	015,016	Panasonic	011,035,047,069	TaePyungYang	002
Eastern International	020	Philips	015,016,027,029,034,036,037,040,041,048,049	Texscan	019,067
General Instrument	054	Pioneer	026,028,052	Tocom	025,029,057,058,063
GI	012,013,023,031,032,033,038,044,075,076,077	Randek	015,016	Unika	039,040,049
Hamlin	011,012,020,021,042,056	RCA	008,035,074	Universal	059,060
Hitachi	045,051,054	Regal	011,020,021	Viewstar	015,016,027,029,034,036,037,040,041,048,049
Jerrold	012,013,023,031,032,033,038,044,054,070,073	Regency	010,041	Warner Amex	052
LG(Goldstar)	006	Saewoo	007	Zenith	022,050,065,069
Macom	045,051	Samsung	000,011,030,052,071,072		

DVD Codes

Curtis Mathes	009	Philips	007	Sharp	005
JVC	003	PROSCAN	008	Sony	004
LG(Goldstar)	001	RCA	008	Toshiba	002
Panasonic	006	Samsung	000		



Viewing an External Signal Source

Use the remote control to switch between viewing signals from connected equipment, such as VCR, DVD, Set-Top Box, and the TV source (broadcast or cable).

Setting the Signal Source

- 1 Press the MENU button.
Press the ENTER button to select "Input".
**► Quick way to access viewing an external signal source :
Just press "SOURCE" button on the remote control.**

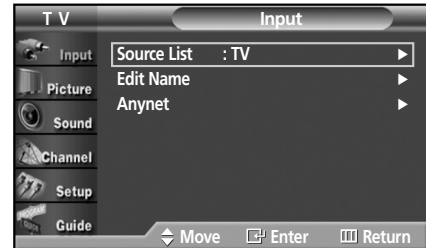

- 2 Press the ENTER button to select "Source List".



- 3 Press the ▲ or ▼ button to select signal source, then press the ENTER button.

Note

- Only connected devices can be selected.



- 4 Press the EXIT button to exit.

Notes

- When you connect equipment to the TV, you can choose between the following sets of jacks: AV1, AV2, S-Video1, S-Video2, COMPONENT 1, COMPONENT 2, PC, or HDMI on the TV's rear panel.
- Before selecting an input source, connect an external device first.
- HDMI input can only be selected when the external device is turned on and connected via HDMI.

Assigning Names to External input mode

- 1 Press the MENU button.
Press the ENTER button to select "Input".

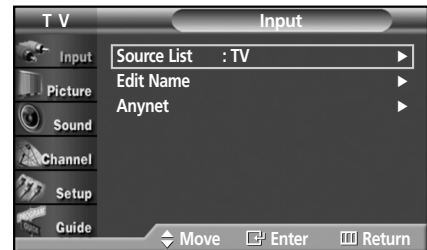

- 2 Press the ▲ or ▼ button to select "Edit Name", then press the ENTER button.



- 3 Press the ENTER button.
Press the ▲ or ▼ button to select external device, then press the ENTER button.
 - You can select the VCR, DVD, D-VHS, Cable STB, HD STB, Satellite STB, PVR STB, AV Receiver, DVD Receiver, GAME, Camcorder, DVD Combo, PC, VOD STB, or TV.
 - Set other signal sources (AV2, S-Video1, S-Video2, Component 1, Component 2, PC, or HDMI) using the same method as listed above.



- 4 Press the EXIT button to exit.

P L A S M A D I S P L A Y P A N E L

Picture Control

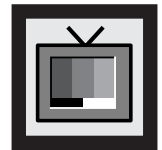

Changing the Picture Standard	50
Customizing the Picture Settings	51
Viewing the DNIe Demonstration	53
Changing the Screen Size	54
Viewing the Picture-in-Picture.....	56
Selecting the Sound Source	62
Setting the My Color Control Mode.....	63

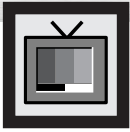

Changing the Picture Standard

You can select the type of picture which best corresponds to your viewing requirements.

1 Press the MENU button. Press the ▲ or ▼ button to select "Picture", then press the ENTER button.

➤ Quick way to access the picture setting: Just press "P.MODE" button on the remote control.

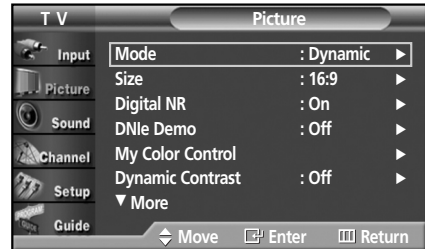

2 Press the ENTER button again to select "Mode".

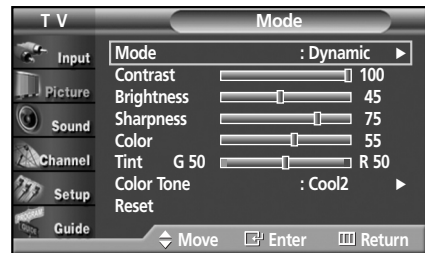

3 Press the ENTER button. Press the ▲ or ▼ button to select the desired picture mode (Dynamic, Standard, Movie, Custom), then press the ENTER button.

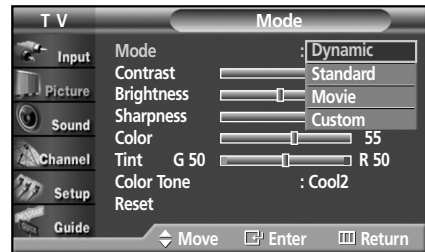

4 Press the EXIT button to exit.

- Choose Dynamic for viewing the TV during the day or when there is bright light in the room.
- Choose Standard for the standard factory settings.
- Choose Movie when viewing the movie.
- Choose Custom if you want to adjust the settings according to personal preference (see "Customizing the Picture Settings", page 51).

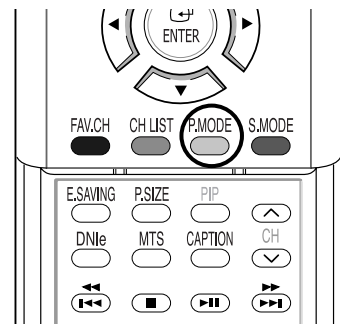

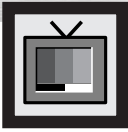

Customizing the Picture Settings

You can use the on-screen menus to change the "Contrast", "Brightness", "Sharpness", "Color", "Tint", and "Color Tone" according to personal preference. You can select "Standard" which automatically recalls your personalized picture settings.

1 Press the MENU button. Press the ▲ or ▼ button to select "Picture", then press the ENTER button.

► Quick way to access the picture setting: Just press "P.MODE" button on the remote control.

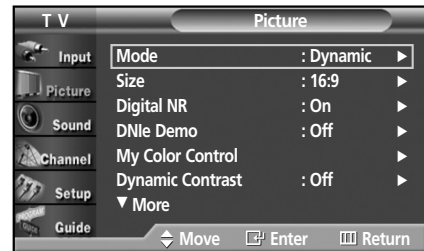

2 Press the ENTER button to select "Mode".

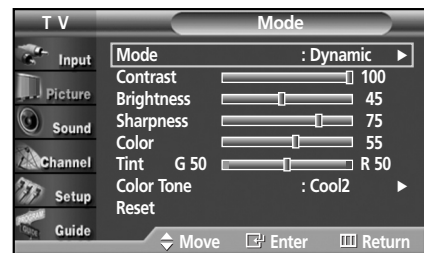

3 Press the ENTER button. Press the ▲ or ▼ button to select the desired picture mode (Dynamic, Standard, Movie, Custom), then press the ENTER button.

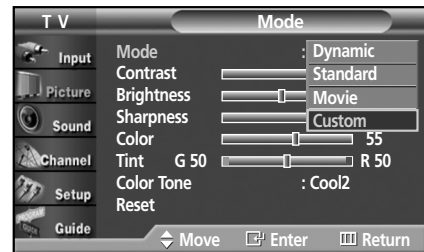

4 Press the ▲ or ▼ button to select a particular option (Contrast, Brightness, Sharpness, Color, or Tint), then press the ENTER button.

Press the ◀ or ▶ button to decrease or increase the value of a particular item.

- You can also select these options (Contrast, Brightness, Sharpness, Color, or Tint) by pressing the ▲ or ▼ button.

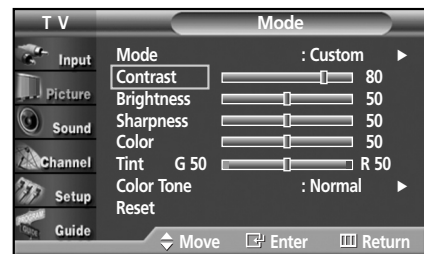

Notes

- "Tint" doesn't operate in PC, HDMI or any Component mode.
- The Tint cannot be adjusted while watching Digital TV.

- 5 Press the ENTER button to return to "Mode".
Press the ▲ or ▼ button to select "Color Tone", then press the ENTER button.

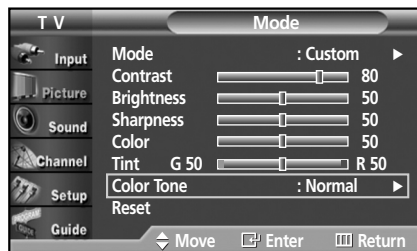

- 6 Press the ▲ or ▼ button to select a particular option (Cool2, Cool1, Normal, Warm1, or Warm2), then press the ENTER button.

Press the EXIT button to exit.

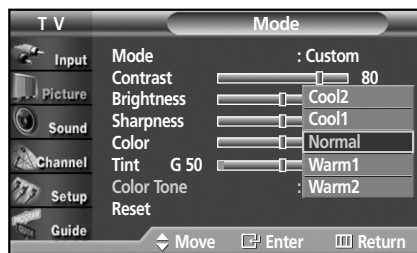

Resetting the Picture Settings to the Factory Defaults

- 7 To return the factory defaults, select "Reset" by pressing the ▲ or ▼ button.
Press the ENTER button.

- The previously adjusted settings will be reset to the factory defaults.

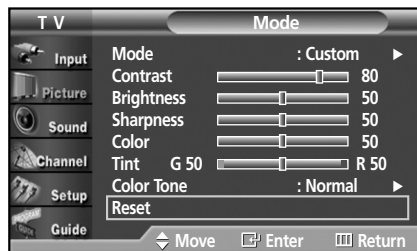

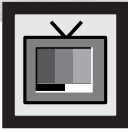

Viewing the DNle Demonstration

This TV includes the DNle function so as to provide a high visual quality.

If you set DNle Demo to On, you can view the applied DNle and normal pictures on the screen for demonstration purposes. Using this function, you can view the difference in the visual quality.

- 1 Press the MENU button. Press the ▲ or ▼ button to select "Picture", then press the ENTER button.

➤ Quick way to select DNle: Just press "DNle" button under the cover of the remote control.

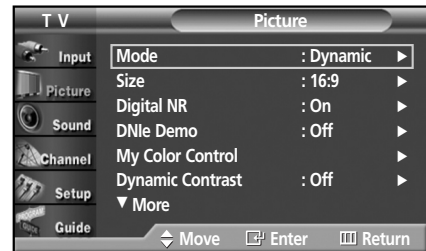

- 2 Press the ▲ or ▼ button to select "DNle Demo", then press the ENTER button.

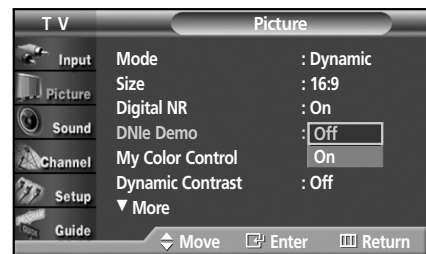

- 3 Press the ▲ or ▼ button to select "Off" or "On", then press the ENTER button.

- Off : Switches off the DNle Demo mode.
- On : Switches on the DNle Demo mode.

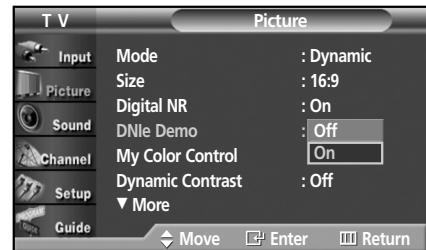

- 4 Press the EXIT button to exit.

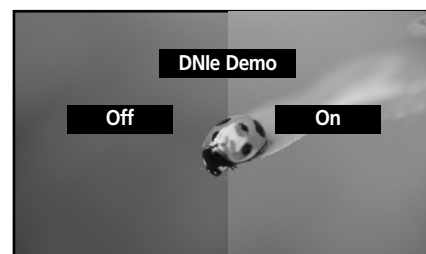

Note

- DNle™ (Digital Natural Image engine) **DNle™**
This feature brings you more a detailed image with 3D noise reduction and detail, contrast and white enhancement.

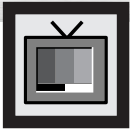

Changing the Screen Size

Screen size selection depends on the type of video input.

1 Press the MENU button. Press the ▲ or ▼ button to select "Picture", then press the ENTER button.

➤ Quick way to change the Screen size: Just press P.SIZE button under the cover of the remote control.

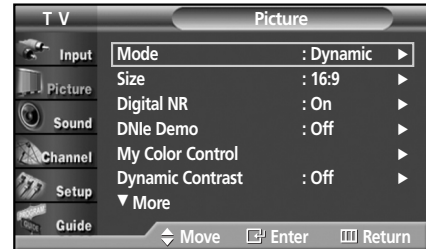

2 Press the ▲ or ▼ button to select "Size", then press the ENTER button.

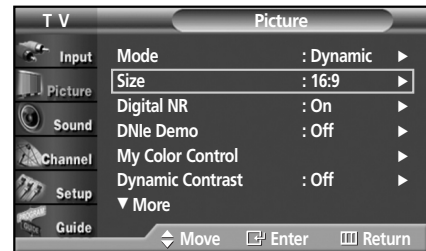

3 Press the ◀ or ▶ button to select the screen size you want, then press the ENTER button.

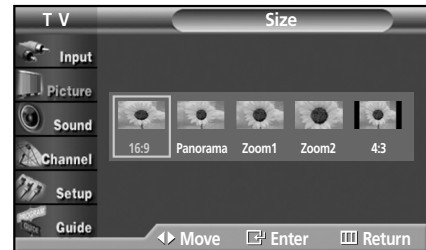

4 Press the EXIT button to exit.

Notes

- Supported screen resolution modes may differ depending on the model of the product.
- If you watch a still image or the 4:3 (Normal) mode for a long time (over 2 hours), an image may be burned onto the screen.
- View the TV in 16:9 (Wide) or Panorama mode as much as possible.
- 16:9 : Sets the picture to 16:9 wide mode.
- Panorama : Use this mode for the wide aspect ratio of a panoramic picture.
- Zoom1 : Magnifies the size of the picture on the screen.
- Zoom2 : Expands the Zoom1 format picture.
- 4:3 : Sets the picture to 4:3 normal mode.

Plasma Display

When you press the P.SIZE button under the cover of the remote control, the TV's screen mode should appear in sequence. The screen displays in this order: 16:9, Panorama, Zoom1, Zoom2, 4:3.

Note

- If you watch a still image or the 4:3 mode for a long time (over 2 hours), an image may be burned onto the screen. View the TV in 16:9 or Panorama mode as much as possible.

16:9

Sets the picture to 16:9 wide mode.

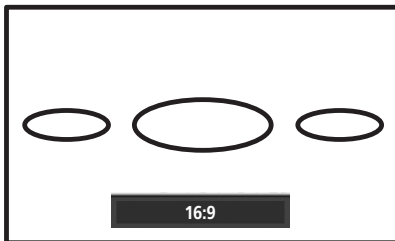

Panorama

Converts regular 4:3 aspect ratio screen to wide screen.

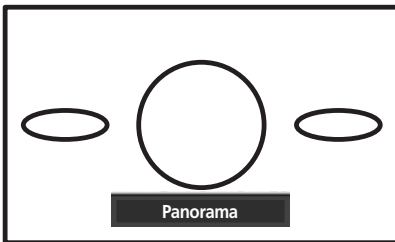

Zoom1

The screen size when Wide screen is vertically enlarged.

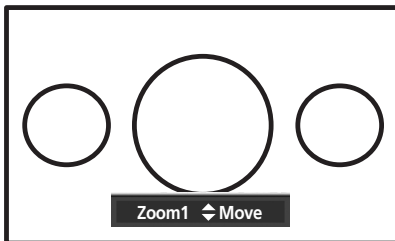

Zoom2

The screen size when the Zoom1 screen is vertically enlarged.

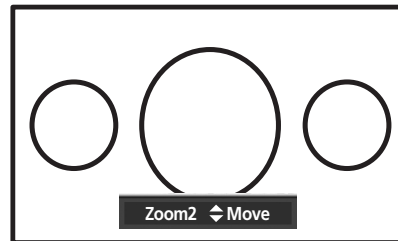

4:3

Sets the picture to 4:3 normal mode.

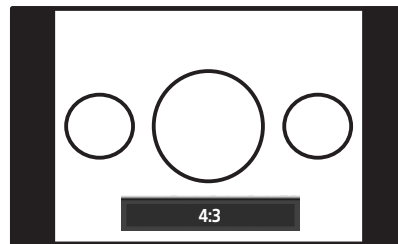

Notes

- In TV, VIDEO, S-VIDEO, and COMPONENT(480i, 480p) modes, all screen modes can be selected. (16:9 → Panorama → Zoom1 → Zoom2 → 4:3).
- In TV(DTV), COMPONENT(720p, 1080i), PC, HDMI modes, only 16:9 & 4:3 modes can be selected.
- In Zoom1, Zoom2 modes, you can move the picture on screen by pressing the ▲ or ▼ button.

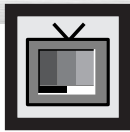

Viewing the Picture-in-Picture

Selecting the PIP Screen

1 Press the MENU button. Press the ▲ or ▼ button to select "Picture", then press the ENTER button.

➤ Quick way to access the PIP mode: Just press "PIP" button under the cover of the remote control.

2 Press the ▲ or ▼ button to select "PIP", then press the ENTER button.

3 Press the ENTER button, then press the ▲ or ▼ button to select "On". The PIP image will appear in the corner of the screen.

- Pressing the ▲ or ▼ button will alternate between "On" and "Off".

Note

- If the PIP On/Off does not function, check if the V-Chip Lock (refer to page 121) is On. PIP does not function when the V-Chip Lock is set to On. Change the setting to Off and try it again.

4 Press the EXIT button to exit.

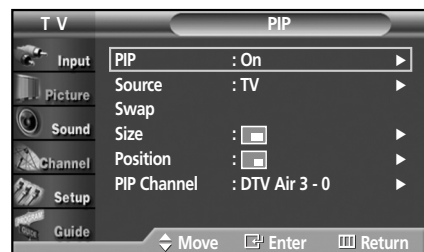
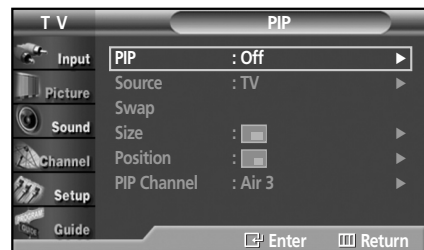
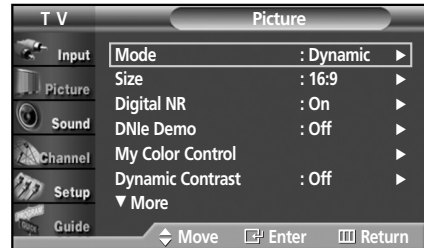

PIP Settings

A : Analog O : PIP and swap operate
D : Digital X : PIP doesn't operate

Main screen \ PIP screen		TV		AV1 (A)	AV2(A)	S-Video1 (A)	S-Video2(A)	Component(A)	PC	HDMI(D)
		Analog	Digital (ATSC/QAM)							
TV	Analog	X		X	X	X	X	X	O	O
	Digital (ATSC/QAM)	X		O	O	O	O	O	X	X
AV1(A)		X	O	X	X	X	X	X	O	O
AV2(A)		X	O	X	X	X	X	X	O	O
S-Video1 (A)		X	O	X	X	X	X	X	O	O
S-Video2(A)		X	O	X	X	X	X	X	O	O
Component(A)		X	O	X	X	X	X	X	O	O
PC		X	X	X	X	X	X	X	X	X
HDMI(D)		O	X	O	O	O	O	O	X	X

Note

- This TV has only one tuner and does not allow you to watch one TV channel in the main screen and another channel in the PIP screen.

Selecting an External Signal

You can use PIP to view a signal from an external source, such as a VCR.

- 1 Press the MENU button. Press the ▲ or ▼ button to select "Picture", then press the ENTER button.

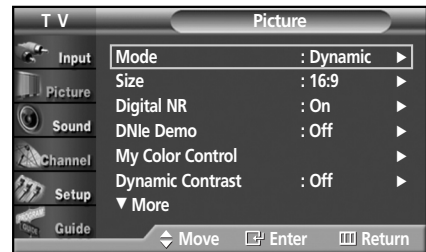

- 2 Press the ▲ or ▼ button to select "PIP", then press the ENTER button.

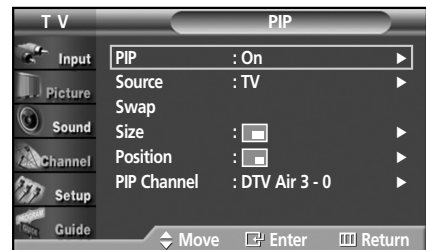

- 3 Press the ▲ or ▼ button to select "Source", then press the ENTER button.

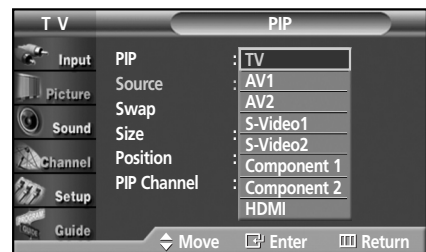

- 4 Press the ▲ or ▼ button to cycle through all of the available signal sources:
"TV", "AV1", "AV2", "S-Video1", "S-Video2",
"Component1", "Component2", or "HDMI".

- The signal from these inputs will not appear if you have not connected any equipment to the TV's respective input jacks.

- 5 Press the EXIT button to exit.

Notes

- The same source cannot be selected on both the main and sub screens.
- PC is not available in PIP picture.

Swapping the Contents of the PIP and Main Image

- 1 Press the MENU button. Press the ▲ or ▼ button to select "Picture", then press the ENTER button.

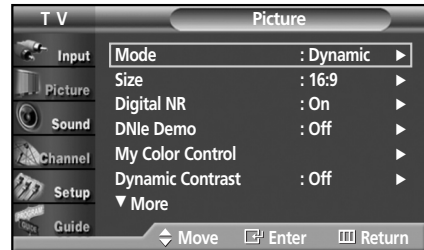

- 2 Press the ▲ or ▼ button to select "PIP", then press the ENTER button.

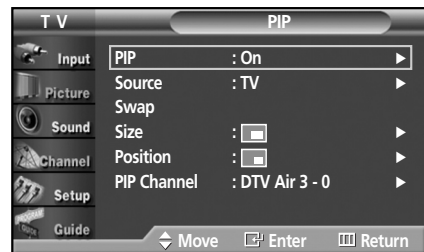

- 3 Press the ▲ or ▼ button to select "Swap", then press the ENTER button.

- The image in the PIP window will appear on the main screen, and vice versa. (Refer to page 56)

Note

- If main picture is in PC mode, Swap is not available.

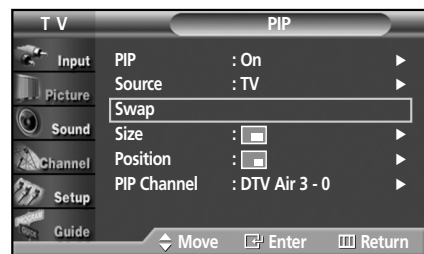

- 4 Press the EXIT button to exit.

Changing the Size of the PIP Window

1 Press the MENU button. Press the ▲ or ▼ button to select "Picture", then press the ENTER button.

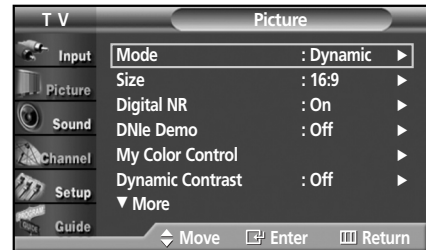

2 Press the ▲ or ▼ button to select "PIP", then press the ENTER button.

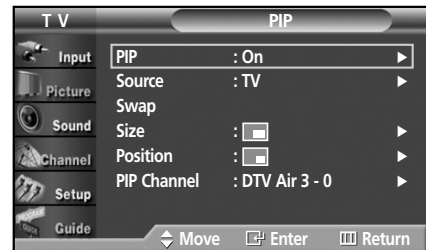

3 Press the ▲ or ▼ button to select "Size", then press the ENTER button.

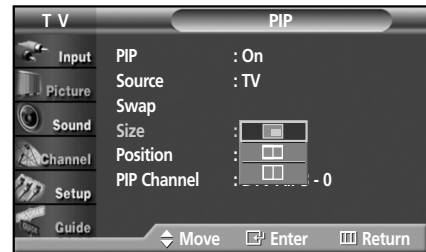

4 Press the ▲ or ▼ button to select option you want, then press the ENTER button.

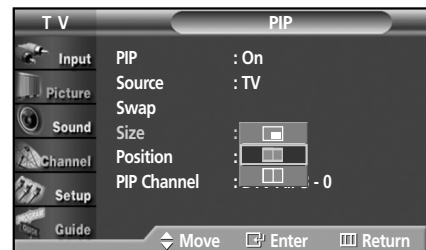

5 Press the EXIT button to exit.

Note

- When the size is Double, the screen is resized and PIP is canceled.

Changing the Location of the PIP Image

- 1 Press the MENU button. Press the ▲ or ▼ button to select "Picture", then press the ENTER button.

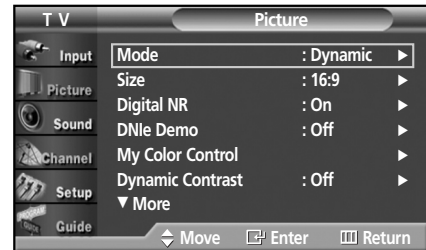

- 2 Press the ▲ or ▼ button to select "PIP", then press the ENTER button.

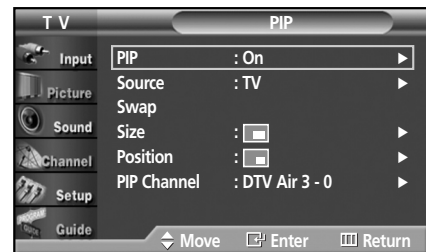

- 3 Press the ▲ or ▼ button to select "Position", then press the ENTER button.

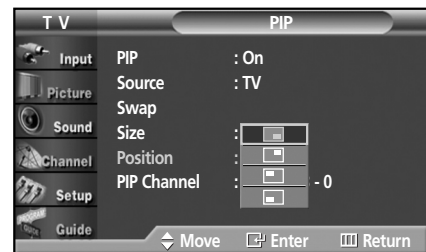

- 4 Press the ▲ or ▼ button to select the PIP position you want, then press the ENTER button.

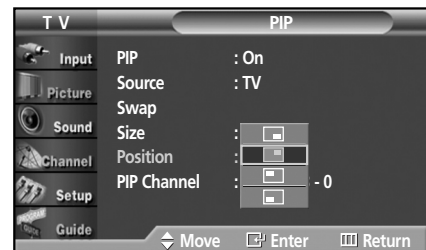

- 5 Press the EXIT button to exit.

Note

- In Double Window (□□) and Double Wide (□□) modes, Position cannot be selected.

Changing the PIP Channel

1 Press the MENU button. Press the ▲ or ▼ button to select "Picture", then press the ENTER button.

➤ Quick way to change the PIP channel: Just press "CH ▲" or "CH ▼" button under the cover of the remote control.

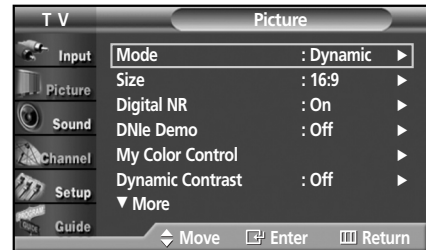

2 Press the ▲ or ▼ button to select "PIP", then press the ENTER button.

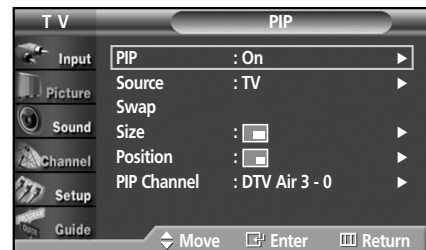

3 Press the ▲ or ▼ button to select "PIP Channel", then press the ENTER button.

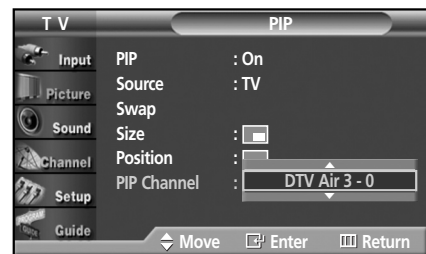

4 Press the ▲ or ▼ button to change the channel that appears in the PIP window.

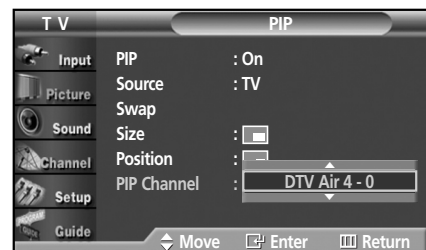

5 Press the EXIT button to exit.

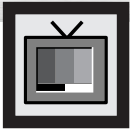

Selecting the Sound Source

You can use this feature to hear sound from the main or sub (PIP) picture.

- 1 Press the MENU button. Press the ▲ or ▼ button to select "Sound", then press the ENTER button.

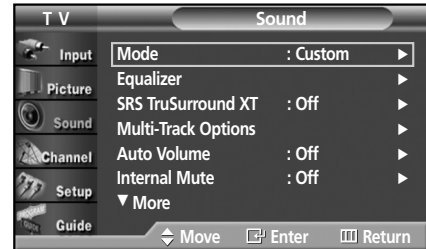

- 2 Press the ▲ or ▼ button to select "Sound Select", then press the ENTER button.

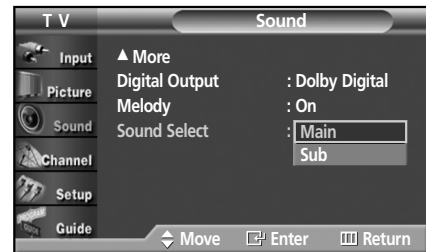

- 3 Press the ▲ or ▼ button to select "Main" or "Sub", then press the ENTER button.

- 4 Press the EXIT button to exit.

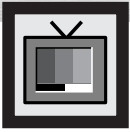

Setting the My Color Control Mode

My Color Control allows you to adjust colors according to your preference, by adjusting skin, sky, and grass tones using the predefined settings (Standard, Custom, Red, Green, Blue, Yellow, Pink, White) without affecting other colors on the screen.

Using the My Color Control Function in the Easy Control Menu

Skin, sky and grass tones are easily adjustable to suit your preferences.

- 1 Press the MENU button. Press the ▲ or ▼ button to select "Picture", then press the ENTER button.

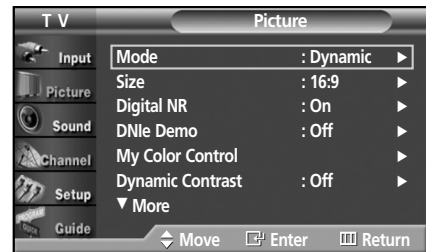

- 2 Press the ▲ or ▼ button to select "My Color Control", then press the ENTER button.

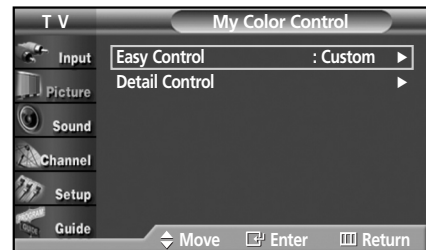

- 3 Press the ENTER button to select "Easy Control".

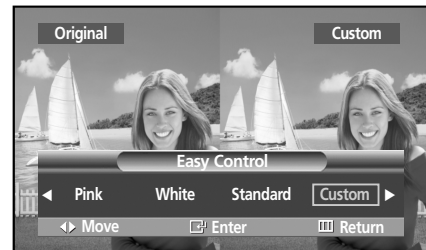

- 4 Press the ◀ or ▶ button to select the setting among the various picture settings. The original picture (before adjustment) is shown on the left side, while the selected mode is shown on the right side.

➤ There are eight My Color Control modes: Standard, Custom, Red, Green, Blue, Yellow, Pink, White.

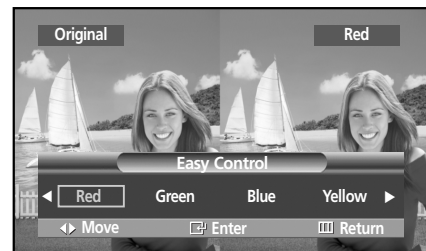

- 5 Press the EXIT button to exit.

Note

- Pressing the ENTER button on the remote control for 3 seconds when there is no OSD on the screen will display the My Color Control menu.
- The My Color Control is not available in PC mode.

My Color Control Mode Characteristics

Using My Color Control mode, you can enjoy vivid colors as shown below.



➤ Standard Picture.

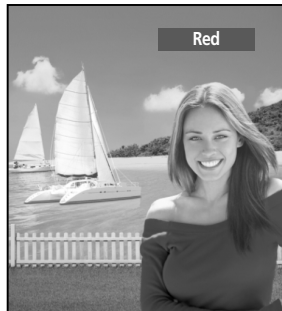

➤ Emphasizes Reds.

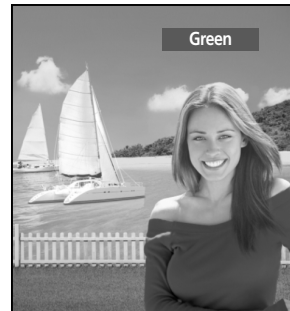

➤ Emphasizes Mild Greens.

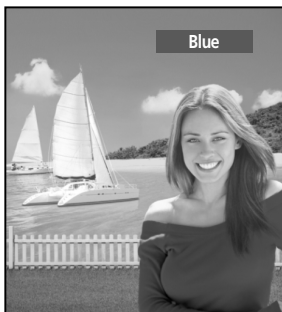

➤ Emphasizes Clear Blues.

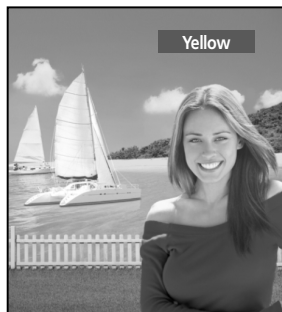

➤ Emphasizes Yellows.

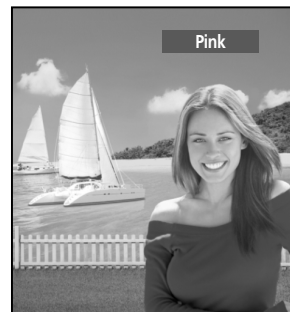

➤ Emphasizes Warm Skin Colors.

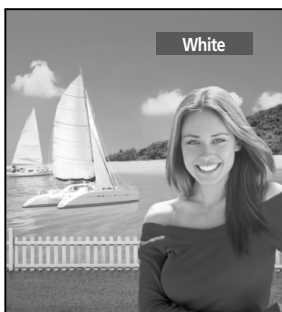

➤ Emphasizes Whites.

Note

- Images shown above may differ from the actual adjustment on the screen. These images are presented for illustrative purposes.

My Color Control Custom Settings

Users can adjust the 6 My Color Control colors (Red, Green, Blue, Yellow, Pink, and White).

- 1 Press the MENU button. Press the ▲ or ▼ button to select "Picture", then press the ENTER button.

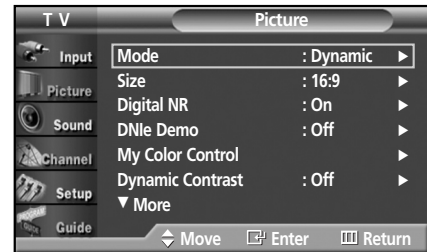

- 2 Press the ▲ or ▼ button to select "My Color Control", then press the ENTER button.

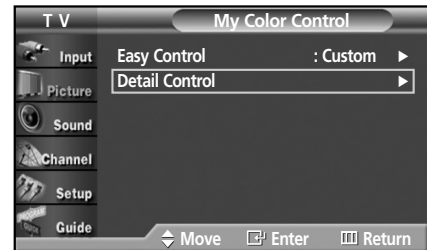

- 3 Press the ▲ or ▼ button to select "Detail Control", then press the ENTER button.



- 4 Press the ▲ or ▼ button to select the desired color and then press the ENTER or ► button.

- The original picture (before adjustment) is shown on the left side, while the picture after adjustment is shown on the right side, and an adjustment bar is shown on the bottom of the screen.

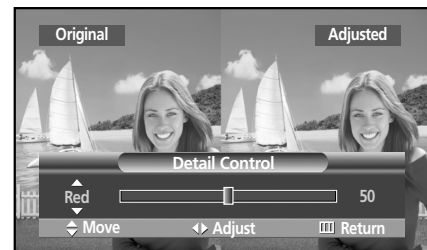

- 5 Press the ◀ or ▶ button to adjust the settings.

- Press the ▲ or ▼ button to select other colors.

- 6 Press the ENTER or MENU button to confirm the changes and return to the previous menu.

Resetting the My Color Control Colors to the Factory Defaults

To return to the factory default settings for My Color Control colors, use the Reset function.

- 1 Press the MENU button. Press the ▲ or ▼ button to select "Picture", then press the ENTER button.

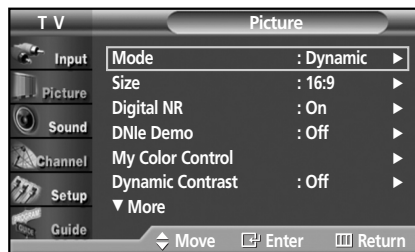

- 2 Press the ▲ or ▼ button to select "My Color Control", then press the ENTER button.

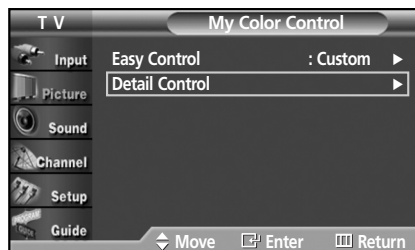

- 3 Press the ▲ or ▼ button to select "Detail Control", then press the ENTER button.

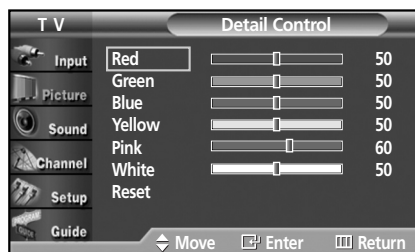

- 4 Press the ▲ or ▼ button to select "Reset" and press the ENTER button.



- 5 The previously adjusted My Color Control Colors will be reset to the factory defaults.

- 6 Press the EXIT button to exit.

P L A S M A D I S P L A Y P A N E L

Sound Control



Customizing the Sound	68
Using Automatic Sound Settings	69
Setting the TruSurround XT	70
Choosing a Multi-Channel Sound (MTS) track - Digital.....	71
Choosing a Multi-Channel Sound (MTS) track - Analog	72
Using the Auto Volume.....	73
Choosing a Digital Sound Format	74
Setting the On/Off Melody	75
Selecting the Internal Mute	76



Customizing the Sound

The sound settings can be adjusted to suit your personal preferences.
(Alternatively, you can use one of the “automatic” settings. See next page.)

- 1 Press the MENU button. Press the ▲ or ▼ button to select “Sound”, then press the ENTER button.

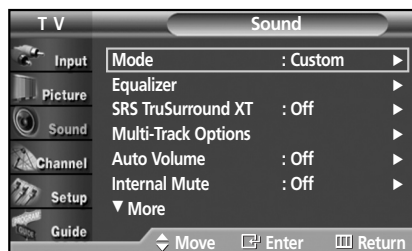

- 2 Press the ▲ or ▼ button to select “Equalizer”, then press the ENTER button.

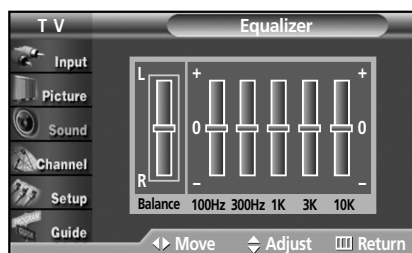

- 3 Press the ◀ or ▶ button to select a particular frequency to adjust. Press the ▲ or ▼ button to increase or decrease the level of the particular frequency.

- 4 Press the EXIT button to exit.

Notes

- If you make any changes to the equalizer settings, the sound mode is automatically switched to the custom mode.
- L/R Sound Balance Adjustment
To adjust the sound balance of the L/R speakers.
- Bandwidth Adjustment (100Hz, 300Hz, 1K, 3K, 10K)
To adjust the level of different bandwidth frequencies.



Using Automatic Sound Settings

Your TV has automatic sound settings ("Standard", "Music", "Movie", and "Speech") that are preset at the factory. Or, you can select "Custom," which automatically recalls your personalized sound settings.

1 Press the MENU button. Press the ▲ or ▼ button to select "Sound", then press the ENTER button.

➤ Quick way to access the picture setting: Just press "S.MODE" button on the remote control.

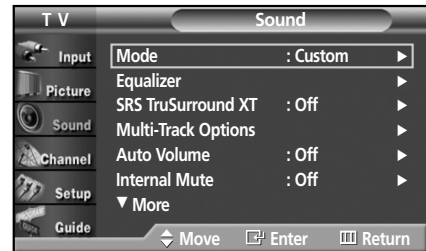

2 Press the ENTER button to select "Mode".

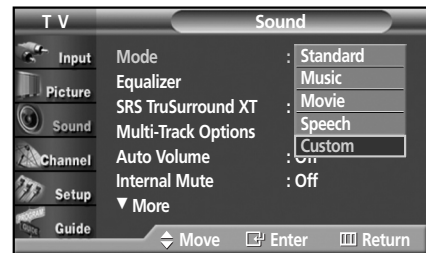

3 Press the ▲ or ▼ button to select "Standard", "Music", "Movie", "Speech", or "Custom" sound setting, then press the ENTER button.

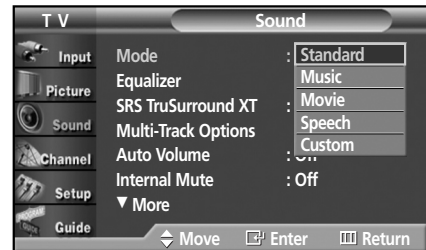

4 Press the EXIT button to exit.

- Choose Standard for the standard factory settings.
- Choose Music when watching music videos or concerts.
- Choose Movie when watching movies.
- Choose Speech when watching a show that is mostly dialog (i.e., news).
- Choose Custom to recall your personalized settings (see "Customizing the Sound", page 68).



Setting the TruSurround XT

TruSurround XT is a patented SRS technology that solves the problem of playing 5.1 multichannel content over two speakers. TruSurround delivers a compelling, virtual surround sound experience through any two-speaker playback system, including internal television speakers. It is fully compatible with all multichannel formats.

- 1 Press the MENU button. Press the ▲ or ▼ button to select "Sound", then press the ENTER button.

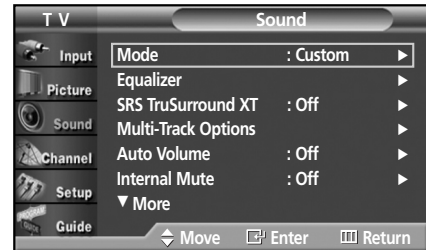

- 2 Press the ▲ or ▼ button to select "SRS TruSurround XT", then press the ENTER button.

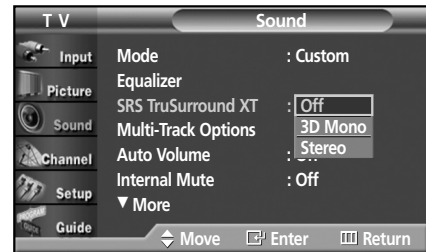

- 3 Press the ▲ or ▼ button to change the setting (Off, 3D Mono, or Stereo), then press the ENTER button.

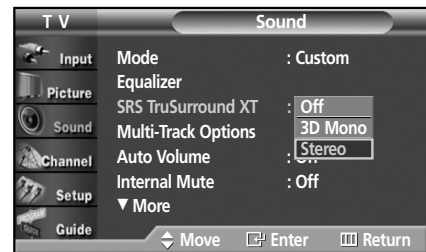

- 4 Press the EXIT button to exit.



Choosing a Multi-Channel Sound (MTS) track - Digital

The digital-TV transmission system is capable of simultaneous transmission of many audio tracks (for example, simultaneous translations of the program into foreign languages). The availability of these additional "multitracks" depends upon the program.

1 Press the MENU button. Press the ▲ or ▼ button to select "Sound", then press the ENTER button.

➤ Quick way to access the MTS menu: Just press "MTS" button under the cover of the remote control. You can listen in a language other than the favorite language by pressing the MTS button.

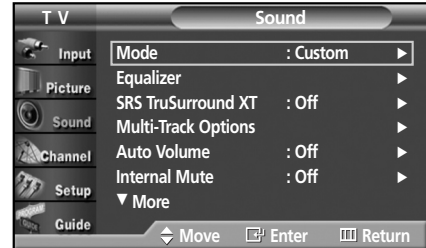

2 Press the ▲ or ▼ button to select "Multi-Track Options", then press the ENTER button.



3 Press the ENTER button to select "Preferred Language". Press the ▲ or ▼ button to choose the language (English, Spanish, or French) you want, then press the ENTER button.



4 Press the EXIT button to exit.

Note

- You can only select the language from among the actual languages broadcast by the station. For example, if the current program is not broadcast in French, yet you select French as your Preferred language, you will hear the default language (e.g. English) determined by the broadcasting station.



Choosing a Multi-Channel Sound (MTS) track - Analog

Depending on the particular program being broadcast, you can listen to Mono, Stereo or SAP.

1 Press the MENU button. Press the ▲ or ▼ button to select "Sound", then press the ENTER button.

➤ Quick way to access the MTS menu: Just press "MTS" button under the cover of the remote control repeatedly to select one of the settings.

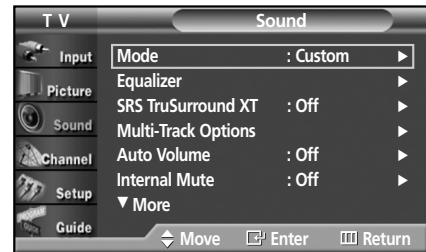

2 Press the ▲ or ▼ button to select "Multi-Track Options", then press the ENTER button.



3 Press the ENTER button to select "Multi-Track Sound". Press the ▲ or ▼ button to select a setting you want, then press the ENTER button.



4 Press the EXIT button to exit.

- Choose "Mono" for channels that are broadcasting in mono, or if you are having difficulty receiving a stereo signal.
- Choose "Stereo" for channels that are broadcasting in stereo.
- Choose "SAP" to listen to the Separate Audio Program, which is usually a foreign-language translation.



Using the Auto Volume

Each broadcasting station has its own signal conditions, which can make it necessary to adjust the volume every time the channel is changed. "Auto Volume" lets you automatically adjust the volume of the desired channel by lowering the sound output when the modulation signal is high or by raising the sound output when the modulation signal is low.

- 1 Press the MENU button. Press the ▲ or ▼ button to select "Sound", then press the ENTER button.

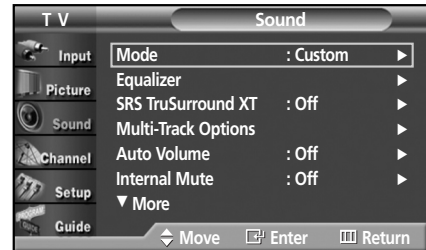

- 2 Press the ▲ or ▼ button to select "Auto Volume", then press the ENTER button.

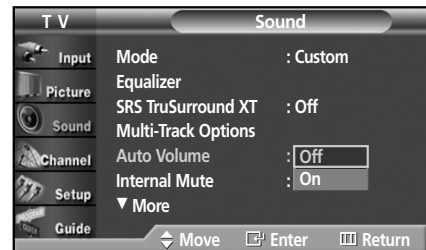

- 3 Press the ▲ or ▼ button to select "On", then press the ENTER button.

- Pressing the ▲ or ▼ button will alternate between "On" and "Off".

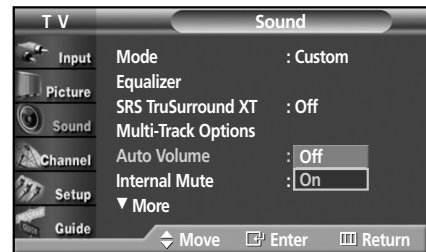

- 4 Press the EXIT button to exit.



Choosing a Digital Sound Format

Digital sound can be output from the rear panel connector on your TV. The digital sound outputs are connectors labeled "Optical" and "Coaxial". After connecting a digital-audio component, you must specify the transmission format (Dolby or PCM, as appropriate to your digital audio component).

- 1 Press the MENU button. Press the ▲ or ▼ button to select "Sound", then press the ENTER button.

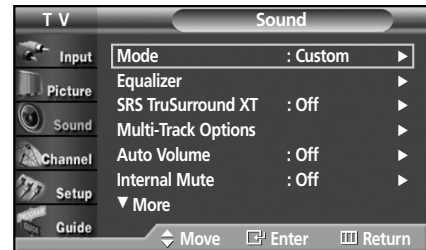

- 2 Press the ▲ or ▼ button to select "Digital Output", then press the ENTER button. Press the ▲ or ▼ button to select "Dolby Digital" or "PCM", then press the ENTER button.

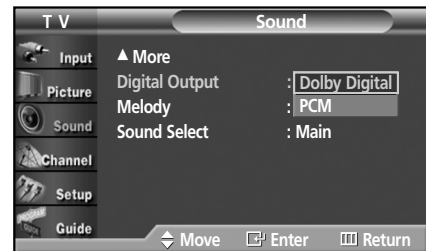

- 3 Press the EXIT button to exit.

Note

- In Digital TV mode, both Dolby Digital and PCM can be selected, while only PCM can be selected in HDMI mode.



Manufactured under license from Dolby Laboratories.
"Dolby" and the double-D symbol are trademarks of Dolby Laboratories.



Setting the On/Off Melody

A melody sound can be set to come on when the TV is powered on or off.

- 1 Press the MENU button. Press the ▲ or ▼ button to select "Sound", then press the ENTER button.

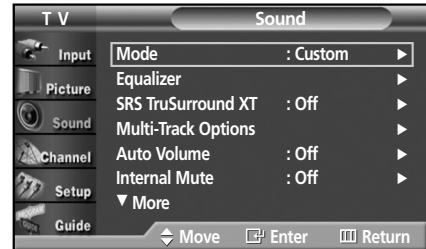

- 2 Press the ▲ or ▼ button to select "Melody", then press the ENTER button. Press the ▲ or ▼ button to select "On" or "Off", then press the ENTER button.

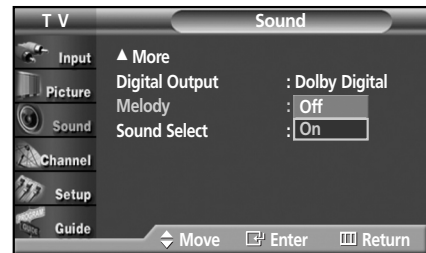

- 3 Press the EXIT button to exit.



Selecting the Internal Mute

Sound output from the TV speakers is muted.

- 1 Press the MENU button. Press the ▲ or ▼ button to select "Sound", then press the ENTER button.

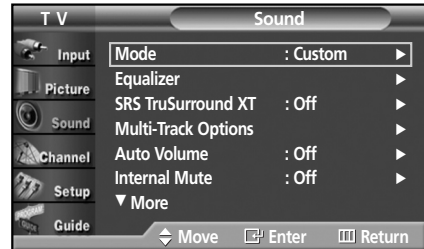

- 2 Press the ▲ or ▼ button to select "Internal Mute", then press the ENTER button.

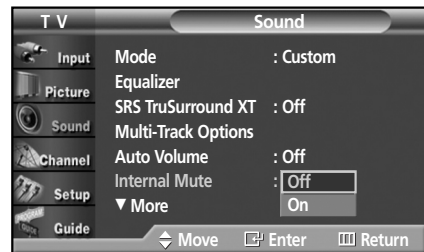

- 3 Press the ▲ or ▼ button to select "On", then press the ENTER button.

- Pressing the ▲ or ▼ button will alternate between "On" and "Off".



- 4 Press the EXIT button to exit.

Notes

- When Internal Mute is set to "On", Sound menus except Multi-track Options, Digital Output cannot be adjusted.
- The monitor and digital audio outputs (Optical, Coaxial) remain enabled.
- The VOL +, VOL - and Mute buttons do not operate when the Internal Mute is set to On.
- When Internal Mute is ON, only MTS is selectable for the Sound.

P L A S M A D I S P L A Y P A N E L

Channel Control

Selecting the Antenna	78
Selecting Your Favorite Channels	79
Labeling the Channels	80
Viewing the Channel Lists.....	81
Editing the Channel Lists	82
Fine Tuning Analog Channels	83
Checking the Digital-Signal Strength	84
LNA (Low Noise Amplifier)	85



Selecting the Antenna

- 1 Press the MENU button. Press the ▲ or ▼ button to select "Channel", then press the ENTER button.



- 2 Press the ENTER button to select "Antenna". Press the ▲ or ▼ button to select "Air" or "Cable", then press the ENTER button.

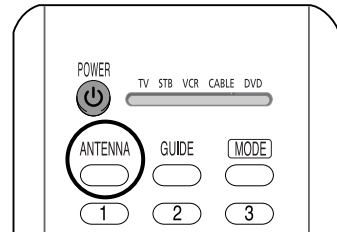

Notes

- If the antenna is connected to ANT 1 IN (CABLE IN), select "CABLE" and if it is connected to ANT 2 IN (AIR IN), select "Air".
- If both ANT 1 IN and ANT 2 IN are connected, select the antenna input you want. If the antenna input is not selected properly, noise may appear on the screen.

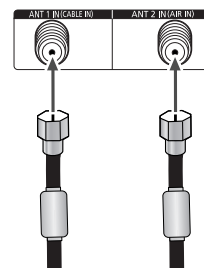
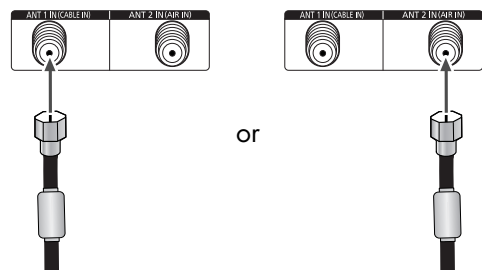



Selecting Your Favorite Channels

You can store your favorite channels for each available input source (such as TV and Cable box). Then, when you press the FAV.CH button on the remote control, the TV displays only the favorite channels you previously stored, allowing you to quickly and easily find frequently watched channels.

To Store Your Favorite Channels:

- 1 Press the MENU button.
Press the ▲ or ▼ button to select "Channel", then press the ENTER button.



- 2 Press the ▲ or ▼ button to select "Favorite Channels", then press the ENTER button.

Press the ▲ or ▼ button to select a channel as a favorite channel, then press the ENTER button. Press the ENTER button again to deselect the selected channel.



- 3 Press the EXIT button to exit.



Notes

- Only memorized channels can be set as favorite channels.
- Select All : Press to select all channels.
Clear All : Press to clear all channels.

To View Your Favorite Channels:

Press the FAV.CH button repeatedly to jump from one favorite channel to another.

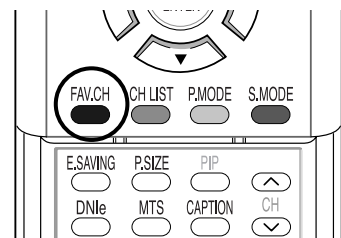

CH

Labeling the Channels

Use this feature to assign an easy-to-remember label to any channel (i.e., "CBS", "ESPN", "PBS2", "CNN1", etc.) A label consists of five fields, where each field is a letter, a number or a blank. When the INFO button is pressed, the channel label will appear next to the channel number.

- 1 Press the MENU button.
Press the ▲ or ▼ button to select "Channel", then press the ENTER button.



- 2 Press the ▲ or ▼ button to select "Name", then press the ENTER button.

Press the ▲ or ▼ button to select the channel to be assigned to a new name, then press the ENTER button.

Press the ▲ or ▼ button to select a letter, a number or a blank (Results in this sequence: A...Z, 0...9, +, -, *, /, blank).

Press the ► button to switch to the next field, which will be selected.

Select a second letter or digit by pressing the ▲ or ▼ button, as above.

Repeat the process to select the last three digits.

When you have finished, press the ENTER button to assign the new name.

- To clear the entered channel name, move to "Clear" by using the ◀/▶ button and press ENTER.

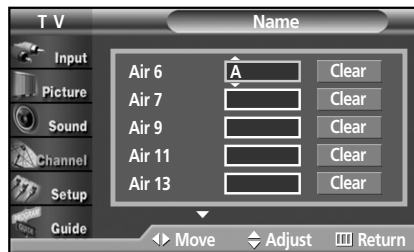
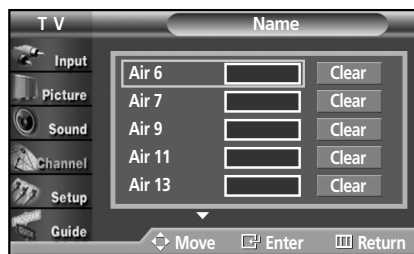

- 3 Press the EXIT button to exit.

Note

- The names of digital broadcasting channels are automatically assigned and thus cannot be assigned by users.



Viewing the Channel Lists

You can display a list of all channels or your favorite channels.

- 1 Press the MENU button.
Press the ▲ or ▼ button to select "Channel", then press the ENTER button.
 - Quick way to view the Channel Lists: Just press "CH LIST" button on the remote control.



- 2 Press the ▲ or ▼ button to select "Channel List", then press the ENTER button.

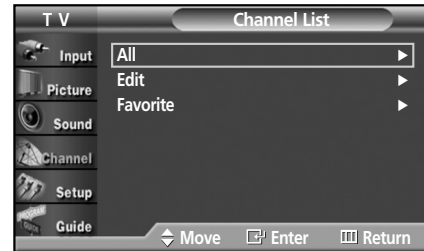

- 3 Press the ▲ or ▼ button to select "All" or "Favorite", then press the ENTER button.
To toggle between your favorite channels or all channels, use the yellow button on the remote control.

- Red button : Press to display the previous channel list page.
- Green button : Press to display the next channel list page.
- Yellow button : Press to toggle between your favorite channels or all channels.
- Blue or EXIT button : Press to exit.

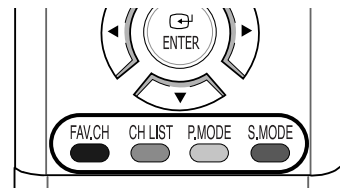
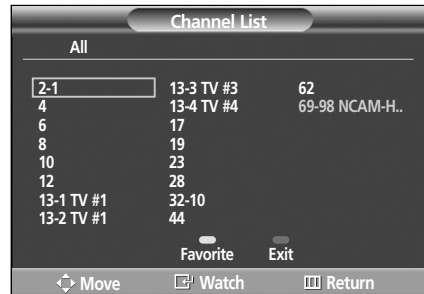

Alternate method :

Press the CH LIST button on the remote control to display a list of channels.

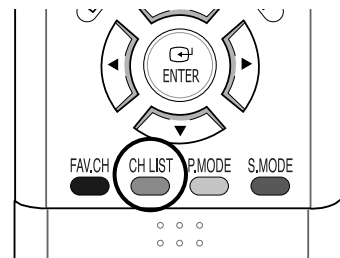



Editing the Channel Lists

You can edit channels to be added or deleted.

- 1 Press the MENU button.
Press the ▲ or ▼ button to select "Channel", then press the ENTER button.

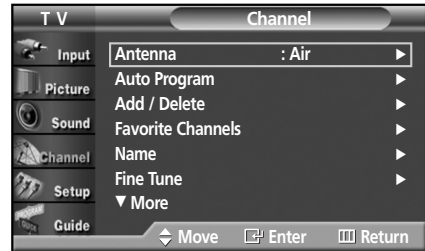

- 2 Press the ▲ or ▼ button to select "Channel List", then press the ENTER button.

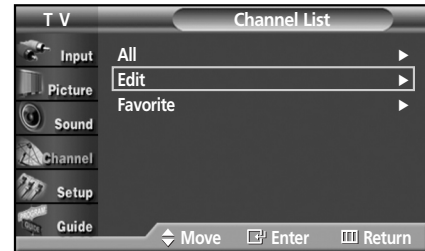

- 3 Press the ▲ or ▼ button to select "Edit", then press the ENTER button.

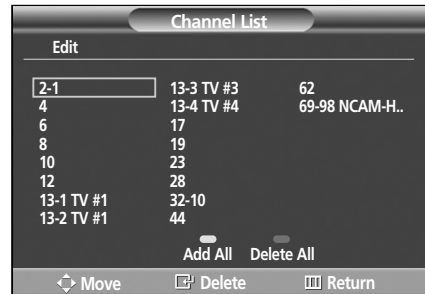

- 4 Press the ▲ or ▼ button to select Channel and the ENTER button. Then, the channel can be deleted or added. The deleted channel will be dim in the channel list.

- Red button : Press to display the previous channel list page.
- Green button : Press to display the next channel list page.
- Yellow button : Press to add all channels deleted.
- Blue button : Press to delete all channels memorized.

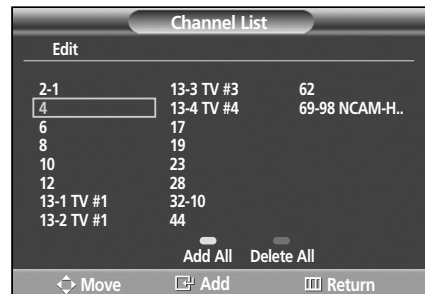

- 5 Press the EXIT button to exit.

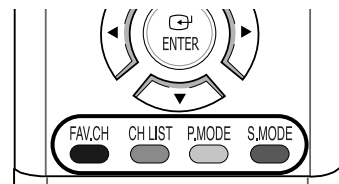

CH

Fine Tuning Analog Channels

Use fine tuning to manually adjust a particular channel for optimal reception.

- 1 Press the MENU button. Press the ▲ or ▼ button to select "Channel", then press the ENTER button.



- 2 Press the ▲ or ▼ button to select "Fine Tune", then press the ENTER button.



- 3 Press the ◀ or ▶ button to adjust the fine tuning. To store the fine tuning setting in the TV's memory, press the ENTER button.



- 4 To reset the fine tuning setting, press the ▼ button to select "Reset", then press the ENTER button.

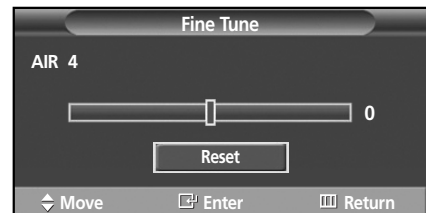

- 5 Press the EXIT button to exit.

Notes

- Only analog TV channels can be fine tuned.
- "*" will appear next to the name of fine-tuned channels.

CH

Checking the Digital-Signal Strength

Unlike analog channels, which can vary in reception quality from “snowy” to clear, digital (HDTV) channels have either perfect reception quality or you will not receive them at all. So, unlike analog channels, you cannot fine tune a digital channel. You can, however, adjust your antenna to improve the reception of available digital channels.

- 1 Press the MENU button.
Press the ▲ or ▼ button to select “Channel”, then press the ENTER button.



- 2 Press the ▲ or ▼ button to select “Signal Strength”, then press the ENTER button.

If the signal strength meter indicates that the signal is weak, physically adjust your antenna to increase the signal strength.

Continue to adjust the antenna until you find the best position with the strongest signal.

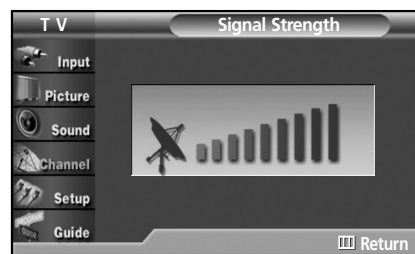

- 3 Press the EXIT button to exit.

CH

LNA (Low Noise Amplifier)

If the TV is operating in a weak-signal area, sometimes the LNA function can improve the reception (a low-noise preamplifier boosts the incoming signal).

- 1 Press the MENU button. Press the ▲ or ▼ button to select "Channel", then press the ENTER button.



- 2 Press the ▲ or ▼ button to select "LNA", then press the ENTER button.



- 3 Press the ▲ or ▼ button to select "On" or "Off", then press the ENTER button.



- 4 Press the EXIT button to exit.

Notes

- LNA functions only when antenna is set to AIR. (See "Selecting the Antenna" on page 78.)
- If the picture is noisy with the LNA set to On, select Off.
- The LNA setting must be made separately for each channel.

P L A S M A D I S P L A Y P A N E L

Connecting a PC and Operation



Connecting a PC.....	88
Changing the Position of the Image.....	92
Picture Quality Adjustment	93
Image Reset	96



Connecting a PC

Connection to a Macintosh computer may require an adapter.

TV Rear Panel

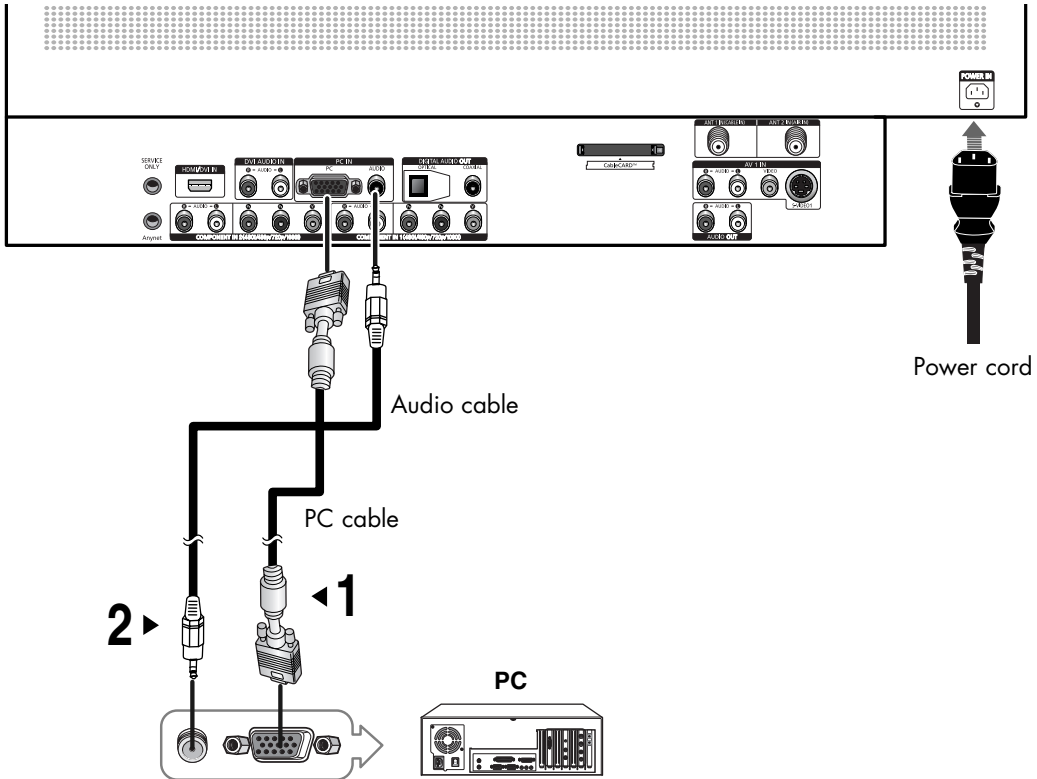

Connecting a PC (15p D-SUB) to the TV

- 1 Connect a PC cable between the PC Output jack on the PC and the RGB input jack (PC IN) on the TV.
- 2 Connect a Audio cable between the Audio jack on the PC and the Audio input jacks (PC AUDIO IN) on the TV.

Notes

- Please be sure to match the color coded input terminals and cable jacks.
- A PC will not operate when connected with a HDMI/DVI cable.

To watch the PC screen:

1. Turn on your TV.
2. Press the SOURCE button on the remote control or SOURCE button on the side panel to select "PC".
3. Turn on your PC and check for PC system requirements. (Refer to pages 90 and 91 for PC system requirements.)
4. Adjust the PC screen. (Refer to pages 92 to 95)

Setting up Your TV (Plug and Play)

Our adoption of the new VESA® Plug and Play solution eliminates complicated and time consuming setup. It allows you to install your monitor in a Plug and Play compatible system, without the usual setup hassles and confusion. Your PC system can easily identify and configure itself for use with your TV. This TV automatically tells the PC system its Extended Display Identification data (EDID) using Display Data Channel (DDC) protocols.

How to Set up Your PC Software (Windows only)

The Windows display-settings for a typical computer are shown below. But the actual screens on your PC will probably be different, depending upon your particular version of Windows and your particular video card. But even if your actual screens look different, the same, basic set-up information will apply in almost all cases. (If not, contact your computer manufacturer or Samsung Dealer.)



2

3



4

5

1. Right click the mouse on the Windows Desktop, then click on Properties. The Display Dialog-Box will be displayed.
2. Click on Settings, then set the Display Mode with reference to the Display Modes Table. You do not need to change the Colors settings.
3. Click on Advanced. A new settings dialog box will be displayed.
4. Click on the Monitor tab, then set the Screen Refresh Rate with reference to the Display Modes Table. Set the Vertical Frequency and Horizontal Frequency individually if you can do so instead of setting the Screen Refresh Rate.
5. Press the OK button, close the window, then press the OK button on the Display Registration Information window. Automatic re-booting may commence at this moment.
6. Shutdown the PC, and connect it to your TV. (See page 88)

- The actual screens on your PC may look different, depending on your particular version of Windows and the type of your PC.
- When you use your TV as a PC monitor, it supports Colors up to 32 bits.
- In this case, the display on the TV may look different depending on your particular version of Windows or the PC manufacturer.
- When connecting a PC you must set it to the display settings that are supported by the TV. Otherwise, the message "Out of input range" will be displayed.

Continued...

Plasma Display

Note

Both screen position and size will vary, depending on the type of PC monitor and its resolution. The table below shows all of the display modes that are supported:

Video Signal	Resolution (Dot X Line)	Vertical Frequency (Hz)	Horizontal Frequency (KHz)	Vertical Polarity	Horizontal Polarity	
IBM PC / AT Compatible	640 X 350	70.086	31.469	P	N	
	720 X 400	70.087	31.469	N	P	
	640 X 480	70.000	31.469	31.469	N	N
			35.000	35.000	N/P	N/P
			37.861	37.861	N	N
			37.500	37.500	N	N
	800 X 600	70.000	35.156	35.156	N/P	N/P
			37.879	37.879	P	P
			43.750	43.750	N/P	N/P
			48.077	48.077	P	P
			46.875	46.875	P	P
	1024 X 768	70.000	48.363	48.363	N	N
			56.476	56.476	N	N
			57.672	57.672	N/P	N/P
			60.023	60.023	P	P
	1280 X 720	59.855	44.772	44.772	P	N
	1360 X 768	60.015	47.712	47.712	P	P

- The interlace mode is not supported.
- The TV operates abnormally if a non-standard video format is selected.
- The table above conforms to IBM/VESA regulations and is based on using the Analog Input.

Notes

- The PC text quality is optimum in WXGA mode (1360 x 768@60Hz).
- When this TV is used as a PC display, 32-bit color is supported.
- Depending on the manufacturer, your PC display screen might appear different. (and depending on your particular version of Windows.)
Check your PC instruction book for information about connecting your PC to a TV.
- If a vertical and horizontal frequency-select mode exists, select 60Hz (vertical) and 48.4KHz (horizontal).
- In some cases, abnormal signals (such as stripes) might appear on the TV screen when the PC power is turned off (or if the PC is disconnected). If so, press the SOURCE button on the remote control or SOURCE button on the front panel to enter the VIDEO mode. Also, make sure that the PC is connected.



Changing the Position of the Image

After connecting the TV to your PC, adjust the position of the screen if it is not well-aligned.

Preset:

- Press the SOURCE button to select "PC."

1 Press the MENU button. Press the ▲ or ▼ button to select "Setup", then press the ENTER button.



2 Press the ▲ or ▼ button to select "PC", then press the ENTER button.

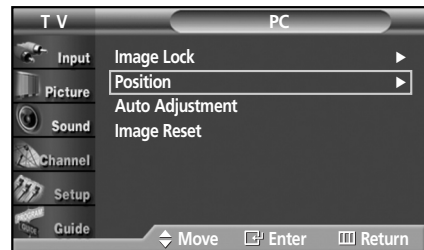

3 Press the ▲ or ▼ button to select "Position", then press the ENTER button.

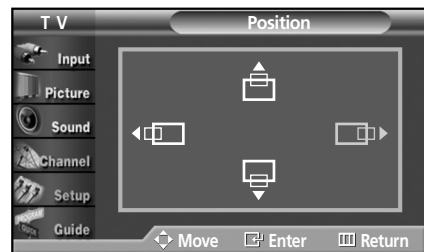

4 Adjust the position of screen by pressing the ▲/▼/◀/▶ button.

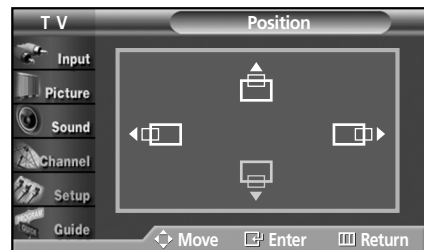

5 Press the EXIT button to exit.



Picture Quality Adjustment

Picture Automatic Adjustment

Preset:

- Press the SOURCE button to select "PC".

1 Press the MENU button. Press the ▲ or ▼ button to select "Setup", then press the ENTER button.



2 Press the ▲ or ▼ button to select "PC", then press the ENTER button.

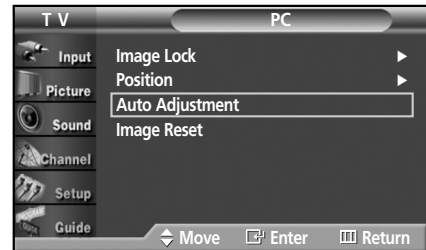

3 Press the ▲ or ▼ button to select "Auto Adjustment", then press the ENTER button. The message "Auto Adjustment in progress. Please wait." appears on the screen and the picture adjustments are automatically activated.

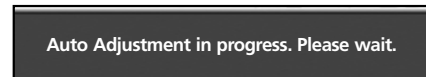

Coarse Adjustment

Preset:

- Press the SOURCE button to select "PC".

1 Press the MENU button. Press the ▲ or ▼ button to select "Setup", then press the ENTER button.

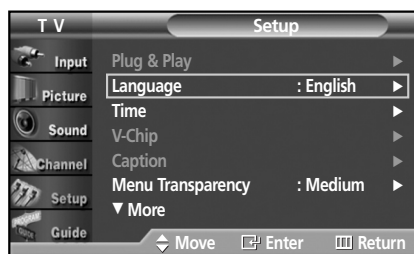

2 Press the ▲ or ▼ button to select "PC", then press the ENTER button.



3 Press the ENTER button to select "Image Lock".

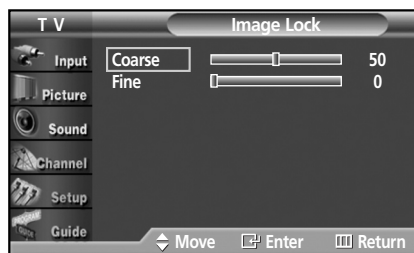

4 Press the ENTER button again to select "Coarse". Remove picture noise (vertical stripes) on the screen by pressing the ◀ or ▶ button. (If Coarse is not set properly, vertical stripes will appear on the screen.)

- Press the ▲ or ▼ button to select another item.

5 Press the EXIT button to exit.

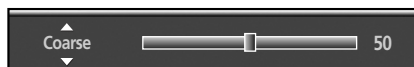

Fine Tuning (Fine)

Preset:

- Press the SOURCE button to select "PC".

- 1 Press the MENU button. Press the ▲ or ▼ button to select "Setup", then press the ENTER button.



- 2 Press the ▲ or ▼ button to select "PC", then press the ENTER button.

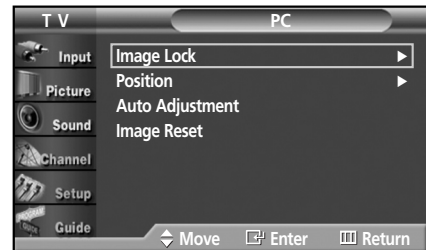

- 3 Press the ENTER button to select "Image Lock".

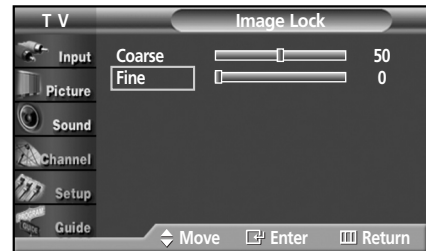

- 4 Press the ▲ or ▼ button to select "Fine", then press the ENTER button.
Remove picture noise on the screen by pressing the ◀ or ▶ button. (If Fine is not set properly, noise will appear on the screen.)

- Press the ▲ or ▼ button to select another item.

- 5 Press the EXIT button to exit.





Image Reset

Preset:

- Press the SOURCE button to select "PC".

1 Press the MENU button. Press the ▲ or ▼ button to select "Setup", then press the ENTER button.



2 Press the ▲ or ▼ button to select "PC", then press the ENTER button.

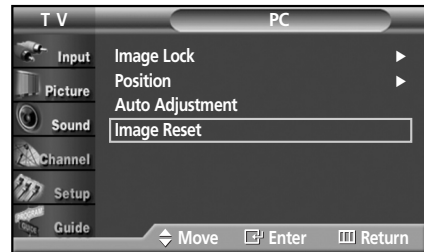

3 Press the ▲ or ▼ button to select "Image Reset", then press the ENTER button. The message "Image Reset is completed." appears on the screen.

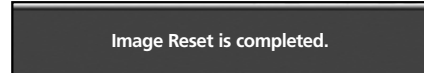

- The previously adjusted settings will be reset to the factory defaults.

P L A S M A D I S P L A Y P A N E L

Time Setting



Setting the Clock.....	98
Setting the On/Off Timer	100
Setting the Sleep Timer	101



Setting the Clock

Setting the clock is necessary in order to use the various timer features of the TV. Also, you can check the time while watching the TV. (Just press the INFO button.)

Option 1: Setting the Clock Manually

1 Press the MENU button. Press the ▲ or ▼ button to select "Setup", then press the ENTER button.



2 Press the ▲ or ▼ button to select "Time", then press the ENTER button. Press the ENTER button to select "Clock".



3 Press the ENTER button to select "Clock Mode". Press the ▲ or ▼ button to select "Manual", then press the ENTER button.



4 Press the ▲ or ▼ button to select "Clock Set", then press the ENTER button.

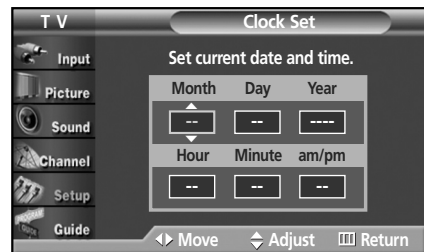

5 Press the ◀ or ▶ button to move to "Month", "Day", "Year", "Hour", "Minute", or "am/pm". Set the clock you want by pressing the ▲ or ▼ button, then press the ENTER button.

6 Press the EXIT button to exit.

Notes

- The current time will appear every time you press the INFO button.
- You can set the Month, Day, Year, Hour and Minute directly by pressing the number buttons on the remote control.

Option 2: Setting the Clock Automatically

The Clock can be set automatically if you are receiving a digital signal.

- 1 Press the MENU button.
Press the ▲ or ▼ button to select "Setup", then press the ENTER button.



- 2 Press the ▲ or ▼ button to select "Time", then press the ENTER button.
Press the ENTER button to select "Clock".

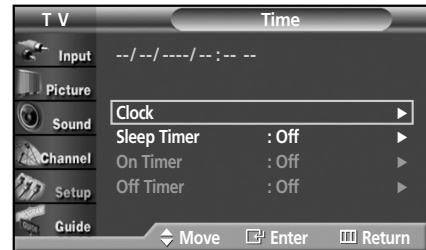

- 3 Press the ENTER button to select "Clock Mode".
Press the ▲ or ▼ button to select "Auto", then press the ENTER button.



- 4 Press the ▲ or ▼ button to select "Time Zone", then press the ENTER button.

Press the ▲ or ▼ button to highlight the time zone for your local area (and to move the highlight to the appropriate time zone on the map of the United States), then press the enter button.



- 5 Press the ▲ or ▼ button to select "DST" (Daylight Saving Time), then press the ENTER button.
Press the ▲ or ▼ button to select "Yes" or "No", then press the ENTER button.

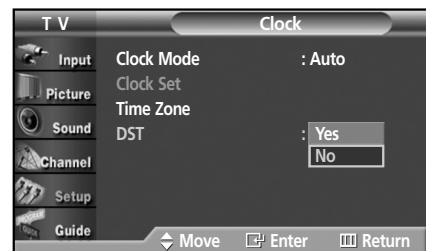

- 6 Press the EXIT button to exit.

Note

- Depending on the broadcast station and signal, the auto time may not be set correctly. If this occurs, set the time manually.



Setting the On/Off Timer

- 1 Press the MENU button.
Press the ▲ or ▼ button to select "Setup", then press the ENTER button.



- 2 Press the ▲ or ▼ button to select "Time", then press the ENTER button.

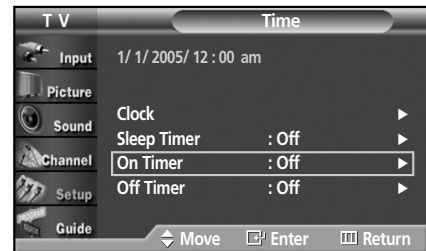

Press the ▲ or ▼ button to select "On Timer", then press the ENTER button.
Press the ▲ or ▼ button to adjust "Hour", then press the ► button to move to the next step.
Set other items using the same method as above.

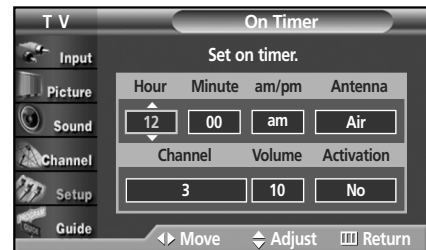

To activate "On Timer" with the setting entered, set Activation to "Yes" by pressing ▲ or ▼ button.

When finished, press the MENU button to return.

- The current time will appear every time you press the INFO button.
- You can set the hour and minute directly by pressing the number buttons on the remote control.

- 3 Press the ▲ or ▼ button to select "Off Timer", then press the ENTER button.

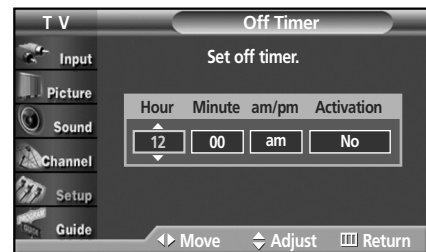

Press the ▲ or ▼ button to adjust "Hour", then press the ► button to move to the next step.
Set other items using the same method as above.

To activate "Off Timer" with the setting entered, set Activation to "Yes" by pressing ▲ or ▼ button.

When finished, press the ENTER button.

- 4 Press the EXIT button to exit.

Note

• Auto Power Off

When you set the timer "On", the television will eventually turn off, if no controls are operated for 3 hours after the TV was turned on by the timer.

This function is only available in timer "On" mode and prevents overheating or leakage, which may occur if a TV is on for too long (when you are on vacation, for example).



Setting the Sleep Timer

The sleep timer automatically shuts off the TV after a preset time (from 30 to 180 minutes).

- 1 Press the MENU button. Press the ▲ or ▼ button to select "Setup", then press the ENTER button.



- 2 Press the ▲ or ▼ button to select "Time", then press the ENTER button.

Press the ▲ or ▼ button to select "Sleep Timer", then press the ENTER button.

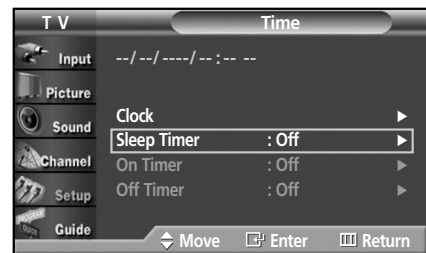

- 3 Press the ▲ or ▼ button to adjust "Minute".
 - Setting the Timer sets the Activation to "Yes" automatically.

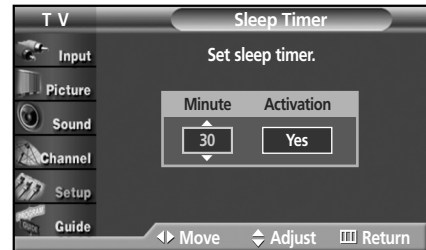

- 4 To cancel the set sleep timer: Press the ► button to select "Activation". Press the ▲ or ▼ button to select "No", then press the ENTER button.

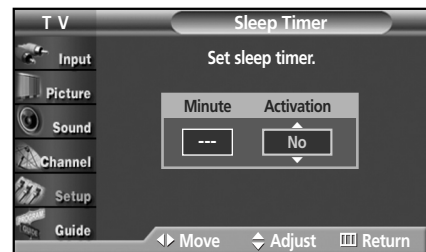

- 5 Press the EXIT button to exit.

P L A S M A D I S P L A Y P A N E L

Function Description

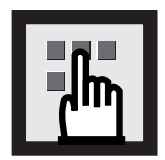

Selecting a Menu Language	104
Digital Noise Reduction	105
Setting the Dynamic Contrast.....	106
Selecting the Film Mode.....	107
Setting the Blue Screen	108
Using the Color Weakness Enhancement Option	109
Viewing Closed Captions (On-Screen Text Messages) - Analog...	110
Viewing Closed Captions (On-Screen Text Messages) - Digital....	111
Menu Transparency Level	113
Using the Energy Saving feature	114
Preventing Screen Burn-in	115
Reducing the Effects of Screen Burn.....	116
Setting the Function Help	117
Using the CableCARD	118
Using the V-Chip (for USA)	120
Using the V-Chip (for Canada).....	126
Electronic Program Guide	134
Remind List	138



Selecting a Menu Language

- 1 Press the MENU button. Press the ▲ or ▼ button to select "Setup", then press the ENTER button.



- 2 Press the ▲ or ▼ button to select "Language", then press the ENTER button.



- 3 Press the ▲ or ▼ button to select the appropriate language: "English", "Spanish", or "French". Press the ENTER button.



- 4 Press the EXIT button to exit.



Digital Noise Reduction

If the broadcast signal received by your TV is weak, you can activate the Digital Noise Reduction feature to help reduce any static and ghosting that may appear on the screen.

- 1 Press the MENU button. Press the ▲ or ▼ button to select "Picture", then press the ENTER button.

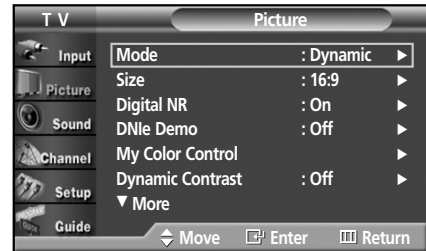

- 2 Press the ▲ or ▼ button to select "Digital NR", then press the ENTER button.

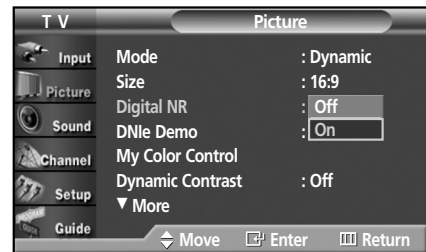

- 3 Press the ▲ or ▼ button to select "On" or "Off", then press the ENTER button.

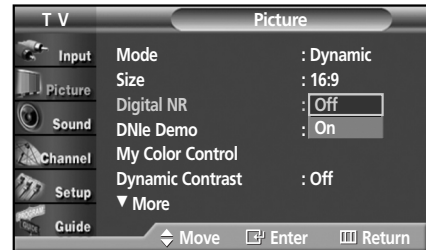

- 4 Press the EXIT button to exit.

Note

- The Digital NR function is available in all modes except PC.

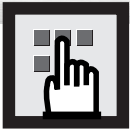

Setting the Dynamic Contrast

Automatically controls the contrast level to avoid excessive level differences.

- 1 Press the MENU button. Press the ▲ or ▼ button to select "Picture", then press the ENTER button.

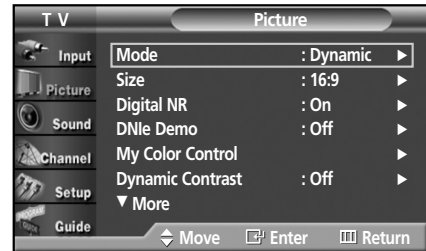

- 2 Press the ▲ or ▼ button to select "Dynamic Contrast", then press the ENTER button.



- 3 Press the ▲ or ▼ button to select "On" or "Off", then press the ENTER button.



- 4 Press the EXIT button to exit.

Note

- Dynamic contrast is not supported in Energy Saving and PC modes.

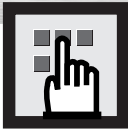

Selecting the Film Mode

On: Automatically senses and processes film signals from all sources and adjusts the picture for optimum quality.

Off: Switches off the Film mode.

- 1 Press the MENU button. Press the ▲ or ▼ button to select "Picture", then press the ENTER button.

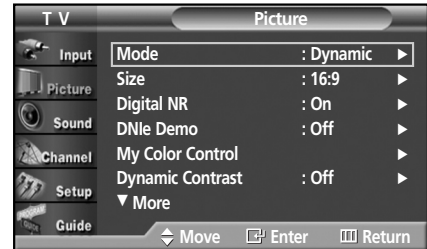

- 2 Press the ▲ or ▼ button to select "Film Mode", then press the ENTER button.



- 3 Press the ▲ or ▼ button to select "On" or "Off", then press the ENTER button.



- 4 Press the EXIT button to exit.

Note

- Film mode is supported in TV, VIDEO, S-VIDEO, and COMPONENT 480i.



Setting the Blue Screen

If no signal is being received or the signal is very weak, a blue screen automatically replaces the noisy picture background. If you wish to continue viewing the poor picture, you must set the "Blue Screen" mode to "Off".

- 1 Press the MENU button. Press the ▲ or ▼ button to select "Picture", then press the ENTER button.

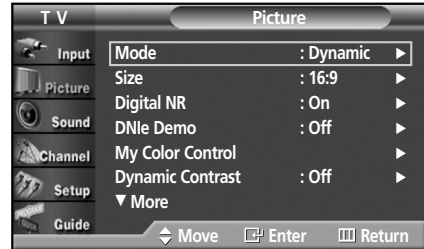

- 2 Press the ▲ or ▼ button to select "Blue Screen", then press the ENTER button.



- 3 Press the ▲ or ▼ button to select "On" or "Off", then press the ENTER button.

- Blue Screen is displayed when there is no signal from an external device in the External Mode, regardless of the Blue Screen Setting.



- 4 Press the EXIT button to exit.



Using the Color Weakness Enhancement Option

This option adjusts the Red, Blue or Green color to enhance the image according to the user's particular color weakness.

- 1 Press the MENU button. Press the ▲ or ▼ button to select "Picture", then press the ENTER button.

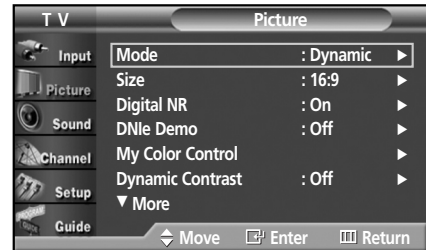

- 2 Press the ▲ or ▼ button to select "Color Weakness", then press the ENTER button.



- 3 Press the ENTER button. Press the ▲ or ▼ button to select "On", then press the ENTER button. You will also see the items "Red", "Green", and "Blue".

- Pressing the ▲ or ▼ button will alternate between "On" and "Off".



- 4 Press the ▲ or ▼ button to select the item you wish to change, then press the ENTER button. Press the ◀ or ▶ button to change the value of the item, then press the ENTER button.

Press the ▲ or ▼ button to select another item.



- 5 Press the EXIT button to exit.



Viewing Closed Captions (On-Screen Text Messages) - Analog

The Analog Caption function operates in either analog RF channel mode or external signal mode.

1 Press the Menu button. Press the ▲ or ▼ button to select "Setup", then press the ENTER button.

➤ Quick way to select Caption: Just press "CAPTION" button under the cover of the remote control.

2 Press the ▲ or ▼ button to select "Caption", then press the ENTER button.

3 Press the ENTER button to select "Caption". Press the ▲ or ▼ button to select "On", then press the ENTER button.

4 Press the ▲ or ▼ button to select "Caption Mode", then press the ENTER button. Press the ▲ or ▼ button to select submenu (CC1~CC4 or Text1~Text4) you want, then press the ENTER button.

- The default is "CC1".
 - CC1 : The Primary Synchronous Caption Service. These are captions in the primary language that must be in sync with the sound, preferably matched to a specific frame.
 - CC2 : The Special Non-Synchronous Use Captions. This channel carries data that is intended to augment information carried in the program.
 - CC3 : Secondary Synchronous Caption Service. Alternate program-related caption data, typically second language captions.
 - CC4 : Special Non-Synchronous Use Captions. Similar to CC2.
 - Text1 : First Text Service. This may be various non-program related data.
 - Text2 : Second Text Service. Additional data, usually not program related.
 - Text3/Text4 : Third and Fourth Text Services. These data channels are used only if Text1 and Text2 data bandwidths not sufficient.

5 Press the EXIT button to exit.

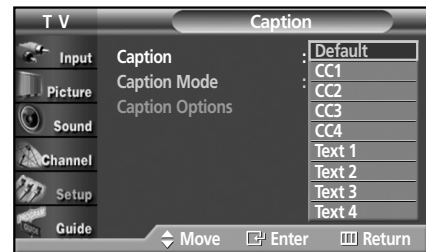
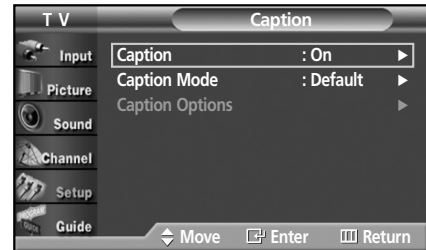
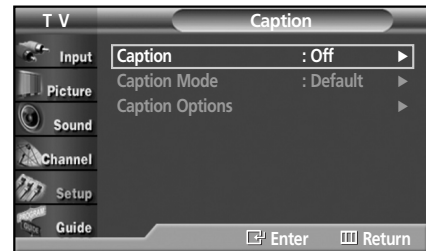

Notes

- The Caption feature doesn't work in COMPONENT, PC, HDMI(DVI) modes.
- The availability of captions depends on the program being broadcast.



Viewing Closed Captions (On-Screen Text Messages) - Digital

The Digital Captions function operates on digital channels.

- 1 Press the MENU button.
Press the ▲ or ▼ button to select "Setup", then press the ENTER button.



- 2 Press the ▲ or ▼ button to select "Caption", then press the ENTER button.

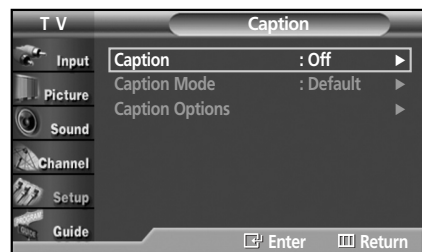

- 3 Press the ENTER button to select "Caption".
Press the ▲ or ▼ button to select "On", then press the ENTER button.

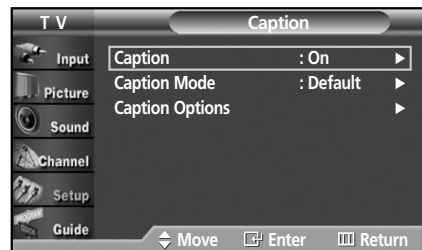

- 4 Press the ▲ or ▼ button to select "Caption Mode", then press the ENTER button.
Press the ▲ or ▼ button to select submenu (Service1~Service6, CC1~CC4 or Text1~Text4) you want, then press the ENTER button.

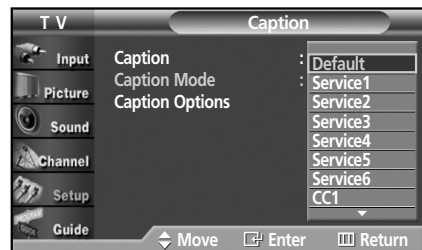

- 5 Press the ▲ or ▼ button to select "Caption Options", then press the ENTER button.



Notes

- "Caption Options" are available only when "Service1~Service6" can be selected in "Caption Mode".
- Service1~6 in digital caption mode may not be available according to the broadcasting type.

6 Press the ▲ or ▼ button to select "Size", then press the ENTER button.

Press the ▲ or ▼ button to select the desired Caption option, then press the ENTER button.

Press the ▲ or ▼ button to select the desired sub-menu options(see options below), then press ENTER.

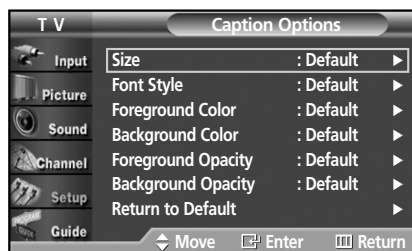

Notes

- The availability of captions depends on the program being broadcast.
- "Default" means to return to the original caption options set by the broadcaster.

7 Press the EXIT button to exit.

- **Size**

This option consists of "Default", "Small", "Standard", and "Large". The default is "Standard".

- **Font Style**

This option consists of "Default", "Style 0 ~ Style 7". You can change the font you want. The default is "Style 0".

- **Foreground Color**

This option consists of "Default", "White", "Black", "Red", "Green", "Blue", "Yellow", "Magenta", and "Cyan". You can change the color of the letter. The default is "White".

- **Background Color**

This option consists of "Default", "White", "Black", "Red", "Green", "Blue", "Yellow", "Magenta", and "Cyan". You can change the background color of the caption. The default is "Black".

- **Foreground Opacity**

This option consists of "Default", "Transparent", "Translucent", "Solid", and "Flashing". You can change the opacity of the letter.

- **Background Opacity**

This option consists of "Default", "Transparent", "Translucent", "Solid", and "Flashing". You can change the background opacity of the caption.

- **Return to Default**

This option sets each of "Size", "Font Style", "Foreground Color", "Background color", "Foreground Opacity", and "Background Opacity" to its default.

Alternate method:

Press the CAPTION button on the remote control repeatedly to select "On" or "Off".

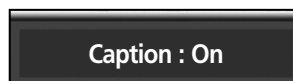



Menu Transparency Level

Adjusts the transparency of the menu screen.

- 1 Press the MENU button.
Press the ▲ or ▼ button to select "Setup", then press the ENTER button.



- 2 Press the ▲ or ▼ button to select "Menu Transparency", then press the ENTER button.
Press the ▲ or ▼ button to select level, then press the ENTER button.



- 3 Press the EXIT button to exit.

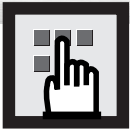

Using the Energy Saving Feature

This feature adjusts the screen brightness automatically depending on the surrounding lighting conditions.

1 Press the MENU button. Press the ▲ or ▼ button to select "Setup", then press the ENTER button.

➤ Quick way to select Energy Saving: Just press "E.SAVING" button under the cover of the remote control.



2 Press the ▲ or ▼ button to select "Energy Saving", then press the ENTER button.

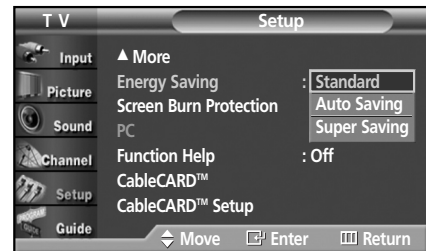

3 Press the ▲ or ▼ button to select submenu (Standard, Auto Saving or Super Saving) you want, then press the ENTER button.

- Standard : Operates in standard mode regardless of the surrounding illumination.
- Auto Saving : Automatically adjusts to the surrounding illumination.
- Super Saving : Enters maximum power saving mode regardless of the surrounding illumination.

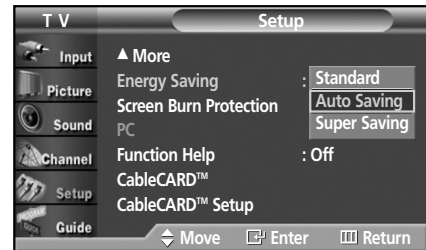

4 Press the EXIT button to exit.

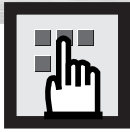

Preventing Screen Burn-in

To reduce the possibility of screen burn, this unit is equipped with screen burn prevention technology. This technology enables you to set picture movement up/down (Vertical Line) and side to side (Horizontal Dot). The Time setting allows you to program the time between movement of the picture in minutes.

- 1 Press the MENU button.
Press the ▲ or ▼ button to select "Setup", then press the ENTER button.



- 2 Press the ▲ or ▼ button to select "Screen Burn Protection", then press the ENTER button.

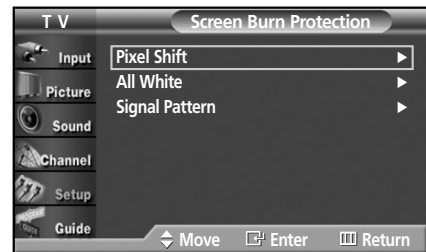

- 3 Press the ENTER button to select "Pixel Shift", then press the ENTER button.

- Pressing the ▲ or ▼ button will alternate between "On" and "Off".
You will also see the items "Horizontal Dot", "Vertical Line" and "Time".
- Pixel Shift: Using this function, you can minutely move pixels on the PDP in horizontal or vertical direction to prevent after-images on the screen.

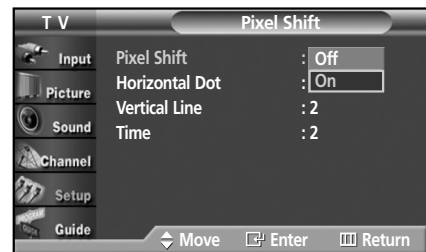

- 4 Press the ▲ or ▼ button to select the item you wish to change, then press the ENTER button.
Press the ▲ or ▼ button to change the value of the item, then press the ENTER button.

- Optimum condition for pixel shift;

Horizontal Dot	2
Vertical Line	2
Time(min)	2

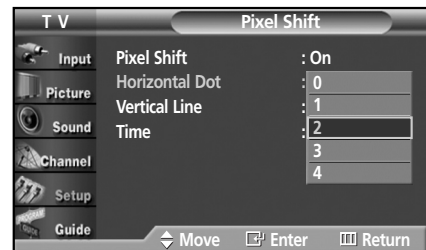

- 5 Press the EXIT button to exit.

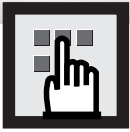

Reducing the Effects of Screen Burn

If screen burn has occurred, you can select a white screen or signal pattern (rolling screen) to help remove screen burn artifacts.

- 1 Press the MENU button.
Press the ▲ or ▼ button to select "Setup", then press the ENTER button.



- 2 Press the ▲ or ▼ button to select "Screen Burn Protection", then press the ENTER button.

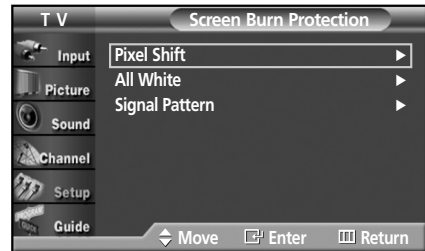

- 3 Press the ▲ or ▼ button to select "All White" or "Signal Pattern", then press the ENTER button.

- All White: This function removes after-images on the screen by changing the color of pixels to white. Use this function when there are remaining after-images or symbols on the screen especially when you displayed a still image on the screen for a long time.
- Signal Pattern: This function removes after-images on the screen by running a special pattern. Use this function when there are remaining after-images or symbols on the screen especially when you displayed a still image on the screen for a long time.

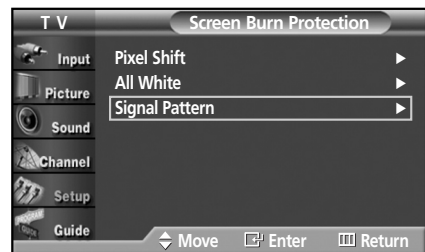
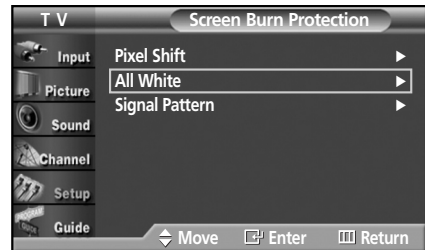

- 4 Press the EXIT button to exit.

Notes

- To remove after-images on the screen, use either the "All White" or "Signal Pattern" function. Although both functions remove after-images on the screen, "Signal Pattern" is more effective.
- The after-image removal function has to be executed for a long time (approximately 1 hour) to effectively remove after-images on the screen. If the after-image is not removed after performing the function, repeat the function again.
- Press any key on the remote control to cancel this feature.

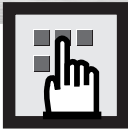

Setting the Function Help

Displays help on the menu functions.

- 1 Press the MENU button.
Press the ▲ or ▼ button to select "Setup", then press the ENTER button.



- 2 Press the ▲ or ▼ button to select "Function Help", then press the ENTER button.

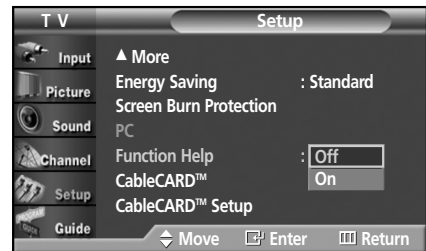

- 3 Press the ▼ button to select "On", then press the ENTER button.



- 4 Press the EXIT button to exit.

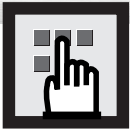

Using the CableCARD

This menu works with a CableCARD provided by a local cable service provider.

Prior to accessing this menu, a CableCARD should be connected to the rear panel of the TV.

For detailed connection instructions, refer to the "Connecting CableCARD" section on page 31 of this manual.

Displaying CableCARD related information

To access information on Status, Pairing, Network Setup of the CableCARD provided by the service provider in CableCARD menu.

1 Press the MENU button. Press the ▲ or ▼ button to select "Setup", then press the ENTER button.

- Make sure the CableCARD is inserted.



2 Press the ▲ or ▼ button to select "CableCARD™", then press the ENTER button.



3 Press the EXIT button to exit.

Using the CableCARD Setup Function

Sets up relevant CableCARD options.

- 1 Press the MENU button. Press the ▲ or ▼ button to select "Setup", then press the ENTER button.



- 2 Press the ▲ or ▼ button to select "CableCARD™ Setup", then press the ENTER button.



- 3 Press the ENTER button to select "CableCARD™ Reset".
 - Resets CableCARD when the channels provided by CableCARD are not available.



- 4 Press the ▲ or ▼ button to select "Channel List Reorganization".
 - Deletes and reorganizes the channel list provided by CableCARD. This feature should be used if you change or upgrade your CableCARD service.





Using the V-Chip (for USA)

The V-Chip feature automatically locks out programs that are deemed inappropriate for children. The user must enter a PIN (personal ID number) before any of the V-Chip restrictions are set up or changed.

- Notes :
- When the V-chip feature is activated, the PIP features do not function.
 - The V-Chip does not work if the input is DTV (HD or SD).
 - V-Chip function is not available in HDMI or component mode.

Setting Up Your Personal ID Number (PIN)

- 1 Press the MENU button. Press the ▲ or ▼ button to select "Setup", then press the ENTER button.



- 2 Press the ▲ or ▼ button to select "V-Chip", then press the ENTER button. The message "Enter PIN" will appear. Enter your 4 digit PIN.

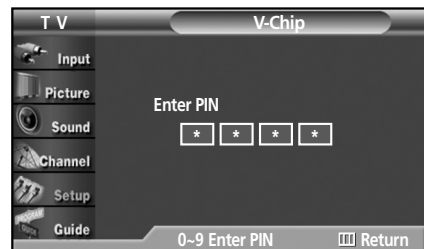

- The default PIN of a new TV set is "0-0-0-0".

- 3 The V-Chip screen will appear. Press the ▲ or ▼ button to select "Change PIN", then press the ENTER button.

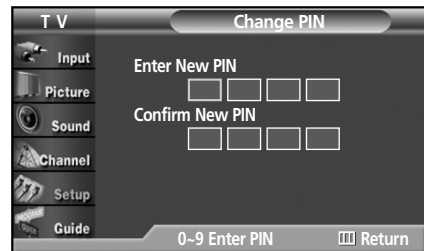

- 4 The Change PIN screen will appear. Choose any 4 digits for your PIN and enter them. As soon as the 4 digits are entered, "Confirm new PIN" screen appears. Re-enter the same 4 digits. When the Confirm screen disappears, your PIN has been memorized.

- 5 Press the EXIT button to exit.

Note

- If you forget the PIN, press the remote-control buttons in the following sequence, which resets the pin to 0-0-0-0 : Power Off. → Mute → 8 → 2 → 4 → Power On.

How to Enable/Disable the V-Chip

- 1 Press the MENU button. Press the ▲ or ▼ button to select "Setup", then press the ENTER button.



- 2 Press the ▲ or ▼ button to select "V-Chip", then press the ENTER button.
The message "Enter PIN" will appear.
Enter your 4 digit PIN.

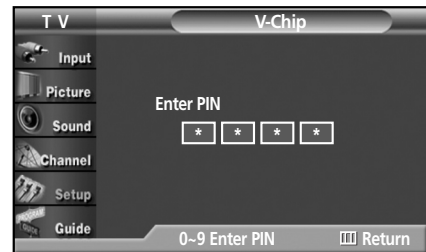

- 3 The V-Chip screen will appear. To enable the V-Chip feature, press the ENTER button so that "V-Chip Lock" field is "On". (Pressing the ▲ or ▼ button will alternate between "On" and "Off".)
Press the ENTER button.

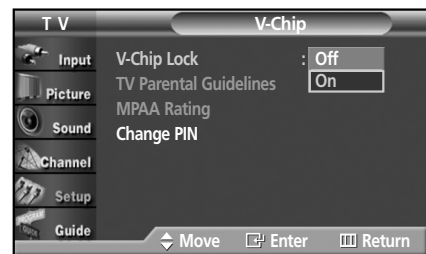

- 4 Press the EXIT button to exit.

How to Set up Restrictions using "TV Parental Guidelines"

First, set up a personal identification number (PIN), and enable the V-Chip. (See previous section.) Parental restrictions can be set up using either of two methods: The TV guidelines or the MPA rating.

- 1 Press the MENU button. Press the ▲ or ▼ button to select "Setup", then press the ENTER button.



- 2 Press the ▲ or ▼ button to select "V-Chip", then press the ENTER button. The message "Enter PIN" will appear. Enter your 4 digit PIN.

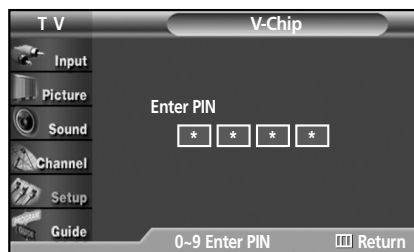

- 3 The V-Chip screen will appear. Press the ▲ or ▼ button to select "TV Parental Guidelines", then press the ENTER button.

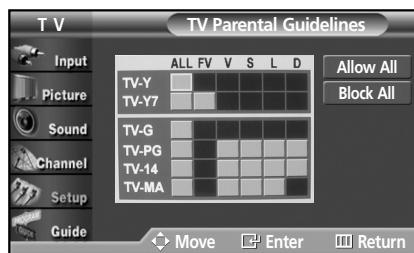

- 4 The TV Parental Guidelines screen will appear. Press the ▲ or ▼ button to select one of the six ages based categories:



TV-Y	Young children
TV-Y7	Children 7 and over

TV-G	General audience
TV-PG	Parental guidance
TV-14	Viewers 14 and over
TV-MA	Mature audience

Note

- Allow All : Press to unlock all TV ratings.
- Block All : Press to lock all TV ratings.

Plasma Display

-
- 5** At this point, one of the TV-Ratings is selected. Press the ENTER button. Depending on your existing setup, a symbol  will be selected. (Blank = Unblocked,  = Blocked)

While "" is selected, press the ENTER button to block or unblock the category. To select a different TV-Rating, press the ▲ or ▼ button and then repeat the process.

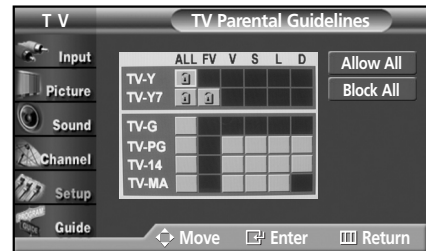



Note 1: The TV-Y, TV-Y7, TV-G, TV-PG, TV-14 and TV-MA have additional options. See the next step to change any of the following sub-ratings:

FV: Fantasy violence
D: Sexually Suggestive Dialog
L: Adult Language
S: Sexual situation
V: Violence

Note 2: The V-Chip will automatically block certain categories that are "more restrictive". For example, if you block "TV-Y" category, then TV-Y7 will automatically be blocked. Similarly, if you block the TV-G category, then all the categories in the "young adult" group will be blocked (TV-Y, TV-Y7, TV-G, TV-PG, TV-14, and TV-MA). The sub-ratings (D, L, S, V) work together similarly. (See next section.)

-
- 6** How to set the FV, D, L, S and V sub-ratings. First, select one of these TV-Ratings: TV-Y, TV-Y7, TV-G, TV-PG, TV-14, or TV-MA (See Step 4, on previous page), and press the ► button.

A symbol "" will be displayed for each sub-rating. While "" is selected, press the ENTER button to go to a sub rating. Press ENTER to block the sub rating. To select a different TV-Rating, press the ▲ or ▼ button and then repeat the process.

Note: The V-chip will automatically block certain categories that are "More restrictive". For example, if you block "L" sub-rating in TV-PG, then the "L" sub-ratings in TV-14 and TV-MA will automatically be blocked.

-
- 7** Press the MENU button to clear all the screens. (Or proceed to the next section, and set up additional restrictions based on the MPAA codes.)

Notes

- These categories consist of two separate groups: TV-Y and TV-Y7 (young children through age 7), and TV-G through TV-MA (everybody else). The restrictions for these two groups work independently: If a household includes very young children as well as young adults, the TV guidelines must be set up separately for each age group. (See next step.)
- Allow All : Press to unlock all TV ratings.
- Block All : Press to lock all TV ratings.

How to Set up Restrictions using the MPAA Ratings: G, PG, PG-13, R, NC-17, X, NR

The MPAA rating system uses the Motion Picture Association of America (MPAA) system, and its main application is for movies. When the V-Chip lock is on, the TV will automatically block any programs that are coded with objectionable ratings (either MPAA or TV-Ratings).

- 1 Press the MENU button. Press the ▲ or ▼ button to select "Setup", then press the ENTER button.



- 2 Press the ▲ or ▼ button to select "V-Chip", then press the ENTER button. The message "Enter PIN" will appear. Enter your 4 digit PIN.

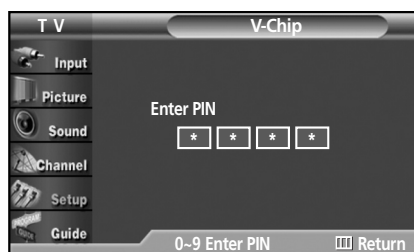

- 3 The V-Chip screen will appear. Press the ▲ or ▼ button to select "MPAA Rating", then press the ENTER button.

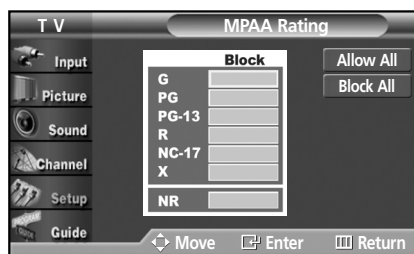

- 4 The MPAA Rating screen will appear. Repeatedly press the ▲ or ▼ button to select a particular MPAA category. Pressing the ▲ or ▼ button will cycle through the MPAA categories:

G	General audience (no restrictions).
PG	Parental guidance suggested.
PG-13	PG-13 (Parents strongly cautioned).
R	R (Restricted. Children under 17 should be accompanied by an adult).
NC-17	No children under age 17.
X	X (Adults only).
NR	Not rated.

While a particular category is selected, press the ENTER button to activate it.

A selected symbol "🔒" will be displayed.

Press the ENTER button to block or unblock the category.

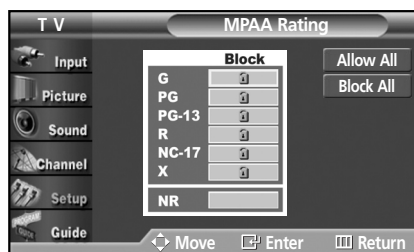

Notes

- The V-Chip will automatically block any category that is "more restrictive". For example, if you block "PG-13" category, then "R", "NC-17" and "X" will automatically be blocked also.
- Allow All : Press to unlock all TV ratings.
- Block All : Press to lock all TV ratings.

How to Reset the TV after the V-Chip Blocks a Channel ("Emergency Escape")

If the TV is tuned to a restricted channel, the V-Chip will block it. The screen will go blank and the following message will appear:

1 Enter your PIN.

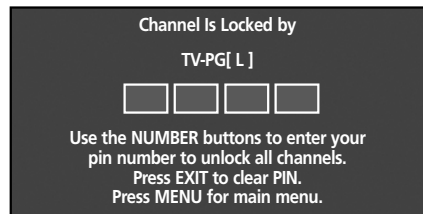
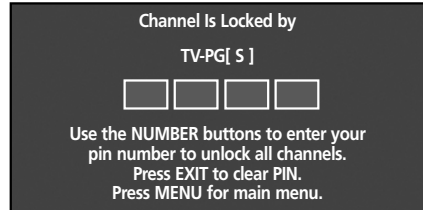

To resume normal viewing, tune to a different channel using CH \wedge or CH \vee button. Under certain conditions (depending on the rating of the local TV programs) the V-Chip might lock out all the channels. In this case, use the V-Chip function for an "emergency escape":

1 Press the MENU button. Press the \blacktriangle or \blacktriangledown button to select "Setup", then press the ENTER button.

2 Press the \blacktriangle or \blacktriangledown button to select "V-Chip", then press the ENTER button.

3 Enter your PIN then press the ENTER, and press the \blacktriangle or \blacktriangledown button to temporarily disable the V-Chip Lock.

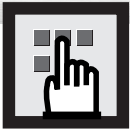

Using the V-Chip (for Canada)

The V-Chip feature automatically locks out programs that are deemed inappropriate for children. The user must enter a PIN (personal ID number) before any of the V-Chip restrictions are set up or changed.

- Notes :
- When the V-chip feature is activated, the PIP features do not function.
 - The V-Chip does not work if the input is DTV (HD or SD).
 - V-Chip function is not available in HDMI or component mode.

Setting Up Your Personal ID Number (PIN)

- 1 Press the MENU button. Press the ▲ or ▼ button to select "Setup", then press the ENTER button.



- 2 Press the ▲ or ▼ button to select "V-Chip", then press the ENTER button. The message "Enter PIN" will appear. Enter your 4 digit PIN.

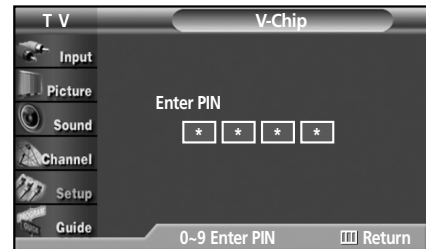

Note

- The default PIN of a new TV set is "0-0-0-0".

- 3 The V-Chip screen will appear. Press the ▲ or ▼ button to select "Change PIN", then press the ENTER button.

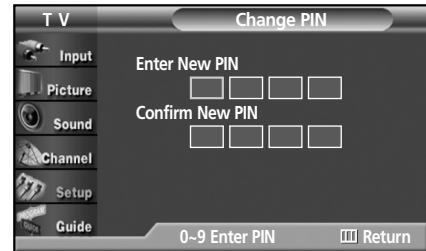

- 4 The Change PIN screen will appear. Choose any 4 digits for your PIN and enter them. As soon as the 4 digits are entered, "Confirm new PIN" screen appears. Re-enter the same 4 digits. When the Confirm screen disappears, your PIN has been memorized.

- 5 Press the EXIT button to exit.

Note

- If you forget the PIN, press the remote-control buttons in the following sequence, which resets the pin to 0-0-0-0 : Power Off. → Mute → 8 → 2 → 4 → Power On.

How to Enable/Disable the V-Chip

- 1 Press the MENU button. Press the ▲ or ▼ button to select "Setup", then press the ENTER button.



- 2 Press the ▲ or ▼ button to select "V-Chip", then press the ENTER button.
The message "Enter PIN" will appear.
Enter your 4 digit PIN.

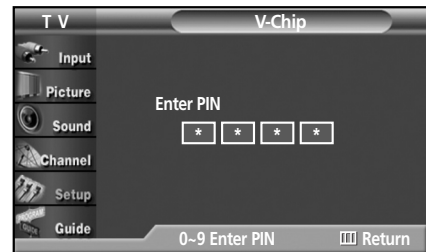

- 3 The V-Chip screen will appear. To enable the V-Chip feature, press the ENTER button so that "V-Chip Lock" field is "On". (Pressing the ▲ or ▼ button will alternate between "On" and "Off".)
Press the ENTER button.



- 4 Press the EXIT button to exit.

How to Set up Restrictions using "TV Parental Guidelines"

First, set up a personal identification number (PIN), and enable the V-Chip. (See previous section.) Parental restrictions can be set up using either of two methods: The TV guidelines or the MPA rating.

- 1 Press the MENU button. Press the ▲ or ▼ button to select "Setup", then press the ENTER button.



- 2 Press the ▲ or ▼ button to select "V-Chip", then press the ENTER button. The message "Enter PIN" will appear. Enter your 4 digit PIN.

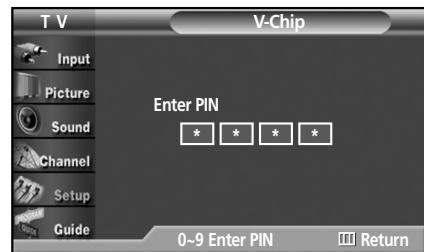

- 3 The V-Chip screen will appear. Press the ▲ or ▼ button to select "TV Parental Guidelines", then press the ENTER button.

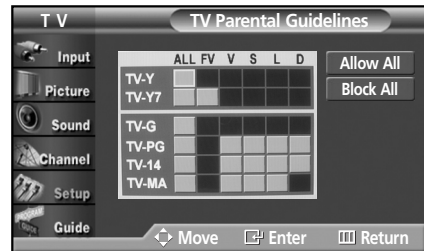



- 4 The TV Parental Guidelines screen will appear. Press the ▲ or ▼ button to select one of the six age based categories:

TV-Y	Young children
TV-Y7	Children 7 and over

TV-G	General audience
TV-PG	Parental guidance
TV-14	Viewers 14 and over
TV-MA	Mature audience

Note

- Allow All : Press to unlock all TV ratings.
- Block All : Press to lock all TV ratings.

- 5** At this point, one of the TV-Ratings is selected. Press the ENTER button. Depending on your existing setup, a symbol  will be selected. (Blank = Unblocked,  = Blocked)

While "" is selected, press the ENTER button to block or unblock the category. To select a different TV-Rating, press the ▲ or ▼ button and then repeat the process.

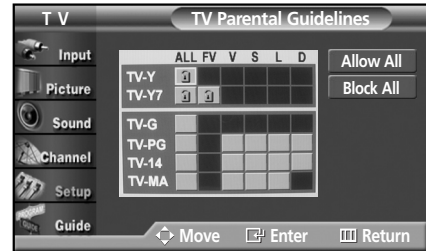



Note 1: The TV-Y, TV-Y7, TV-G, TV-PG, TV-14 and TV-MA have additional options. See the next step to change any of the following sub-ratings:

- FV: Fantasy violence
- D: Sexually Suggestive Dialog
- L: Adult Language
- S: Sexual situation
- V: Violence

Note 2: The V-Chip will automatically block certain categories that are "more restrictive". For example, if you block "TV-Y" category, then TV-Y7 will automatically be blocked. Similarly, if you block the TV-G category, then all the categories in the "young adult" group will be blocked (TV-Y, TV-Y7, TV-G, TV-PG, TV-14, and TV-MA). The sub-ratings (D, L, S, V) work together similarly. (See next section.)

- 6** How to set the FV, D, L, S and V sub-ratings. First, select one of these TV-Ratings: TV-Y, TV-Y7, TV-G, TV-PG, TV-14, or TV-MA (See Step 4, on previous page), and press the ► button.

A symbol "" will be displayed for each sub-rating. While "" is selected, press the ENTER button to go to a sub rating. Press ENTER to block the sub rating. To select a different TV-Rating, press the ▲ or ▼ button and then repeat the process.

Note: The V-chip will automatically block certain categories that are "More restrictive". For example, if you block "L" sub-rating in TV-PG, then the "L" sub-ratings in TV-14 and TV-MA will automatically be blocked.

- 7** Press the MENU button to clear all the screens. (Or proceed to the next section, and set up additional restrictions based on the MPAA codes.)

Notes

- These categories consist of two separate groups: TV-Y and TV-Y7 (young children through age 7), and TV-G through TV-MA (everybody else). The restrictions for these two groups work independently: If a household includes very young children as well as young adults, the TV guidelines must be set up separately for each age group. (See next step.)
- Allow All : Press to unlock all TV ratings.
- Block All : Press to lock all TV ratings.

How to Set up Restrictions using the MPAA Ratings: G, PG, PG-13, R, NC-17, X, NR

The MPAA rating system uses the Motion Picture Association of America (MPAA) system, and its main application is for movies. When the V-Chip lock is on, the TV will automatically block any programs that are coded with objectionable ratings (either MPAA or TV-Ratings).

1 Press the MENU button. Press the ▲ or ▼ button to select "Setup", then press the ENTER button.



2 Press the ▲ or ▼ button to select "V-Chip", then press the ENTER button. The message "Enter PIN" will appear. Enter your 4 digit PIN.

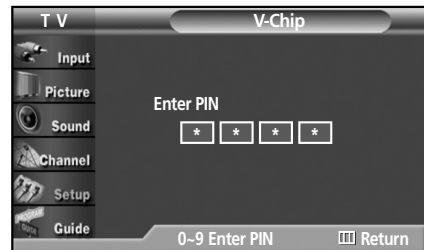

3 The V-Chip screen will appear. Press the ▲ or ▼ button to select "MPAA Rating", then press the ENTER button.

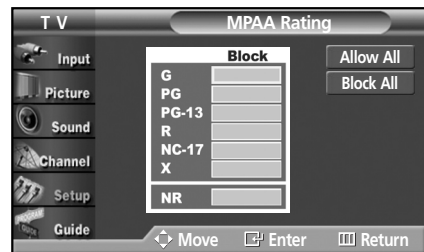

4 The MPAA Rating screen will appear. Repeatedly press the ▲ or ▼ button to select a particular MPAA category. Pressing the ▲ or ▼ button will cycle through the MPAA categories:

- G** General audience (no restrictions).
- PG** Parental guidance suggested.
- PG-13** PG-13 (Parents strongly cautioned).
- R** R (Restricted. Children under 17 should be accompanied by an adult).
- NC-17** No children under age 17.
- X** X (Adults only).
- NR** Not rated.

While a particular category is selected, press the ENTER button to activate it. A selected symbol "Ⓜ" will be displayed. Press the ENTER button to block or unblock the category.

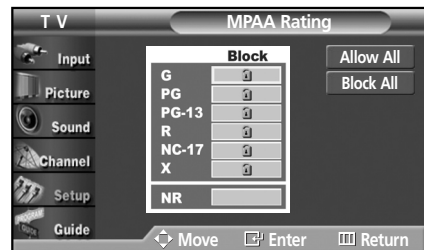

Notes

- The V-Chip will automatically block any category that is "more restrictive". For example, if you block "PG-13" category, then "R", "NC-17" and "X" will automatically be blocked also.
- Allow All : Press to unlock all TV ratings.
- Block All : Press to lock all TV ratings.

How to Set up Restrictions using "Canadian English": E, C, C8+, G, PG, 14+, 18+

First, set up a personal identification number (PIN), and enable the V-Chip. (refer to page 127)

1 Press the MENU button. Press the ▲ or ▼ button to select "Setup", then press the ENTER button.



2 Press the ▲ or ▼ button to select "V-Chip", then press the ENTER button. The message "Enter PIN" will appear. Enter your 4 digit PIN.

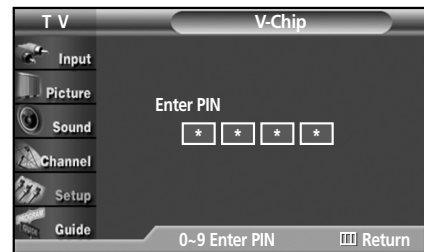

3 The V-Chip screen will appear. Press the ▲ or ▼ button to select "Canadian English", then press the ENTER button.



4 The Canadian English screen will appear. Repeatedly press the ▲ or ▼ button to select a particular Canadian English category. Pressing the ▲ or ▼ button will cycle through the Canadian English categories:

E	Exempt programming includes...news, sports, documentaries and other information programming, talk shows, music videos, and variety programming.
C	Programming intended for children under age 8
C8+	Programming generally considered acceptable for children 8 years and over to watch on their own
G	General programming, suitable for all audiences
PG	Parental Guidance
14+	Programming contains themes or content which may not be suitable for viewers under the age of 14
18+	Adult Programming

While a particular category is selected, press the ENTER button to activate it.

A selected symbol "🔒" will be displayed.

Press the ▲ or ▼ button to select other items.

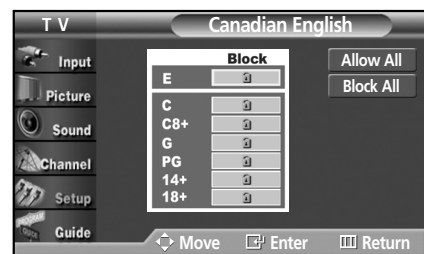

5 Press the MENU button to save the settings and to clear all screens.

Notes

- The V-Chip will automatically block any category that is "more restrictive". For example, if you block "G" category, then "PG", "14+" and "18+" will automatically be blocked also.
- Allow All : Press to unlock all TV ratings.
- Block All : Press to lock all TV ratings.

How to Set up Restrictions using "Canadian French": E, G, 8 ans +, 13 ans +, 16 ans +, 18 ans +

First, set up a personal identification number (PIN), and enable the V-Chip. (refer to page 127)

1 Press the MENU button. Press the ▲ or ▼ button to select "Setup", then press the ENTER button.

2 Press the ▲ or ▼ button to select "V-Chip", then press the ENTER button.
The message "Enter PIN" will appear.
Enter your 4 digit PIN.

3 The V-Chip screen will appear. Press the ▲ or ▼ button to select "Canadian French", then press the ENTER button.

4 The Canadian French screen will appear.
Repeatedly press the ▲ or ▼ button to select a particular Canadian French category.
Pressing the ▲ or ▼ button will cycle through the Canadian French categories:

E Exempt programming includes...news, sports, documentaries and other information programming, talk shows, music videos, and variety programming.

G General

8 ans + 8+ General – Not recommended for young children

13 ans + Programming may not be suitable for children under the age of 13

16 ans + Programming is not suitable for children under the age of 16

18 ans + Programming restricted to adults

While a particular category is selected, press the ENTER button to activate it.

A selected symbol "🔒" will be displayed.

Press the ▲ or ▼ button to select other items.

5 Press the MENU button to save the settings and to clear all screens.

Notes

- The V-Chip will automatically block any category that is "more restrictive". For example, if you block "8 ans+" category, then "13 ans+", "16 ans+" and "18 ans+" will automatically be blocked also.
- Allow All : Press to unlock all TV ratings.
- Block All : Press to lock all TV ratings.

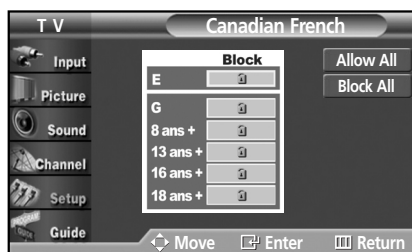
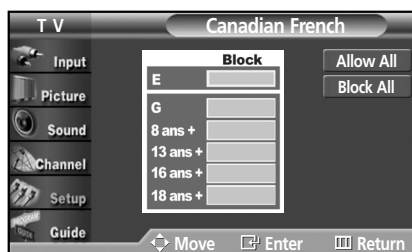
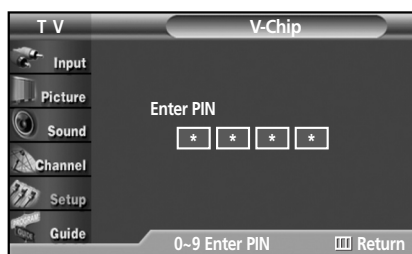
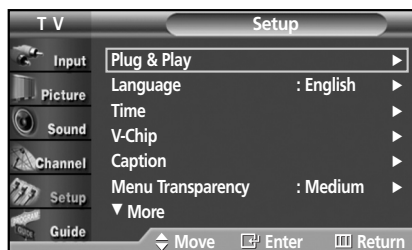

How to Reset the TV after the V-Chip Blocks a Channel (“Emergency Escape”)

If the TV is tuned to a restricted channel, the V-Chip will block it. The screen will go blank and the following message will appear:

1 Enter your PIN.

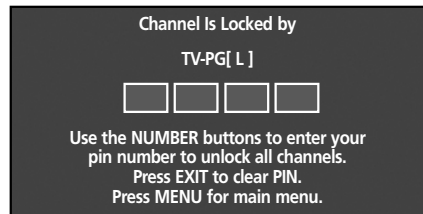
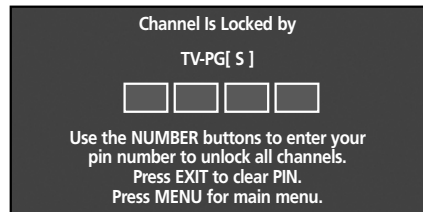

To resume normal viewing, tune to a different channel using CH \wedge or CH \vee button. Under certain conditions (depending on the rating of the local TV programs) the V-Chip might lock out all the channels. In this case, use the V-Chip function for an “emergency escape”:

1 Press the MENU button. Press the \blacktriangle or \blacktriangledown button to select “Setup”, then press the ENTER button.

2 Press the \blacktriangle or \blacktriangledown button to select “V-Chip”, then press the ENTER button.

3 Enter your PIN then press the ENTER, and press the \blacktriangle or \blacktriangledown button to temporarily disable the V-Chip Lock.

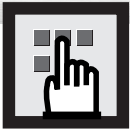

Electronic Program Guide

Your TV has an “Electronic Program Guide” to help you navigate through all the possible viewing options. The EPG supplies information, such as program lists, start and end times of all available channels. In addition, detailed information about the program is often available in the EPG. (The availability and the amount of program details will vary depending on the broadcaster.)

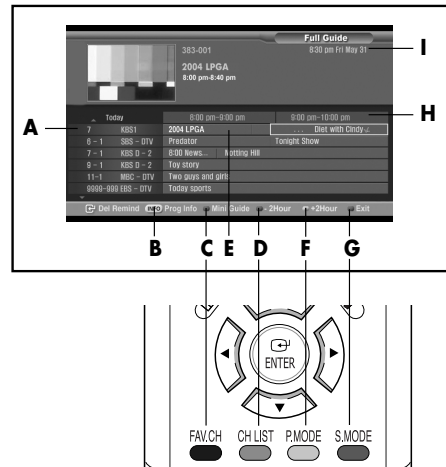

Viewing the Electronic Program Guide

- A** Displays which channel is currently selected to show program information in the Channel Guide.
- B** Press to view detailed information for the selected digital program.
- C** Switches to the mini program guide. The mini guide shows the titles of the available programs of one channel. Press the Red button on the remote control. The set default guide is Mini Guide.
- D** Scrolls backwards quickly (2 hours). Press the Green button on the remote control.
- E** Displays titles and other details about upcoming programs of particular channels. Highlight the program and press the INFO button to see additional and detailed information. (The availability of additional details depends on the broadcaster.) Use the ▲/▼/◀/▶ buttons to search information about another channel.
- F** Scrolls forward quickly (2 hours). Press the Yellow button on the remote control and repeatedly press the ENTER button the appropriate time is displayed.
- G** Exits from the Program Guide and returns to normal viewing mode. Press the Blue button on the remote control.
- H** Displays the program times (arranged in 1 hour time blocks).
- I** Displays the current time and date.

Note

- You can use the GUIDE button on the remote control to display the Electronic Program Guide. The EPG begins its list with the channel that is currently active. The EPG will only work when you are receiving digital channels.

Using the Electronic Program Guide

- 1 Press the MENU button.
Press the ▲ or ▼ button to select "Guide", then press the ENTER button.



- 2 Press the ▲ or ▼ button to select "Default Guide", then press the ENTER button.

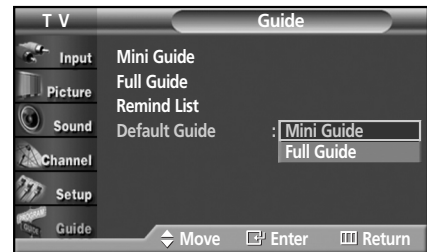

- 3 Press the ▲ or ▼ button to select "Mini Guide" or "Full Guide", then press the ENTER button.
 - Mini Guide : Displays the guide for one channel.
 - Full Guide : Displays the guide for all channels.



- 4 Press the EXIT button to exit.

Viewing Information about a Single Channel

- 1 Press the MENU button.
Press the ▲ or ▼ button to select "Guide", then press the ENTER button.



- 2 Press the ENTER button to select "Mini Guide".
Press the ▲ or ▼ buttons to view information about one channel by time.

You can switch between Full Guide mode and Mini Guide mode by pressing the Red button repeatedly.

Select the program you want by pressing the ▲ or ▼ buttons and press the INFO button on the remote control.

- ENTER button: Press to watch the current program or to add the program to remind list.
- Red button : Press to switch to the program guide for all channels.
Press again to switch to the program information for the selected channel.
- Blue button : Press to exit.
- INFO button : Press to view detailed information for the selected digital program.

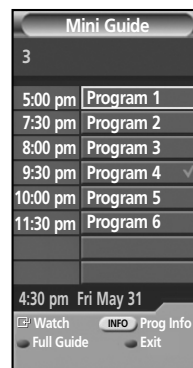

- 3 Press the Blue button or EXIT button to exit.

Notes

- You can also view information about a single channel by pressing the GUIDE button on the remote control. (The EPG should be pre-set in Mini Guide mode.)
- Press the INFO button on the remote control to view the program information for the current channel.

Viewing Information about Channels

Displays the program time and content for all channels.
This function is available only when the program is digital.

- 1 Press the MENU button.
Press the ▲ or ▼ button to select "Guide", then press the ENTER button.
- 2 Press the ▲ or ▼ button to select "Full Guide", then press the ENTER button.



- 3 Press the Green button to activate "-2 Hours" and the Yellow button to activate "+2 Hours".
 - INFO button : Displays detailed information for the selected digital program.
 - ▲/▼ button : Displays program information for each channel, based on the time. Select your desired program using the ▲/▼ button, and then press the INFO button to view the program information for the selected program.
 - Red button : Each press switches between program information for one channel and all channels.
 - Green button : Press to view the program information from two hours ago.
 - Yellow button : Press to view the program information for two hours from now.
 - Blue button : Press to exit.
 - ENTER button : Press to watch the current program or to add the program to remind list.

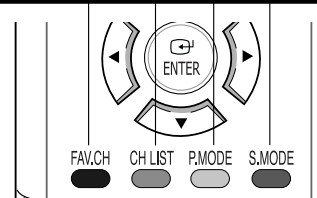
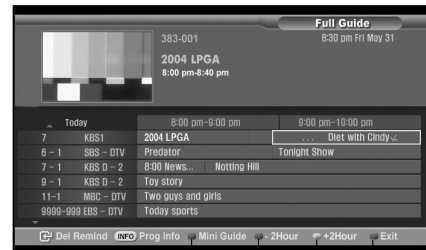

- 4 You may now:
 - Jump to a channel directly : Use the ▲, ▼, ◀, or ▶ button to highlight the program and press the ENTER button.
 - Obtain additional program details : Highlight the title of a program using the ▲, ▼, ◀, or ▶ buttons and press the INFO button.
 - Exit from the Program Guide and return to normal viewing mode : Press the Blue button or the EXIT button.

Notes

- The current time displayed on the program information is subject to the time information sent from the broadcasting station, so it may differ from the actual time.
- Press the GUIDE button on the remote control to view the program information for all channels. However, this function is available only when the default program guide setting is set to "Full Guide".

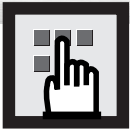

Viewing the Remind List

If you have made a scheduled viewing list of programs you would like to see, the channel will be automatically switched to the scheduled program at the scheduled time even if you are watching another program.

- 1 Press the MENU button.
Press the ▲ or ▼ button to select "Guide", then press the ENTER button.



- 2 Press the ENTER button to select "Full Guide".
Press the ▲ or ▼ button to select programs you would like to see, then press the enter button.
The symbol "✓" will be displayed.
Each press of the enter button will switch between "Remind" and "Del Remind" (Del=Delete).

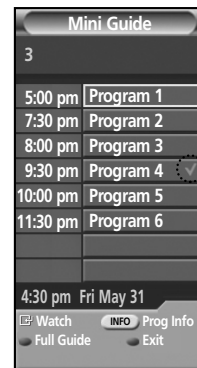

Remind List

- 3 Press the EXIT button to exit.

Note

- Up to 8 programs can be reminded.

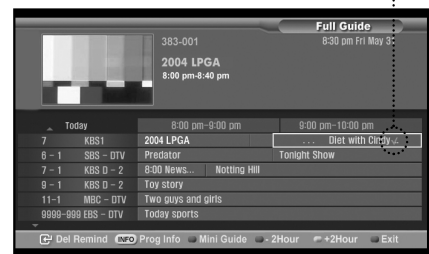

To view the Remind List

- 1 Press the MENU button.
Press the ▲ or ▼ button to select "Guide", then press the ENTER button.



- 2 Press the ▲ or ▼ button to select "Remind List", then press the ENTER button.

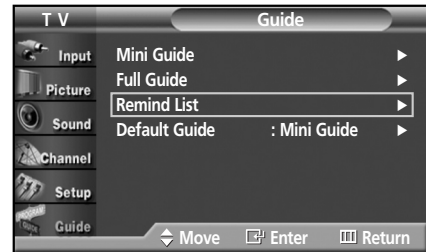

To remove the scheduled programs

- 1 Press the ▲ or ▼ button to select a program to be removed, then press the ENTER button.

To remove all programs, press the ◀ or ▶ button to select "Cancel All", then press the ENTER button.

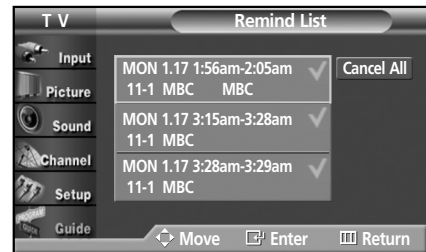

- 2 Press the EXIT button to exit.

S
A
M
S
U
N
G

P L A S M A D I S P L A Y P A N E L

Appendix 

Troubleshooting.....142
Care and Maintenance143
Specifications144
Dimensions.....145



Troubleshooting

If the TV seems to have a problem, first try this list of possible problems and solutions.
If none of these troubleshooting tips apply, then call your nearest service center.

Problem	Possible Solution
Poor picture.	Check all wire connections.
No picture or sound.	Try another channel. Press the SOURCE button. Make sure the TV is plugged in. Check the antenna connections. Check that the Mute feature is Off. Check if Internal Mute is set to On.
Poor sound quality.	Try another channel. Adjust the volume.
Your remote control does not operate the TV.	Press the "MODE" button to put your remote control in the "TV" mode. Check the battery charge of the remote control.
The TV won't turn on.	Check if the power plug is connected.
There is no screen images.	Check to see that both the TV and the source are plugged in and turned on.
The image is too light or too dark.	Adjust the Brightness or Contrast settings.
The image is too large or too small.	Adjust the Size settings.
Digital broadcasting screen problem.	Please check the digital signal strength and input antenna.
Screen is black and power indicator light blinks steadily.	On your computer, check Power, Signal Cable. The TV is using its power management system. Move the computer's mouse or press any key on the keyboard. On your equipment check (STB, DVD, etc) ; Power, Signal Cable. The TV is using its power management system. Press the Source button on the panel or remote control. Turn the TV off and on.
The visual qualities of digital channels vary.	The visual qualities of digital channels may vary depending on the original production method (analog or digital). → If the original production method is digital: High quality visual program. → If the original production method is analog: The digital program displayed on the screen is originally an analog program which has been converted. The visual quality is of an SD grade.
Although the TV caption shows HD, the visual quality is not satisfactory.	The HD caption that appears when switching channels or when pressing the Information button on the remote control means the selected channel is simply a digital channel. If the broadcasting station converts an analog signal into digital and transmits the signal, the visual quality may not be perfect.



Care and Maintenance

With proper care, your TV will give you many years of service. Please follow these guidelines to get the maximum performance from your TV.

Identifying Problems

- Do not put the TV near extremely hot, cold, humid or dusty places.
- Do not put the TV near appliances that create magnetic fields.
- Keep the ventilation openings clear.
- Do not place the TV on a rough and slanted surface, such as cloth or paper.

Liquids

- Do not place liquids near or on the TV.

Cabinet

- Never open the cabinet or touch the parts inside.
- Wipe your TV with a clean, dry cloth. Never use water, cleaning fluids, wax, or chemicals.
- Do not put heavy objects on top of the cabinet.

Temperature

- If your TV is suddenly moved from a cold to a warm place, unplug the power cord for at least two hours so that moisture that may have formed inside the unit can dry completely.



Specifications

Exterior design and product specifications are subject to change without prior notice to improve the performance of this product.

Model		HP-R6372
Dimensions	Display	59.3 (W) x 39.0 (H) x 3.9 (D) inches (Without Stand)
		59.3 (W) x 41.4 (H) x 16.2 (D) inches (With Stand)
Weight	Display	74.3 Kg / 163.8 lbs (Without Stand)
		87.0 Kg / 191.8 lbs (With Stand)
Voltage		AC 110-120V~, 60Hz
Power Consumption		570 W
Number of Pixels		1366 (H) x 768 (V)
Screen Size		63 inches (159cm)
ANTENNA input		ANT 1 - CABLE IN (Cable QAM) ANT 2 - AIR IN ※ 75Ω unbalanced
VIDEO input		AV1, AV2 S-VIDEO1, S-VIDEO2 COMPONENT1 - 480i/480p/720p/1080i COMPONENT2 - 480i/480p/720p/1080i PC HDMI (DVI Compatible)
AUDIO input		AV1, AV2 S-VIDEO1, S-VIDEO2 COMPONENT1 - 480i/480p/720p/1080i COMPONENT2 - 480i/480p/720p/1080i PC DVI
Sound Output		AUDIO (L/R)
Audio Output		OPTICAL (DIGITAL OUT) COAXIAL (DIGITAL OUT)



Dimensions

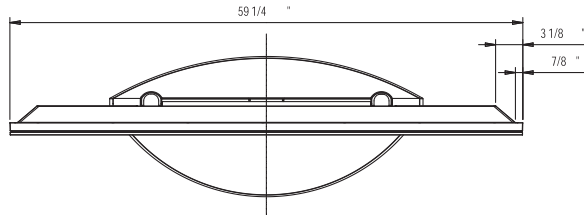

TOP VIEW

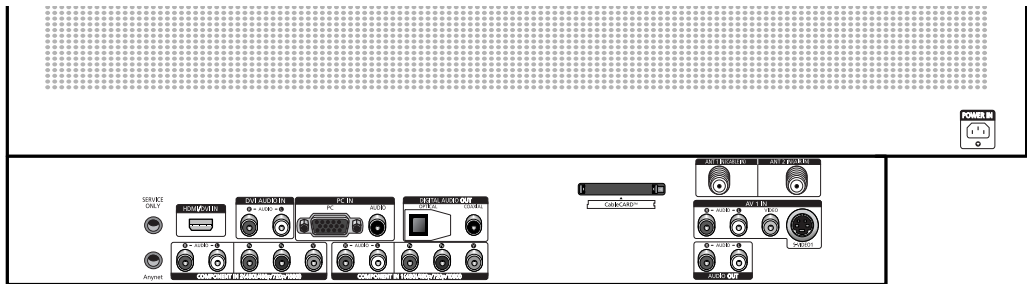

JACK PANEL DETAIL 2 5/16"H x 18 3/4"W @ 8 9/16" UP FROM BOTTOM

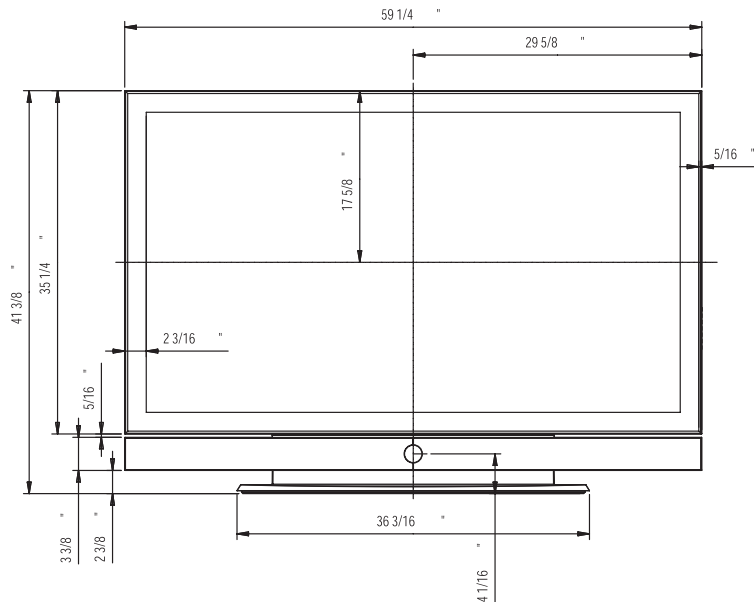

FRONT VIEW

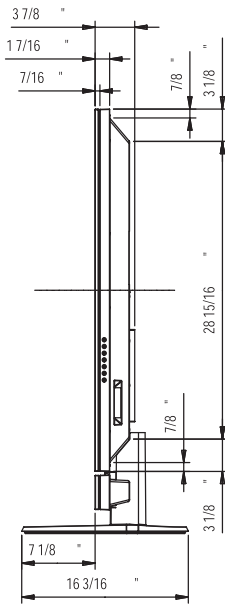

SIDE VIEW

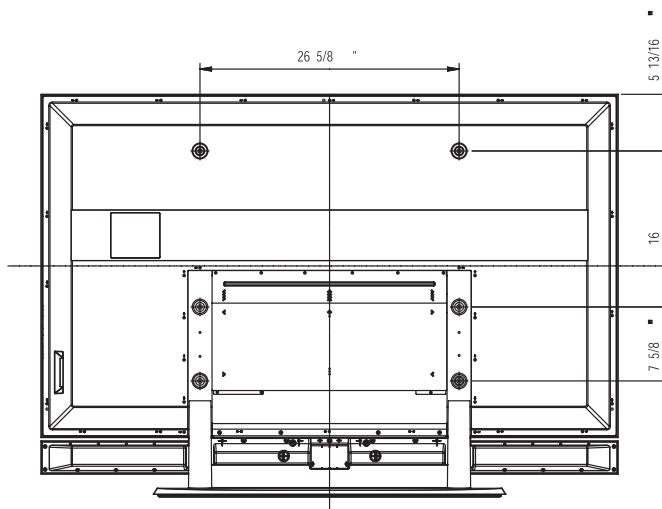

REAR VIEW

NOTE : All drawings not necessarily to scale. Some dimensions are subject to change without prior notice. Refer to dimensions on each unit prior to performing any carpentry. Not responsible for typographical or printed errors.

©2005 Samsung Electronics America, Inc.



Memo



ELECTRONICS

1-800-SAMSUNG (1-800-726-7864)

**Samsung Electronics America
Service Division**

400 Valley Road, Suite 201
Mount Arlington, NJ 07856
www.samsung.com

**Samsung Electronics Canada Inc.
Samsung Customer Care**

55 Standish Court
Mississauga, Ontario
L5R 4B2
www.samsung.ca