

ViewSonic®

**N3260w/N3760w/N4060w
LCD TV**

- User Guide
- Guide de l'utilisateur
- Guía del usuario



**Model No. : VS11436-1M
VS11437-1M
VS11438-1M**

Contents

Compliance Information	1
Important Safety Instructions	2
Copyright Information.....	3
Product Registration.....	3
Antenna Installation Instructions	4
Cleaning the LCD Display	4

Getting Started

Package Contents.....	5
Front View of the Product.....	6
Rear View of the product.....	7
Remote Control	8
Notes on the Remote Control	10
Key “Default”	11
Basic Setup	12
AUX Key Setup	13
Preprogrammed Code Table	14
Remote Control Battery Installation	20
Cable Connection.....	21

OSD Functions

Picture Adjustment	23
Image Adjustment	24
Source Adjustment.....	25
Setup Adjustment.....	26
Audio Adjustment	28
Tuner Adjustment.....	29
V-Chip Adjustment	30

Appendix

Specification.....	32
Troubleshooting.....	34
Customer Support.....	35
Limited Warranty	36

Compliance Information

User Information for North America

Notice :Use the cables which are included with the unit or specified



HDMI, the HDMI logo and High-Definition Multimedia Interface are registered trademarks of HDMI Licensing LLC.



is a trademark of SRS Labs, Inc.

TruSurround XT technology is incorporated under license from SRS Labs, Inc.



the Pixelworks DNK Technology™ LOGO is a trademark of Pixelworks, Inc.



Manufactured under license from Dolby Laboratories

“Dolby” and the double-D symbol are trademarks of Dolby Laboratories

Important Safety Instructions

1. Read these instructions completely before using the equipment.
2. Keep these instructions in a safe place.
3. Heed all warnings.
4. Follow all instructions.
5. Do not use this equipment near water.
6. Clean with a soft, dry cloth. If further cleaning is required, see “Cleaning the Display” in this guide for further instructions.
7. Do not block any ventilation openings. Install the equipment in accordance with the manufacturer’s instructions.
8. Do not install near any heat sources such as radiators, heat registers, stoves, or other devices (including amplifiers) that produce heat.
9. Do not attempt to circumvent the safety provisions of the polarized or grounding-type plug. A polarized plug has two blades with one wider than the other. A grounding type plug has two blades and a third grounding prong. The wide blade and the third prong are provided for your safety. If the plug does not fit into your outlet, consult an electrician for replacement of the outlet.
10. Protect the power cord from being tread upon or pinched, particularly at the plug, and the point where it emerges from the equipment. Be sure that the power outlet is located near the equipment so that it is easily accessible.
11. Only use attachments/accessories specified by the manufacturer.
12. Use only with the cart, stand, tripod, bracket, or table specified by the manufacturer, or sold with the equipment. When a cart is used, use caution when moving the cart/equipment combination to avoid injury from tipping over.
13. Unplug this equipment when it will be unused for long periods of time.
14. Refer all servicing to qualified service personnel. Service is required when the unit has been damaged in any way, such as: if the power-supply cord or plug is damaged, if liquid is spilled onto or objects fall into the unit, if the unit is exposed to rain or moisture, or if the unit does not operate normally or has been dropped.

Copyright Information

Copyright © ViewSonic® Corporation, 2006. All rights reserved.

ViewSonic®, the three birds logo, OnView, ViewMatch, and ViewMeter are registered trademarks of ViewSonic Corporation.

Disclaimer: ViewSonic Corporation shall not be liable for technical or editorial errors or omissions contained herein; nor for incidental or consequential damages resulting from furnishing this material, or the performance or use of this product.

In the interest of continuing product improvement, ViewSonic Corporation reserves the right to change product specifications without notice. Information in this document may change without notice.

No part of this document may be copied, reproduced, or transmitted by any means, for any purpose without prior written permission from ViewSonic Corporation.

Product Registration

To meet your future needs, and to receive any additional product information as it becomes available, please register your product on the Internet at: www.viewsonic.com.

For Your Records

Product Name:	N3260w / N3760w / N4060w ViewSonic LCD TV
Model Number:	VS11436-1M / VS11437-1M / VS11438-1M
Document Number:	N3260w_N3760w_N4060w-2M_UG_ENG Rev. 1A 05-11-06
Serial Number:	_____
Purchase Date:	_____

Product disposal at end of product life

ViewSonic® is concerned about the preservation of our environment. Please dispose of this product properly at the end of its useful life. Your local waste disposal company may provide information about proper disposal.

The lamp in this product contains mercury. Please dispose of properly in accordance with environmental laws of your location.

Antenna Installation Instructions

1 Outdoor Antenna Grounding

If an outside antenna or cable system is connected to the product be sure the antenna or cable system is grounded to avoid voltage surges and built-up static charges. Article 810 of the National Electrical Code, ANS/NFPA 70, provides information with regard to proper grounding of the mast and supporting structure, grounding of the lead-in wire to an antenna discharge unit, connection to grounding electrodes, and requirements for the grounding electrode.

2 Lightning

For added protection for this product during a lightning storm, or when it is left unattended and unused for long periods of time, unplug it from the wall outlet and disconnect the antenna or cable system. This will prevent damage to the product due to lightning and power-line surges. Do not disconnect the antenna or the power cord during a heavy storm as lightning may strike while you are holding the cable cord, causing serious injury. Turn off your LCD and wait for the weather to improve.

3 Power Lines

An outside antenna system should not be located in the vicinity of overhead power lines or other electric light or power circuits. When installing an outside antenna system, extreme care should be taken to keep from touching the power lines or circuits as contact with them may be fatal.

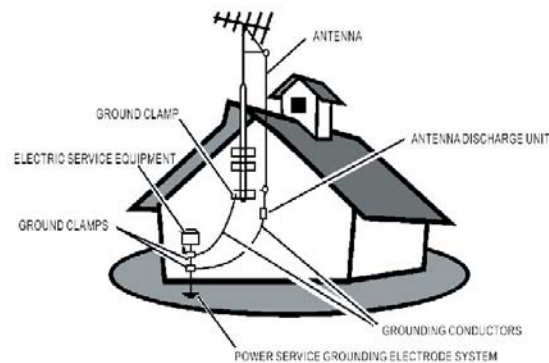

Cleaning the LCD Display

- Make sure the LCD Display is turned off.
- Never spray or pour any liquid directly onto the screen or case.

To clean the screen:

1. Wipe the screen with a clean, soft, lint-free cloth. This removes dust and other particles.
2. If still not clean, apply a small amount of non-ammonia, non-alcohol based glass cleaner onto a clean, soft, lint-free cloth, and wipe the screen.

To clean the case:

1. Use a soft, dry cloth.
2. If still not clean, apply a small amount of non-ammonia, non-alcohol based, mild non-abrasive detergent onto a clean, soft, lint-free cloth, then wipe the surface.

Disclaimer

ViewSonic does not recommend the use of any ammonia or alcohol-based cleaners on the LCD screen or case. Some chemical cleaners have been reported to damage the screen and/or LCD case. ViewSonic will not be liable for damage resulting from use of any ammonia or alcohol-based cleaners.

Getting Started

Congratulations on your purchasing of a ViewSonic LCD TV display. Important! Save the original box and all packaging material for future shipping needs.

Package Contents

Please confirm that the following accessories are present when you unpack the box:

- LCD TV
- Remote Control (batteries included)
- Power Cord(S)
- AV Cable
- User Guide
- Color Quick Start Guide

Front View of the Product

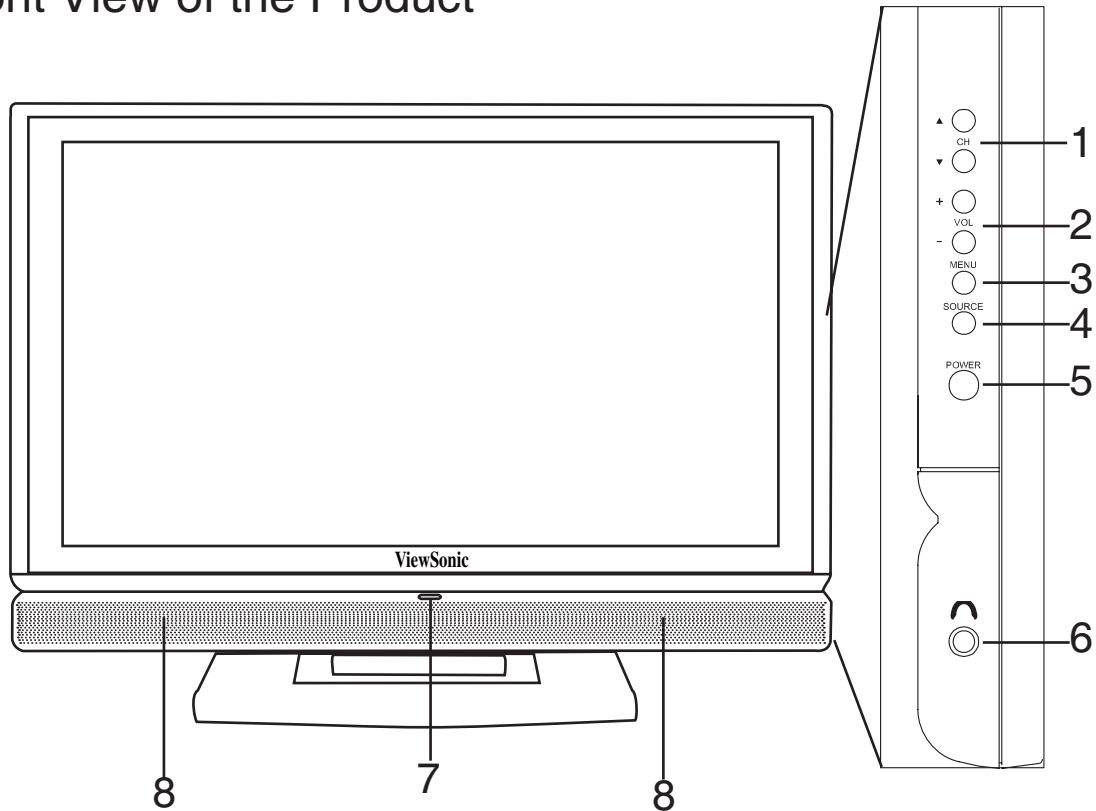

- 1** CH ▲/▼
Changes the channel.
- 2** VOL +/-
Used for changing the volume.
- 3** MENU
Display menu screen.
- 4** SOURCE
Switch between display input sources.
- 5** POWER
Turns the TV ON (green light) and OFF (red light).
- 6** EARPHONE
Used for connecting headphones to the TV.
- 7** POWER INDICATOR LED
Indicates if the power is turned on (green), or if the TV is in stand-by mode (red). DPMS state for RGB/HDMI (red) (DPMS state only in pc mode)
- 8** SPEAKERS
Audio output.

Power Lock

Press MENU and VOL + buttons at the same time can lock the function of POWER button.

OSD Lock

Press VOL - and VOL + button at the same time can lock the function of MENU button.

Rear View of the Product

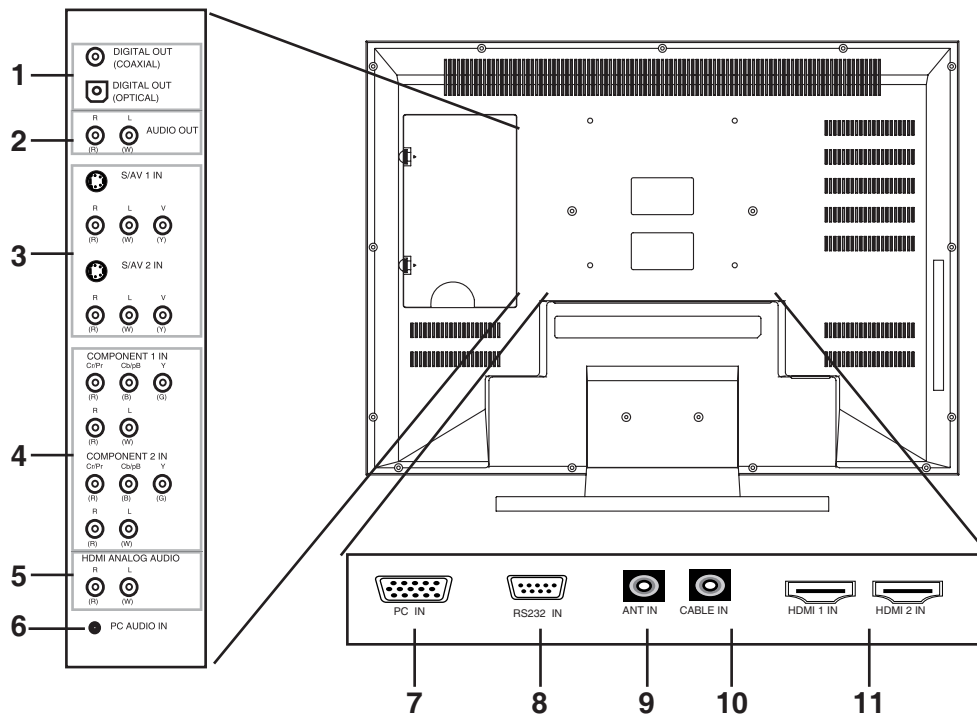

- 1** **DIGITAL OUT**
Connects to audio device which with RCA jack by coaxial or optical audio cable .Sound track will be 5.1 channel in DTV system when channel support and in analogy TV system, sound track will be stereo output.
- 2** **AUDIO OUT**
Connects to the A/V device audio input .
- 3** **S/AV IN**
Connects to the audio and S-Video or video output jack of your A/V device.
- 4** **COMPONENT 1 /COMPONENT 2 IN**
Connects to the audio and component video output jack of your A/V device.
- 5** **HDMI ANALOG AUDIO – IN**
Connects to the A/V device input.
- 6** **PC Audio – IN**
Connects to the audio output(earphone jack) of your PC or portable computer.
- 7** **PC-IN**
Connects to your VGA output of your PC or portable computer.
- 8** **RS232-IN**
For manufacturer use only.Incorrect use may damage the system.
- 9** **ANT-IN**
Connects to your ATSC antenna or cable from a local TV.
- 10** **CABLE – IN**
Connects to your coaxial cable from local TV.
- 11** **HDMI 1/HDMI 2 IN**
Connect to your HDMI output of A/V device.

Remote Control

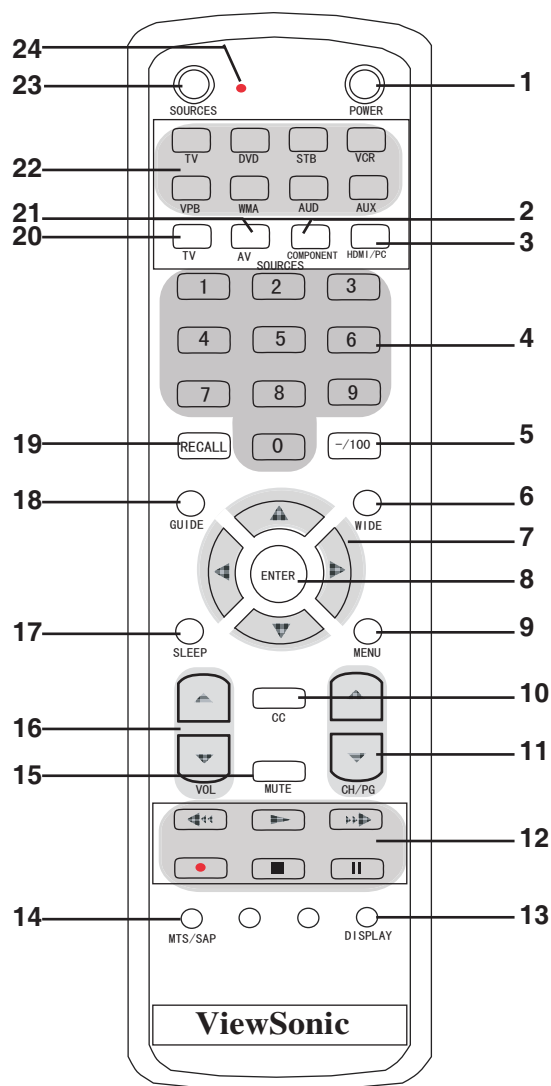

- 1 POWER**
Turns power on or off.
- 2 COMPONENT**
Switches the source to HD1/HD2 mode .
- 3 HDMI/PC**
Switches the source to HDMI/PC mode.
- 4 NUMBER KEYS**
Press the number keys to enter channel numbers.
- 5 -/100 (100)**
Press the key to choose a channel number .In AIR mode, press this key as “-”
For example ,you want to select channe 1-12,press 1 number key and “press”
-/100” key then press 1 and 2 .
In CABLE mode , press this key as ”100”.
- 6 WIDE**
Switches the display mode between various wide modes.

- 7** **ARROW KEYS**
Press the ▲▼◀▶ keys to scroll through the OSD menu options.
- 8** **ENTER**
Press this button to execute the order you choose.
- 9** **MENU**
Displays the OSD menu. Press repeatedly to view the different menu pages or exit the OSD menu.
- 10** **CC**
Press to call the Closed Caption (CC) list.
- 11** **CH▲▼**
Increases▲ or decreases▼ the channel number.
- 12** (These function available on other devices).
- 13** **DISPLAY**
Press repeatedly to display channel number or name of input source.
- 14** **MTS/SAP**
Press to select from SAP, MONO or Stereo mode.
- 15** **MUTE**
Disables the audio output.
- 16** **VOL ▲▼**
Volume increases▲ or decreases▼ .
- 17** **SLEEP**
Press repeatedly to set the off timer from 10 to 240 minutes. The TV enters stand-by mode after the specified time interval.
- 18** **GUIDE**
Press to display the program list of Digital TV.
- 19** **RECALL**
Switches to the previously viewed channel.
- 20** **TV**
Switches the source to TV mode.

21 AV

Switches the source to AV mode.

22 (These function available on other devices)

*If remote control unit does not operate,you may try press TV key to reset the setting of remote control.

23 SOURCES

Selects the TV,AV/S,HDTV,PC/HDMI inputs as the video source signal.

24 REMOTE INDICATOR LIGHT

When using remote control,the indicator light will be in red.

Notes on the Remote Control

- The remote control's effective range is 5 meters from the LCD screen at an angle of up to $\pm 30^\circ$.
- Direct light may affect the remote controls effective range.
- Avoid subjecting the remote control to shocks or vibrations.
- Avoid placing the remote control in humid and hot environments such as direct sunlight.
- Remove the batteries when not using the remote control for long periods.

Key “Defaults”

The “default” out of box setting enables the Remote to control a predetermine TV,DVD,STB,VCR,WBA and AUD.

Depending on Device desire the following model will be active:

Device	Default Setting
TV	ViewSonic
DVD	Samsung
STB	RCA
VCR	Sony
VPB	Viewsonic
WMA	Viewsonic WMA-100
AUO	Sony

Note :Multiple pre-progeammed codes are available for some devices;if default setting does not funtion,see pre-programmed table for additional codes.

Resetting Remote

□To reset remote and access default settings press and hold desire device button for roughly six seconds and enter three digit reset code 000.

□Replace batteries if remote control keys are not functioning properly,this is a normal behavior that indicates batteries are low.



Basic Setup

1. Power on the A/V component you wish to setup, so that you can test codes by sending power off commands.
2. Refer to the Pre-programmed code tables and write down the code number listed.
3. Press and hold the button for the desired device for approximately six seconds. The top LED will turn on, enter pre-programmed code. LED will blink to indicate pre-programmed code was captured correctly.



Pre-Programmed Code Note

Record the three digital codes for your device here:

TV _____	VPB _____
DVD _____	WMA _____
STB _____	AUD _____
VCR _____	AUX _____

AUX Key Setup

The AUX key is used to operate a second TV,DVD,STB,VCR,VPB,WMA and AUD.A fourth digital is necessary to identify the type of device the key will control..



TV=1	VPB=5
DVD=2	WMA=6
STB=3	AUD=7
VCR=4	

For example, to control a SONY DVD player with a code of 027 undet the AUXkey a 2 must be added in the beginning of the pre-programmed code making it 2027.If user wants to control a PHILIPS STB with a 006 code under the AUX key a 3 must be added in the beginning of the preprogrammed code making it 3006

To enter the pre-programmed code press and hold the AUX button for approximately six seconds.The top LED will turn on ,enter the preprogrammed code with the first digital to indicate the type of device.LED will blink to indicate pre-programmed code was captured correctly.



Preprogrammed Code Table

ViewSonic LCD TV's and Plasmas

BRAND	CODE
Aiwa	001, 033, 051, 118
Aiba	002, 037
Apex	046, 059, 060, 062, 063, 084, 085, 086
Audiovox	119
Blaupunkt	104, 123
Bose	113, 117
Broksonic	052
Bush	003
Clarion	097
Classic	098
CyberHome	004, 005
Daewoo	006, 124, 125
Dansai	007
Denon	034, 120, 140, 141
Emerson	099, 100
Fisher	101, 121
Funai	100, 114
GE	064, 102, 146
Go Video	055, 057
Goodmans	038
GPX	103

Vi DVD Players-1 sm

BRAND	CODE
N1700W	001
N1300	002
N1500	003
N1750W	004
N2010	005
N2010-E	006
N2700W	007
N2750W	008
N3020W	009
N3200W	010
N3200W-E	011
VPW4255	012
VPW5500	012
N2000	014
N3000W	015

DVD Players-2

Grundig	008, 009
Harman Kardon	116
Hitachi	010, 054, 115
Irradio	137
JVC	011, 039, 066, 069, 070, 071, 072
Kenwood	031, 142, 145
Koss	138
LG	012, 040, 041
Magnavox	077, 091
Marantz	130
Memorex	132
Mintek	104
Mitsubishi	133, 134, 135, 136
Mustek	013, 035
NAD	012, 099, 126
Nakamichi	105
Norcet	106, 107
Onkyo	127, 131
Oritron	108
Panasonic	014, 015, 016, 017, 032, 067, 092, 093
Phillips	018, 019, 061, 068, 078, 079, 080, 096
Pioneer	020, 083, 088
Proscan	064, 144
Qwestar	108
RCA	064, 081, 094
Sampo	109
Samsung	000, 021, 042, 047, 049, 065, 089
Sansui	111
Sanyo	023, 036, 053, 110
Scott	024
SEG	025, 043
Sharp	026, 043
Sherwood	112
Sony	027, 028, 044, 074, 075, 090, 095
Sylvania	058, 100, 122
Techwood	128
Thomson	022
Toshiba	029, 045, 048, 050, 076, 082
Yamaha	030, 092, 129, 143
Zenith	056, 139

STB-Set Top Box

BRAND	CODE
Akai	019
Alba	005, 006, 007
Allsat	019
Alphastar	057
Amstrad	001
Ankaro	012
Anttron	005
Apollo	005
Armastrong	010
Asat	019
Astra	010, 013
Astro	007, 008, 012, 015
AudioTon	007
Best	012
Blaupunkt	015
Brain Wave	016
BSkyB	001
Bush	006, 017
Chaparral	054
CityCom	006
Clatronic	016
Condor	012
Crown	010
Daeryung	014
Dish Network	038
DNT	014, 019
Drake	056
Echostar	014, 021, 038, 055
Einhell	005, 010
Elta	005, 012
Emme Esse	012, 017
Ep Sat	006
Eurosat	010
Eurosky	010, 012
Eurostar	010
Express Vu	038
Ferguson	006, 017, 025
Finlandia	006
Finlux	006, 013
Fuba	005, 012, 014, 015, 019
Fujitsu	052
Galaxis	012
GE	031, 040, 041
General Instruments	048, 049
GMI	010
Goodmans	006
Granada	013

Grundig	001, 006, 007, 015, 017, 024
Hanseatic	018
Hirschmann	015
Hisawa	016
Hitachi	006, 017, 053
Hughes	053
Huth	010, 016
Intertronic	010
Janeil	052
Johansson	016
JVC	045
Kathrein	015, 019, 026
KR	007
Kreiselmeier	015
Kyostar	005
Lasat	008
Lenco	005
Luxor	013
Macab	025
Manhattan	006, 008, 017
Marantz	019
Mascom	008
Maspro	006, 017
Mediamarkt	010
Medion	012, 018, 021, 022
Metronic	005, 007, 008, 028
Metz	015
Minerva	015
Mitsubishi	006, 015, 030
Morgan's	010, 019
Nikko	010
Nokia	006, 013, 017, 020
Nordmende	005, 006, 008, 025
Novis	016
Octagon	005, 007
Okano	010
Orbitech	005
Otto Versand	015
Pace	001, 006, 015, 017
Palladium	010
Panasonic	001, 006, 017, 032, 034
Panda	006
Philips	006, 011, 017, 019, 023, 029, 058
Phonotrend	006
Predki	016
Proscan	040, 041
Provision	008
Quadral	012

Quelle	015
Radio Shack	048, 049
Radiola	019
Radix	014
RCA	000, 040, 041
Realisitic	044
RFT	019
Saba	008, 017
Sabre	006
Sagem	025
Salora	013
Samsung	005, 035, 057
Satcom	016, 018
SatPartner	005, 007, 008, 016
Schneider	012, 021, 022
Seemann	010, 014
SEG	005, 009, 012, 016, 018
Siemens	015
Skymaster	018, 021, 022, 027
Sony	043, 059
Star Trak	051
Strong	005, 007, 012
STS	050
Sunstar	010
Tandberg	025
Tandy	007
Tantec	006, 017
TechniSat	014
Teco	010
Telasat	018
Telefunken	005, 017
Teleka	007, 010, 014
Telemaster	008
Telesat	018
Televés	006
Thomson	002, 003, 004, 006, 025
Thorn	006, 017
Tonna	006
Toshiba	036, 042
Triax	015
Uniden	046, 047
Unisat	010
Unitor	016
Universum	015
Visiosat	016
Vortec	005
Wewa	006
Womersat	016
Wisi	006, 014, 015
Zehnder	008, 012, 028
Zenith	033, 037, 052

Cable

BRAND	CODE
ABC	006, 067, 069, 105
Archer	072, 073
Cabletime	060
Contec	078
Eastern	079
France Telecom	061
GE	066
Gemini	080, 081
General Instrument	066, 107
Grundig	062
Hamlin	082, 083, 084, 089, 106
Hitachi	066
Jerrold	066, 080, 085, 086, 101, 105, 107
Magnavox	087
Motorola	108
NEC	068
Nokia	063
Panasonic	102, 104
Philips	064, 074, 075, 076, 077, 081, 087, 091, 092, 093
Pioneer	094, 095
Proscan	066
RCA	070, 104, 107
Realistic	072
Sagem	065
Samsung	095
Scientific Atlanta	069, 096, 097, 098
Signature	066
Sprucer	104
Starcom	080, 105
Stargate	080
Tocom	067, 085
United Cable	105
Universal	071, 072, 073
Zenith	103

VCR

BRAND	CODE
Action	102
Admiral	101, 144, 145
Aiko	127
Aiwa	005, 126
Audiovox	122
Bell & Howell	119
Broksonic	059, 105, 120
Calix	122
Canon	124, 125
Capehart	083, 138
Carver	131, 151
CCE	127, 130
Citizen	095, 121, 122, 123, 127
Colortyme	096, 117
Craig	085, 090, 104, 121, 122, 130
Curtis Mathes	077, 079, 114, 117, 121, 124, 125, 150
Daewoo	006, 007, 083, 102, 123, 126, 127, 138
Daytron	083, 102, 138
Denon	088
Dimensia	114, 150
Electrohome	090, 122
Emerson	087, 090, 105, 115, 120, 122, 123, 124, 126, 132, 140
Fisher	089, 104, 119
Fuji	116, 124
Funai	095, 126
Gerrard	126
GE	065, 079, 081, 087, 114, 121, 124, 125, 141, 150
Go Video	054, 056, 071, 072, 074, 079, 081, 085, 086
Goldstar	079, 090, 092, 117, 122
Gradiente	090, 126
Harman Kardon	117, 151
Harwood	130
Hitachi	008, 009, 053, 062, 063, 088, 128, 129, 136, 139, 141
JBL	098

JC Penney	079, 085, 088, 090, 117, 118, 119, 120, 121, 122, 124, 125, 128, 129, 130, 131, 136
Jensen	128, 129, 139
JVC	010, 011, 040, 043, 058, 087, 088, 117, 118, 119, 139, 142
Kenwood	077, 117, 118, 119, 139, 142
KLH	130
Kodak	122, 124
LG	012, 013, 122
Lloyds	077, 095, 104
Loewe	037
Logik	085, 130
LXI	122
Magnasonic	085, 090, 102
Magnovox	069, 085, 124, 125, 131, 135
Marantz	077, 092, 117, 118, 119, 124, 131, 151
Matsushita	124
Memorex	073, 088, 090, 091, 097, 104, 119, 121, 122, 124, 126, 135, 144, 145
MGA	132, 140
MGN	079
Minolta	088, 128, 129, 136
Mitsubishi	014, 066, 068, 090, 128, 129, 132, 140, 142, 152
Montgomery Ward	144, 145
Motorola	124, 144, 145
MTC	085, 121
Multitech	121, 126, 130
NEC	077, 092, 117, 118, 119, 139, 142
Nikko	122
Noblex	121
Olympus	124
Optimus	090, 094, 122, 144, 145
Optonica	133
Orion	087, 090, 105
Panasonic	015, 016, 017, 018, 019, 020, 021, 037, 044, 067, 070, 085, 090, 104, 105, 124, 125, 137

Pentax	077, 088, 128, 129, 136, 141
Philips	022, 023, 024, 025, 026, 027, 076, 110, 111, 124, 131, 133, 151
Pioneer	078, 103, 118, 128, 142, 146
Portland	083, 138
Precision	102
Proscan	114, 150
Proton	085
Quasar	090, 124, 125
Radio Shack	090, 122, 133, 145
Radio Shack/Realistic	119, 121, 122, 124, 125, 126, 133, 144
Radix	122
RCA	048, 051, 078, 079, 088, 114, 115, 121, 124, 128, 129, 136, 141, 148, 149, 150
Realistic	079, 090, 094, 097, 104, 119, 121, 122, 123, 124, 125, 126, 133, 144, 145
Ricoh	143, 147
Runco	135
Saba	038, 039
Samsung	028, 029, 057, 060, 079, 095, 107, 109, 121, 123
Sansui	085, 118, 139, 142
Sanyo	030, 052, 089, 097, 104, 119, 121, 151
Scott	090, 120, 123, 132
Sears	077, 088, 089, 090, 097, 104, 119, 122, 124, 128, 129, 136
Sharp	041, 042, 049, 050, 091, 094, 101, 133, 144, 145
Shintom	085, 116, 129, 130
Signature	144, 145
Signature 2000	097, 101
Singer	085, 124, 130, 143, 147
Sony	000, 001, 002, 003, 004, 045, 075, 080, 082, 084, 098, 099, 116, 134
STS	124, 136
Sylvania	061, 112, 124, 125, 126, 131, 132, 151

Symphonic	077, 095, 104, 126
Tandy	119
Tashiko	122
Tatung	139
Teac	126, 139, 148
Technics	124, 137
Teknika	090, 122, 124, 126
Thomson	031, 032, 035, 036, 038
Tivo	113
Toshiba	033, 034, 046, 047, 100, 102, 104, 106, 123, 128, 132, 140
Totevision	090, 121, 122
Unitec	095
Unitech	121
Vector Research	077, 117, 118, 123
Video Concepts	077, 117, 118, 123, 140
Wards	079, 090, 091, 094, 104, 121, 122, 123, 124, 126, 128, 129, 130, 133, 136, 144, 145, 149,
White Westinghouse	095
XR-1000	124, 126, 130
Yamaha	077, 117, 118, 119, 139
Zenith	055, 064, 090, 093, 116, 135, 143, 147

VPB

BRAND	CODE
Next Vision N4	001
Next Vision N5	002
Next Vision N5-2	006
Next Vision N5-2E	007
Next Vision N6	003
Next Vision HD10	004
Next Vision HD12	005

WMA

BRAND	CODE
WMA100	013

AUD

BRAND	CODE
Aiwa	024, 041, 063
Akai	013
Bose	039
Carver	075
Curtis Mathes	065
Denon	001, 053, 054, 059, 076
Fisher	005, 066, 068, 073
GE	030
Goodmans	013
Gradiente	086
Harman Kardon	002, 025, 052, 070
Hitachi	003, 083
JBL	025
Jensen	085
Jerrold	026, 028
JVC	004, 050, 057
Kenwood	005, 055, 058, 072, 080
Luxman	088
Marantz	042
McIntosh	082
NAD	064
Nakamichi	078
NEC	064
Nikko	087
Onkyo	006, 044, 048, 079
Optimus	065, 071
Panasonic	032, 033, 051, 056, 062, 074, 091
Philips	007, 037, 038, 040
Pioneer	008, 035, 045, 049, 065, 069
Proscan	030
Quasar	074
Radio Shack	071
RCA	029, 030, 031, 034
RCA & Dimensia	019, 020, 021, 022, 023
Roadstar	013
Saisho	013
Samsung	009
Sansui	013, 081
Sanyo	066, 068
Scientific Atlanta	027
Sharp	010, 084
Sherwood	011, 071
Sony	000, 012, 046, 060, 067
Starcom	026
Technics	014, 043, 047, 074

Thomson	015, 016
Toshiba	036
Uher	013
Yamaha	017, 018, 061, 072, 077
Zenith	089

Remote Control Battery Installation

Follow the steps below to insert the batteries.

- 1 Open the remote control's rear battery compartment cover.
- 2 Insert two AAA batteries. Ensure that the positive and negative ends match as indicated on the bottom of the battery compartment.
- 3 Replace the battery compartment cover.

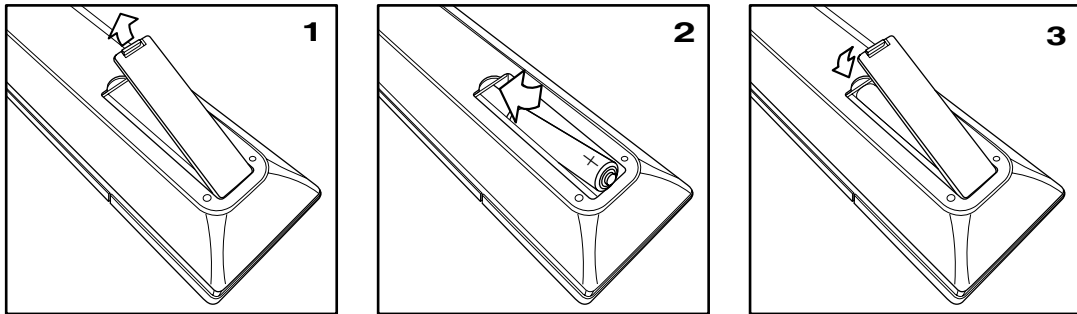

CAUTION

- Only use the specified AAA batteries.
- Do not mix new and old batteries. This may result in cracking or leakage, which may pose a fire risk or lead to personal injury.
- Insert batteries according to the (+) and (-) markings. Inserting the batteries incorrectly may result in cracking or leakage, which may pose a fire risk or lead to personal injury.
- Dispose of batteries in accordance with local laws and regulations.
- Keep batteries away from children and pets.
- If the remote control will not be used for an extended period of time, remove the batteries.

Cable Connections

Attach video and audio cables according to the connections on your external devices such as DVDs, VCR's, stereo systems.

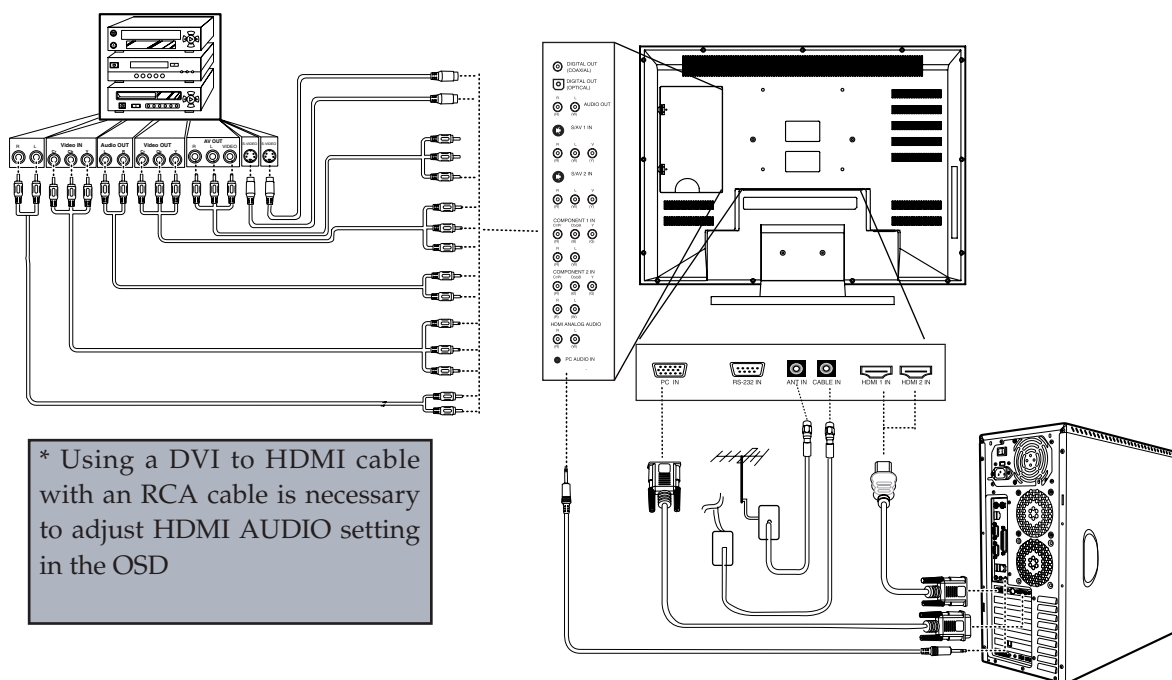

Power Cable Connection

- 1 Connect the power cable to a wall socket.
- 2 Connect the other end to the socket on the back of the LCD.

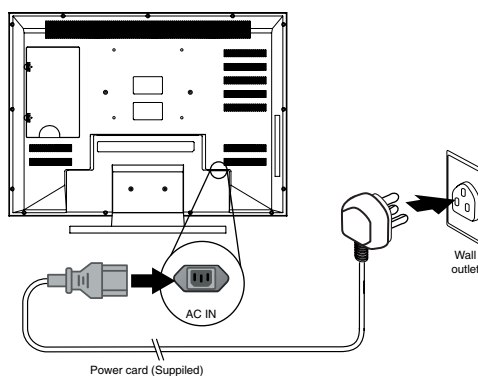

Turning the TV (Power) On

- 1 Press the power button. The power light will turn from red to green and the screen will appear after 5 seconds.
- 2 Press the power button again to turn it off.

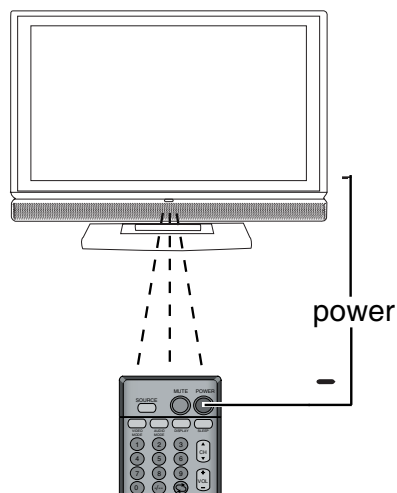

OSD Functions

All the functions for the LCD TV are controlled either by the remote control or the control buttons on the front control panel at bottom of the TV. See “Front View of the Product” on page6.

Press the **MENU** button on the remote control or the front control panel to display the OSD main menu.

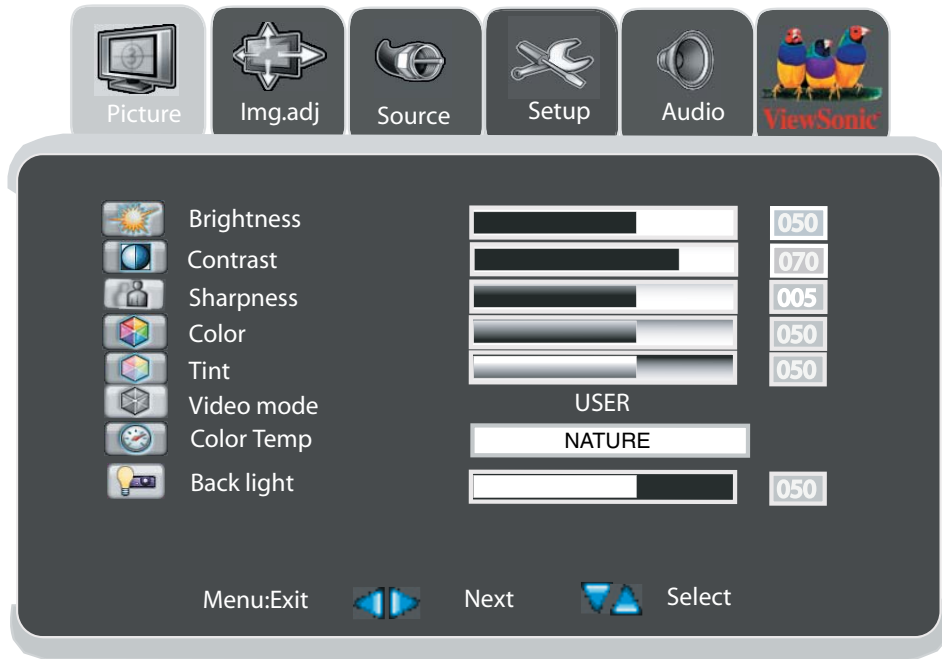

Press the **MENU** button to select the OSD menu you want.

Press the **CH ▲/▼** or the **▲/▼** buttons to select an OSD menu item.

Press the **VOL +/-** or the **◀/▶** buttons to change the values of the selected menu

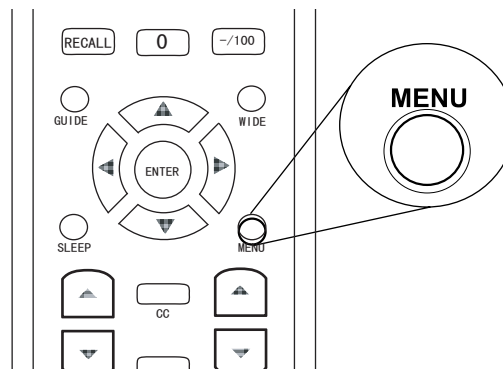

Press the **MENU** button to exit the OSD.

Picture Adjustment

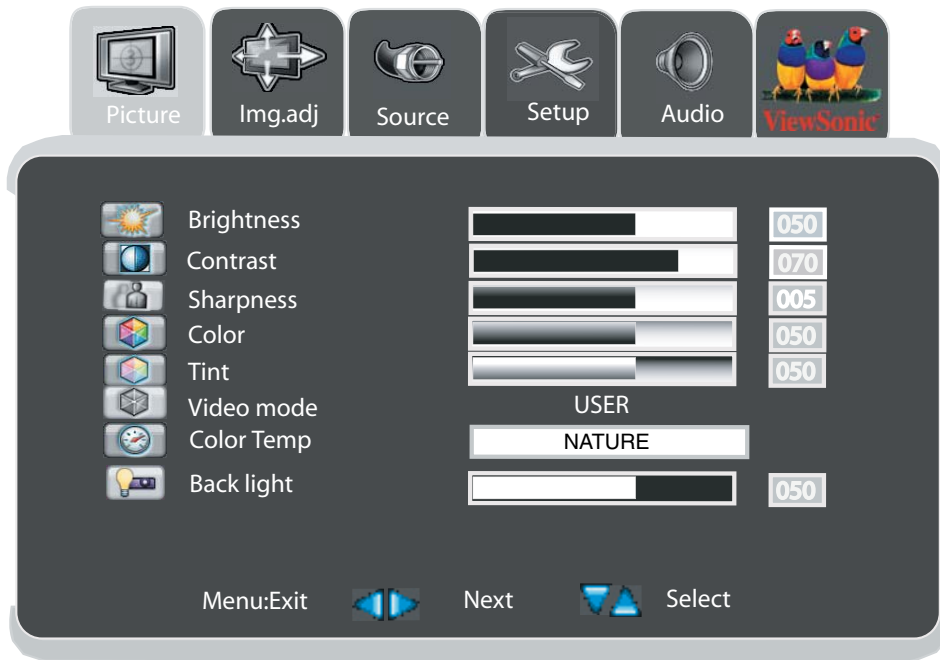

Function Name	Explanation
Brightness	Adjust the levels of light on your screen.It should be used in conjunction with the Contrast option.
Contrast	Adjusts the light levels on your display.It should be used in conjunction with the Brightness option.
Sharpness	Adjusts the sharpness levels on your screen.
Color	Changes the dominant color intensity on your screen. Adjust this setting until the colors on the screen(for example, flesh tones)look natural.
Tint (No support in PC mode)	Changes the color balance.Adjust this setting so that the colors(for example,flesh tones)on the screen are neither too green or too magenta.
Video Mode	Stores Picture settings. Following options are available: Soft : loads picture settings that result in softer colors and less sharp images. User : loads the most recent user defined settings. Preset : loads factory default settings.
Color Temp	Adjusts the image color intensity : nature,warm,cool,nomal.
Back Light	Adjusts the back light of OSD menu.
Phase (PC mode only)	Adjusts the phase of the display.
Frequency (PC mode only)	Adjust the frequency of your display .

Image Adjustment

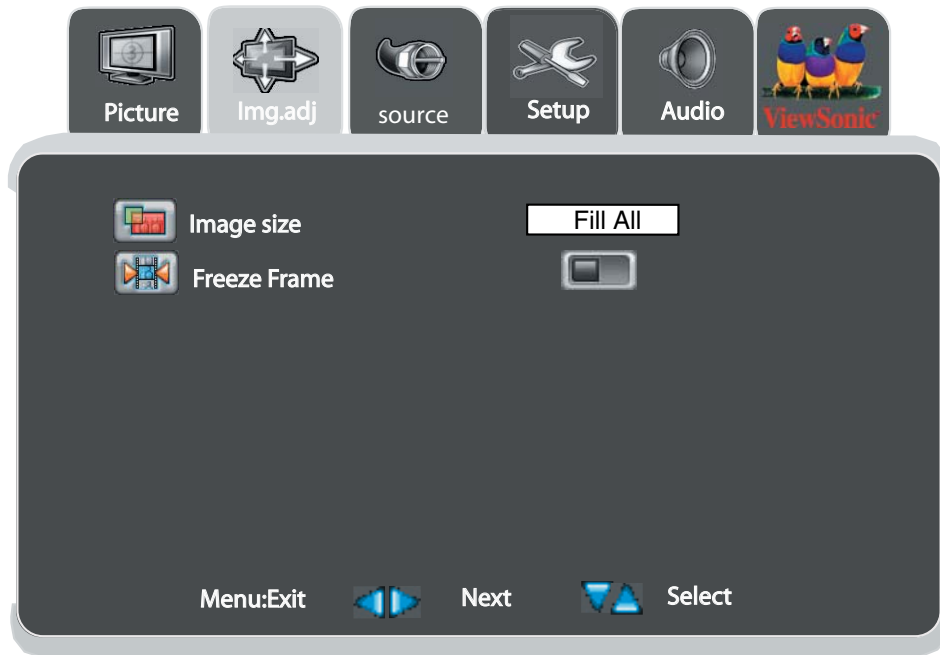

Function Name	Explanation
Image Size	Adjusts the image size include: Fill All , 1 to 1 , normal, wide, zoom, anamorphic, subtitle. In PC mode image size includes : Fill All , 1 to 1 , Fill Aspect.
Freeze Frame	Choose to freeze or un-freeze the frame on the screen. (Only support in PC mode).
H Position	Adjusts the horizontal position of display. (Only support in PC mode).
V position	Adjusts the vertical position of display. (Only support in PC mode).
Auto	Auto adjusts screen to the best position. (Only support in PC mode.)

Source Adjustment

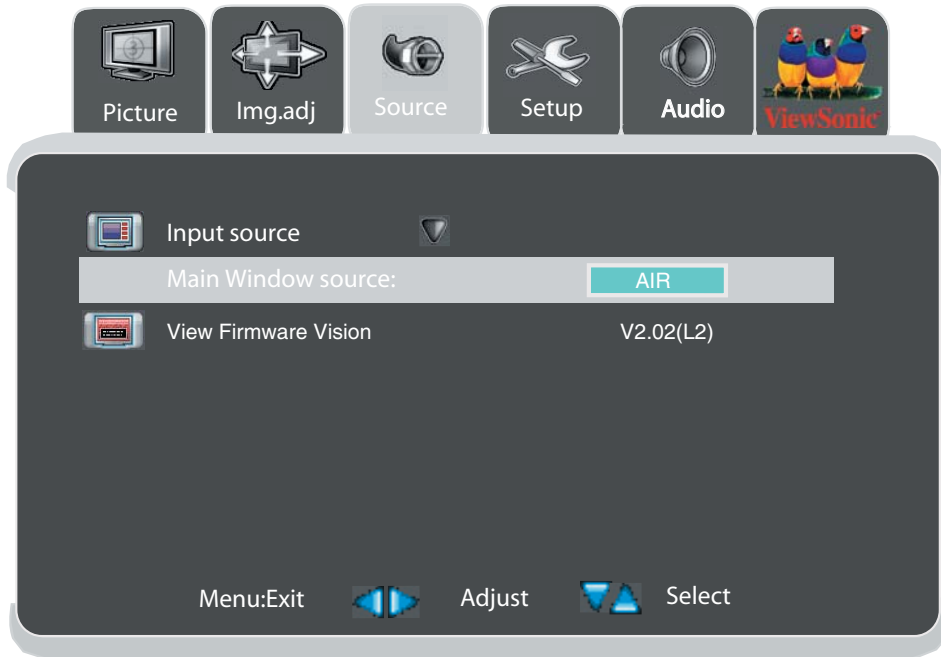

ENGLISH

Function Name	Explanation
Input Source	Select the source : Air,AV1,AV2,HD1,HD2,PC,HDMI 1,HDMI 2.
View Firmware Version	For manufacturer use..

Setup Adjustment

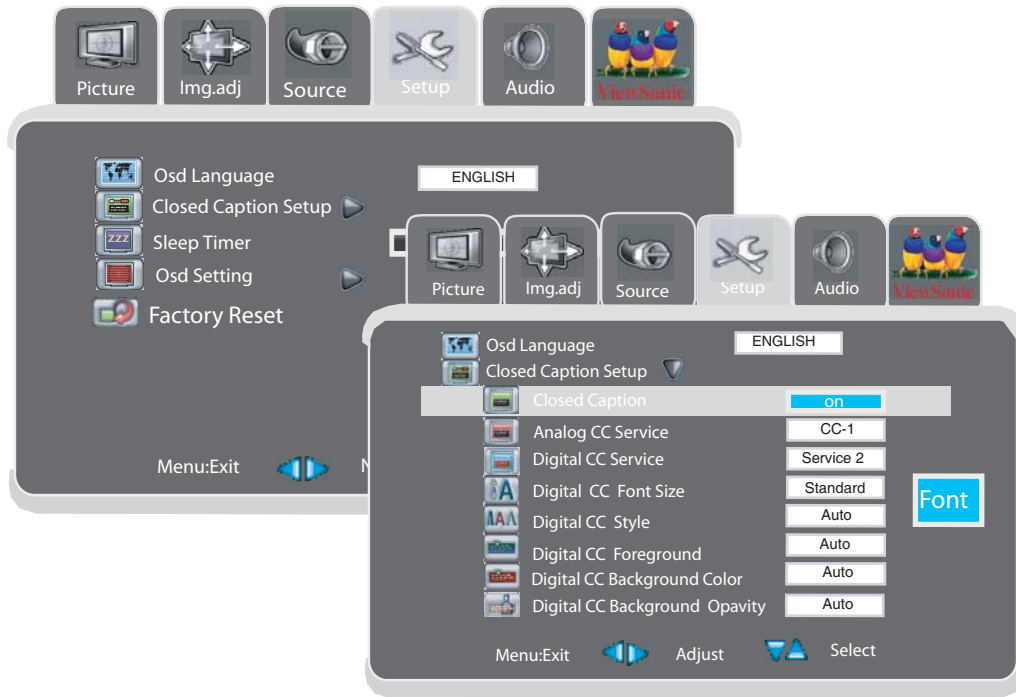

Function Name	Explanation
OSD Language	Adjust the OSD language ENGLISH,SPANISH,FRENCH.
Closed Caption Setup	Adjusts the setting of closed caption
Closed Caption	Adjust CC ON,OFF or when mute.
Analog CC Service	Choose the analog CC service :cc1,cc2,cc3,cc4,Tx1,Tx2, Tx3,Tx4
Digital CC Service	Choose the digital CC service : service 1-6
Digital CC Font Size	Choose the CC font : standard,small,large,auto.
Digital CC Style	Choose the CC style mode.
Digital CC Foreground	Choose the CC foreground color : black ,white,red,green, blue,yellow,magenta,cyan and auto.You can see the color sample showing on a square
Digital Background Color	Choose the CC foreground color : black ,white,red,green, blue,yellow,magenta,cyan and auto.You can see the color sample showing on a square
Digital Background Opacity	Adjust CC background opacity mode : auto,opaque,transparent. (NO support in PC,HDMI,HD mode)
DVI Only Mode	Adjust the screen range : Graphic(zoom in) or video (zoom out)(only in HDMI mode).

Note : When you select sources in OSD menu ,closed caption settings will be updated after exiting OSD menu.

Setup Adjustment

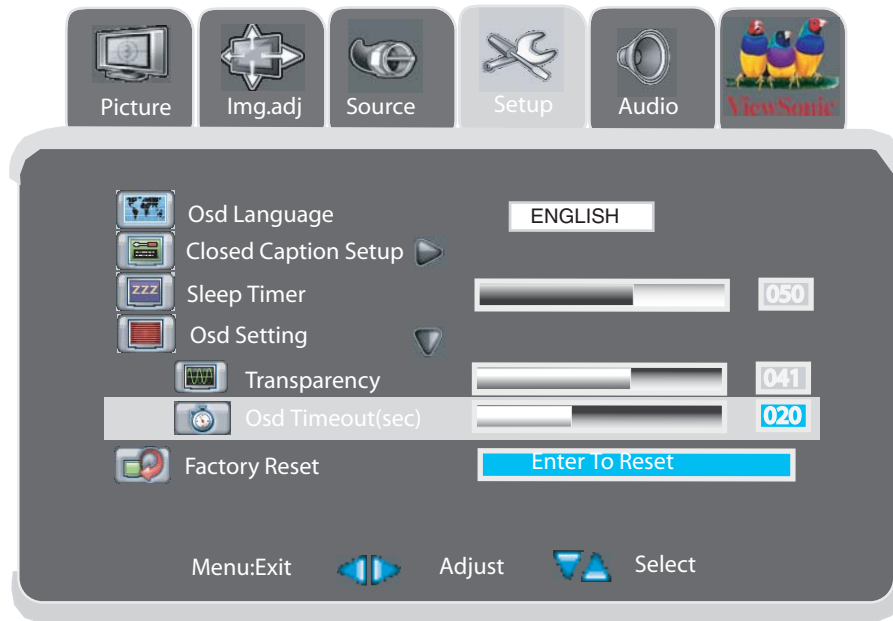

ENGLISH

Function Name	Explanation
Sleep Timer	Enable you to set off timer to 10 through 240min. That will elapse before the TV turns off.
OSD Setting Transparency OSD Timeout	Adjust the transparency rate OSD background. Adjust the stay time that OSD picture stay on screen.
Factory Reset	Back to the factory setting.

Audio Adjustment

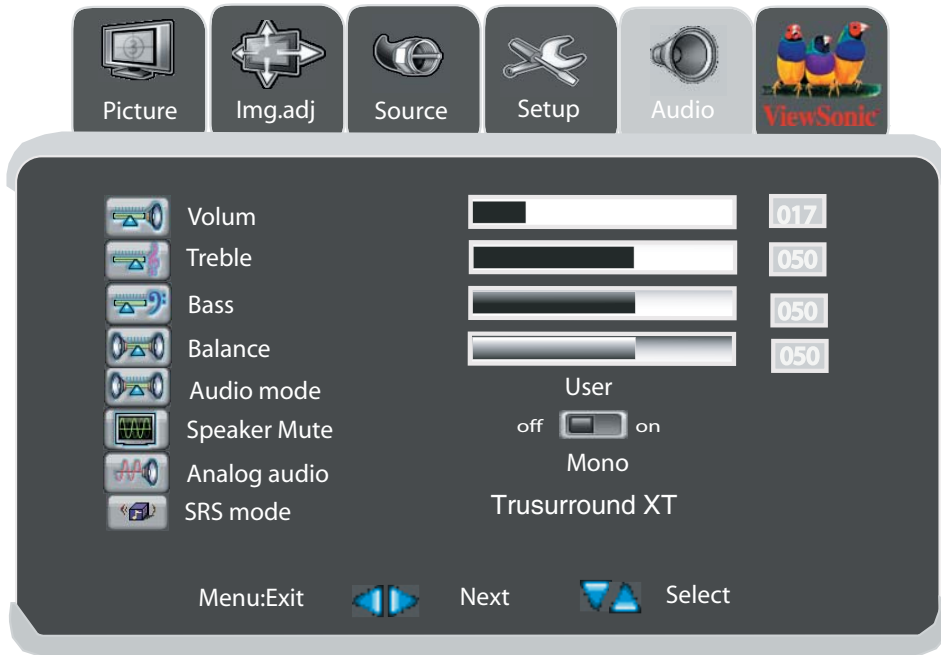

Function Name	Explanation
Volume	Adjusts the overall volume of the speakers..
Treble	Adjusts the high frequency content in the audio output.
Bass	Adjusts the low frequency content in the audio ouput.
Balance	Balance the volume of the left and right speakers.
Audio Mode	Stores Audio setting .The following options are available: Soft:loads audio settings that result in softer audio. User:loads the most recent user defined settings. Preset:loads factory default settings.
Speaker Mute	Disable the audio output.(When connect outside AMP)
Analog Audio	Adjusts analog audio setting items: Stereo,Sap,Mono.
SRS Mode	Switches SRS function on “TruSurround XT” or OFF.
HDMI Audio Source	Select the source in HDMI mode : HDMI,DVI and Auto. (HDMI mode only)

Tuner Adjustment

- TV mode only

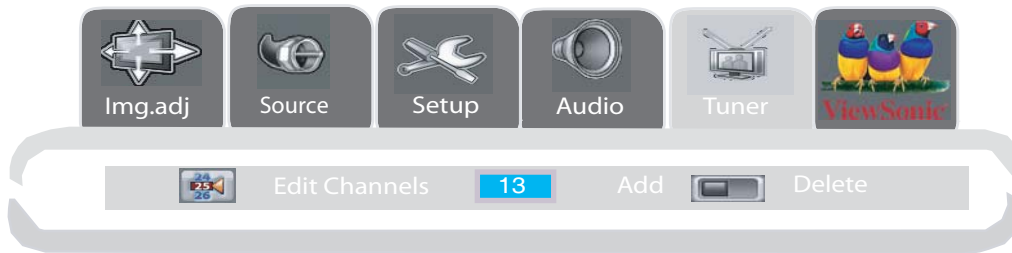
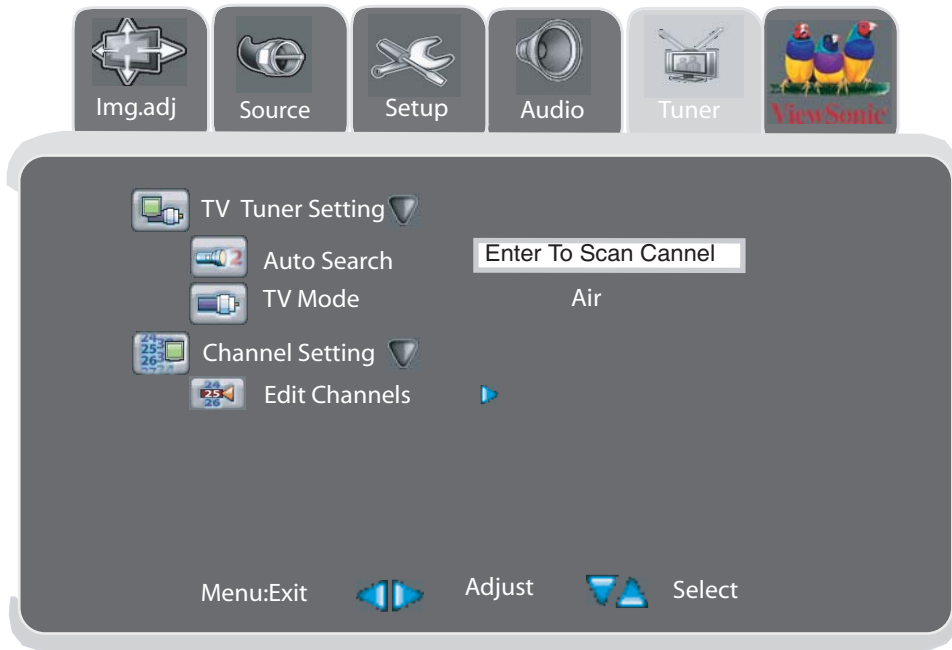

Function Name	Explanation
TV Tuner Setting	
Auto Search	Auto scan and record the ANT or cable channels
TV Mode	Select the tuner source : AIR,cable
Channel Setting	You can add or delete the channel in your channel list. Choosing a channel by ▲▼key or CH button and press ◀▶ key to add or delet channel..

ENGLISH

V-chip Adjustment

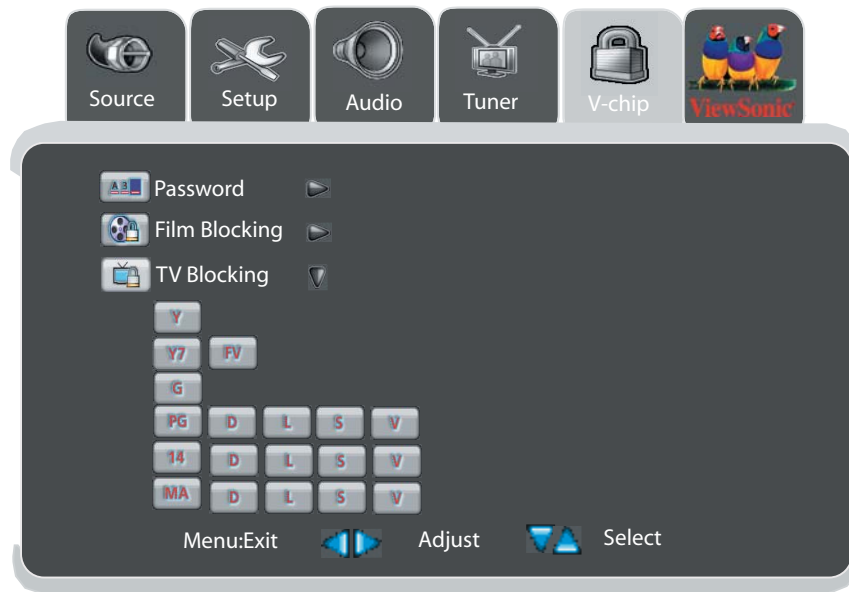
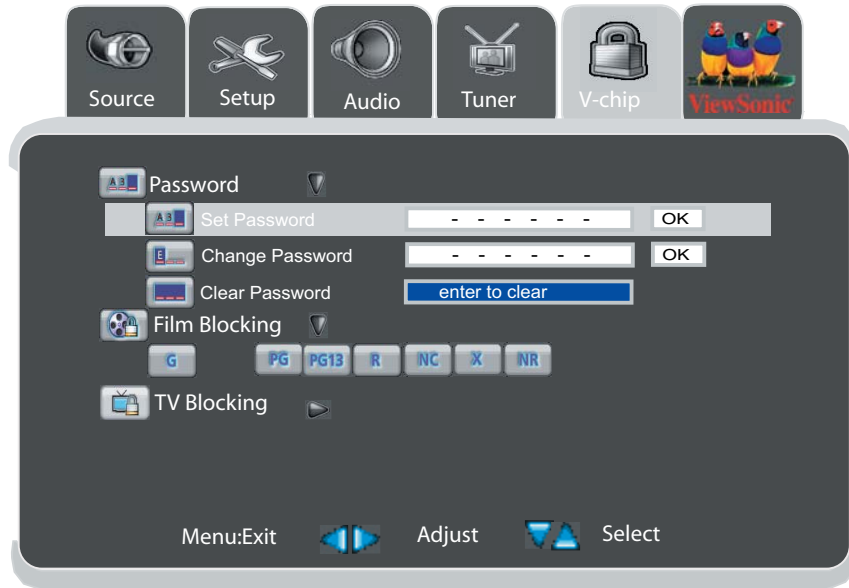

Function Name	Explanation
Password	<p>Access to parental control feature,you have to enter password.Factory default passwod is "000000".You may change or clear password.</p> <p>Select channel you want to block and choose the rate by arrow keys then press enter to setting.Blocked channels will not be output on screen</p> <p>(No support in HDMI and PC mode)</p>

MPAA Rating	Explanation
G(GENERALAUDIENCES)	Suitable for all ages.
PG(PARENTALGUIDANCE SUGGESTED)	Some material may not be suitable for children.
P G - 1 3 (P A R E N T A L STRONGLY CAUTIONED)	Some material may be inappropriate for children under 13
R(RESTRICTED)	Children under 17 are required to be accompanied by their parents or adult guardians.
NC-17	No-one 17 and under admitted..
X	X is an older rating that is unified with NC-17, but may be included in the date of older movies.
NR	Movies unrating

TV Guideline	Explanation
TV-Y	ALL Children(This program is appropriate for all children)
TV-Y7	Directed at older children(This program is designed for children aged 7 and above.Note : For those programs where fantasy violence may be more intense or more combative than other programs in this category,such programs will be designated TV-Y7-FV.).
TV-G	General Audience.(this program is suitable for all ages)
TV-PG	Parental Guidance Suggested.(This program contain material that maybe not suitable for younger children.) D)Some suggestive dialog L)Infrequent coarse language S)Some sexual aituations V)Moderate violence
TV-14	Parental Strongly Cautioned.(This program contain material that are not suitable for children under 14 years of age.) D)Intense suggestive dialog L)Strong coarse language S)Intense sexual situations V)Intense violence
TV-MA	Mature Audience only .(This program contains scenes that are not suitable for children under 17.) L)Graphic violence.Strong coarse language. S)Explicit sexual situations V)Graphic violence

Appendix

Specifications

Panel	Type	32" (full 31.5" viewable diagonal area) 37" (full 37.02" viewable diagonal area) 40" (full 39.9" viewable diagonal area) Active Matrix Wide-WXGA, 1366 x 768	
	Color	Anti-reflective coating + Anti-glare coating	
Viewing angles		32" 176° (H) / 176° (V)	
		37" 176° (H) / 176° (V)	
		40" 178° (H) / 178° (V)	
Connection Terminals	TV	AIR IN VHF/UHF :2-69 (ATSC/NTSC) CATV : 1-125 (NTSC)	
	S/AV	Video IN x 2 S-Video IN x 2 (S jack has priority when S-jack and Video-jack plug in the same time)Audio IN x 2	
	COMPONENT	COMPONENT Video x 2 (YCbCr/YPbPr)(support 480i,480p720p,1080i)Audio x 2	
	PC	VGA IN x 1 Audio IN x 1(3.5mm Jack) HDMI x 2 Audio IN x 1 (For HDMI Analog Audio)	
	Audio Out	Analog Audio Out x 1	
	Digital Audio Out	Digital Out (coaxial) x 1 Digital Out (optical) x 1	
Compatibility	Mode	Compatible Inputs	
		720 x 400 @ 70 Hz	PC,HDMI
		640 x 480 @ 60/75 Hz	PC,HDMI
		800 x 600 @ 60/75 Hz(VESA)	PC,HDMI
		832 x 624 @ 75 Hz (Mac)	PC,HDMI
		1024 x 768 @ 60/75 Hz (VESA)	PC,HDMI
		1280 x 720 @ 60 Hz (VESA)	PC,HDMI
		1280 x 768 @ 60 Hz	PC,HDMI
		1280 x 1024 @ 60 Hz (VESA)	PC,HDMI
		1360 x 768 @ 60 Hz	PC,HDMI
		480 I 60Hz(NTSC)	AV/S,HD
		480 P 60Hz(DVD)	HDMI
		720 P 60Hz	HDMI
		1080 I 60 Hz	HDMI
Speaker Output		10 W + 10 W	
Power	Voltage	100-240 VAC, 50/60 Hz (auto switch),	
		32":160W (MAXIMUN)	
		37":220W (MAXIMUN)	
		40":260W (MAXIMUN)	
Operating conditions	Temperature	0°C to 40°C (32°F to 104°F)	
	Humidity	10% to 90% (no condensation)	
	Altitude	To 3000 meters	

Storage conditions	Temperature	-20°C to 60°C (-4°F to 140°F)
	Humidity	10% to 90% (no condensation)
	Altitude	To 12,000 meters
Dimensions	Physical	32" : 820 mm (W) x 650 mm (H) x 230 mm (D) 32.3" (W) x 25.6" (H) x 9.1" (D)
		37" : 960 mm (W) x 730 mm (H) x 280 mm (D) 37.8" (W) x 28.7" (H) x 11" (D)
		40" : 1015 mm (W) x 755 mm (H) x 280 mm (D) 40.0" (W) x 29.7" (H) x 11" (D)
	Package	32" : 960 mm (W) x 780 mm (H) x 320 mm (D) 37.8" (W) x 30.7" (H) x 12.6" (D)
		37" : 1130 mm (W) x 870 mm (H) x 370 mm (D) 44.5" (W) x 34.3" (H) x 14.6" (D)
		40" : 1145 mm (W) x 910 mm (H) x 370 mm (D) 45.1" (W) x 35.8" (H) x 14.6" (D)
Weight	Net	32" : 22 kg (48.5 lb.)
		37" : 31 kg (68.3 lb.)
		40" : 33 kg (72.7 lb.)
	Gross	32" : 26.5 kg (58.4 lb.)
		37" : 38.5 kg (84.9 lb.)
		40" : 40.0 kg (88.1 lb.)
Regulations	FCC-B,c-UL,CB,NOM	
Power saving modes	Active Off	<1.5 W (Red LED)
Preset Timing Mode (Pre-adjusted to VESA 1360 x 768 at 60 Hz)		
Warning : Do not set the graphics card in you computer to exceed these refresh rates. Doing so may result in permanent damage to the LCD.		
Note : Product specifications are subject to change without notice.		

Troubleshooting

No power

- Make sure the LCD is properly connected. (see also pages 12)
- Make sure the AC power cord is properly connected. (see also page 12)
- Make sure the AC power is ON, DC power button is ON (Green LED).
- Plug another electrical device (like a radio) to the power outlet to verify that the outlet is supplying the proper voltage.

Poor or no picture

- The TV station may be experiencing problems. Try another channel.
- The Cable TV signal may be scrambled or encoded. Please contact your local cable operator.
- Make sure that connection to other components are correct. (see also pages 12)
- Make sure that setup has been done correctly after connections. (see also pages 13-16)
- Make sure the correct input is selected and the input signal is compatible.

Strange color, light color, or color misalignment

- Ensure that the video cable is securely connected.
- The picture may appear dim in a brightly lit room.
- Adjust brightness and contrast.
- Check the input signal setting.

No sound

- Check your audio connections
- The **MUTE** button may have been pressed, try pressing this button again.
- Check your audio settings, your TV audio may be set to minimum.
- Press the **Volume + (Up)** button on the remote control.

Remote control unit does not operate

- Make sure batteries are inserted correctly. (see also page 11)
- Batteries could be weak or dead. Replace batteries.
- Is a fluorescent light illuminated near the remote control sensor?
- The path of the remote control beam may be blocked. Make sure the path is clear and that the remote control is aimed at the remote control sensor on the TV.
- Press only one button at a time and it is the correct one for the operation you want to perform..

Unit cannot be operated

- External influences such as lightning or static electricity may cause improper operation. In this case, operate the unit after first turning on the power of the LCD and the AVC System, or unplug the AC cord for 1 to 2 minutes, then re-plug again.

Power is cut off suddenly

- Is the sleep timer set? (see also page 18)
- The internal temperature of the unit has increased. Remove any objects blocking the vent or clean as necessary.

No CATV reception (or no reception above CH13)

- Is the AIR/CABLE option set correctly? Please set the AIR/CABLE option to CABLE.
- CATV is connected improperly or not connected; please check all the CATV connections.
- The cable TV service is interrupted; please contact your cable operator.

Picture is cut off/with sidebar screen

- Is the image positioned correctly?
- Are screen mode adjustments such as picture size set correctly?

Customer Support

For technical support or product service, see the table below or contact your reseller.

Note: You will need the product serial number.

Country/ Region	Web Site	T=Telephone F=Fax
United States	www.viewsonic.com	800 688 6688
Canada	www.viewsonic.com	866 4634775
Latin America	www.viewsonic.com/la	909 444 8800

ENGLISH

Limited Warranty

VIEWSONIC® LCD TV

What the warranty covers:

ViewSonic® warrants its products to be free from defects in material and workmanship, under normal use, during the warranty period. If a product proves to be defective in material or workmanship during the warranty period, ViewSonic® will at its sole option repair or replace the product with a like product. Replacement product or parts may include remanufactured or refurbished parts or components.

How long the warranty is effective:

ViewSonic® LCD TV's are warranted for one (1) year for all parts excluding the light source and one (1) year for labor from the date of the first customer purchase.

Who the warranty protects:

This warranty is valid only for the first consumer purchaser.

What the warranty does not cover:

1. Any product on which the serial number has been defaced, modified or removed.
2. Damage, deterioration or malfunction resulting from:
 - a. Accident, misuse, neglect, fire, water, lightning, or other acts of nature, unauthorized product modification, or failure to follow instructions supplied with the product.
 - b. Repair or attempted repair by anyone not authorized by ViewSonic®.
 - c. Any damage of the product due to shipment.
 - d. Removal or installation of the product.
 - e. Causes external to the product, such as electric power fluctuations or failure.
 - f. Use of supplies or parts not meeting ViewSonic's specifications.
 - g. Normal wear and tear.
 - h. Any other cause which does not relate to a product defect.
3. Any product exhibiting a condition commonly known as "image burn-in" which results when a static image is displayed on the product for an extended period of time.
4. Removal, installation, and set-up service charges.

How to get service:

1. For information about receiving service under warranty, contact ViewSonic® Customer Support at 800-888-8583. You will need to provide your product's serial number.
2. To obtain warranted service, you will be required to provide (a) the original dated sales slip, (b) your name, (c) your address, (d) a description of the problem, and (e) the serial number of the product.
3. Take or ship the product freight prepaid in the original container to an authorized ViewSonic® service center or ViewSonic®.
4. For additional information or the name of the nearest ViewSonic® service center, contact ViewSonic®.

Limitation of implied warranties:

There are no warranties, express or implied, which extend beyond the description contained herein including the implied warranty of merchantability and fitness for a particular purpose.

Exclusion of damages:

ViewSonic's liability is limited to the cost of repair or replacement of the product. ViewSonic® shall not be liable for:

1. Damage to other property caused by any defects in the product, damages based upon inconvenience, loss of use of the product, loss of time, loss of profits, loss of business opportunity, loss of goodwill, interference with business relationships, or other commercial loss, even if advised of the possibility of such damages.
2. Any other damages, whether incidental, consequential or otherwise.
3. Any claim against the customer by any other party.

Effect of state law:

This warranty gives you specific legal rights, and you may also have other rights which vary from state to state. Some states do not allow limitations on implied warranties and/or do not allow the exclusion of incidental or consequential damages, so the above limitations and exclusions may not apply to you.

Sales outside the U.S.A. and Canada:

For warranty information and service on ViewSonic® products sold outside of the U.S.A. and Canada, contact ViewSonic® or your local ViewSonic® dealer.



ViewSonic®