

# SHARP®

## LC-46D43U

LIQUID CRYSTAL TELEVISION  
TÉLÉVISEUR ACL  
TELEVISOR CON PANTALLA DE  
CRISTAL LÍQUIDO  
TELEVISOR DE CRISTAL LIQUIDO

OPERATION MANUAL  
MODE D'EMPLOI  
MANUAL DE OPERACIÓN  
MANUAL DE OPERAÇÃO

# AQUOS



ENGLISH

FRANÇAIS

ESPAÑOL

PORTUGUÊS

**IMPORTANT** : Please read this operation manual before starting operating the equipment.  
**IMPORTANTE** : Lea este manual de operación antes de comenzar a operar el equipo.



# LC-46D43U

## LIQUID CRYSTAL TELEVISION

### ENGLISH

### OPERATION MANUAL

- The illustrations and on-screen displays in this operation manual are for explanation purposes and may vary slightly from the actual operations.
- Menu items that are not selectable are grayed out.





**IMPORTANT:**

To aid reporting in case of loss or theft, please record the TV's model and serial numbers in the space provided. The numbers are located at the rear of the TV.

Model No.:
Serial No.:

## IMPORTANT INFORMATION

**WARNING:** TO REDUCE THE RISK OF FIRE OR ELECTRIC SHOCK, DO NOT EXPOSE THIS PRODUCT TO RAIN OR MOISTURE.

 <div data-bbox="418 1556 688 1654" style="border: 1px solid black; padding: 5px; text-align: center;"> <p><b>CAUTION</b></p> <p>RISK OF ELECTRIC SHOCK DO NOT OPEN</p> </div> 	 <p>The lightning flash with arrow-head symbol, within an equilateral triangle, is intended to alert the user to the presence of uninsulated "dangerous voltage" within the product's enclosure that may be of sufficient magnitude to constitute a risk of electric shock to persons.</p>
<p>CAUTION: TO REDUCE THE RISK OF ELECTRIC SHOCK, DO NOT REMOVE COVER (OR BACK). NO USER-SERVICEABLE PARTS INSIDE. REFER SERVICING TO QUALIFIED SERVICE PERSONNEL.</p>	 <p>The exclamation point within a triangle is intended to alert the user to the presence of important operating and maintenance (servicing) instructions in the literature accompanying the product.</p>

# IMPORTANT INFORMATION

**CAUTION:** TO PREVENT ELECTRIC SHOCK, MATCH WIDE BLADE OF PLUG TO WIDE SLOT, FULLY INSERT.

**CAUTION:**

DO NOT PLACE THIS PRODUCT ON AN UNSTABLE CART, STAND, TRIPOD, BRACKET, OR TABLE. THE PRODUCT MAY FALL CAUSING SERIOUS PERSONAL INJURY AND SERIOUS DAMAGE TO THE PRODUCT. USE ONLY WITH A CART, STAND, TRIPOD, BRACKET, OR TABLE RECOMMENDED BY THE MANUFACTURER OR SOLD WITH THE PRODUCT. FOLLOW THE MANUFACTURER'S INSTRUCTIONS WHEN INSTALLING THE PRODUCT AND USE MOUNTING ACCESSORIES RECOMMENDED BY THE MANUFACTURER. A PRODUCT AND CART COMBINATION SHOULD BE MOVED WITH CARE. QUICK STOPS, EXCESSIVE FORCE, AND UNEVEN SURFACES MAY CAUSE THE PRODUCT AND CART COMBINATION TO OVERTURN.



**WARNING:** FCC Regulations state that any unauthorized changes or modifications to this equipment not expressly approved by the manufacturer could void the user's authority to operate this equipment.

**CAUTION:**

This product satisfies FCC regulations when shielded cables and connectors are used to connect the unit to other equipment. To prevent electromagnetic interference with electric appliances such as radios and televisions, use shielded cables and connectors for connections.

**DECLARATION OF CONFORMITY:**

SHARP LIQUID CRYSTAL TELEVISION, MODEL LC-46D43U

This device complies with Part 15 of the FCC Rules. Operation is subject to the following two conditions:

(1) This device may not cause harmful interference, and (2) this device must accept any interference received, including interference that may cause undesired operation.

RESPONSIBLE PARTY:

SHARP ELECTRONICS CORPORATION

Sharp Plaza, Mahwah, New Jersey 07430-2135

TEL: 1-800-BE-SHARP

For Business Customers: URL <http://www.sharppusa.com>

**INFORMATION:**

This equipment has been tested and found to comply with the limits for a Class B digital device, pursuant to Part 15 of the FCC Rules. These limits are designed to provide reasonable protection against harmful interference in a residential installation. This equipment generates, uses and can radiate radio frequency energy and, if not installed and used in accordance with the instructions, may cause harmful interference to radio communications. However, there is no guarantee that interference will not occur in a particular installation. If this equipment does cause harmful interference to radio or television reception, which can be determined by turning the equipment off and on, the user is encouraged to try to correct the interference by one or more of the following measures:

- Reorient or relocate the receiving antenna.
- Increase the separation between the equipment and receiver.
- Connect the equipment into an outlet on a circuit different from that to which the receiver is connected.
- Consult the dealer or an experienced radio/TV technician for help.

“Note to CATV system installer: This reminder is provided to call the CATV system installer's attention to Article 820-40 of the National Electrical Code that provides guidelines for proper grounding and, in particular, specifies that the cable ground shall be connected to the grounding system of the building, as close to the point of cable entry as practical.”

This product utilizes tin-lead solder, and fluorescent lamp containing a small amount of mercury. Disposal of these materials may be regulated due to environmental considerations. For disposal or recycling information, please contact your local authorities or the Electronic Industries Alliance: [www.eia.org](http://www.eia.org)

## Trademarks

• Manufactured under license from Dolby Laboratories. “Dolby” and the double-D symbol are trademarks of Dolby Laboratories.

• “HDMI, the HDMI logo and High-Definition Multimedia Interface are trademarks or registered trademarks of HDMI Licensing LLC.”

• Products that have earned the ENERGY STAR® are designed to protect the environment through superior energy efficiency.

# DEAR SHARP CUSTOMER

Thank you for your purchase of the Sharp Liquid Crystal Television. To ensure safety and many years of trouble-free operation of your product, please read the Important Safety Instructions carefully before using this product.

## IMPORTANT SAFETY INSTRUCTIONS

Electricity is used to perform many useful functions, but it can also cause personal injuries and property damage if improperly handled. This product has been engineered and manufactured with the highest priority on safety. However, improper use can result in electric shock and/or fire. In order to prevent potential danger, please observe the following instructions when installing, operating and cleaning the product. To ensure your safety and prolong the service life of your Liquid Crystal Television, please read the following precautions carefully before using the product.

- 1) Read these instructions.
- 2) Keep these instructions.
- 3) Heed all warnings.
- 4) Follow all instructions.
- 5) Do not use this apparatus near water.
- 6) Clean only with dry cloth.
- 7) Do not block any ventilation openings. Install in accordance with the manufacturer's instructions.
- 8) Do not install near any heat sources such as radiators, heat registers, stoves, or other apparatus (including amplifiers) that produce heat.
- 9) Do not defeat the safety purpose of the polarized or grounding-type plug. A polarized plug has two blades with one wider than the other. A grounding type plug has two blades and a third grounding prong. The wide blade or the third prong are provided for your safety. If the provided plug does not fit into your outlet, consult an electrician for replacement of the obsolete outlet.
- 10) Protect the power cord from being walked on or pinched particularly at plugs, convenience receptacles, and the point where they exit from the apparatus.
- 11) Only use attachments/accessories specified by the manufacturer.
- 12) Use only with the cart, stand, tripod, bracket, or table specified by the manufacturer, or sold with the apparatus. When a cart is used, use caution when moving the cart/apparatus combination to avoid injury from tip-over.
- 13) Unplug this apparatus during lightning storms or when unused for long periods of time.
- 14) Refer all servicing to qualified service personnel. Servicing is required when the apparatus has been damaged in any way, such as power-supply cord or plug is damaged, liquid has been spilled or objects have fallen into the apparatus, the apparatus has been exposed to rain or moisture, does not operate normally, or has been dropped.



### Additional Safety Information

- 15) Power Sources—This product should be operated only from the type of power source indicated on the marking label. If you are not sure of the type of power supply to your home, consult your product dealer or local power company. For products intended to operate from battery power, or other sources, refer to the operating instructions.
- 16) Overloading—Do not overload wall outlets, extension cords, or integral convenience receptacles as this can result in a risk of fire or electric shock.
- 17) Object and Liquid Entry—Never push objects of any kind into this product through openings as they may touch dangerous voltage points or short-out parts that could result in a fire or electric shock. Never spill liquid of any kind on the product.
- 18) Damage Requiring Service—Unplug this product from the wall outlet and refer servicing to qualified service personnel under the following conditions:
  - a) When the AC cord or plug is damaged,
  - b) If liquid has been spilled, or objects have fallen into the product,
  - c) If the product has been exposed to rain or water,
  - d) If the product does not operate normally by following the operating instructions.  
Adjust only those controls that are covered by the operating instructions as an improper adjustment of other controls may result in damage and will often require extensive work by a qualified technician to restore the product to its normal operation,
  - e) If the product has been dropped or damaged in any way, and
  - f) When the product exhibits a distinct change in performance - this indicates a need for service.
- 19) Replacement Parts—When replacement parts are required, be sure the service technician has used replacement parts specified by the manufacturer or have the same characteristics as the original part. Unauthorized substitutions may result in fire, electric shock, or other hazards.
- 20) Safety Check—Upon completion of any service or repairs to this product, ask the service technician to perform safety checks to determine that the product is in proper operating condition.
- 21) Wall or ceiling mounting—When mounting the product on a wall or ceiling, be sure to install the product according to the method recommended by the manufacturer.

# IMPORTANT SAFETY INSTRUCTIONS

- Water and Moisture — Do not use this product near water - for example, near a bath tub, wash bowl, kitchen sink, or laundry tub; in a wet basement; or near a swimming pool; and the like.



- Stand — Do not place the product on an unstable cart, stand, tripod or table. Placing the product on an unstable base can cause the product to fall, resulting in serious personal injuries as well as damage to the product. Use only a cart, stand, tripod, bracket or table recommended by the manufacturer or sold with the product. When mounting the product on a wall, be sure to follow the manufacturer's instructions. Use only the mounting hardware recommended by the manufacturer.

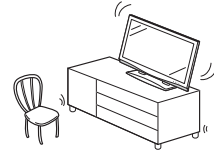

- Selecting the location — Select a place with no direct sunlight and good ventilation.



- Ventilation — The vents and other openings in the cabinet are designed for ventilation. Do not cover or block these vents and openings since insufficient ventilation can cause overheating and/or shorten the life of the product. Do not place the product on a bed, sofa, rug or other similar surface, since they can block ventilation openings. This product is not designed for built-in installation; do not place the product in an enclosed place such as a bookcase or rack, unless proper ventilation is provided or the manufacturer's instructions are followed.

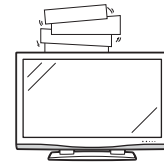

- The Liquid Crystal panel used in this product is made of glass. Therefore, it can break when the product is dropped or applied with impact. Be careful not to be injured by broken glass pieces in case the panel breaks.



- Heat — The product should be situated away from heat sources such as radiators, heat registers, stoves, or other products (including amplifiers) that produce heat.

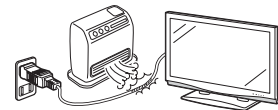

- The Liquid Crystal panel is a very high technology product with 3,147,264 thin film transistors, giving you fine picture details. Occasionally, a few non-active pixels may appear on the screen as a fixed point of blue, green or red. Please note that this does not affect the performance of your product.

## Precautions when transporting the TV

- Be sure to always carry the TV by two people holding it with two hands — one hand on each side of the TV.

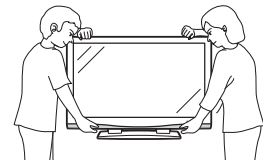

- Lightning — For added protection for this television equipment during a lightning storm, or when it is left unattended and unused for long periods of time, unplug it from the wall outlet and disconnect the antenna. This will prevent damage to the equipment due to lightning and power-line surges.



- Power Lines — An outside antenna system should not be located in the vicinity of overhead power lines or other electric light or power circuits, or where it can fall into such power lines or circuits. When installing an outside antenna system, extreme care should be taken to keep from touching such power lines or circuits as contact with them might be fatal.

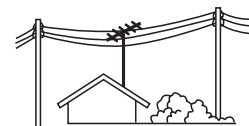

# IMPORTANT SAFETY INSTRUCTIONS

- Outdoor Antenna Grounding — If an outside antenna is connected to the television equipment, be sure the antenna system is grounded so as to provide some protection against voltage surges and built-up static charges. Article 810 of the National Electrical Code, ANSI/NFPA 70, provides information with regard to proper grounding of the mast and supporting structure, grounding of the lead-in wire to an antenna discharge unit, size of grounding conductors, location of antenna-discharge unit, connection to grounding electrodes, and requirements for the grounding electrode.

EXAMPLE OF ANTENNA GROUNDING AS PER NATIONAL ELECTRICAL CODE, ANSI/NFPA 70

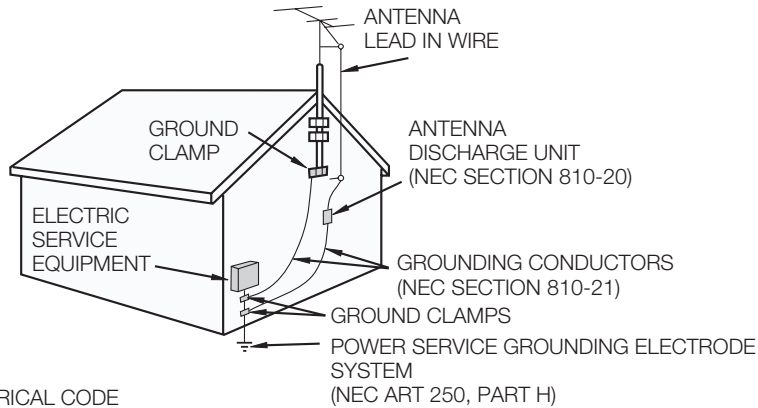

- To prevent fire, never place any type of candle or flames on the top or near the TV set.

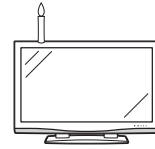

- To prevent fire or shock hazard, do not expose this product to dripping or splashing. No objects filled with liquids, such as vases, should be placed on the product.



- To prevent fire or shock hazard, do not place the AC cord under the TV set or other heavy items.

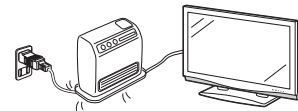

- Turn off the main power and unplug the AC cord from the wall outlet before handling.
- Use a soft cloth and gently wipe the surface of the display panel. Using a hard cloth may scratch the panel surface.
- Use a soft damp cloth to gently wipe the panel when it is really dirty. (It may scratch the panel surface when wiped strongly.)
- If the panel is dusty, use an anti-static brush, which is commercially available, to clean it.
- To protect the panel, do not use a dirty cloth, liquid cleaners or chemical cloth to clean it, such materials may damage the panel surface.
- To clean the outer cabinet, use the same method. Do not use liquid or aerosol cleaners.

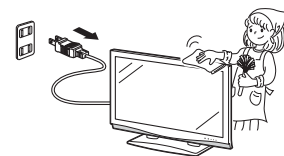

- Do not display a still picture for a long time, as this could cause an afterimage to remain.

# Supplied accessories

Make sure the following accessories are provided with the product.

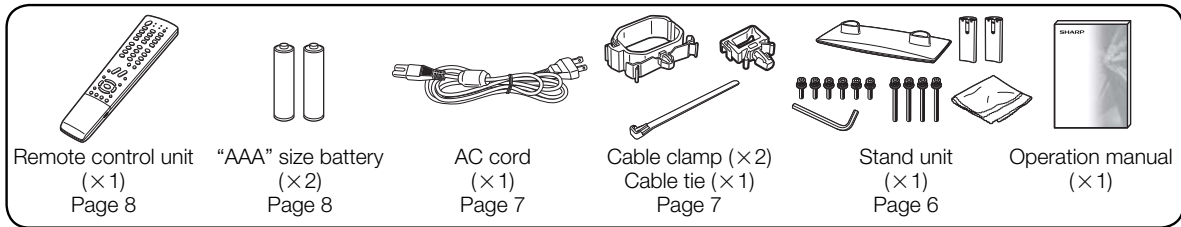

## NOTE

- Always use the AC cord supplied with the TV.
- AC cord enclosed in this product is for 110-125V. In using it on the 125-240V AC, please consult to the following.  
**SHARP ELECTRONICS CORPORATION**  
6100 Blue Lagoon Drive, Suite 230, Miami, Florida 33126, U.S.A.

# QUICK REFERENCE

## Attaching the stand

- Before attaching (or detaching) the stand, unplug the AC cord from the AC INPUT terminal.
- Before performing work spread cushioning over the base area to lay the TV on. This will prevent it from being damaged.

## CAUTION

- **Attach the stand in the correct direction.**
- **Be sure to follow the instructions. Incorrect installation of the stand may result in the TV falling over.**

- 1** Confirm that there are 10 screws (6 short screws and 4 long screws) supplied with the TV.



- 2** Attach the two supporting posts for the stand unit onto the base using the box for the stand unit as shown below.  
(Close-up of the upper side of the stand unit)

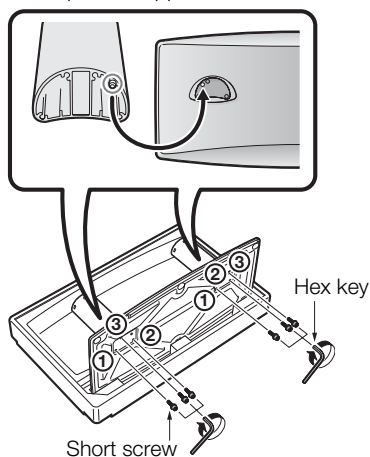

- 1 Insert each of the protrusions on the two supporting posts into the openings on the upper side of the base.
- 2 Insert and tighten the 6 short screws with the hex key (supplied with the product) in the order of ①, ② and ③.

- 3**
- ① Insert the stand into the openings on the bottom of the TV.
  - ② Insert and tighten the 4 long screws into the 4 holes on the rear of the TV.

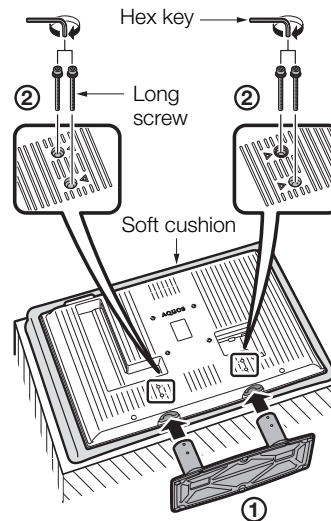

## NOTE

- To detach the stand, perform the steps in reverse order.



## QUICK REFERENCE

### STOP! To safely remove the AQUOS television from the box

- It's best to use 2 people to remove the AQUOS television for stability.
- Lift onto installation location as the diagram illustrates.

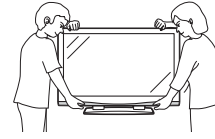

### Ventilation & Cleaning Tips

Keep your AQUOS television in a well ventilated area and make sure not to place it by a heat source or use near water. The AQUOS television is designed for AC use only and should be used with supplied AC cord.

Clean the screen by spraying a soft lint free cloth with water to lightly moisten. Gently wipe and avoid pressing on the screen. To clean the outer cabinet, use the same method. Do not use liquid or aerosol cleaners.

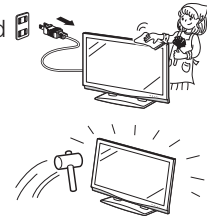

The screen is glass and can be scratched or broken when dropped or impacted.

### QUICK INSTALLATION TIPS

- 1 Attach your antenna to the back of the AQUOS television. (See page 12.)

- 2 Connect the AC plug for the AQUOS television into the AC outlet.

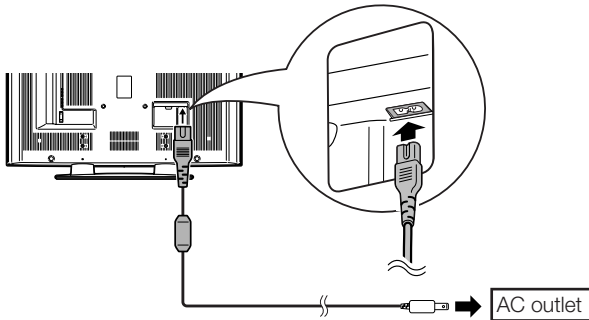

- Place the TV close to the AC outlet, and keep the power plug within reach.

#### NOTE

- **TO PREVENT RISK OF ELECTRIC SHOCK, DO NOT TOUCH UN-INSULATED PARTS OF ANY CABLES WITH THE AC CORD CONNECTED.**

- 3 Place the Ferrite core in the space indicated in the below figure and bundle the cords properly with cable clamps and a cable tie.

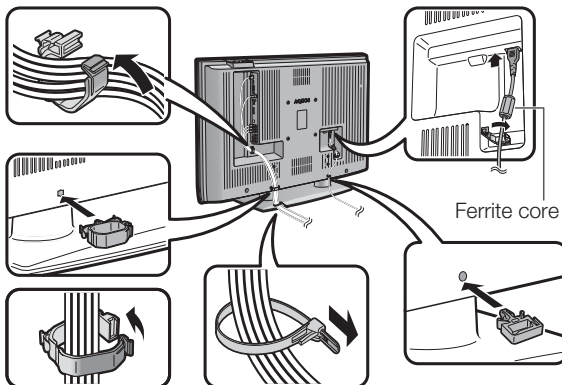

- 4 How to turn on the AQUOS television for the first time.

- A) Press **POWER** on the AQUOS television.

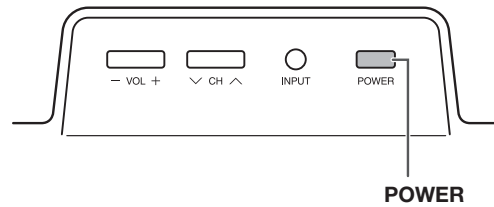

- B) The POWER indicator on the front of the AQUOS television lights GREEN.

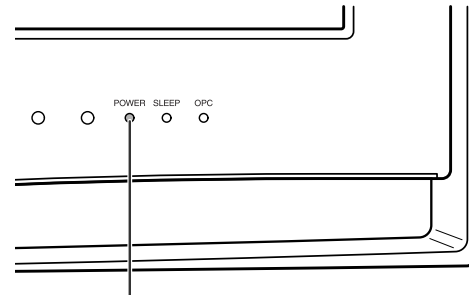

POWER indicator

#### NOTE

- Speakers cannot be detached from the TV.
- TV angle cannot be adjusted.

## QUICK REFERENCE

If the remote control fails to operate TV functions, replace the batteries in the remote control unit.

**1** Open the battery cover.

**2** Insert two "AAA" size batteries (supplied with the product).

**3** Close the battery cover.

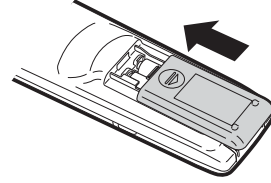
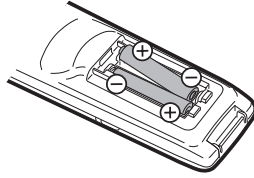
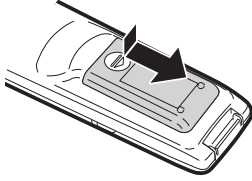

- Place the batteries with their terminals corresponding to the (+) and (-) indications in the battery compartment.

### CAUTION

Improper use of batteries can result in chemical leakage or explosion. Be sure to follow the instructions below.

- Do not mix batteries of different types. Different types of batteries have different characteristics.
- Do not mix old and new batteries. Mixing old and new batteries can shorten the life of new batteries or cause chemical leakage in old batteries.
- Remove batteries as soon as they are worn out. Chemicals that leak from batteries that come in contact with skin can cause a rash. If you find any chemical leakage, wipe thoroughly with a cloth.
- The batteries supplied with this product may have a shorter life expectancy due to storage conditions.
- If you will not be using the remote control unit for an extended period of time, remove batteries from it.

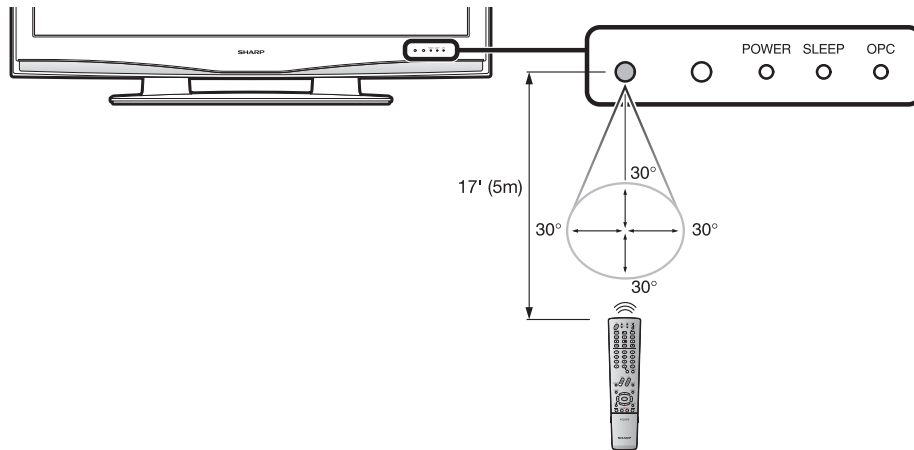

### IMPORTANT:

The POWER indicator on the AQUOS television should light GREEN indicating you have power to the AQUOS television.

If the POWER indicator on the AQUOS television still does not light up, press **TV POWER** on the remote control to turn the power on.

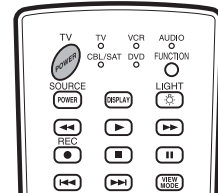

### IMPORTANT:

IF THE UNIT DOES NOT POWER ON - UNPLUG THE AQUOS TELEVISION FROM THE OUTLET AND REPEAT THE INSTALLATION STEPS.

IF YOU STILL ENCOUNTER NO POWER, PLEASE CONTACT US AT 1-800-BE-SHARP.

Please refer to the BASIC ADJUSTMENT SETTINGS SECTION for EZ Setup and basic channel setup functions and USING EXTERNAL EQUIPMENT SECTION for other device connections (DVD, VCR, AUDIO, etc.) in your AQUOS operation manual.

# Contents

<b>IMPORTANT INFORMATION</b> .....	<b>1</b>	<b>Using external equipment</b> .....	<b>29</b>
Trademarks .....	2	Displaying an external equipment image .....	29
<b>DEAR SHARP CUSTOMER</b> .....	<b>3</b>	Input Select .....	29
<b>IMPORTANT SAFETY INSTRUCTIONS</b> .....	<b>3</b>	Displaying an image from HDMI equipment.....	30
<b>Supplied accessories</b> .....	<b>6</b>	Input Skip .....	30
<b>QUICK REFERENCE</b> .....	<b>6</b>	<b>Useful adjustment settings</b> .....	<b>31</b>
Attaching the stand.....	6	Auto Sync. adjustment	
<b>Contents</b> .....	<b>9</b>	(for Analog PC input mode only) .....	31
<b>Part names</b> .....	<b>10</b>	Fine Sync. adjustment .....	31
TV (Front).....	10	Language setting .....	32
TV (Rear/Top) .....	10	Image position .....	32
Remote control unit .....	11	Reset.....	32
<b>Preparation</b> .....	<b>12</b>	Input Label.....	33
Using the remote control unit.....	12	Sleep Timer .....	33
Cautions regarding the remote control unit....	12	View Mode for 4:3 Programs .....	34
Antennas .....	12	View Mode for HD Programs .....	34
Connecting a Blu-ray disc player, HD-DVD player,		View Mode (for PC input mode) .....	35
DVD player or a Digital TV STB (Air or Cable) ...	13	Advanced Option settings.....	36
Connecting a VCR, game console		Audio Only .....	36
or camcorder.....	13	Digital Noise Reduction .....	36
Using Digital Audio Output.....	13	Output Select.....	36
Connecting HDMI equipment.....	14	Color System .....	36
Connecting a PC .....	14	Program Title Display .....	36
PC compatibility chart.....	14	AV MODE .....	37
<b>Watching TV</b> .....	<b>15</b>	Input Signal (for Analog PC input mode only) ....	37
Turning on the power.....	15	Closed Captions and Digital Closed Captions ...	38
Turning off the power.....	15	Caption Setup .....	39
Initial setup .....	16	Secret number setting for parental control .....	40
Simple button operations for		Parental control (setting V-CHIP level) .....	42
changing channels .....	17	How to temporarily release	
Simple button operations for		the V-CHIP BLOCK .....	45
changing volume/sound .....	18	Reactivating the temporarily released	
Setting MTS/SAP stereo mode .....	19	V-CHIP BLOCK .....	45
Setting Digital broadcasting audio mode.....	19	<b>Other viewing options</b> .....	<b>46</b>
<b>Basic adjustment settings</b> .....	<b>20</b>	Freezing images.....	46
Menu operation buttons.....	20	Presetting remote control function .....	46
On-Screen Display.....	20	<b>Appendix</b> .....	<b>50</b>
Menu items for TV/INPUT 1/2/3.....	21	Removing the stand.....	50
Menu items for HDMI/PC-IN .....	21	Setting the TV on the wall .....	50
EZ Setup .....	22	Troubleshooting.....	51
Channel Setup.....	22	Troubleshooting-Digital broadcasting.....	51
Antenna Setup - DIGITAL .....	23	Specifications .....	52
Favorite channel setting .....	24	Optional accessory .....	52
Picture adjustments .....	25	Information on the software license for this	
OPC setting .....	25	product .....	54
Advanced picture adjustments .....	26	<b>Calling for Service</b> .....	<b>55</b>
Color Temperature .....	26	<b>LIMITED WARRANTY</b> .....	<b>55</b>
Black.....	26		
I/P Setting .....	26	<b>Dimensional drawings</b>	
Film Mode (3:2 pull-down) .....	26	• The dimensional drawings for the LCD TV set are shown on	
3D-Y/C .....	26	the inside back cover.	
Monochrome .....	26		
Range of OPC.....	26		
Sound adjustment .....	27		
Surround .....	27		
Power Control .....	28		
Digital Setup .....	28		
Audio Setup.....	28		

# Part names

## TV (Front)

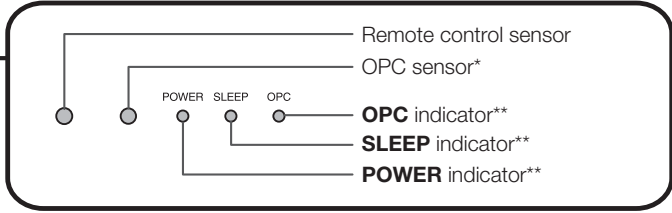
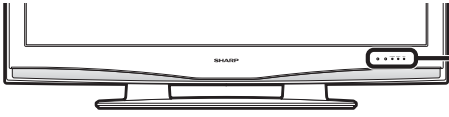

**NOTE**

\*OPC: Optical Picture Control (See page 25.)  
 \*\*See page 15 for TV status indicator.

## TV (Rear/Top)

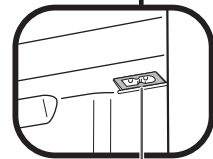
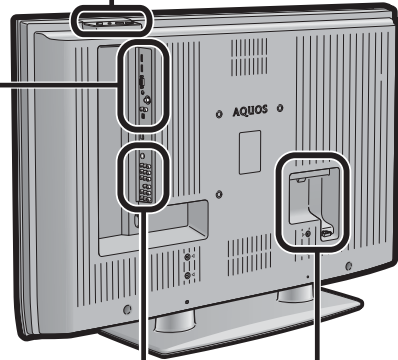
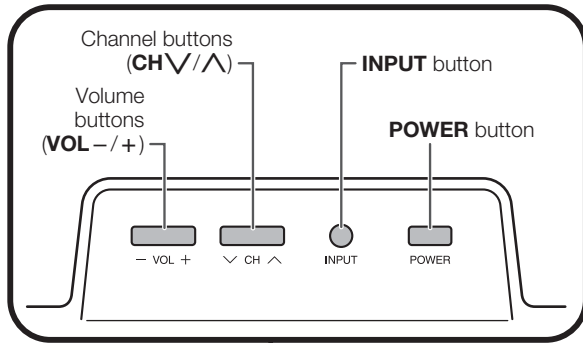
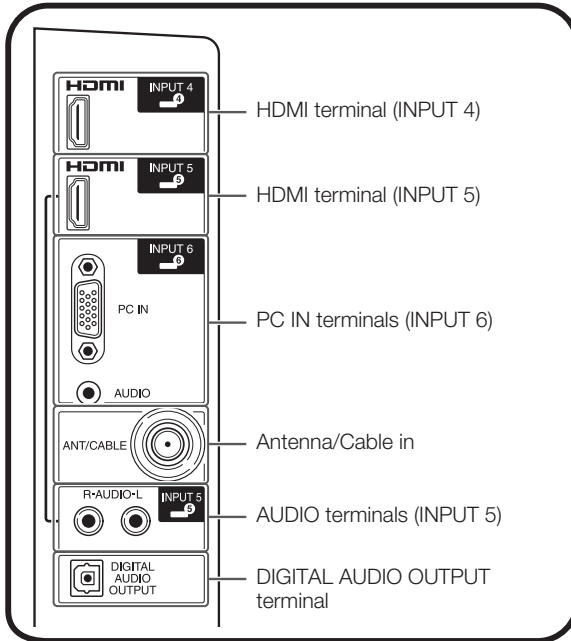

AC INPUT terminal

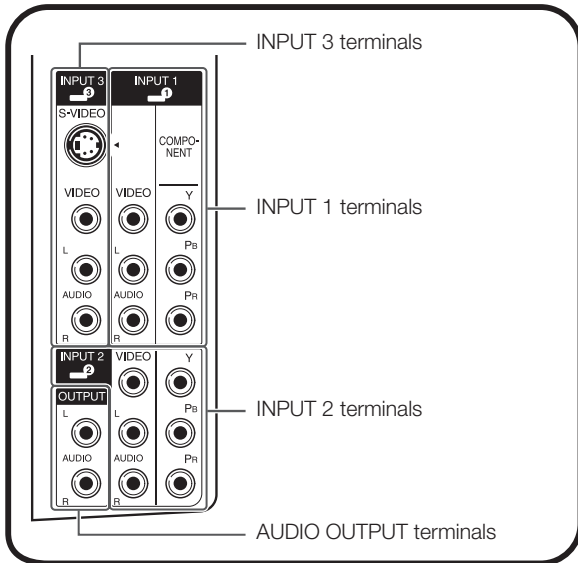

## Part names

### Remote control unit

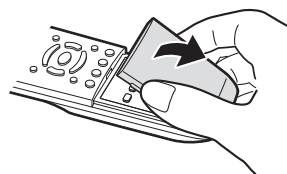
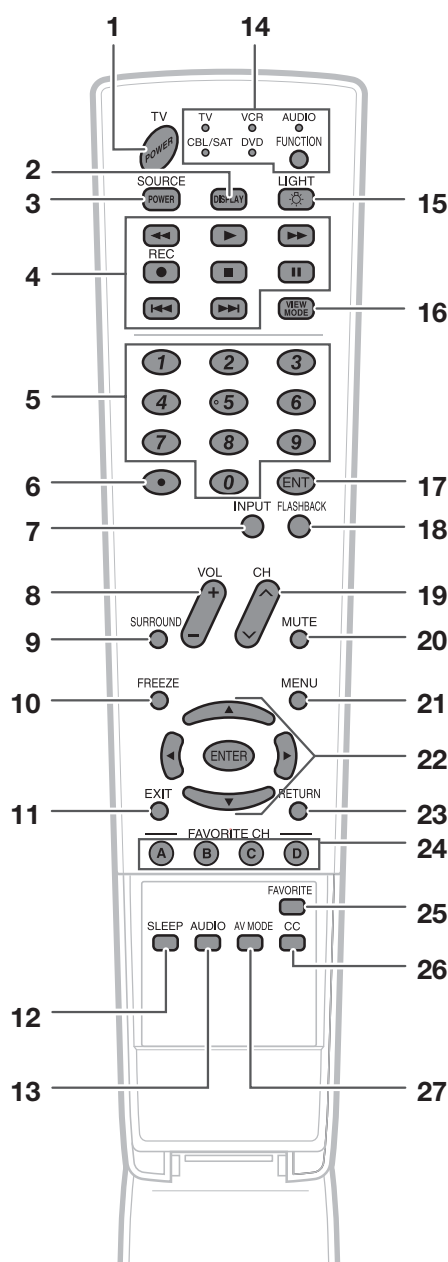

#### NOTE

- When using the remote control unit, point it at the TV.

- 1 TV POWER:** Switch the TV power on or enters standby. (See page 15.)
- 2 DISPLAY:** Display the channel information.
- 3 SOURCE POWER:** Turns the power of the external equipment on and off.
- 4 External equipment operational buttons:** Operate the external equipment.
- 5 0 – 9:** Set the channel. (See page 17.)
- 6 • (DOT):** (See pages 17 and 48.)
- 7 INPUT:** Select a TV input source. (TV, INPUT 1, INPUT 2, INPUT 3, INPUT 4, INPUT 5, INPUT 6) (See pages 29 and 30.)
- 8 VOL +/-:** Set the volume. (See page 18.)
- 9 SURROUND:** Select Surround settings. (See page 18.)
- 10 FREEZE:** Set the still image. Press again to return to normal screen. (See page 46.)
- 11 EXIT:** Turn off the menu screen.
- 12 SLEEP:** Set the sleep timer. (See page 33.)
- 13 AUDIO:** Selects the MTS/SAP or the audio mode during multi-channel audio broadcasts. (See page 19.)
- 14 FUNCTION:** Switches the remote control for TV, CBL/SAT, VCR, DVD and AUDIO operation. Indicator lights up for the current mode. (See pages 46 to 49 for details.)
  - \* To enter the code registration mode, you need to press **FUNCTION** and **DISPLAY** at the same time.
- 15 LIGHT** : When pressed all buttons on the remote control unit will light. The lighting will turn off if no operations are performed within about 5 seconds. This button is used for performing operations in low-light situations.
- 16 VIEW MODE:** Select the screen size. (See pages 34 and 35.)
- 17 ENT:** Jumps to a channel after selecting with the **0–9** buttons.
- 18 FLASHBACK:** Return to the previous channel or external input mode. (See page 17.)
- 19 CH /  $\wedge$  /  $\vee$ :** Select the channel. (See page 17.)
- 20 MUTE:** Mute the sound. (See page 18.)
- 21 MENU:** Display the menu screen.
- 22  $\blacktriangle$  /  $\blacktriangledown$  /  $\blacktriangleleft$  /  $\blacktriangleright$  / ENTER:** Select a desired item on the screen.
- 23 RETURN:** Return to the previous menu screen.
- 24 FAVORITE CH**
  - A, B, C, D:** Select 4 preset favorite channels in 4 different categories. (See page 24 for details.)
  - While watching, you can toggle the selected channels by pressing A, B, C and D.
- 25 FAVORITE:** Set the favorite channels. (See page 24.)
- 26 CC:** Display captions from a closed-caption source. (See page 38.)
- 27 AV MODE:** Select an audio or video setting. (When the input source is TV, INPUT 1, 2 or 3: STANDARD, MOVIE, GAME, USER, DYNAMIC (Fixed), DYNAMIC. When the input source is INPUT 4, 5 or 6: STANDARD, MOVIE, GAME, PC, USER, DYNAMIC (Fixed), DYNAMIC) (See page 37.)

# Preparation

## Using the remote control unit

Use the remote control unit by pointing it towards the remote control sensor on the TV. Objects between the remote control unit and the remote control sensor may prevent proper operation.

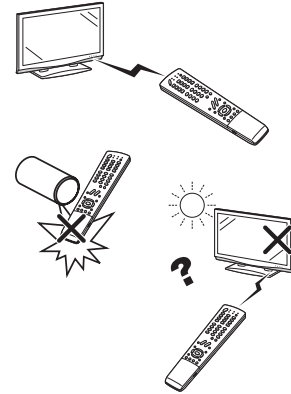

## Cautions regarding the remote control unit

- Do not expose the remote control unit to shock. In addition, do not expose the remote control unit to liquids, and do not place in an area with high humidity.
- Do not install or place the remote control unit under direct sunlight. The heat may cause deformation of the remote control unit.
- The remote control unit may not work properly if the remote control sensor on the TV is under direct sunlight or strong lighting. In such cases, change the angle of the lighting or the TV, or operate the remote control unit closer to the remote control sensor.

## Antennas

To enjoy a clearer picture, use an outdoor antenna. The following is a brief explanation of the types of connections that are used for a coaxial cable. If your outdoor antenna uses a 75-ohm coaxial cable with an F-type connector, plug it into the antenna terminal at the rear of the TV set.

1. A 75-ohm system is generally a round cable with F-type connector that can easily be attached to a terminal without tools (Commercially available).

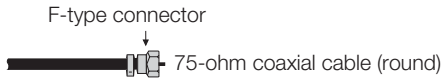

2. A 300-ohm system is a flat "twin-lead" cable that can be attached to a 75-ohm terminal through a 300/75-ohm adapter (Commercially available).

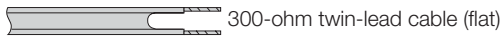

## NOTICE F-type connector should be finger-tightened only.

When connecting the RF cable to the TV set, do not tighten F-type connector with tools. If tools are used, it may cause damage to your TV set. (The breaking of internal circuit, etc.)

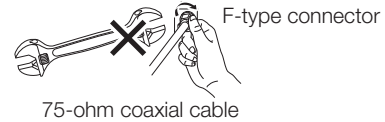

## Connecting Antenna Cable

- ① Cable without a CATV converter



- ② VHF/UHF antenna



- ③ Combination VHF/UHF antenna

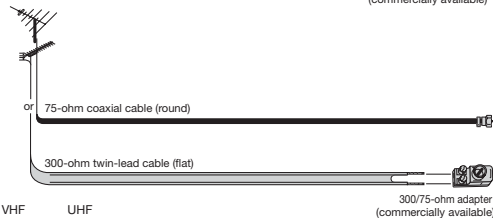

- ④ Separate VHF/UHF antenna

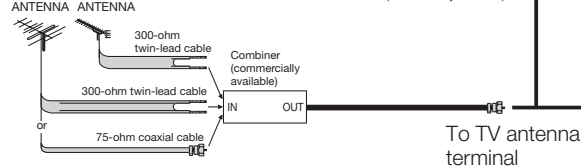

- Connect the antenna cable to the TV using one of the methods in the illustration as shown (①, ②, ③ or ④).

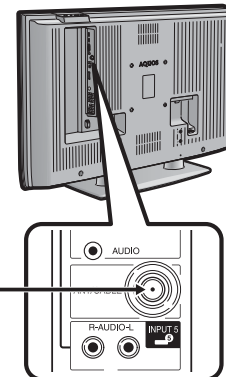

## Preparation

You can connect many types of external equipment to your TV like a Blu-ray disc player, HD-DVD player, DVD player, VCR, Digital TV tuner, HDMI equipment, game console or camcorder. To view external source images, select the input source from **INPUT** on the remote control unit or on the TV. (See pages 29 and 30.)

### CAUTION

- To protect equipment, always turn off the TV before connecting any external equipment.
- Please read the relevant operation manual (Blu-ray disc player, etc.) carefully before making connections.
- If your Blu-ray disc player offers a choice of output formats, please select 720p for use with this TV.

### Connecting a Blu-ray disc player, HD-DVD player, DVD player or a Digital TV STB (Air or Cable)

You can use the INPUT 1, INPUT 2 or INPUT 3 terminals when connecting to a Blu-ray disc player, HD-DVD player, DVD player, a Digital TV STB (Air or Cable) and other audiovisual equipment.

**When using composite cable (commercially available).**

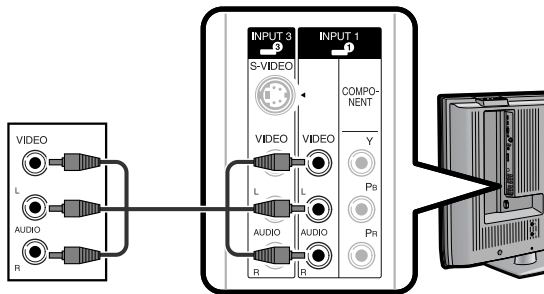

**Blu-ray disc player/HD-DVD player/ DVD player/ Digital TV STB**

**When using component cable. (INPUT 1 or 2)**

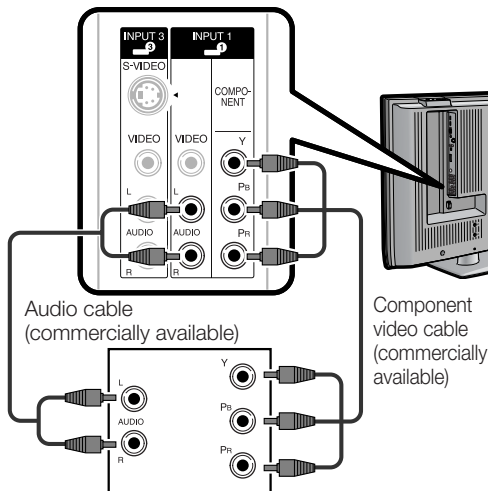

**Blu-ray disc player/HD-DVD player/ DVD player/Digital TV STB**

### Connecting a VCR, game console or camcorder

A VCR, game console, camcorder and other audiovisual equipment can be conveniently connected using the INPUT 1 to 3 terminals.

**When using S-VIDEO cable (commercially available).**

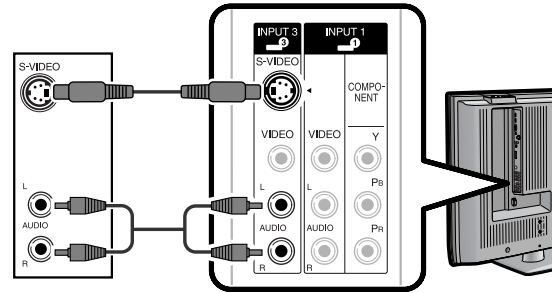

**VCR/Game console/ Camcorder**

**When using composite cable (commercially available).**

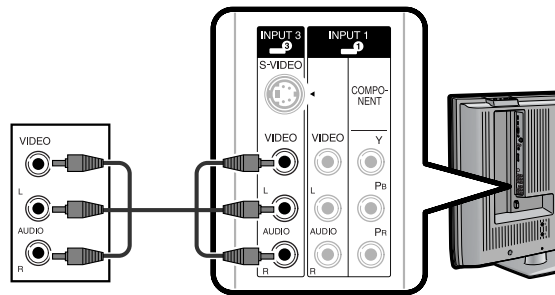

**VCR/Game console/ Camcorder**

### NOTE

- The S-VIDEO terminal takes priority over the video terminals. (INPUT 3 only)

### Using Digital Audio Output

It is possible to output audio through the DIGITAL AUDIO OUTPUT terminal. (See page 28 for details.) PCM audio outputs from the terminal.

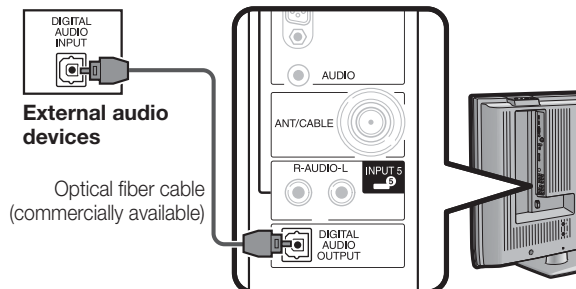

## Preparation

### Connecting HDMI equipment

You can use the INPUT 4 or INPUT 5 terminal when connecting HDMI equipment.

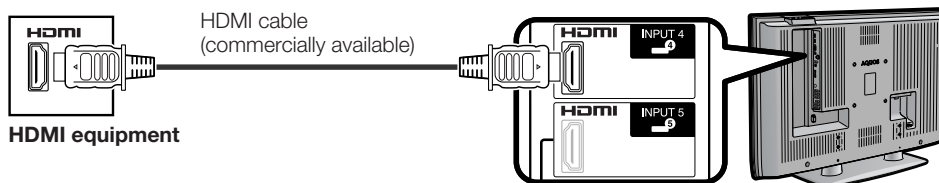

#### NOTE

- When using an HDMI-DVI conversion cable, input the audio signal to AUDIO terminal of INPUT 5.
- When receiving an incompatible signal, such as 1080p, the message below appears without the image on the screen.  
For an incompatible video signal: "An incompatible video signal has been received. Check the output device settings."  
For an incompatible audio signal: "An incompatible audio signal has been received. Check the output device settings."

### Connecting a PC

When connecting to a PC with an analog RGB terminal. (INPUT 6)

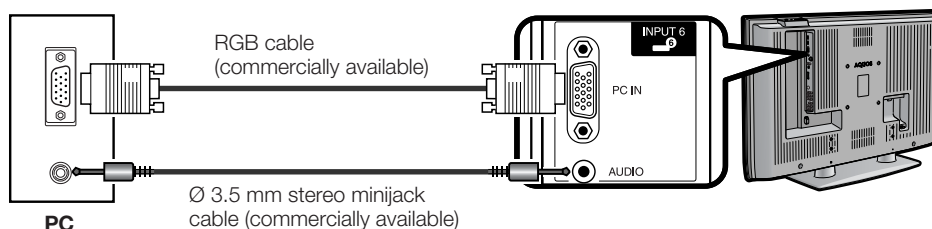

When connecting to a PC with an HDMI terminal. (INPUT 4 or 5)

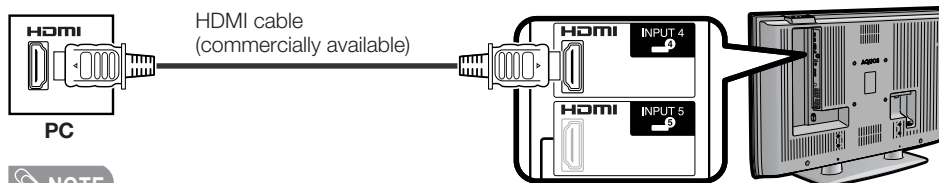

#### NOTE

- The HDMI terminals only support digital signal.

### PC compatibility chart

It is necessary to set the PC correctly to display XGA and WXGA signal. Refer to page 37 to set PC input signals.

PC	Resolution	Horizontal Frequency	Vertical Frequency	VESA Standard	
PC	VGA	720 x 400	31.5 kHz	70 Hz	—
		640 x 480	31.5 kHz	60 Hz	○
	37.9 kHz		72 Hz	○	
	37.5 kHz		75 Hz	○	
	SVGA	800 x 600	35.1 kHz	56 Hz	○
			37.9 kHz	60 Hz	○
			48.1 kHz	72 Hz	○
			46.9 kHz	75 Hz	○
	XGA	1024 x 768	48.4 kHz	60 Hz	○
			56.5 kHz	70 Hz	○
WXGA	1360 x 768	60.0 kHz	75 Hz	○	
		47.7 kHz	60 Hz	○	

DDC is a registered trademark of Video Electronics Standards Association.  
Power Management is a registered trademark of Sun Microsystems, Inc.  
VGA and XGA are registered trademarks of International Business Machines Co., Inc.



# Watching TV

Simple operations for watching a TV program

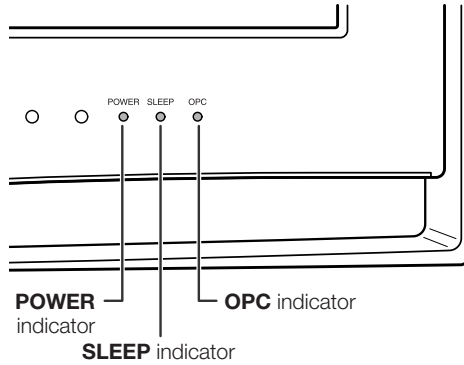
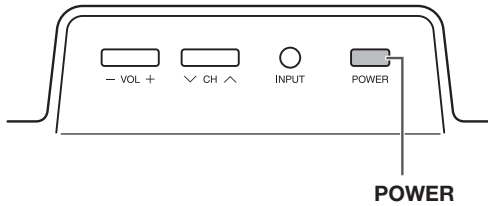

TV POWER (On/Standby)

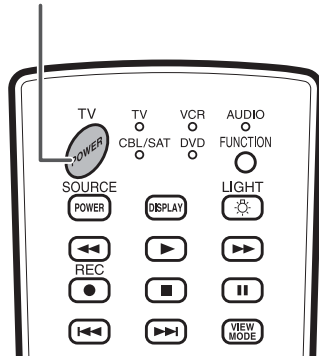

## Turning on the power

Press **POWER** on the TV, or **TV POWER** on the remote control unit.

- **POWER** indicator (Green): The TV is on. (After a few seconds, a window appears with sound.)

### NOTE

- The initial setup starts when the TV powers on for the first time. If the TV has been turned on before, the EZ Setup will not be invoked. See page 22 for performing EZ Setup from the Setup menu.

## Turning off the power

Press **POWER** on the TV, or **TV POWER** on the remote control unit.

- The TV enters standby and the image on the screen disappears.
- The **POWER** indicator on the TV turns off.

### NOTE

- If you are not going to use this TV for a long period of time, be sure to remove the AC cord from the AC outlet.
- Weak electric power is still consumed even when **POWER** is turned off.

### TV status indicator (POWER)

ON	Lighting (Green)
Standby	Lights off

### TV status indicator (OPC)

"Off" is selected in OPC setting	Lights off
"On" or "On: Display" is selected in OPC setting	Lighting (Green)

- See page 25 for details.

### TV status indicator (SLEEP)

"Off" is selected in SLEEP setting	Lights off
"30", "60", "90" or "120" is selected in SLEEP setting	Lighting (Red)

- See page 33 for details.

## Watching TV

### Initial setup

When you turn on the TV for the first time, it will automatically memorize the broadcasting channels where you live. Perform the following steps before you press **TV POWER** on the remote control unit.

1. Insert the batteries into the remote control unit. (See page 8.)
2. Connect the antenna cable to the TV. (See page 12.)
3. Plug in the AC cord to the AC outlet. (See page 7.)

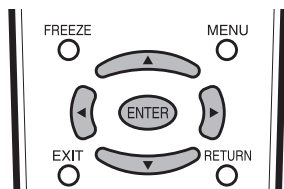

#### Language setting

Select from among 3 languages: English, French and Spanish.

- 1 Press ▲/▼ to select the desired language listed on the screen, and then press **ENTER**.

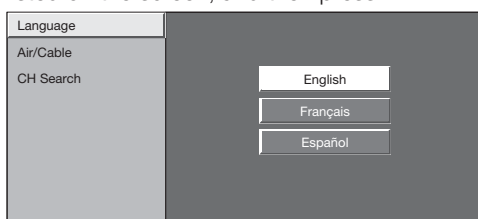

#### Antenna setting

Make sure what kind of connection is made with your TV when selecting "Air" or "Cable".

- 2 Press ◀/▶ to select "Air" or "Cable". Press **ENTER** to enter the setting.

##### Example

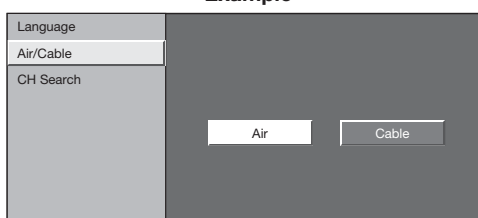

#### Channel search

Channel auto search makes the TV look for all channels viewable in the set area.

- 3 When "Air" is selected in Antenna setting:  
Press ◀/▶ to select "Start", and then press **ENTER**.

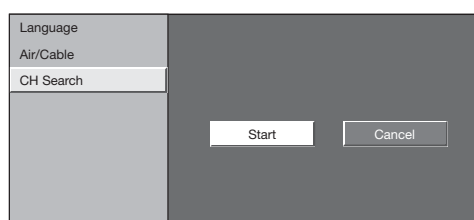

#### When "Cable" is selected in Antenna setting:

Press ▲/▼ to select "Analog & Digital Search Start" to search both analog and digital broadcasts or "Analog Search Start" to search only analog broadcasts, and then press **ENTER**.

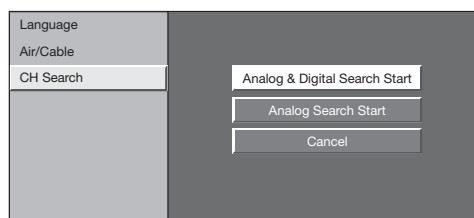

- The Channel search will start automatically.
- To exit the Channel search screen, select "Cancel", and then press **ENTER**.

##### Example

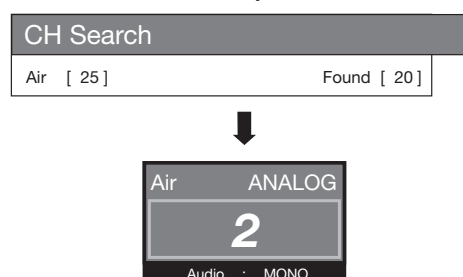

#### NOTE

- If no channel is found, confirm the type of connection made with your TV and try EZ Setup again. (See page 22.)

## Watching TV

### Simple button operations for changing channels

You can change channels in several ways.

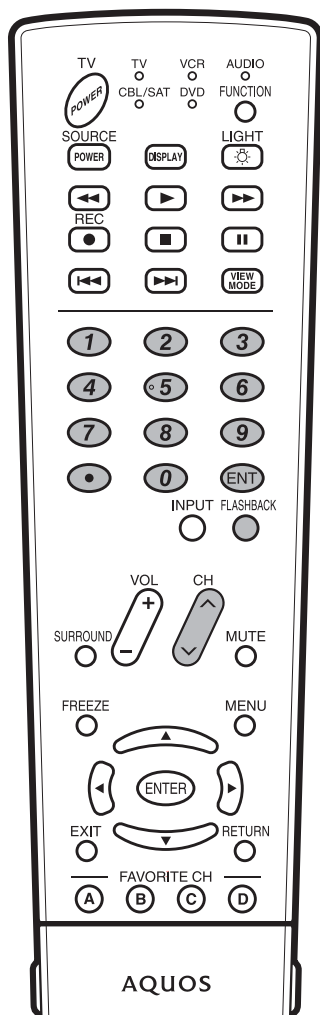
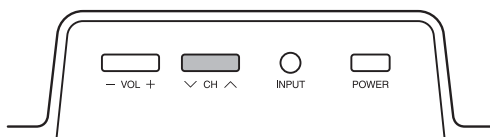

#### Method 1

Using **CH**  $\wedge/\vee$  on the remote control unit or on the TV.

#### Method 2

- 1 Press **FLASHBACK** to switch to the previously tuned channel.
- 2 Press **FLASHBACK** again to switch back to the currently tuned channel.

#### NOTE

- **FLASHBACK** will not work if no channel has been changed after the TV is turned on.

#### Method 3

Using remote control buttons **0-9**, • (DOT) to select channels for VHF/UHF/CATV/DIGITAL.

#### To select a 1 or 2-digit channel number (e. g., Channel 5):

Press **5** → **ENT**



#### NOTE

- When selecting a 1-digit channel number, it is not necessary to press **0** before the number.
- When you enter **0-9** only, channel selection will be made if there is no operation within a few seconds.

#### To select a 3-digit channel number (e. g., Channel 115):

Press **1** → **1** → **5**



#### To select a 4-digit channel number (e. g., Channel 22.1):

Press **2** → **2** → • (DOT) → **1** → **ENT**



#### NOTE

- When you enter **0-9** only, channel selection will be made if there is no operation within a few seconds.
- If you push "0" by itself, nothing will happen.
- Complete the above steps within a few seconds.
- When you enter **0-9** and • (DOT), channel selection will be made if there is no operation within a few seconds.

## Watching TV

### Simple button operations for changing volume/sound

#### ■ Changing the volume

You can change the volume on the TV or on the remote control unit.

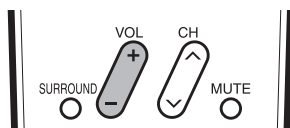
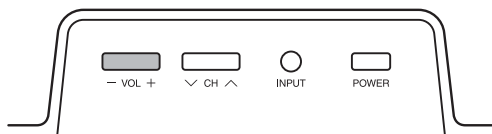

#### ■ Using VOL + / -

- To increase the volume, press **VOL +**.
- To decrease the volume, press **VOL -**.

#### Volume adjustment



#### NOTE

- **VOL - / +** on the TV operates the same as **VOL + / -** on the remote control unit.

#### Audio status

Output device	Output Select	
	Fixed	Variable
Speaker	Variable sound	Mute

\* When "Output Select" is set to "Variable", the indicator on the screen changes as shown below.



#### NOTE

- See page 36 for details on the Output Select function.

#### ■ Using MUTE on the remote control unit

Mutes the current sound output.

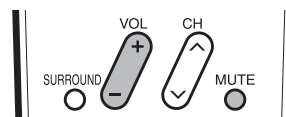

Press **MUTE**.

-  will be displayed on the screen for 30 minutes, and the sound is silenced.

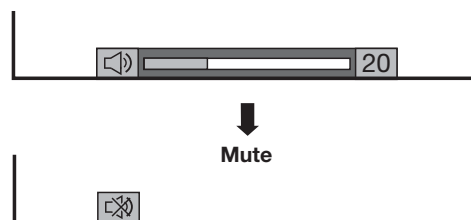

#### NOTE

- Within 30 minutes of pressing **MUTE**, mute can be canceled by using one of the methods below.
  - Mute will be canceled if you press **VOL + / -** or **MUTE**.
- Mute will be canceled after 30 minutes have passed. However, the TV will not suddenly output a loud sound as the volume level is set to 0 automatically.

#### ■ Using SURROUND on the remote control unit

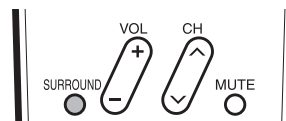

**SURROUND** produces Surround effect from the speakers. Each time you press **SURROUND**, the mode changes between On and Off.

#### Surround sound options

On: Makes it possible to enjoy natural, realistic surround sound.

Off: Outputs the normal sound.



#### NOTE

- You can have the same settings by choosing "Surround" on the menu items. (See page 27.)

## Watching TV

### Setting MTS/SAP stereo mode

The TV has a feature that allows reception of sound other than the main audio for the program. This feature is called Multi-channel Television Sound (MTS). The TV with MTS can receive mono sound, stereo sound and Secondary Audio Programs (SAP). The SAP feature allows a TV station to broadcast other information, which could be audio in another language or something completely different like weather information.

**You can enjoy Hi-Fi stereo sound or SAP broadcasts where available.**

- **Stereo broadcasts**

View programs like live sporting events, shows and concerts in dynamic stereo sound.

- **SAP broadcasts**

Receive TV broadcasts in either MAIN or SAP sound. MAIN sound: The normal program soundtrack (either in mono or stereo).

SAP sound: Listen to a second language, supplementary commentary or other information. (SAP is mono sound.)

**If stereo sound is difficult to hear.**

- Obtain a clearer sound by manually switching to fixed mono-sound mode.

**NOTE**

- MTS only operates while in TV mode.

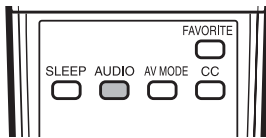

You can change MTS as shown below to match the television broadcast signal. Press **AUDIO** to toggle between audio modes.

**Examples: when receiving MTS and SAP**

**STEREO mode**

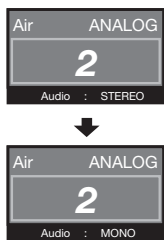

**MAIN + SAP mode**

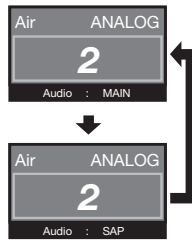

**STEREO + SAP mode**



**MONO mode**

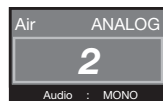

### Setting Digital broadcasting audio mode

The types of audio transmitted in a digital broadcast include SURROUND as well as MONO and STEREO. In addition, it is possible for multiple audio tracks to accompany a single video track.

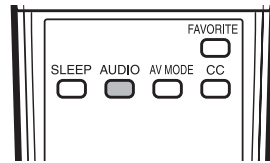

Press **AUDIO** to toggle between audio modes.

**Example: when receiving Digital broadcasting**

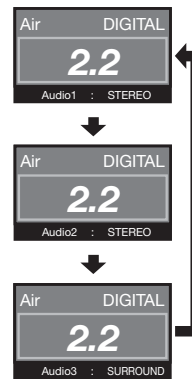

# Basic adjustment settings

## Menu operation buttons

Use the following buttons on the remote control to operate the menu.

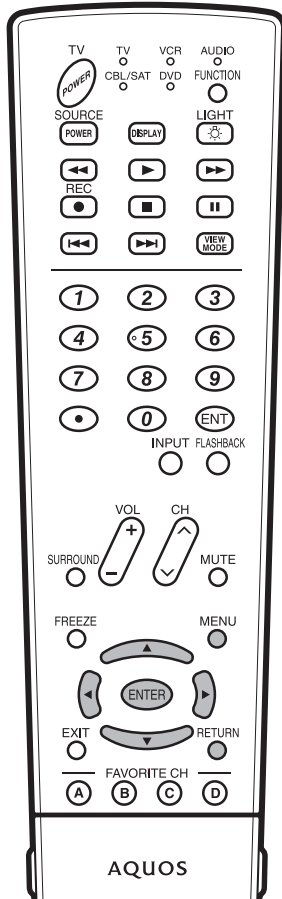

**MENU:** Press to open or close the menu screen.

**▲/▼/◀/▶:** Press to select a desired item on the screen or adjust a selected item.

**ENTER:** Press to go to the next step or complete the setting.

**RETURN:** Press to return to the previous step.

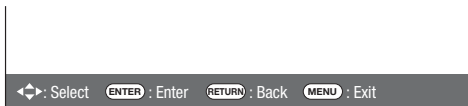

The bar above is an operational guide for the remote control. The bar will change in accordance with each menu setting screen.

## On-Screen Display

### Example

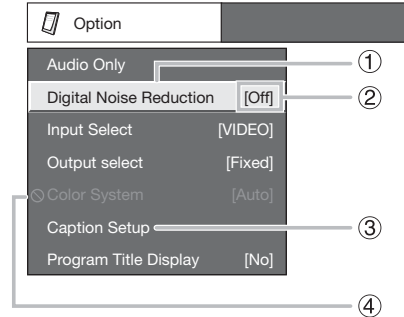

- ① Item displayed in yellow
  - This indicates the item currently selected.
  - Press **ENTER** to go to the adjustment screen for this item.
- ② Item in brackets
  - This indicates the current setting for the item.
- ③ Item displayed in white
  - This indicates an item can be selected.
- ④ Item displayed in gray
  - This indicates that the item cannot be selected. There are various reasons why items cannot be selected, but the main reasons are as follows:
    - Nothing is connected to the selected input terminal.
    - The function is not compatible with the current input signal.

### NOTE

- Menu options differ in the selected input modes, but the operating procedures are the same.
- The screens in the operation manual are for explanation purposes (some are enlarged, others cropped) and may vary slightly from the actual screens.

## Basic adjustment settings

### Menu items for TV/INPUT 1/2/3

#### Picture

OPC.....	Page 25
Backlight .....	Page 25
Contrast .....	Page 25
Brightness .....	Page 25
Color .....	Page 25
Tint .....	Page 25
Sharpness .....	Page 25
Advanced	
Color Temp. ....	Page 26
Black .....	Page 26
I/P Setting .....	Page 26
Film Mode .....	Page 26
3D-Y/C .....	Page 26
Monochrome .....	Page 26
Range of OPC .....	Page 26

#### Audio

Treble .....	Page 27
Bass .....	Page 27
Balance.....	Page 27
Surround.....	Page 27

#### Power Control

No Signal Off.....	Page 28
No Operation Off .....	Page 28

#### Setup

EZ Setup .....	Page 22
CH Setup .....	Page 22
Antenna Setup-DIGITAL.....	Page 23
Input Skip .....	Page 30
Input Label .....	Page 33
Parental CTRL.....	Pages 40-45
Position.....	Page 32
Language.....	Page 32
Reset.....	Page 32

#### Option

Audio Only .....	Page 36
Digital Noise Reduction .....	Page 36
Input Select .....	Page 29
Output Select .....	Page 36
Color System .....	Page 36
Caption Setup .....	Page 39
Program Title Display .....	Page 36
Favorite CH .....	Page 24

#### Digital Setup

Audio Setup.....	Page 28
------------------	---------

### Menu items for HDMI/PC-IN

#### Picture

OPC.....	Page 25
Backlight .....	Page 25
Contrast .....	Page 25
Brightness .....	Page 25
Color .....	Page 25
Tint .....	Page 25
Sharpness .....	Page 25
Advanced	
Color Temp. ....	Page 26
Black .....	Page 26
I/P Setting .....	Page 26
Film Mode .....	Page 26
Monochrome .....	Page 26
Range of OPC .....	Page 26

#### Audio

Treble .....	Page 27
Bass .....	Page 27
Balance.....	Page 27
Surround.....	Page 27

#### Power Control

No Signal Off.....	Page 28
No Operation Off .....	Page 28

#### Setup

Input Skip .....	Page 30
Input Signal .....	Page 37
Auto Sync .....	Page 31
Input Label .....	Page 33
Fine Sync.....	Page 31
Position.....	Page 32
Language.....	Page 32
Reset.....	Page 32

#### Option

Audio Only .....	Page 36
Digital Noise Reduction .....	Page 36
HDMI Setup .....	Page 30
Output Select .....	Page 36

#### NOTE

- Some menu items may not be displayed depending on the selected input source.

## Basic adjustment settings

### EZ Setup

You can run EZ Setup again, even after setting up the preset channels.

#### Language setting

Select from among 3 languages: English, French and Spanish.

**1** Press **MENU** to display the MENU screen, and then press **◀/▶** to select "Setup".

**2** Press **▲/▼** to select "EZ Setup", and then press **ENTER**.

- If you already set the Secret No., go to step 3. If not, skip to step 4.

**3** Input the 4-digit secret number by using **0-9**.

**4** Press **▲/▼** to select the desired language listed on the screen, and then press **ENTER**.

#### Antenna setting

Make sure what kind of connection is made with your TV when selecting "Air" or "Cable".

**5** Press **◀/▶** to select "Air" or "Cable". Press **ENTER** to enter the setting.

#### Channel search

Channel auto search makes the TV look for all channels viewable in the set area.

**6** **When "Air" is selected in Antenna setting:** Press **◀/▶** to select "Start", and then press **ENTER**.

**When "Cable" is selected in Antenna setting:**

Press **▲/▼** to select "Analog & Digital Search Start" to search both analog and digital broadcasts or "Analog Search Start" to search only analog broadcasts, and then press **ENTER**.

- The Channel search will start automatically.
- To exit the Channel search screen, select "Cancel", and then press **ENTER**.

**7** Press **MENU** to exit.

#### NOTE

- If no channel is found, confirm the type of connection made with your TV and try EZ Setup again.
- If you select "Analog Search Start" and initiate the channel search, the CH Memory for Cable Digital will be deleted.

### Channel Setup

If initial setup does not memorize all the channels in your region, follow the instructions below to manually memorize the channels.

#### Antenna setting

**1** Press **MENU** to display the MENU screen, and then press **◀/▶** to select "Setup".

**2** Press **▲/▼** to select "CH Setup", and then press **ENTER**.

- If you already set the Secret No., input the 4-digit secret number here. See page 40 for setting a secret number.

**3** Press **▲/▼** to select "Air/Cable", and then press **ENTER**.

**4** Press **◀/▶** to select "Air" or "Cable". Press **ENTER** to enter the setting.

**5** Press **MENU** to exit.

#### Channel search

Channel auto search makes the TV look for all channels viewable in the set area.

**1** Repeat steps 1 and 2 in Antenna setting in **Channel Setup**.

**2** Press **▲/▼** to select "CH Search", and then press **ENTER**.

**3** **When "Air" is selected in Antenna setting:** Press **◀/▶** to select "Start", and then press **ENTER**.

**When "Cable" is selected in Antenna setting:**

Press **▲/▼** to select "Analog & Digital Search Start" to search both analog and digital broadcasts or "Analog Search Start" to search only analog broadcasts, and then press **ENTER**.

- The Channel search will start automatically.
- To exit the Channel search screen, select "Cancel", and then press **ENTER**.

**4** Press **MENU** to exit.

#### NOTE

- If no channel is found, confirm the type of connection made with your TV and try channel search again.
- If you select "Analog Search Start" and initiate the channel search, the CH Memory for Cable Digital will be deleted.



## Basic adjustment settings

### Channel memory setting

**1** Press **MENU** to display the MENU screen, and then press **◀/▶** to select "Setup".

**2** Press **▲/▼** to select "CH Setup", and then press **ENTER**.

- If you already set the Secret No., input the 4-digit secret number here. See page 40 for setting a secret number.

**3** Press **▲/▼** to select "CH Memory", and then press **ENTER**.

**4** Press **▲/▼** to select ANALOG (Air), ANALOG (Cable), DIGITAL (Air) or DIGITAL (Cable), and then press **ENTER**.

#### **5** When viewing ANALOG broadcasts:

- ① Press **◀/▶** to select the channel to skip, and then press **▼** to move down.
- ② Press **◀/▶** to select "On", and then press **ENTER**.

#### When viewing DIGITAL broadcasts:

- ① Press **▲/▼** to select the channel to skip, and then press **◀/▶** to select "On".

- On: Skips channels. (Channel selection disabled using **CH ▲/▼**.)
- Off: Does not skip channels. (Channel selection enabled using **CH ▲/▼**.)

**6** Press **MENU** to exit.

#### **NOTE**

- Make sure what kind of connection is made with your TV.

## Antenna Setup - DIGITAL

In order to receive digital air broadcasts, you need a digital broadcast antenna. You can confirm the antenna configuration through the "Antenna Setup - DIGITAL" screen.

If necessary, adjust the direction of the antenna to obtain the maximum signal strength.

### Signal Strength

**1** Press **MENU** to display the MENU screen, and then press **◀/▶** to select "Setup".

**2** Press **▲/▼** to select "Antenna Setup - DIGITAL", and then press **ENTER**.

**3** Press **▲/▼** to select "Signal Strength".

- The signal strength of DIGITAL channel is displayed. The signal information is based on the current channel.

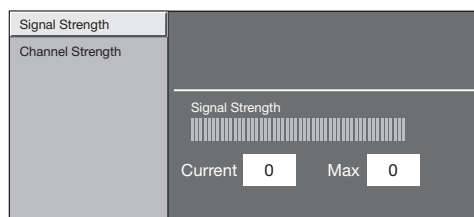

**4** Press **MENU** to exit.

### Channel Strength

The channel signal strength can also be checked separately.

**1** Repeat steps 1 and 2 in Signal Strength in **Antenna Setup - DIGITAL**.

**2** Press **▲/▼** to select "Channel Strength", and then press **ENTER**.

**3** Input the 2-digit channel number to check the signal strength of the selected channel.

- Make sure the signal is strong enough for each channel.

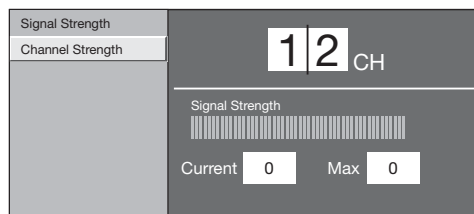

**4** Press **MENU** to exit.

#### **NOTE**

- This function is available for DIGITAL (Air) only.

## Basic adjustment settings

### Favorite channel setting

This function allows you to program 4 favorite channels, in 4 different categories. By setting the favorite channels in advance, you can select your favorite channels easily.

#### Using FAVORITE CH on the remote control unit

- 1 Select the channel you want to register as a favorite channel.
- 2 Press **FAVORITE**.
- 3 Press **▲/▼** to select "Register", and then press **ENTER**.
- 4 Press **▲/▼/◀/▶** to select the position in the category, and then press **ENTER** to register.

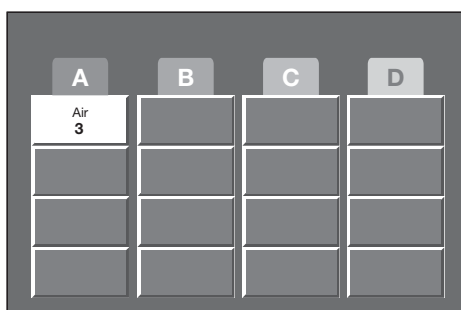

#### Deleting a favorite channel

- 1 Press **FAVORITE** and the favorite channel screen displays.
- 2 Press **▲/▼** to select "1 Data Clear", and then press **ENTER**.
  - To delete all the favorite channels, select "All Data Clear", and then skip to step 4.
- 3 Press **▲/▼/◀/▶** to select the channel you want to delete, and then press **ENTER**.

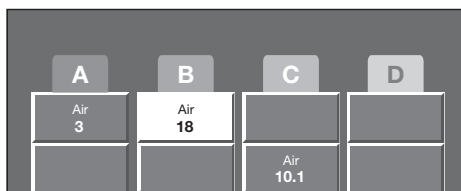

- 4 Press **◀/▶** to select "Yes", and then press **ENTER**.



#### Using Favorite CH on the menu screen

You can also set your favorite channels in "Option" on the MENU screen.

- 1 Select the channel you want to register as a favorite channel.
- 2 Press **MENU** to display the MENU screen, and then press **◀/▶** to select "Option".
- 3 Press **▲/▼** to select "Favorite CH", and then press **ENTER**.
- 4 Press **▲/▼** to select "Register", and then press **ENTER**.
- 5 Press **▲/▼/◀/▶** to select the position in the category, and then press **ENTER** to register.
- 6 Press **MENU** to exit.

#### Deleting a favorite channel

- 1 Repeat steps 2 and 3 in **Using Favorite CH on the menu screen**.
- 2 Press **▲/▼** to select "1 Data Clear", and then press **ENTER**.
  - To delete all the favorite channels, select "All Data Clear", and then skip to step 4.
- 3 Press **▲/▼/◀/▶** to select the channel you want to delete, and then press **ENTER**.
- 4 Press **◀/▶** to select "Yes", and then press **ENTER**.
- 5 Press **MENU** to exit.

## Basic adjustment settings

### Picture adjustments

Adjusts the picture to your preference with the following picture settings.

- 1 Press **MENU** to display the MENU screen, and then press ◀/▶ to select "Picture".
- 2 Press ▲/▼ to select a specific adjustment item.
- 3 Press ◀/▶ to adjust the item to the desired level.
- 4 Press **MENU** to exit.

#### NOTE

- For resetting all Picture adjustment items to the factory preset values, press ▲/▼ to select "Reset", press **ENTER**, press ◀/▶ to select "Yes", and then press **ENTER**.



Selected item	◀button	▶button
<b>Backlight</b>	The screen dims	The screen brightens
<b>Contrast</b>	For less contrast	For more contrast
<b>Brightness</b>	For less brightness	For more brightness
<b>Color</b>	For less color intensity	For more color intensity
<b>Tint</b>	Skin tones become reddish	Skin tones become greenish
<b>Sharpness</b>	For less sharpness	For more sharpness

#### NOTE

- Select "Advanced" and then press **ENTER** to set "Color Temp.", "Black", "I/P Setting", "Film Mode", "3D-Y/C", "Monochrome" or "Range of OPC". See page 26.

### OPC setting

Automatically adjusts the brightness of the screen.

- 1 Press **MENU** to display the MENU screen, and then press ◀/▶ to select "Picture".
- 2 Press ▲/▼ to select "OPC".
- 3 Press ◀/▶ to select "On" or "On: Display".

Selected item	Description
<b>Off</b>	The brightness is fixed at the value set in "Backlight".
<b>On</b>	Automatically adjusts
<b>On: Display</b>	Displays the OPC effect on the screen while adjusting the brightness of the screen.

- 4 Press **MENU** to exit.

#### NOTE

- When set to "On", the OPC senses the surrounding light and automatically adjusts the backlight brightness. Make sure nothing obstructs the OPC sensor, which could affect its ability to sense surrounding light.
- When set to "On: Display", OPC effect displays on the screen while the OPC adjusts the screen brightness.

## Basic adjustment settings

### Advanced picture adjustments

This TV provides various advanced functions for optimizing the picture quality.

- 1 Press **MENU** to display the MENU screen, and then press **◀/▶** to select "Picture".
- 2 Press **▲/▼** to select "Advanced", and then press **ENTER**.
- 3 Press **▲/▼** to select a specific adjustment item, and then press **ENTER**.
  - You can select "Color Temp.", "Black", "I/P Setting", "Film Mode", "3D-Y/C", "Monochrome", or "Range of OPC".
- 4 Press **▲/▼** (or **◀/▶**) to select the desired parameter.
  - See the table for the selectable parameters.
- 5 Press **MENU** to exit.

### Color Temperature

For a better white balance, use color temperature correction.

Selected item	Description
High Mid-High Middle Mid-Low Low	White with Bluish tone  ↑ ↓  White with Reddish tone

### Black

Changes the viewing depth by automatically adjusting the dark portion of an image for easier viewing.

Selected item	Description
On	For high detail in black portions
Off	No adjustment

### I/P Setting

Converts input signals depending on the type of images.

Selected item	Description
Fast	Suitable for fast-moving images
Slow	Suitable for smooth images with low amounts of flickers

#### NOTE

- "I/P Setting" is not selectable when channel display shows an input resolution of 480P, 720P, or 1080i.

### Film Mode (3:2 pull-down)

Automatically detects a film-based source (originally encoded at 24 frames/second), analyzes it then recreates each still film frame for high-definition picture quality.

Selected item	Description
On	Detects, analyzes, converts film source
Off	Normal viewing mode

#### NOTE

- "Film Mode" does not function when you set:
  - the "AV Mode" to "Game" or
  - the "I/P Setting" to "Fast".

### 3D-Y/C

Provides high quality images with minimal dot crawl and cross color noise.

Selected item	Description
Slow	For still images
Standard	Normal adjustment
Fast	For moving images
Off (2D)	For Game Mode

#### NOTE

- 3D-Y/C is available for input signal from Composite Video and analog broadcasts (air and cable).

### Monochrome

For viewing a video in monochrome.

Selected item	Description
On	For viewing in monochrome
Off	Normal color

### Range of OPC

The brightness level range of the OPC sensor's automatic adjustments can be set according to your preferences. The adjustment range of the OPC sensor can be set to a maximum of +16 and a minimum of -16.

Selected item	Description
Max.	-15 through +16
Min.	-16 through +15

#### NOTE

- The range of OPC settings are active only when the OPC is set to On.
- The maximum setting cannot be set to a smaller number than the minimum setting.
- The minimum setting cannot be set to a bigger number than the maximum setting.
- Depending on the brightness of the surrounding light, the OPC sensor might not operate if the adjustment range is small.

## Basic adjustment settings

### Sound adjustment

You can adjust the sound quality to your preference with the following settings.

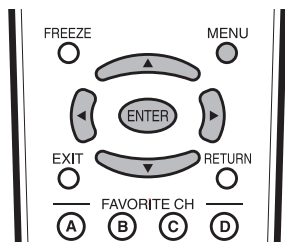

- 1 Press **MENU** to display the MENU screen, and then press **◀▶** to select "Audio".

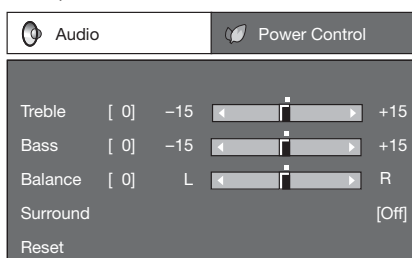

- 2 Press **▲▼** to select a specific adjustment item.

- 3 Press **◀▶** to adjust the item to the desired level.

Selected item	◀ button	▶ button
<b>Treble</b>	For weaker treble	For stronger treble
<b>Bass</b>	For weaker bass	For stronger bass
<b>Balance</b>	Decrease audio from the right speaker	Decrease audio from the left speaker

- 4 Press **MENU** to exit.

#### NOTE

- Audio menu is grayed out when Output Select is set to "Variable".
- For resetting all Audio adjustment items to the factory preset values, press **▲▼** to select "Reset", press **ENTER**, press **◀▶** to select "Yes", and then press **ENTER**.

### Surround

Surround function allows you to enjoy realistic "live" sound.

- 1 Press **MENU** to display the MENU screen, and then press **◀▶** to select "Audio".

- 2 Press **▲▼** to select "Surround", and then press **ENTER**.

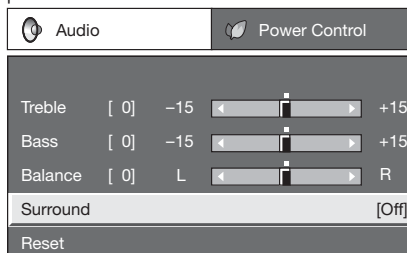

- 3 Press **◀▶** to select "On", and then press **ENTER**.

- 4 Press **MENU** to exit.

#### NOTE

- You can choose Surround by pressing **SURROUND** on the remote control unit. (See page 18.)
- Audio menu is grayed out when Output Select is set to "Variable".
- For some discs, setup may be required on your DVD player. In this case, please refer to the operation manual of your DVD player.

## Basic adjustment settings

### Power Control

Power control setting allows you to save energy.

#### No signal off

When set to “Enable”, the power will automatically shut down if there is no signal for 15 minutes.

**1** Press **MENU** to display the MENU screen, and then press **◀/▶** to select “Power Control”.

**2** Press **▲/▼** to select “No Signal Off”, and then press **ENTER**.

**3** Press **◀/▶** to select “Enable”, and then press **ENTER**.

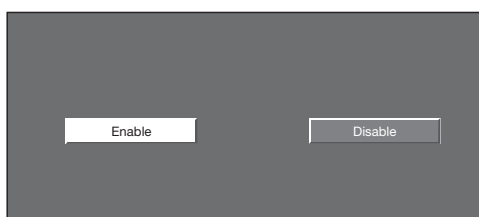

- Five minutes before the power shuts down, the remaining time displays every minute.

**4** Press **MENU** to exit.

#### NOTE

- “Disable” is the factory preset value.
- When a TV program finishes, this function may not operate.

#### No operation off

When set to “Enable”, the power will automatically shut down if there is no operation for 3 hours.

**1** Press **MENU** to display the MENU screen, and then press **◀/▶** to select “Power Control”.

**2** Press **▲/▼** to select “No Operation Off”, and then press **ENTER**.

**3** Press **◀/▶** to select “Enable”, and then press **ENTER**.

- Five minutes before the power shuts down, the remaining time displays every minute.

**4** Press **MENU** to exit.

#### NOTE

- “Disable” is the factory preset value.

### Digital Setup

This setting allows you to optimize the settings of Digital broadcasting.

#### Audio Setup

You can output digital audio to an AV amplifier or similar device whose DIGITAL AUDIO INPUT terminal is connected to the DIGITAL AUDIO OUTPUT terminal on the TV. Please select an audio output format compatible with the audio format of the program you are watching and the equipment connected.

**1** Press **MENU** to display the MENU screen, and then press **◀/▶** to select “Digital Setup”.

**2** Press **▲/▼** to select “Audio Setup”, and then press **ENTER**.

**3** Press **▲/▼** to select “PCM” or “Dolby Digital”, and then press **ENTER**.

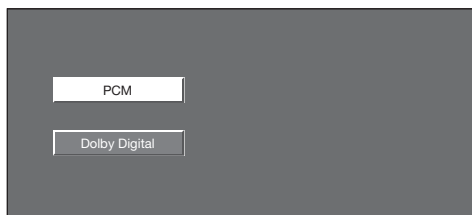

Selected item	Description
<b>PCM</b>	The optical output terminal outputs audio signal in PCM form. If your digital audio system does not support Dolby Digital, select “PCM”.
<b>Dolby Digital</b>	The optical output terminal outputs audio signal in Dolby Digital form. It reproduces sound from surround program of digital.

**4** Press **MENU** to exit.

# Using external equipment

## Displaying an external equipment image

To view external source images, select the input source from **INPUT** on the remote control unit or on the TV.

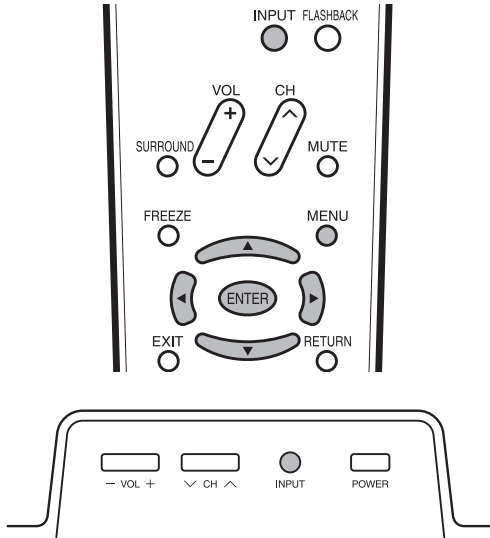

- 1 Press **INPUT**.
  - A list of selectable sources appears.

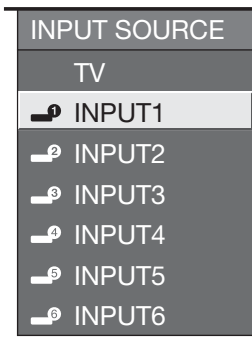

- 2 Press **INPUT** again to select the input source.
  - An image from the selected source automatically displays.
  - Each time **INPUT** is pressed, the input source toggles.
  - You can also select the input source by pressing **▲/▼**.
  - If the corresponding input is not plugged in, you cannot change the input. Be sure to connect the equipment beforehand.

### NOTE

- See pages 13 and 14 for external equipment connection.

## Input Select

If the image does not come in clearly from the external equipment connected to INPUT 1 or 2, you may need to change the input signal type setting on the "Input Select" menu.

- 1 Press **MENU** to display the MENU screen, and then press **◀▶** to select "Option".

- 2 Press **▲/▼** to select "Input Select", and then press **ENTER**.

- 3 Press **▲/▼** to select the signal type you want to set, and then press **ENTER**.
  - If the selected signal type is incorrect, images are not displayed or displayed without any color.



- 4 Press **MENU** to exit.
  - The setting is stored and can be selected on the "INPUT SOURCE" menu.

### NOTE

- Refer to your external equipment operation manual for the signal type.
- If you set INPUT 1 or 2 to Auto, the TV will automatically select the input signal.
- Setting INPUT 1 or 2 signal selection to "Auto" when other equipment is connected will result in the following connection priority.

#### INPUT 1 or 2:

- ① COMPONENT VIDEO
- ② VIDEO

## Using external equipment

### Displaying an image from HDMI equipment

- 1 To watch an HDMI/PC-IN equipment image, select "INPUT4" or "INPUT5" from "INPUT SOURCE" menu using **INPUT** on the remote control unit or on the TV.

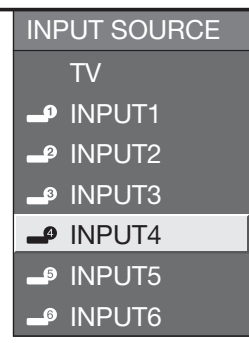

- 2 Press **MENU** to display the MENU screen, and then press **◀/▶** to select "Option".

- 3 Press **▲/▼** to select "HDMI Setup", and then press **ENTER**.

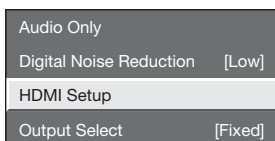

- 4 Press **▲/▼** to select the desired item, and then press **ENTER**.

- 5 Press **◀/▶** to select the desired setting, and then press **ENTER**.

HDMI Setup items	Selectable items	Description
<b>Auto View</b>	Enable Disable	Set whether or not to use View Mode based on signal recognition, including an HDMI signal.
<b>Audio Select</b>	Digital Analog	Select "Digital" for an audio signal via the HDMI terminal. Select "Analog" for an audio signal via the R-AUDIO -L terminal.

- 6 Press **MENU** to exit.

#### NOTE

- Refer to your external equipment operation manual for the signal type.
- "Audio Select" is only available for INPUT 5.
- When connecting an HDMI-DVI conversion adapter/cable to the HDMI terminal, the image may not come in clearly.

### Input Skip

This setting allows you to skip the HDMI/PC-IN Input on the Input Selection operation.

- 1 Press **MENU** to display the MENU screen, and then press **◀/▶** to select "Setup".

- 2 Press **▲/▼** to select "Input Skip", and then press **ENTER**.

- 3 Press **▲/▼** to select the Input (INPUT 4, INPUT 5 or INPUT 6) you wish to skip, and then press **ENTER**.

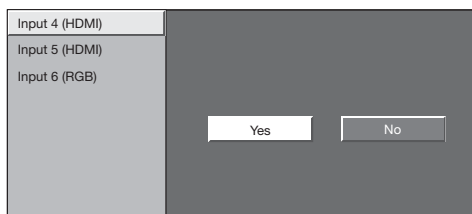

- 4 Press **◀/▶** to select "Yes", and then press **ENTER**.

- 5 Press **MENU** to exit.



# Useful adjustment settings

## Auto Sync. adjustment (for Analog PC input mode only)

For automatically adjusting the PC image.

**1** Press **MENU** to display the MENU screen, and then press **◀/▶** to select “Setup”.

**2** Press **▲/▼** to select “Auto Sync.”, and then press **ENTER**.

**3** Press **◀/▶** to select “Yes”, and then press **ENTER**.

- Auto Sync. starts and “Now adjusting the image.” displays.

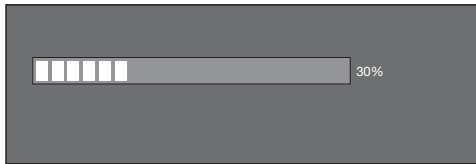
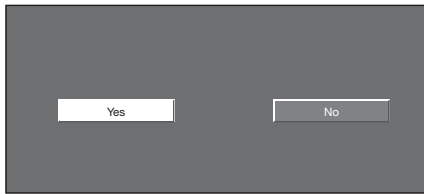

**4** Press **MENU** to exit.

### NOTE

- When Auto Sync. is successful, “Completed” displays. If not, Auto Sync. failed.
- Auto Sync. may fail even if “Completed” displays.
- Auto Sync. may fail if the computer image has low resolution, has unclear (black) edges, or is moved while executing Auto Sync.
- Be sure to connect the PC to the TV and switch it on before starting Auto Sync.

## Fine Sync. adjustment

Ordinarily you can easily adjust the picture as necessary to change image position using Auto Sync. In some cases, however, manual adjustment is needed to optimize the image.

**1** Press **MENU** to display the MENU screen, and then press **◀/▶** to select “Setup”.

**2** Press **▲/▼** to select “Fine Sync.”, and then press **ENTER**.

**3** Press **▲/▼** to select the specific adjustment item.

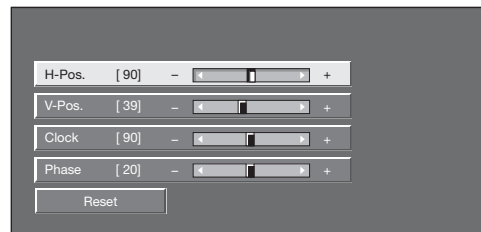

Selected item	Description
<b>H-Pos.</b>	Centers the image by moving it to the left or right.
<b>V-Pos.</b>	Centers the image by moving it up or down.
<b>Clock</b>	Adjust when the image flickers with vertical stripes.
<b>Phase</b>	Adjust when characters have low contrast or when the image flickers.

**4** Press **◀/▶** to adjust the item to your desired position.

**5** Press **MENU** to exit.

### NOTE

- For resetting all Fine Sync. adjustment items to the factory preset values, press **▲/▼** to select “Reset”, and then press **ENTER**.
- It is not necessary to adjust the “Clock” or “Phase” when a digital signal is being input, so it cannot be selected.

## Useful adjustment settings

### Language setting

You can also select a language from the Setup menu. Select from among 3 languages: English, French and Spanish.

- 1 Press **MENU** to display the MENU screen, and then press ◀/▶ to select "Setup".
- 2 Press ▲/▼ to select "Language", and then press **ENTER**.
- 3 Press ▲/▼ to select the desired language listed on the screen, and then press **ENTER**.
- 4 Press **MENU** to exit.

### Image position

For adjusting a picture's horizontal and vertical position.

- 1 Press **MENU** to display the MENU screen, and then press ◀/▶ to select "Setup".
- 2 Press ▲/▼ to select "Position", and then press **ENTER**.
- 3 Press ▲/▼ to select "H-Pos." or "V-Pos.".

#### Example

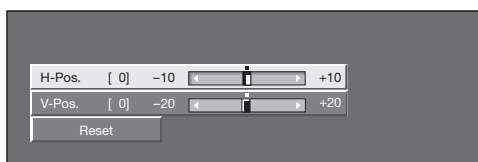

Selected item	Description
<b>H-Pos.</b>	Centers the image by moving it to the left or right.
<b>V-Pos.</b>	Centers the image by moving it up or down.

- 4 Press ◀/▶ to adjust the item to the desired position.
- 5 Press **MENU** to exit.

#### NOTE

- For resetting adjustments to the factory preset values, press ▲/▼ to select "Reset", and then press **ENTER**.
- When connecting a PC to the HDMI terminal, the image position will be automatically adjusted. It cannot be manually adjusted.
- **Adjustments are stored separately according to input source.**

### Reset

If complex adjustments are made and the settings cannot be restored to normal, you can reset the settings to the factory preset values.

- 1 Press **MENU** to display the MENU screen, and then press ◀/▶ to select "Setup".
- 2 Press ▲/▼ to select "Reset", and then press **ENTER**.
  - If you already set the Secret No., input the 4-digit secret number here. See page 40 for setting a secret number.
  - "Return to the factory preset values" displays on the screen.
- 3 Press ◀/▶ to select "Yes", and then press **ENTER**.
  - "Now, TV will restart automatically. OK?" displays on the screen.
- 4 Press ◀/▶ to select "Yes", and then press **ENTER**.
  - "Now initializing..." displays on the screen and blinks.
  - After the reset has completed, the power shuts off and then comes back on. The screen will have returned to its original settings.



#### NOTE

- The Channel Setup settings will not be changed.
- The Language settings will not be changed.
- The Secret number settings will not be changed.

## Useful adjustment settings

### Input Label

Lets you set the input terminal displayed when using the INPUT SOURCE menu or channel display.

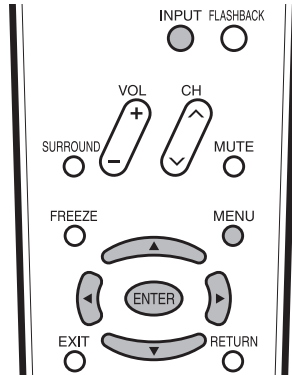

- 1 Press **INPUT** to select the desired input source.
- 2 Press **MENU** to display the MENU screen, and then press **◀▶** to select "Setup".
- 3 Press **▲▼** to select "Input Label", and then press **ENTER**.
- 4 Press **▲▼/◀▶** to select the new name for the input mode, and then press **ENTER**.

#### Example



- 5 Press **MENU** to exit.

#### NOTE

- You cannot change labels if the INPUT SOURCE is TV.

### Sleep Timer

Allows you to set a time when the TV automatically switches to standby.

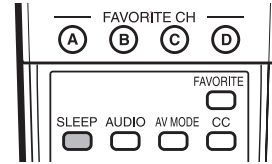

- 1 Press **SLEEP**.
  - The remaining time displays when the sleep timer has been set.

Sleep Timer: Remaining 30

- 2 Each time you press **SLEEP**, the remaining time switches as shown below.
  - When set, the time automatically starts counting down.
  - If you want to adjust the sleep timer, you can press **SLEEP** twice then change the time setting.
  - Five minutes before the time expires, the remaining time displays every minute.

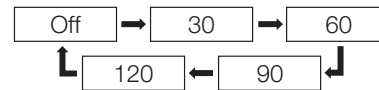

#### NOTE

- Select "Off" by pressing **SLEEP** to cancel the sleep timer.
- The TV will enter standby when the remaining time reaches zero.
- When the sleep timer is set, its indicator on the TV lights red.

## Useful adjustment settings

### View Mode for 4:3 Programs

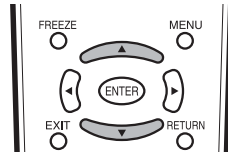
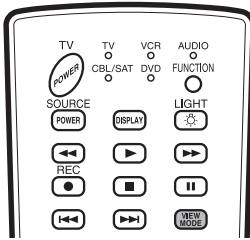

- 1 Press **VIEW MODE**.
  - The View Mode menu displays.
  - The menu lists the View Mode options selectable for the type of video signal currently being received.

#### Example

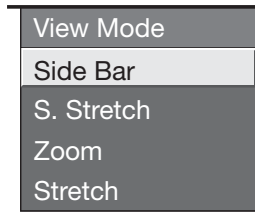

- 2 Press **VIEW MODE** or **▲/▼** while the View Mode menu is displayed to select a desired item on the menu.
  - You can sequentially select a View Mode that has its own aspect ratio.

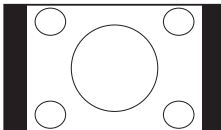

**Side Bar:**  
Suitable for viewing conventional 4:3 programs in their normal format.

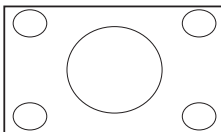

**S.Stretch (Smart stretch):**  
Suitable for stretching 4:3 programs to fill the screen.

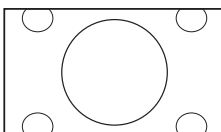

**Zoom:**  
Suitable for viewing wide-screen 2.35:1 anamorphic DVDs in full screen.

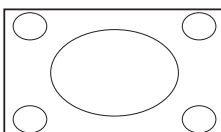

**Stretch:**  
This mode is useful for 1.78:1 DVDs.  
When viewing 1.85:1 DVDs, stretch mode will still show very thin black bands at the top and bottom of the screen.

### View Mode for HD Programs

Stretch mode is available for HD programs. Suitable for viewing wide-screen 1.78:1 aspect-ratio programs. When viewing 1.85:1 programs, the stretch mode will still show very thin black bands at the top and bottom of the screen.

## Useful adjustment settings

### View Mode (for PC input mode)

You can select the screen size.

#### NOTE

- Connect the PC before making adjustments. (See page 14.)
- Selectable screen size may vary with input signal type.

- 1 Press **VIEW MODE**.
  - The View Mode menu displays.

#### Example

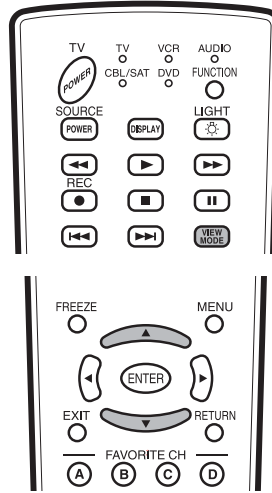
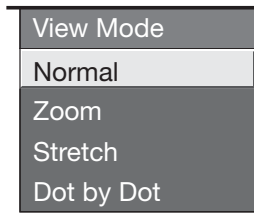

- 2 Press **VIEW MODE** or **▲/▼** while the View Mode menu is displayed to select a desired item on the menu.

#### Example: Screen size images

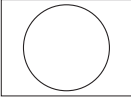
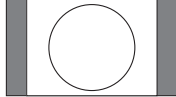
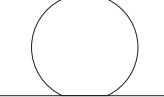
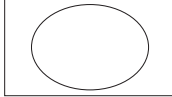
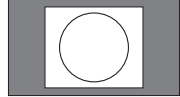
Input signal	Normal	Zoom	Stretch	Dot by Dot
 <p>4:3</p>	 <p>Keeps the original aspect ratio in a full screen display.</p>	 <p>For viewing wide-screen programs. The top and bottom of the image is cropped.</p>	 <p>An image fully fills the screen.</p>	 <p>Detects the resolution of the signal and displays an image with the same number of pixels on the screen.</p>

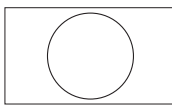
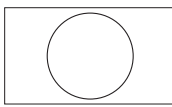
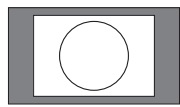
Input signal	Stretch	Dot by Dot
 <p>16:9</p>	 <p>An image fully fills the screen.</p>	 <p>Detects the resolution of the signal and displays an image with the same number of pixels on the screen.</p>

## Useful adjustment settings

### Advanced Option settings

Perform the following steps to set the Option menu items on this page.

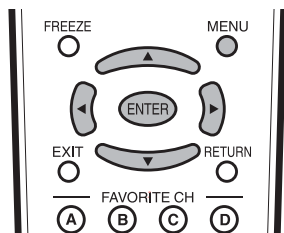

- 1 Press **MENU** to display the MENU screen, and then press **◀/▶** to select "Option".
- 2 Press **▲/▼** to select a specific adjustment item, and then press **ENTER**.
- 3 Press **▲/▼** (or **◀/▶**) to select the desired setting, and then press **ENTER**.
- 4 Press **MENU** to exit.
  - Skip this step for "Audio Only".

### Audio Only

When listening to music from a music program, you can set the screen off and enjoy audio only.

Selected item	Description
<b>On</b>	Audio is output without screen image.
<b>Off</b>	Both screen images and audio are output.

#### NOTE

- The screen image will return to normal when a button (except those for audio adjustment, such as **VOL**, **MUTE**, **SURROUND**, **AUDIO**) is pressed.

### Digital Noise Reduction

Produces a clearer video image.

Selected item	Description
<b>Off</b>	No adjustment
<b>High</b>	For enhanced Digital Noise Reduction
<b>Low</b>	For moderate Digital Noise Reduction

### Output Select

Allows you to select what controls the audio output.

Selected item	Description
<b>Fixed</b>	<ul style="list-style-type: none"> <li>• Sound via speaker is adjusted with <b>VOL +/–</b> on the remote control unit or <b>VOL –/+</b> on the TV.</li> <li>• Sound via the AUDIO OUTPUT terminal is not adjustable and outputs at a consistent level.</li> </ul>
<b>Variable</b>	<ul style="list-style-type: none"> <li>• Sound via the AUDIO OUTPUT terminal is adjusted with <b>VOL +/–</b> on the remote control unit or <b>VOL –/+</b> on the TV.</li> <li>• Sound via speaker is muted.</li> </ul>

### Color System

Select the video signal system compatible with your equipment from the list below;

- Auto
- NTSC
- PAL-M
- PAL-N

#### NOTE

- "Color System" can only be set for the INPUT 1 VIDEO, INPUT 2 VIDEO and INPUT 3.
- If you already set the Secret No., input the 4-digit secret number here. See page 40 for setting a secret number.

### Program Title Display

Select the CH display when changing channels for digital broadcasting.

Selected item	Description
<b>Yes</b>	"Program Info." displays
<b>No</b>	"Program Info." does not display

## Useful adjustment settings

### AV MODE

AV MODE gives you 7 viewing options to choose from to best match the surrounding environment of the TV, which can vary due to factors like room brightness, type of program watched or the type of image input from external equipment.

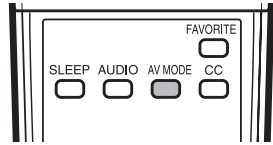

- 1 Press **AV MODE**.
  - Current AV MODE displays.

- 2 Press **AV MODE** again before the mode displayed on the screen disappears.
  - The mode changes as shown below.

When the input source is TV, INPUT 1, 2 or 3 terminals  
(Example)

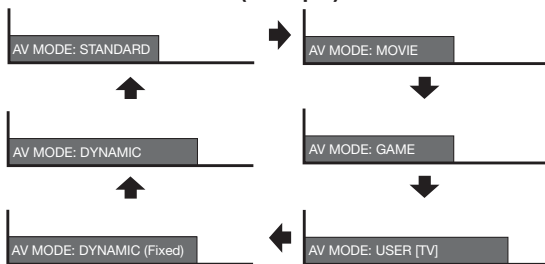

When the input source is INPUT 4, 5 or 6 terminals  
(Example)

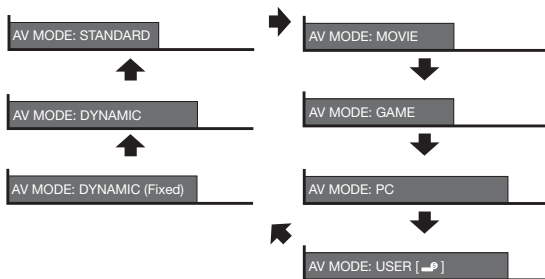

#### NOTE

- You can select a different AV MODE item for each input mode. (For example, select STANDARD for TV input and DYNAMIC for INPUT 1.)
- “Enhanced Picture Contrast” technology detects the source video characteristics and smoothly adjusts the screen brightness accordingly to realize deeper black levels.

Selected item	Description
<b>STANDARD</b>	For a highly defined image in a normal lighting [Enhanced Picture Contrast: on]
<b>MOVIE</b>	For a movie [Enhanced Picture Contrast: off]
<b>GAME</b>	Lowers image brightness for easier viewing [Enhanced Picture Contrast: off]
<b>PC</b>	For PC [Enhanced Picture Contrast: off]
<b>USER</b>	Allows the user to customize settings as desired. You can set the mode for each input source. [Enhanced Picture Contrast: off]
<b>DYNAMIC (Fixed)</b>	Changes the image and sound settings to the factory preset values. No adjustments are allowed. [Enhanced Picture Contrast: on]
<b>DYNAMIC</b>	For a clear-cut image emphasizing high contrast, useful for sports viewing [Enhanced Picture Contrast: on]

### Input Signal (for Analog PC input mode only)

Some input signals may have to be registered manually to display properly.

The pair of input signals (resolutions) in the list below are not distinguishable when received. In such case, you have to set the correct signal manually. After setting once, it will display when the same signal (resolution) is input again.

1024 × 768

1360 × 768

#### NOTE

- You can only select the “Input Signal” on the Setup menu when receiving one of the 2 input signals listed above.

- 1 Press **MENU** to display the MENU screen, and then press ◀▶ to select “Setup”.
- 2 Press ▲/▼ to select “Input Signal”, and then press **ENTER**.
- 3 Press ▲/▼ to select the desired input signal on the display.
- 4 Press **MENU** to exit.

## Useful adjustment settings

### Closed Captions and Digital Closed Captions

Your TV is equipped with an internal Closed Caption decoder. It allows you to view conversations, narration and sound effects as subtitles on your TV. Closed Captions are available on some TV programs and on some VHS home video tapes at the discretion of the program provider.

Digital Closed Caption service is a new caption service available only on digital TV programs (also at the discretion of the service provider). It is a more flexible system than the original Closed Caption system, because it allows for a variety of caption sizes and font styles. When the Digital Closed Caption service is in use, it will be indicated by the appearance of a 3-letter abbreviation that also indicates the language of the Digital Closed Captions: ENG (English), SPA (Spanish), FRA (French) or other language codes.

Not all programs and VHS videotapes offer closed captions. Please look for the “**CC**” symbol to ensure that captions will be shown.

In the Closed Caption system, there can be more than one caption service provided. Each is identified by its own number. The “CC1” and “CC2” services display subtitles of TV programs superimposed over the program's picture.

In the Closed Caption system, the “Text1” or “Text2” services display text that is unrelated to the program being viewed (e.g., weather or news). These services are also superimposed over the program currently being viewed.

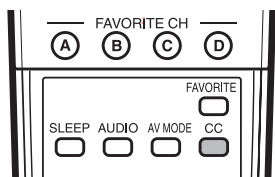

#### 1 Press **CC**.

- This will present the Closed Caption information display.

#### 2 Press **CC** while the Closed Caption information is still on the screen.

- Press repeatedly until you select the desired closed caption service.

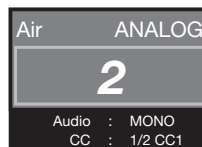

Closed Caption information

- Depending on the number of caption services in the signal being received, you will see information such as 1/2 or 1/4 displayed.

1/2 means “the first of two services”.

Example:

If a program has three services (Digital CC(ENG), CC1 and Text1), the closed caption display will toggle in this sequence:

1/3 ENG → 2/3 CC1 → 3/3 Text1 → Off

- The CC button keeps a record of the last service selected in its memory.

If the last closed caption mode (e.g. 1/3ENG) you selected is not available for the next program, or on another channel, the closed caption service that is available is automatically selected, and this service appears in parentheses, e.g. “1/3(CC1)”. Closed Caption services that appear in parentheses will not be stored in the CC button's memory as your last selected service. Only services that you have selected with the CC button are stored.

#### Examples:

In a case where there are two closed caption services provided, (for instance, Digital CC(ENG) and CC1), and Digital CC(ENG) is displayed as your current selection, if Digital CC(ENG) is not broadcast for the next program, the other closed caption service, CC1, will be displayed in parentheses.

A closed caption service appears in parentheses because the service you selected is not available and a different service is displayed on your screen. “1/1(CC1)” is displayed instead of “1/2/ENG”.

#### NOTE

- See page 39 for detailed closed caption settings.
- When the program contains no closed caption, “--” displays in the closed caption information.
- If the language code, e.g. “ENG”, is not found on Digital TV programs, “--” will be shown.
- Four kinds of closed caption service (CC1, CC2, Text1, Text2) are potentially available, but a broadcast may contain none or only some of these services at the discretion of the program provider.



## Useful adjustment settings

### Caption Setup

This function allows you to adjust the closed caption screen appearance to suit your preference.

**1** Press **MENU** to display the MENU screen, and then press ◀/▶ to select “Option”.

**2** Press ▲/▼ to select “Caption Setup”, and then press **ENTER**.

**3** Press ▲/▼ to select a specific adjustment item.

- You can adjust 7 items here; they are,

- ① “Caption Size”,
- ② “Font Style”,
- ③ “Foreground Color”,
- ④ “Foreground Opacity”,
- ⑤ “Background Color”,
- ⑥ “Background Opacity” and
- ⑦ “Character Edge”.

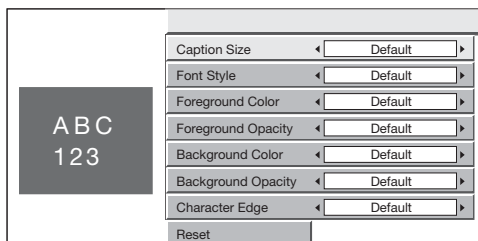

**4** Press ◀/▶ to select the desired parameter.

**5** Press **MENU** to exit.

### NOTE

- For resetting adjustments to the factory preset values, press ▲/▼ to select “Reset”, and then press **ENTER**.
- The default value depends on the broadcasting station.

### Selectable items available for “Font Style”.

Selected item	Description
<b>Default</b>	The font specified by broadcasting station or default font.
<b>Type 0</b>	Proportional font used in the MENU screen.
<b>Type 1</b>	Monospaced with serifs.
<b>Type 2</b>	Proportionally spaced with serifs.
<b>Type 3</b>	Monospaced without serifs.
<b>Type 4</b>	Proportionally spaced without serifs.
<b>Type 5</b>	Casual font type.
<b>Type 6</b>	Cursive font type.
<b>Type 7</b>	Small capitals.

## Useful adjustment settings

### Secret number setting for parental control

Allows you to use a secret number to protect certain settings from being accidentally changed.

#### IMPORTANT:

Three conditions must be met to enable the V-Chip (see pages 40 to 45):

- ① Secret No. is registered.
- ② V-Chip/V-Chip (DTV Only) settings have been made.
- ③ "Status" is set to "On".

#### Setting a secret number

**1** Press **MENU** to display the MENU screen, and then press **◀/▶** to select "Setup".

**2** Press **▲/▼** to select "Parental CTRL", and then press **ENTER**.

**3** Press **▲/▼** to select "Secret No.", and then press **ENTER**.



**4** Select "New Secret No.", and then press **ENTER**.  
Input the new 4-digit secret number by using **0-9**.

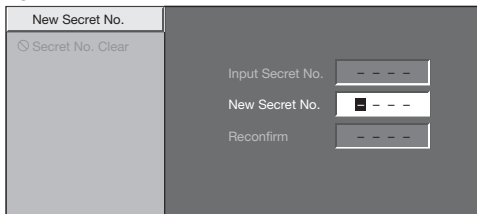

**5** Input the same 4-digit number on the "Reconfirm" screen as in step 4 to confirm.

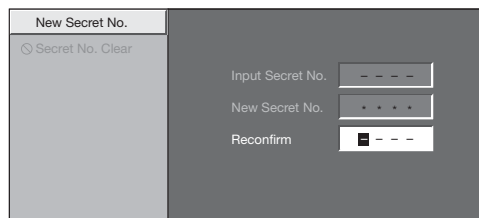

**6** Press **RETURN** to start configuring the V-Chip settings. (See pages 43 and 45 for details.)

**7** Press **MENU** to exit.

#### Setting parental control status

Used to enable or disable the parental control function.

**1** Repeat steps 1 and 2 in **Setting a secret number**.

- The secret number setting menu displays.

**2** Input the 4-digit secret number by using **0-9**.

**3** Press **▲/▼** to select "Status", and then press **ENTER**.

**4** Press **◀/▶** to select "On" or "Off", and then press **ENTER**.

- Select "On" to enable and "Off" to disable Parental CTRL.

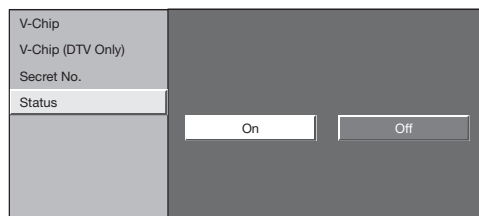

**5** Press **MENU** to exit.

#### NOTE

- You can skip steps 1 and 2 above while in the Parental CTRL screen.
- The "V-Chip (DTV Only)" will only be selectable when a new rating system can be downloaded via digital broadcasting in the U.S.

## Useful adjustment settings

### Changing the secret number

Allows you to change your current secret number.

- 1 Repeat steps 1 and 2 in **Setting a secret number**.
  - The secret number setting menu displays.
- 2 Input the 4-digit secret number by using **0–9**.
- 3 Press **▲/▼** to select “Secret No.”, and then press **ENTER**.
- 4 Press **▲/▼** to select “New Secret No.”, and then press **ENTER**.
- 5 Input the old 4-digit secret number by using **0–9**.

New Secret No.  
Secret No. Clear  
Input Secret No. ■ - - -  
New Secret No. - - - -  
Reconfirm - - - -

- 6 Input the new 4-digit secret number by using **0–9**.

New Secret No.  
Secret No. Clear  
Input Secret No. - - - -  
New Secret No. \* \* \* \*  
Reconfirm - - - -

- 7 Input the same 4-digit number on the “Reconfirm” screen as in step 6 to confirm.

New Secret No.  
Secret No. Clear  
Input Secret No. - - - -  
New Secret No. \* \* \* \*  
Reconfirm ■ - - -

- 8 Press **MENU** to exit.

### Clearing the secret number

Allows you to clear your secret number.

- 1 Repeat steps 1 and 2 in **Setting a secret number**.
  - The secret number setting menu displays.
- 2 Input the 4-digit secret number by using **0–9**.
- 3 Press **▲/▼** to select “Secret No.”, and then press **ENTER**.
- 4 Press **▲/▼** to select “Secret No. Clear”, and then press **ENTER**.
- 5 Press **◀/▶** to select “Yes”, and then press **ENTER**.
  - Your secret number is cleared.

New Secret No.  
Secret No. Clear  
Yes No

- 6 Press **MENU** to exit.

#### NOTE

- See page 40 for re-registering a new secret number after being cleared.
- **As a precautionary measure, make a note of your secret number and keep it in a familiar place.**
- If the secret number is cleared, the Status setting automatically sets to “Off”. “V-Chip” and “Status” will not be selectable from the menu.

## Useful adjustment settings

### Parental control (setting V-CHIP level)

V-CHIP is an electronic filtering device built into your TV. This tool gives parents a great degree of control over broadcasts accessed by their children. It allows parents to select programs judged suitable for child viewing while blocking ones judged not suitable. It does so automatically once you activate the V-CHIP feature in your TV.

**“V-Chip” and “Status” will not be selectable from the menu if you do not first configure your secret number.** (See page 40 for Secret number setting for parental control.)

- The U.S. has two rating systems for viewing content: TV Parental Guidelines and movie ratings.
- The TV Parental Guidelines work in conjunction with the V-CHIP to help parents screen out inappropriate television shows from their children.
- Movie ratings are used for original movies rated by the Motion Picture Association of America (MPAA) as watched on cable TV and not edited for television. The V-CHIP can also be set to block MPAA-rated movies.

### Voluntary movie rating system (MPAA)

Rating	Description	
Age	G	General audiences. All ages admitted.
	PG	Parental guidance suggested. Some material may not be suitable for children.
	PG-13	Parents strongly cautioned. Some material may be inappropriate for children under 13.
	R	Restricted. Under 17 requires accompanying parent or adult guardian (age varies in some jurisdictions).
	NC-17	No one 17 and under admitted.
	X	X is an older rating that is unified with NC-17 but may be encoded in the data of older movies.

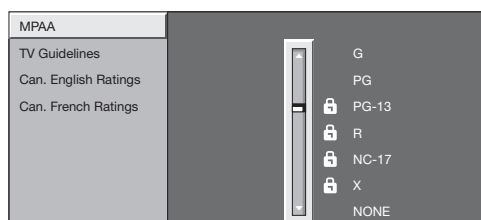

#### EXAMPLE

- If you select “PG-13”, this will automatically block the higher ratings “R”, “NC-17” and “X”.

#### NOTE

- Voluntary movie rating system only uses an age-based rating.

### TV Parental Guidelines

Rating	Content					
	FV (Fantasy violence)	V (Violence)	S (Sexual situation)	L (Adult language)	D (Sexually suggestive dialog)	
Suggested age	TV-Y (All children)	☒	☒	☒	☒	☒
	TV-Y7 (Directed to older children)	×	☒	☒	☒	☒
	TV-G (General audience)		☒	☒	☒	☒
	TV-PG (Parental Guidance suggested)		×	×	×	×
	TV-14 (Parents strongly cautioned)		×	×	×	×
	TV-MA (Mature audience only)		×	×	×	

☒: The content rating can be set, but this rating is not normally broadcast by TV stations.

×: Content rating can be set.

## Useful adjustment settings

### Voluntary movie rating system (MPAA)

**1** Press **MENU** to display the MENU screen, and then press **◀/▶** to select "Setup".

**2** Press **▲/▼** to select "Parental CTRL", and then press **ENTER**.

- The secret number setting menu displays only when "Secret No." is set. (See page 40.)
- "V-Chip" and "Status" will not be selectable from the menu if you do not first configure your secret number. (See page 40.)

**3** Input the 4-digit secret number by using **0-9**.

**4** Press **▲/▼** to select "V-Chip", and then press **ENTER**.



**5** Press **▲/▼** to select "MPAA", and then press **ENTER**.

**6** Press **▲/▼** to adjust the item to your desired position. "🔒" indicates the item is blocked. Press **RETURN**.

- The setting automatically enters "Block" for any ratings below your selection.
- If Status is not set to "On", the configuration settings will not work. (See page 40.)

#### Example

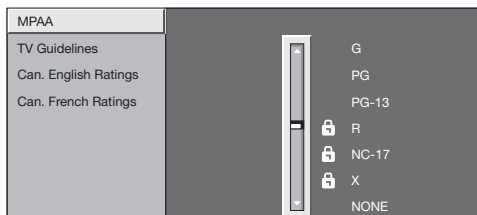

**7** Press **MENU** to exit.

### TV Parental Guidelines (TV Guidelines)

**1** Repeat steps 1 to 4 in **Voluntary movie rating system (MPAA)**.

**2** Press **▲/▼** to select "TV Guidelines", and then press **ENTER**.

**3** Press **▲/▼** to adjust the item to your desired position. "🔒" indicates the item is blocked.

- The setting automatically enters "Block" for any ratings below your selection.

#### Example



When setting an individual content-based rating item, do as follows:

- ① Press **▶** or **ENTER** to access blocked content items from the currently selected age-based rating item.
- ② Press **▲/▼** to select an individual item, and then press **ENTER** to unblock it ("🔒" is removed). Repeat the same steps for the other items.
- ③ Press **◀** or **RETURN** to register after all individual content rating items are set.

#### Example



- If Status is not set to "On", the configuration settings will not work. (See page 40.)

**4** Press **MENU** to exit.

## Useful adjustment settings

### Canadian Rating Systems

- The TV rating systems in Canada are based on the Canadian Radio-Television and Telecommunications Commission (CRTC) policy on violence in television programming.
- While violence is the most important content element to be rated, the structure developed takes into consideration other program content like language, nudity, sexuality and mature themes.
- When setting the V-CHIP on the Canadian system you can choose either the Canadian English ratings or the Canadian French ratings.

### Canadian English ratings

	Rating	Description
Age	E	Exempt: Includes news, sports, documentaries and other information programming; talk shows, music videos, and variety programming.
	C	Children: Intended for younger children under the age of 8 years. Pays careful attention to themes that could threaten their sense of security and well-being.
	C8+	Children over 8 years old: Contains no portrayal of violence as the preferred, acceptable, or only way to resolve conflict; nor encourage children to imitate dangerous acts which they may see on the screen.
	G	General: Considered acceptable for all age groups. Appropriate viewing for the entire family, contains very little violence, physical, verbal or emotional.
	PG	Parental Guidance: Intended for a general audience, but may not be suitable for younger children (under the age of 8) because it could contain controversial themes or issues.
	14+	Over 14 Years: Could contain themes where violence is one of the dominant elements of the storyline, but it must be integral to the development of plot or character. Language usage could be profane and nudity present within the context of the theme.
	18+	Adults: Intended for viewers 18 years and older and might contain depictions of violence, which while related to the development of plot, character or themes, are intended for adult viewing. Could contain graphic language and portrayals of sex and nudity.

### Canadian French ratings

	Rating	Description
Age	E	Exempt programming.
	G	General: All ages and children, contains minimal direct violence, but may be integrated into the plot in a humorous or unrealistic manner.
	8ans +	General but inadvisable for young children: May be viewed by a wide public audience, but could contain scenes disturbing to children under 8 who cannot distinguish between imaginary and real situations. Recommended for viewing with parent.
	13ans +	Over 13 years: Could contain scenes of frequent violent scenes and therefore recommended for viewing with parent.
	16ans +	Over 16 years: Could contain frequent violent scenes and intense violence.
	18ans +	Over 18 years: Only for adult viewing. Could contain frequent violent scenes and extreme violence.

## Useful adjustment settings

### Canadian English ratings

**1** Press **MENU** to display the MENU screen, and then press **◀/▶** to select “Setup”.

**2** Press **▲/▼** to select “Parental CTRL”, and then press **ENTER**.

- Secret number setting menu displays only when “Secret No.” is set. (See page 40.)
- “V-Chip” and “Status” will not be selectable from the menu if you do not first configure your secret number. (See page 40.)

**3** Input the 4-digit secret number by using **0–9**.



**4** Press **▲/▼** to select “V-Chip”, and then press **ENTER**.



**5** Press **▲/▼** to select “Can. English Ratings”, and then press **ENTER**.

**6** Press **▲/▼** to adjust the item to your desired position. “**🔒**” indicates the item is blocked.

- The setting automatically enters “Block” for any ratings below your selection.
- If Status is not set to “On”, the configuration settings will not work. (See page 40.)

#### Example

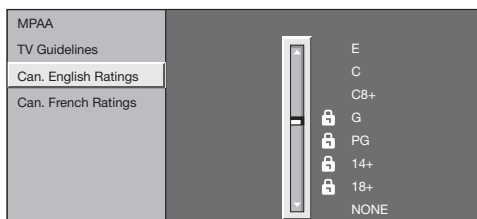

**7** Press **MENU** to exit.

### Canadian French ratings

**1** Repeat steps 1 to 4 in **Canadian English ratings**.

**2** Press **▲/▼** to select “Can. French Ratings”, and then press **ENTER**.

**3** Press **▲/▼** to adjust the item to your desired position. “**🔒**” indicates the item is blocked.

- The setting automatically enters “Block” for any ratings below your selection.
- If Status is not set to “On”, the configuration settings will not work. (See page 40.)

#### Example

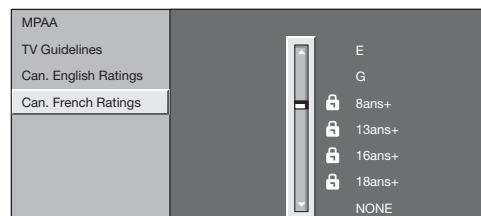

**4** Press **MENU** to exit.

## How to temporarily release the V-CHIP BLOCK

When the V-CHIP BLOCK is working and censors a broadcast, “V-CHIP HAS BEEN ACTIVATED.” displays.

**1** Press **ENTER** while the V-CHIP is working, and then the secret number setting menu displays.

**2** Input the 4-digit secret number by using **0–9**. At this time V-CHIP BLOCK temporarily releases.

## Reactivating the temporarily released V-CHIP BLOCK

You can reactivate the temporarily released V-CHIP BLOCK as shown below.

### Method 1:

Select “Status” setting from the Parental CTRL menu to reactivate BLOCK. (See page 40.)

### Method 2:

Select “V-Chip” setting (“MPAA”, “TV Guidelines”, “Can. English Ratings” or “Can. French Ratings”) from the Parental CTRL to reactivate BLOCK. (See pages 43 and 45.)

### Method 3:

Switch off the TV power.

### NOTE

- Performing any of the three above will activate the V-CHIP BLOCK.

# Other viewing options

## Freezing images

Allows you to capture and freeze a moving image that you are watching.

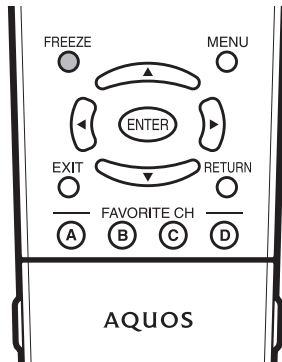

- 1 Press **FREEZE**.
  - A moving image is captured.
- 2 Press **FREEZE** again to cancel the function.

### NOTE

- When this function is not available, "No displaying still image available." will display.
- The still image automatically goes out after 30 minutes.
- If you are using the freeze function and a broadcast activates the V-CHIP BLOCK, the freeze function will be cancelled and a V-CHIP BLOCK message will appear.

## Presetting remote control function

You can operate the connected AV products (AV Receiver, Cable Box, SAT tuner, DTV, VCR, DVD, LD) using the presetting manufacturer function of your remote control unit.

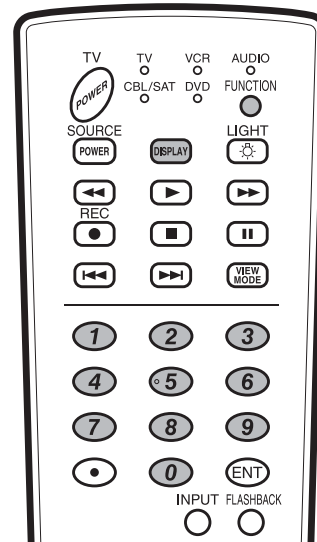

## Presetting manufacturer codes

- 1 Press **FUNCTION** until the LED for your device lights up.
- 2 After the LED for your device lights up, press **FUNCTION** and **DISPLAY** at the same time to enter the code registration mode. The LED will blink.
- 3 Press **0-9** to enter the manufacturer code. (See page 47.)
  - Preset mode is finished once the LED no longer lights up.
- 4 After registering the code, the LED will stop blinking then turn off after one second. (If you perform an incorrect operation, the LED will blink quickly then turn off.)



## Other viewing options

### Manufacturer codes

VCR BRAND	REMOTE CONTROL CODE NUMBER
Akai	25, 26, 37
Audio	15, 22, 30
Broksonic	32
Canon	04
Capehart	34
Craig	10, 31
Curtis Mathis	04
Daewoo	34
DBX	15, 22, 30
Dynatech	29
Emerson	21, 32, 35
Fisher	09, 10, 11
Funai	28, 29
G.E.	04
Goldstar	24
Hitachi	06, 47
Instant Replay	04
JC Penney	04, 06, 24, 30
JVC	15, 41, 42, 53
Kenwood	14, 15
Lloyds	29
Magnavox	04, 05, 08
Magnin	31
Marantz	30
Memorex	04, 10, 24, 29
Minolta	06
Mitsubishi	17, 18, 39, 40
Montgomery Ward	02, 43
Multitech	29
NEC	15, 22, 30
Panasonic	44, 45
Pentax	05, 06
Philco	05
Philips	05, 08
RCA	06, 07, 33, 51
Realistic	01, 02, 10, 24
Samsung	23, 31
Sanyo	10, 14, 52
Scott	20
Sears	06, 11, 24
Sharp	01, 02, 03
Shintom	36
Sony	12, 13, 38
Sound Design	29
Sylvania	05, 08
Symphonic	29
Tatung	15
Teac	15, 29
Teknika	27, 29
Thomas	29
TMK	21
Toshiba	19, 20
Video Concepts	30
Yamaha	15, 29, 30
Zenith	16

DVD/LD BRAND	REMOTE CONTROL CODE NUMBER
Denon	02
JVC	09, 13
Kenwood	21
Magnavox	04
Marantz	04
Mitsubishi	06
Panasonic	02, 22
Philips	04, 23
Pioneer	08, 11, 20
Proscan	03
RCA	03, 24
Samsung	07, 12
Sharp	01, 10
Sony	05, 25
Toshiba	04
Yamaha	02
Zenith	04

CATV/SAT BRAND	REMOTE CONTROL CODE NUMBER
Anvision	04, 05
Cable Star	04, 05
Eagle	05
General Instrument	02, 03, 07, 12, 13, 14, 19, 22
Jerrold	02, 03, 07, 12, 13, 14, 19, 22, 31, 32, 33, 34, 35, 36, 37, 38, 39, 40
Magnavox	04, 05, 09, 14, 17, 18, 20, 21, 24, 25
Oak Sigma	8
Panasonic	16, 23
Philips	04, 05, 09, 15, 17, 18, 20, 21, 24, 25
Pioneer	08, 10, 29, 30, 43*, 46
Randtek	04, 05
RCA	16, 27, 44*, 45*
Scientific Atlanta	01, 26
Sony	28
Viewstar	04, 05, 09, 15, 17, 18, 20, 21, 24, 25
Zenith	06, 14

#### NOTE

- Numbers marked with \* are SAT codes, all others are CATV codes.

AUDIO BRAND	REMOTE CONTROL CODE NUMBER
Sharp	01

## Other viewing options

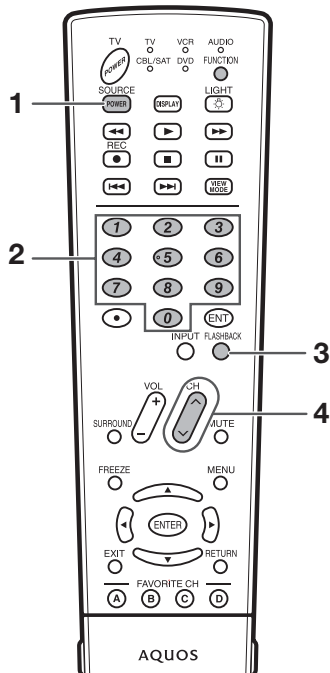

### ■ Cable control buttons

When the **FUNCTION** is set to CBL/SAT, the cable converter connected to the TV can be operated using **1 to 4**.

#### 1 SOURCE POWER

Turns the cable converter power on and off.

#### 2 0-9

Press a button (or buttons) that corresponds to the channel that you wish to watch.

#### 3 FLASHBACK \*

Press to switch between the current channel and the channel you were watching immediately before.

#### 4 CH ^/∇

Press **CH ^** or **CH ∇** to tune in to a higher or lower channel.

\* Some manufacturers do not preset **FLASHBACK**.

#### NOTE

- CABLE and SAT cannot be selected at the same time.

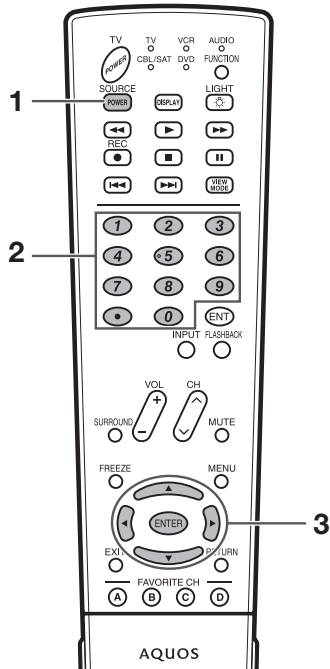

### ■ SAT control buttons

#### 1 SOURCE POWER

Turns the cable converter power on and off.

#### 2 0-9, • (DOT)

Press a button (or buttons) that corresponds to the channel that you wish to watch.

#### 3 ENTER, ▲/▼/◀/▶

**ENTER:** Press to activate the selected function.

**▲/▼/◀/▶:** Press the button to select items on the SAT GUIDE screen or SAT MENU screen.

#### NOTE

- CABLE and SAT cannot be selected at the same time.

## Other viewing options

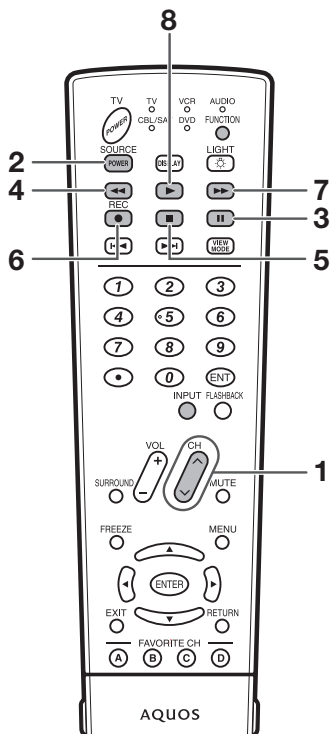

### ■ VCR control buttons

The remote control unit button will function as follows when the **FUNCTION** of the remote control unit is set to VCR.

- Press **INPUT** until the input connected to the VCR is selected. The following 1 to 8 can be used to control the VCR.

- 1 CH ▲/▼**  
Press to select the channel of the TV tuner on the VCR.
- 2 SOURCE POWER**  
Turns the power of the VCR on and off.
- 3 ||**  
Sets pauses and still pictures.
- 4 ◀◀**  
Rewinds the tape and allows picture search.
- 5 ■**  
Stops the tape transport.
- 6 REC**  
Starts recording.
- 7 ▶▶**  
Rapidly advances the tape and allows picture search.
- 8 ▶**  
Starts playback.

### ■ DVD control buttons

The remote control unit button will function as follows when the **FUNCTION** of the remote control unit is set to DVD.

- Press **INPUT** until the input connected to the DVD player is selected. The following 1 to 10 can be used to control the DVD player.

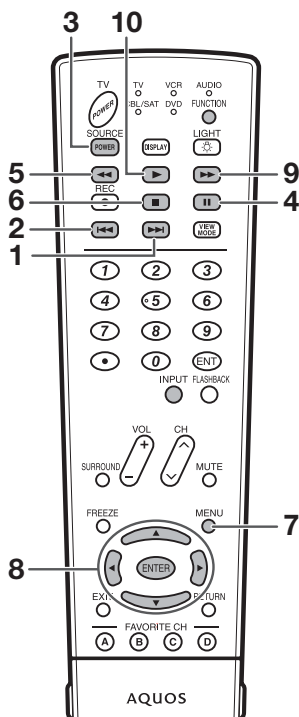

- 1 ▶▶**  
Pressing quickly once takes you to the start of the next chapter. Each time you press it, you move ahead to the start of the next chapter.
- 2 ◀◀**  
Pressing quickly once takes you to the start of the chapter currently playing. Each time you press it, you move back to the start of the previous chapter.
- 3 SOURCE POWER**  
Turns the power of the DVD player on and off.
- 4 ||**  
Sets pauses and still pictures.
- 5 ◀◀**  
Hold down to go in reverse.
- 6 ■**  
Playback stops when pressed.  
With some DVD players, pressing the button twice may open the disc tray.
- 7 MENU**  
When this button is pressed, the DVD menu will display.
- 8 ENTER, ▲/▼/◀/▶**  
**ENTER:** Press to activate the selected function.  
**▲/▼/◀/▶:** Press the button to select items on the DVD MENU screen.
- 9 ▶▶**  
Hold down to fast forward.
- 10 ▶**  
Starts playback.

# Appendix

## Removing the stand

Before detaching (or attaching) stand, unplug the AC cord from the AC INPUT terminal.

### CAUTION

- Do not remove the stand from the TV unless using an optional wall mount bracket to mount it.

### Before attaching/detaching stand

- Before performing work make sure to turn off the TV.
- Before performing work spread cushioning over the base area to lay the TV on. This will prevent it from being damaged.

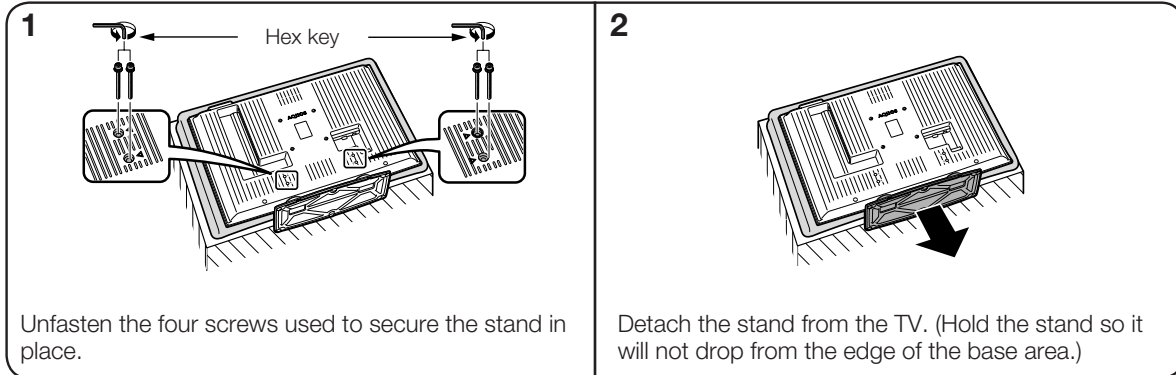

### NOTE

- To attach the stand, perform the above steps in reverse order.

## Setting the TV on the wall

### CAUTION

- This TV should be mounted on the wall only with the AN-52AG1 (SHARP) wall mount bracket. The use of other wall mount brackets may result in an unstable installation and may cause serious injuries.
- Installing the TV requires special skill that should only be performed by qualified service personnel. Customers should not attempt to do the work themselves. SHARP bears no responsibility for improper mounting or mounting that results in accident or injury.

### Using an optional bracket to mount the TV

- You can ask a qualified service professional about using an optional AN-52AG1 bracket to mount the TV to the wall.
- Carefully read the instructions that come with the bracket before beginning work.

#### Hanging on the wall

AN-52AG1 wall mount bracket.  
(See the bracket instructions for details.)

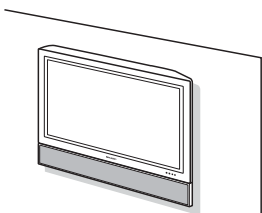
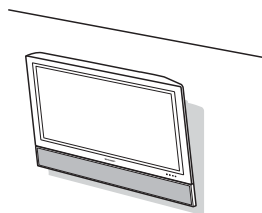
Vertical mounting
Angular mounting

#### About setting the TV angle and height adjustment

<b>① Angle of TV</b>	0/5/10/15/20°
<b>② Height Adjustment</b>	- 1 <sup>63</sup> / <sub>64</sub> (-5)/0/ + 1 <sup>63</sup> / <sub>64</sub> (+5) • can be moved 1 <sup>63</sup> / <sub>64</sub> (5) up or down Unit: inch (cm)

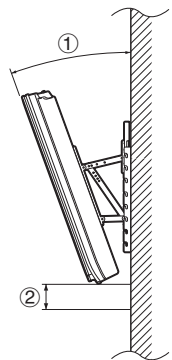

### NOTE

- Detach the cable clamps on the rear of the TV when using the optional mount bracket.

## Appendix

### Troubleshooting

Problem	Possible Solution
<ul style="list-style-type: none"> <li>No power</li> </ul>	<ul style="list-style-type: none"> <li>Check if you pressed <b>TV POWER</b> on the remote control unit. (See page 15.) If the indicator on the TV does not light up, press <b>POWER</b> on the TV.</li> <li>Is the AC cord disconnected? (See page 7.)</li> <li>Has the power been turned on? (See page 15.)</li> </ul>
<ul style="list-style-type: none"> <li>Unit cannot be operated.</li> </ul>	<ul style="list-style-type: none"> <li>External influences such as lightning, static electricity, may cause improper operation. In this case, operate the unit after first turning on the power of the TV or unplugging the AC cord and replugging it in after 1 or 2 minutes.</li> </ul>
<ul style="list-style-type: none"> <li>Remote control unit does not operate.</li> </ul>	<ul style="list-style-type: none"> <li>Is the <b>FUNCTION</b> set correctly? Set it to the TV setting position.</li> <li>Are batteries inserted with polarity (+, -) aligned? (See page 8.)</li> <li>Are batteries worn out? (Replace with new batteries.)</li> <li>Are you using it under strong or fluorescent lighting?</li> <li>Is a fluorescent light illuminated near the remote control sensor?</li> </ul>
<ul style="list-style-type: none"> <li>Picture is cut off/with sidebar screen.</li> </ul>	<ul style="list-style-type: none"> <li>Is the image position correct? (See page 32.)</li> <li>Are screen mode adjustments such as picture size made correctly? (See pages 34 and 35.)</li> </ul>
<ul style="list-style-type: none"> <li>Strange color, light color, or color misalignment</li> </ul>	<ul style="list-style-type: none"> <li>Adjust the picture tone. (See pages 25 to 26.)</li> <li>Is the room too bright? The picture may look dark in a room that is too bright.</li> <li>Check the input signal setting. (See page 37.)</li> </ul>
<ul style="list-style-type: none"> <li>Power is suddenly turned off.</li> </ul>	<ul style="list-style-type: none"> <li>Is the sleep timer set? (See page 33.)</li> <li>Check the power control settings. (See page 28.)</li> <li>The unit's internal temperature has increased. Remove any objects blocking vent or clean.</li> </ul>
<ul style="list-style-type: none"> <li>No picture</li> </ul>	<ul style="list-style-type: none"> <li>Is connection to other components correct? (See pages 13 and 14.)</li> <li>Is correct input signal source selected after connection? (See page 29.)</li> <li>Is the correct input selected? (See page 29.)</li> <li>Is picture adjustment correct? (See pages 25 to 26.)</li> <li>Is "On" selected in "Audio Only"? (See page 36.)</li> <li>Is a non-compatible signal being input? (See page 14.)</li> </ul>
<ul style="list-style-type: none"> <li>No sound</li> </ul>	<ul style="list-style-type: none"> <li>Is the volume too low? (See page 18.)</li> <li>Is "Variable" selected in "Output Select"? (See page 36.)</li> <li>Have you pressed <b>MUTE</b> on the remote control unit? (See page 18.)</li> </ul>
<ul style="list-style-type: none"> <li>The TV sometimes makes a cracking sound.</li> </ul>	<ul style="list-style-type: none"> <li>This is not a malfunction. This happens when the cabinet slightly expands and contracts according to change in temperature. This does not affect the TV's performance.</li> </ul>

### Troubleshooting-Digital broadcasting

The error message about reception of broadcast

The example of an error message displayed on a screen	Error code	Possible Solution
<ul style="list-style-type: none"> <li>Failed to receive broadcast.</li> </ul>	<b>E202</b>	<ul style="list-style-type: none"> <li>Check the antenna cable. Check that the antenna is correctly setup.</li> </ul>
<ul style="list-style-type: none"> <li>No broadcast now.</li> </ul>	<b>E203</b>	<ul style="list-style-type: none"> <li>Check the broadcast time in the program guide.</li> </ul>

### Cautions regarding use in high and low temperature environments

- When the unit is used in a low temperature space (e.g. room, office), the picture may leave trails or appear slightly delayed. This is not a malfunction, and the unit will recover when the temperature returns to normal.
- Do not leave the unit in a hot or cold location. Also, do not leave the unit in a location exposed to direct sunlight or near a heater, as this may cause the cabinet to deform and the Liquid Crystal panel to malfunction.  
Storage temperature: -4°F to +140°F (-20°C to +60°C)

## Appendix

### Specifications

Item		Model: LC-46D43U	
LCD panel		46" Advanced Super View & BLACK TFT LCD	
Number of dots		3,147,264 dots (1366 × 768 × 3 dots)	
TV Function	TV-standard (CCIR)	American TV Standard ATSC/NTSC System	
	Receiving Channel	VHF/UHF	VHF 2-13ch, UHF 14-69ch
		CATV	1-135ch (non-scrambled channel only)
		Digital Terrestrial Broadcast (8VSB)	2-69ch
		Digital cable <sup>1</sup> (64/256 QAM)	1-135ch (non-scrambled channel only)
Audio multiplex	BTSC System		
Backlight		60,000 hours (at Backlight Standard position)	
Audio out		10W × 2	
Terminals	Rear	INPUT 1	AV in, COMPONENT in
		INPUT 2	AV in, COMPONENT in
		INPUT 3	S-VIDEO in, AV in
		INPUT 4	HDMI in with HDCP
		INPUT 5	Audio in, HDMI in with HDCP
		INPUT 6	15 pin mini D-sub, Audio in (Ø 3.5 mm jack)
		ANTENNA	75 Ω Unbalance, F Type × 1 for Analog (VHF/UHF/CATV) and Digital (AIR/CABLE)
		DIGITAL AUDIO OUTPUT	Optical Digital audio output × 1 (PCM/Dolby Digital)
		OUTPUT	Audio out
OSD language		English/French/Spanish	
Power Requirement		AC 120 V, 60 Hz (FOR NORTH AMERICA) AC 110-240 V, 50/60 Hz (FOR OTHERS)	
Power Consumption		270 W (0.7 W Standby with AC 120V)	
Weight	TV + stand	78.3 lbs./35.5 kg	
	TV only	68.3 lbs./31.0 kg	
Dimension <sup>2</sup> (W × H × D)	TV + stand	44 <sup>3</sup> / <sub>8</sub> × 31 <sup>9</sup> / <sub>64</sub> × 12 <sup>11</sup> / <sub>64</sub> inch	
	TV only	44 <sup>3</sup> / <sub>8</sub> × 28 <sup>43</sup> / <sub>64</sub> × 4 <sup>57</sup> / <sub>64</sub> inch	
Operating temperature		+ 32°F to + 104°F (0°C to + 40°C)	

<sup>1</sup> Emergency alert messages via Cable are unreceivable.

<sup>2</sup> The dimensional drawings are shown on the inside back cover.

- As part of policy of continuous improvement, SHARP reserves the right to make design and specification changes for product improvement without prior notice. The performance specification figures indicated are nominal values of production units. There may be some deviations from these values in individual units.

### Optional accessory

The listed optional accessory is available for the Liquid Crystal Television. Please purchase it at your nearest shop.

- Additional optional accessories may be available in the near future. When purchasing, please read the newest catalogue for compatibility and check the availability.

Part name	Model number
Wall mount bracket	AN-52AG1

## CLEARING THE SECRET NUMBER

If you forget the secret number, clear the secret number using the following procedure.

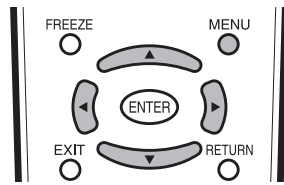

**1** Press **MENU** to display the MENU screen, and then press ◀▶ to select “Setup”.

**2** Press ▲/▼ to select “EZ Setup”, “CH Setup”, “Parental CTRL” or “Reset”, and the Secret number input screen displays.



**3** Press and hold both **CH▲** and **VOL+** on the TV simultaneously until the message appears on the screen.

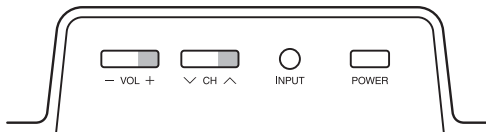

The secret number is

--	--	--	--

### NOTE

- As a precautionary measure, make a note of your secret number above, cut it from this manual, and keep it in a safe place.

### Information on the software license for this product

#### Software composition

The software included in this product is comprised of various software components whose individual copyrights are held by SHARP or by third parties.

#### Software developed by SHARP and open source software

The copyrights for the software components and various relevant documents included with this product that were developed or written by SHARP are owned by SHARP and are protected by the Copyright Act, international treaties, and other relevant laws. This product also makes use of freely distributed software and software components whose copyrights are held by third parties. These include software components covered by a GNU General Public License (hereafter GPL), a GNU Lesser General Public License (hereafter LGPL) or other license agreement.

#### Obtaining source code

Some of the open source software licensors require the distributor to provide the source code with the executable software components. GPL and LGPL include similar requirements. For information on obtaining the source code for the open source software and for obtaining the GPL, LGPL, and other license agreement information, visit the following website:

<http://www.sharpusa.com/gpl>

We are unable to answer any questions about the source code for the open source software. The source code for the software components whose copyrights are held by SHARP is not distributed.

#### Acknowledgements

The following open source software components are included in this product:

- linux kernel
- busybox
- uClibc
- zlib
- libpng
- libjpeg



# Calling for Service

For location of the nearest Sharp Authorized Service, or to obtain product literature, accessories, supplies, or customer assistance, please call 1-800-BE-SHARP.

## LIMITED WARRANTY

### CONSUMER LIMITED WARRANTY

SHARP ELECTRONICS CORPORATION warrants to the first consumer purchaser that this Sharp brand product (the "Product"), when shipped in its original container, will be free from defective workmanship and materials, and agrees that it will, at its option, either repair the defect or replace the defective Product or part thereof with a new or remanufactured equivalent at no charge to the purchaser for parts or labor for the period(s) set forth below.

This warranty does not apply to any appearance items of the Product nor to the additional excluded item(s) set forth below nor to any Product the exterior of which has been damaged or defaced, which has been subjected to improper voltage or other misuse, abnormal service or handling, or which has been altered or modified in design or construction.

In order to enforce the rights under this limited warranty, the purchaser should follow the steps set forth below and provide proof of purchase to the servicer.

The limited warranty described herein is in addition to whatever implied warranties may be granted to purchasers by law. ALL IMPLIED WARRANTIES INCLUDING THE WARRANTIES OF MERCHANTABILITY AND FITNESS FOR USE ARE LIMITED TO THE PERIOD(S) FROM THE DATE OF PURCHASE SET FORTH BELOW. Some states do not allow limitations on how long an implied warranty lasts, so the above limitation may not apply to you.

Neither the sales personnel of the seller nor any other person is authorized to make any warranties other than those described herein, or to extend the duration of any warranties beyond the time period described herein on behalf of Sharp.

The warranties described herein shall be the sole and exclusive warranties granted by Sharp and shall be the sole and exclusive remedy available to the purchaser. Correction of defects, in the manner and for the period of time described herein, shall constitute complete fulfillment of all liabilities and responsibilities of Sharp to the purchaser with respect to the Product, and shall constitute full satisfaction of all claims, whether based on contract, negligence, strict liability or otherwise. In no event shall Sharp be liable, or in any way responsible, for any damages or defects in the Product which were caused by repairs or attempted repairs performed by anyone other than an authorized servicer. Nor shall Sharp be liable or in any way responsible for any incidental or consequential economic or property damage. Some states do not allow the exclusion of incidental or consequential damages, so the above exclusion may not apply to you.

THIS WARRANTY GIVES YOU SPECIFIC LEGAL RIGHTS. YOU MAY ALSO HAVE OTHER RIGHTS WHICH VARY FROM STATE TO STATE.

### Model Specific Section

**Your Product Model Number & Description:**

LC-46D43U LCD Color Television  
(Be sure to have this information available when you need service for your Product.)

**Warranty Period for this Product:**

One (1) year parts and labor from the date of purchase.

**Additional Item(s) Excluded from Warranty Coverage (if any):**

Non-rechargeable batteries.

**Where to Obtain Service:**

From a Sharp Authorized Servicer located in the United States. To find the location of the nearest Sharp Authorized Servicer, call Sharp toll free at 1-800-BE-SHARP.

**What to do to Obtain Service:**

Contact your Sharp Authorized Servicer to obtain in-home service for this Product. The Servicer will come to your home and if it is necessary to remove the Product, the Servicer will reinstall it. Be sure to have **Proof of Purchase** available.

TO OBTAIN PRODUCT INFORMATION, CALL 1-800-BE-SHARP OR VISIT [www.sharpusa.com](http://www.sharpusa.com)

# SHARP®

SHARP ELECTRONICS CORPORATION

Sharp Plaza, Mahwah, New Jersey 07430-2135

SHARP CORPORATION

# SHARP®

## LIMITED WARRANTY

### Consumer Electronics Products

### Congratulations on your purchase!

Sharp Electronics of Canada Ltd. (hereinafter called "Sharp") gives the following express warranty to the first consumer purchaser for this Sharp brand product, when shipped in its original container and sold or distributed in Canada by Sharp or by an Authorized Sharp Dealer:

Sharp warrants that this product is free, under normal use and maintenance, from any defects in material and workmanship. If any such defects should be found in this product within the applicable warranty period, Sharp shall, at its option, repair or replace the product as specified herein.

This warranty shall not apply to:

- (a) Any defects caused or repairs required as a result of abusive operation, negligence, accident, improper installation or inappropriate use as outlined in the owner's manual.
- (b) Any Sharp product tampered with, modified, adjusted or repaired by any party other than Sharp, Sharp's Authorized Service Centres or Sharp's Authorized Servicing Dealers.
- (c) Damage caused or repairs required as a result of the use with items not specified or approved by Sharp, including but not limited to head cleaning tapes and chemical cleaning agents.
- (d) Any replacement of accessories, glassware, consumable or peripheral items required through normal use of the product including but not limited to earphones, remote controls, AC adapters, batteries, temperature probe, stylus, trays, filters, belts, ribbons, cables and paper.
- (e) Any cosmetic damage to the surface or exterior that has been defaced or caused by normal wear and tear.
- (f) Any damage caused by external or environmental conditions, including but not limited to transmission line/power line voltage or liquid spillage.
- (g) Any product received without appropriate model, serial number and CSA/cUL markings.
- (h) Any products used for rental or commercial purposes.
- (i) Any installation, setup and/or programming charges.

Should this Sharp product fail to operate during the warranty period, warranty service may be obtained upon delivery of the Sharp product together with proof of purchase and a copy of this LIMITED WARRANTY statement to an Authorized Sharp Service Centre or an Authorized Sharp Servicing Dealer. In home warranty service may be provided at Sharp's discretion on any Sharp television with the screen size of 27" or larger and on any Sharp Over-the-Range Microwave Oven.

This warranty constitutes the entire express warranty granted by Sharp and no other dealer, service centre or their agent or employee is authorized to extend, enlarge or transfer this warranty on behalf of Sharp. To the extent the law permits, Sharp disclaims any and all liability for direct or indirect damages or losses or for any incidental, special or consequential damages or loss of profits resulting from a defect in material or workmanship relating to the product, including damages for the loss of time or use of this Sharp product or the loss of information. The purchaser will be responsible for any removal, reinstallation, transportation and insurance costs incurred. Correction of defects, in the manner and period of time described herein, constitute complete fulfillment of all obligations and responsibilities of Sharp to the purchaser with respect to the product and shall constitute full satisfaction of all claims, whether based on contract, negligence, strict liability or otherwise.

**WARRANTY PERIODS:**

	Parts & Labour (exceptions noted)
Audio Product	1 year
Camcorder	1 year
DVD Product	1 year
Projector	1 year (lamp 90 days)
LCD TV	1 year
Microwave Oven	1 year (magnetron component-4 additional years)
Air Purifier	1 year
Portable Air Conditioner	1 year

To obtain the name and address of the nearest Authorized Sharp Service Centre or Dealer, please contact:  
SHARP ELECTRONICS OF CANADA LTD. 335 Britannia Road East, Mississauga, Ontario L4Z 1W9

For more information on this Warranty, Sharp Extended Warranty Offers, Sharp Canada Products, Accessory Sales, Dealer or Service Locations, please call (905) 568-7140  
Visit our Web site: [www.sharp.ca](http://www.sharp.ca)



# Dimensional drawings

Unit: inch (mm)

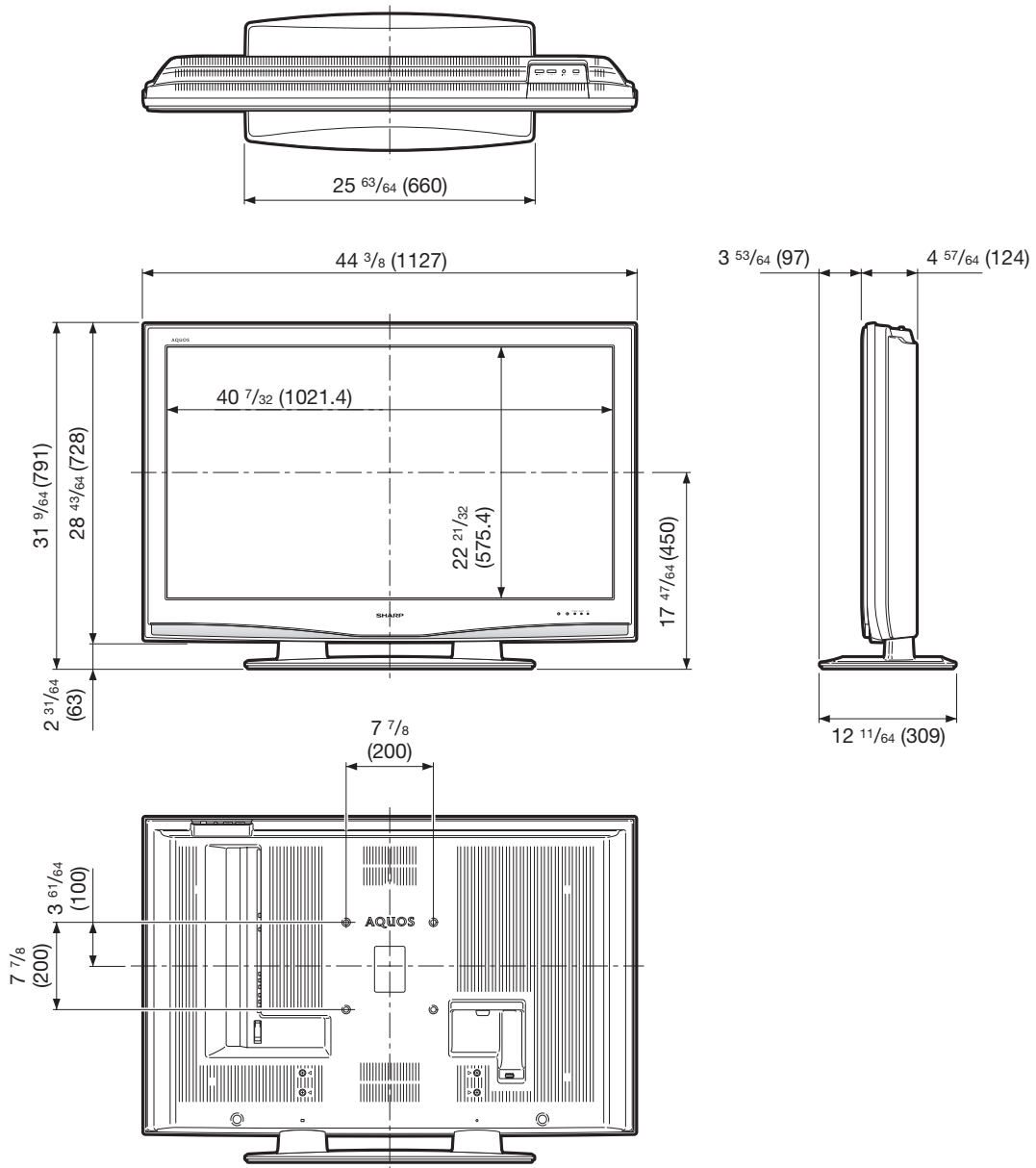

**SHARP®**

**SHARP ELECTRONICS CORPORATION**

Sharp Plaza, Mahwah, New Jersey 07430-2135

**SHARP CORPORATION**

Printed in Mexico  
Imprimé au Mexique  
Impreso en México  
Impresso no México  
TINS-D067WJZZ  
07P04-MX-NM