

40" HD Widescreen LCD Television
TLA-04011C and 4011-TLXB



©2007 by  Polaroid All rights reserved.

“Polaroid” and “Polaroid and Pixel” are trademarks of Polaroid Corporation, Waltham, MA, USA. Changes are periodically made to this document. Changes, technical inaccuracies, and typographic errors will be corrected in subsequent editions. For service, support and warranty information, visit www.polaroid.com.



This product contains electrical or electronic materials. The presence of these materials may, if not disposed of properly, have potential adverse effects on the environment and human health. Presence of this label on the product means it should not be disposed of as unsorted waste and must be collected separately. As a consumer, you are responsible for ensuring that this product is disposed of properly. To find out how to properly dispose of this product, please go to www.polaroid.com and click on “Company” or call the customer service number for your country listed in the instruction manual.



Manufactured under license from Dolby Laboratories.
“Dolby” and the double-D symbol are trademarks of Dolby Laboratories.
Confidential unpublished works. © 1992 -1997 Dolby Laboratories, Inc. All rights reserved.



This TV incorporates High-Definition Multimedia Interface (HDMI™) technology. HDMI, the HDMI logo and High-Definition Multimedia Interface are trademarks or registered trademarks of HDMI Licensing LLC.

Federal Communications Commission Statement



ENGLISH

This equipment has been tested and found to comply with the limits of a class B digital device, pursuant to Part 15 of the FCC Rules. These limits are designed to provide reasonable protection against harmful interference in a residential installation. This equipment generates, uses and can radiate radio frequency energy and, if not installed and used in accordance with the instructions, may cause harmful interference to radio communications. However, there is no guarantee that interference will not occur in a particular installation. If this equipment does cause harmful interference to radio or television reception, which can be determined by turning the equipment off and on, the user is encouraged to try to correct the interference by one or more of the following measures:

1. Reorient/Relocate the receiving antenna.
2. Increase the separation between the equipment and receiver.
3. Connect the equipment into an outlet on a circuit which is different from what the receiver is connected to.
4. Consult the dealer or an experienced radio/TV technician for help.



Changes or modifications not expressly approved by the manufacturer responsible for compliance could void the user authority to operate the equipment.

Warnings and Precautions

To prevent any injuries, the following safety precautions should be observed in the installation, use, servicing and maintenance of this equipment.

Before operating this equipment, please read this manual completely, and keep it nearby for future reference.



WARNING

This symbol is intended to alert the user to avoid the risk of electric shock. This equipment must not be disassembled by anyone except qualified service personnel.



CAUTION

This symbol is intended to alert the user to the presence of important operating and maintenance instructions in the literature accompanying the appliance.



To reduce the risk of fire or electric shock, do not expose this equipment to rain or moisture.

- TO REDUCE THE RISK OF ELECTRIC SHOCK,
- DO NOT REMOVE COVER (OR BACK).
- NO USER-SERVICEABLE PARTS INSIDE.
- REFER SERVICING TO QUALIFIED SERVICE PERSONNEL.



Use of controls, adjustments or performance of procedures other than those specified herein may result in hazardous radiation exposure.

Important Safety Instructions



This symbol indicates caution points.



This symbol indicates actions that should not be done.



This symbol indicates actions that must be performed.



- Do not place the equipment on any uneven or unstable carts, stands, tables, shelves etc. The equipment may fall, causing serious injury to children or adults and serious damage to the equipment itself.



- Use only a cart or stand recommended by the manufacturer. This equipment and recommended cart or stand should be handled with care. Quick stops, excessive force, and uneven surfaces may cause the equipment and cart/stand to overturn.



- Do not disable the 3-wire grounding type plug. The grounding pin on the 3-prong plug is an important feature. Removing the grounding pin will increase the risk of damaging the equipment.
- If you can not fit the plug into the electrical outlet, contact an electrician to install a grounding outlet.
- Always operate this equipment from the type of power source indicated on the rear of the serial/model plate.
- Never overload wall outlets and extensions.



- Use and handle the power cord with care. Do not place any heavy objects on the AC power cord.
- Do not pull the AC power cord. Do not handle the AC power cord with a wet hand.
- Do not touch the power cord and antenna cable during lightning.
- Remove the plug from the wall outlet, if the equipment will not be used for a long period of time.
- Do not place, use or handle this equipment near water.
- Never expose the equipment to liquid, rain, or moisture.
Seek for service if any of the above is spilled into the equipment.
- Do not expose the equipment to extreme temperature or to direct sunlight, as the equipment may heat up and suffer damage.
- Do not install the equipment near any heat sources such as radiators, heat registers, stoves, or any other apparatus that might produce heat.
- Do not attempt to service the equipment yourself.
- Opening and removing the covers may expose you to dangerous voltage or other hazards and may void your warranty. Refer service to qualified personnel.
- Do not place or drop any other objects on top.
- Do not insert anything into the ventilation holes of your equipment.
Inserting any metal or flammable objects may result to fire or electric shock.
- Protect the power cord from being walked on or pinched particularly at plugs, convenience receptacles, and the point where they exit from the apparatus.
- Do not place the equipment on uneven or unstable carts, stands, tables, shelves etc. The equipment may fall, causing serious injury to children or adults and serious damage to the equipment itself.
Always place the equipment on the floor or on a surface that is sturdy, level, stable and strong enough to support the weight of the equipment.
- Do not block any ventilating openings. Leave an open space around the equipment.
Never place the equipment :
on a bed, sofa, rug, or any other similar surfaces; too close to drapes/curtains/walls, in a bookcase, built-in cabinet, or any other similar places that may cause poor ventilation.
- Unplug this apparatus during lightning storms or when unused for long periods of time.
- Refer all servicing to qualified service personnel. Servicing is required when the apparatus has been damaged in any way, such as power-supply cord or plug is damaged, liquid has been spilled or objects have fallen into the apparatus, the apparatus has been exposed to rain or moisture, does not operate normally, or has been dropped.



- Always remove the power cord from the outlet before cleaning the equipment.
- Never use liquid or aerosol cleaners on the equipment.
Clean only with a soft dry cloth.



- Only use attachments/accessories specified by the manufacturer.

Antenna Safety Instructions

If an outdoor antenna is connected, follow the precautions below:



- An outdoor antenna should not be located in any area where it could come in contact with overhead power lines, or any other electric light or power circuits.
- When installing an outdoor antenna system, extreme caution should be taken to prevent contact with power lines. Direct contact with power lines may be fatal and should be avoided at all costs.

Section 810 of National Electrical Code (NEC) provides information with respect to proper grounding of the mast and supporting structure, grounding of the lead-in wire to an antenna discharge unit, size of grounding conductors, location of antenna discharge unit, connection to grounding electrodes, and requirements for the grounding electrode.

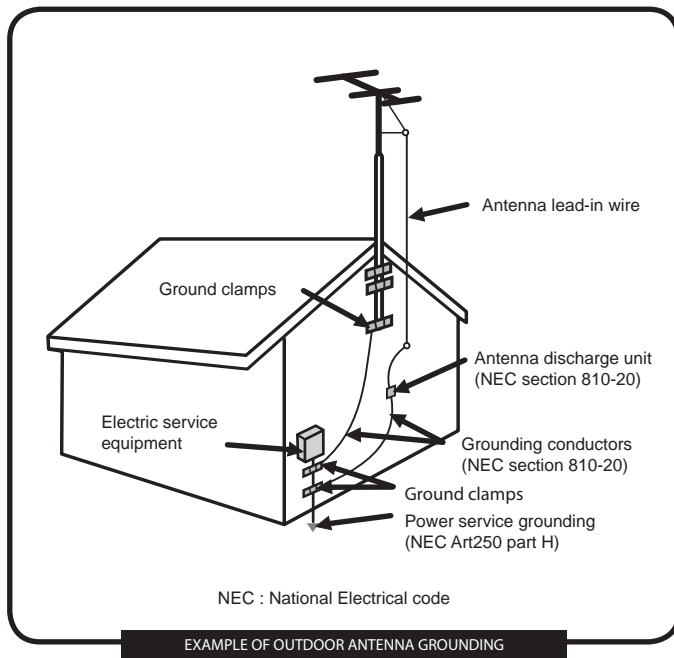

TABLE OF CONTENTS



- **Federal Communications Commission Statement** 1

- **Warnings and Precautions**
 - Important Safety Instructions 2
 - Antenna Safety Instructions 4

- **Chapter 1 Introducing the LCD TV**
 - Key Features 6
 - Package Contents 7
 - Setting Your LCD TV 8
 - Your LCD TV 11
 - Your Remote Control 13

- **Chapter 2 Installing the LCD TV**
 - Connecting a TV Cable or an Antenna 15
 - Connecting a VCR 20
 - Connecting a Video Camera or Game Console 21
 - Connecting a DVD Player 22
 - Connecting a Digital TV Cable Box or Digital Satellite Receiver 24
 - Connecting an AV Equipment with HDMI Connector 25
 - Connecting an AV Equipment with DVI Connector 26
 - Connecting a PC 27
 - Connecting an Audio Receiver or a Dolby Digital 5.1 Sound System 28

- **Chapter 3 USING THE FEATURES**
 - Wide Screen Viewing 29
 - Operating the Menu 30
 - Customizing the VIDEO Settings 32
 - Customizing the AUDIO Settings 34
 - Customizing the TV Settings 36
 - Customizing the SETUP Settings 38
 - Using the Program Block Settings 41
 - Using the Program Guide 46

- **Specifications** 47

- **Programming your Remote Control** 48

Chapter 1

Introducing the LCD TV

Key Features

Various Audio/Video terminals for external equipment connection

- 2 sets of composite A/V input terminals
- 1 set of S-VIDEO terminals
- 2 sets of component Video input terminals
- 1 VGA/ Audio input terminals
- 2 HDMI/Audio input terminals
- 1 set of Audio(L/R) output terminals
- 2 SPDIF output terminals (Optical x 1 /Coaxial x 1)
- 1 Headphone terminal

The built-in TV tuner to receive HD ATSC

- This function allows the reception of HD broadcasting without the addition of a set top box.

High Definition Multimedia Interface (HDMI)

- High Definition Multimedia Interface (HDMI) is a small, user-friendly interconnect that can carry up to 5 Gbps of combined video and audio in a single cable. This system eliminates the cost, complexity and confusion of multiple cables used to connect current A/V systems.

HDTV Component Video Inputs

- Offers the best video quality for DVD (1080i, 720p) and digital set-top-box (1080i, 720p) connections.

3D Digital Noise Reduction

- This function can digitally reduce image noise to provide better picture quality.

Film-Mode Detection (3:2 Reverse Pull Down)

- This function can automatically detect content derived from film and adjust the interlacer's frame matching to provide a more natural-looking, clearer image of the moving picture.

Package Contents

Make sure all of the following contents are included.

- LCD TV



- Bottom Stand /
Screw Driver and Screws

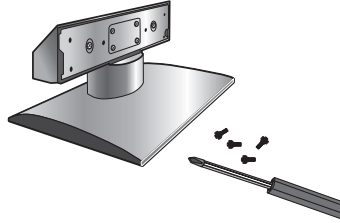

- Remote Control/
AAA Batteries x 2



- VIDEO Cable



- Component Cable

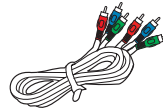

- Power Cord



- AUDIO Cable



- Warranty Card

- User's Manual

- Quick Start Guide

- Stand Assembly Guide

- Remote control Guide

These items are all you need to set up and operate the LCD TV in its basic configuration.



Make sure all of the above contents are included in the package. If you are missing any items, please contact the Polaroid customer service department.

Setting Up Your LCD TV

How to install the TV Stand

Read all instructions before continuing with the stand installation.



Attach the Stand the TV with the bottom foam packaging material still attached.

- Lift foam packaging material from the top of the LCD out of the box.
- Lift LCD out of the box, with the bottom foam packaging material still attached, and place onto a stable surface.

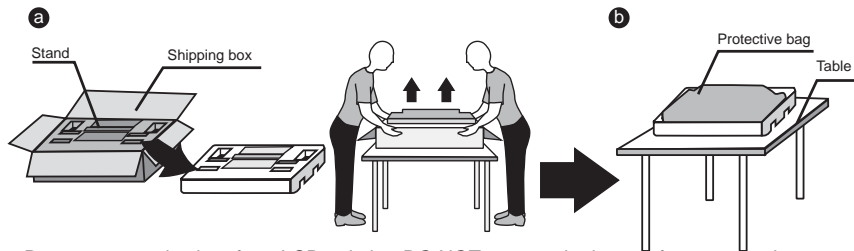

- Remove protective bag from LCD unit, but DO NOT remove the bottom foam packaging material from the TV.
- Locate the place on the back of the TV to attach the stand. Secure the stand to the LCD with all four screws.

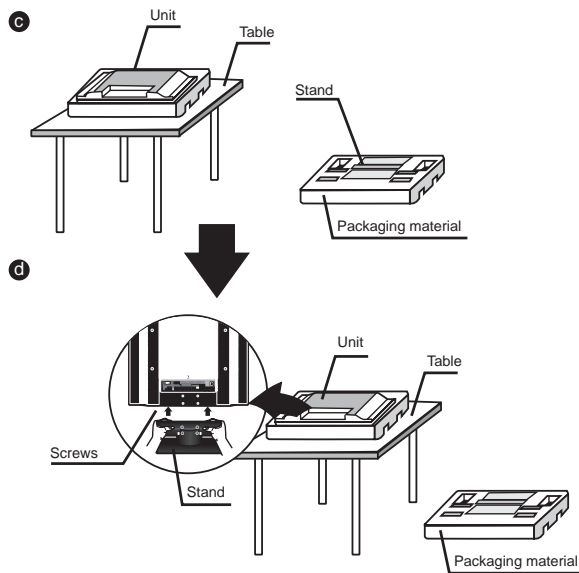

How to remove the TV Stand

If you prefer to mount your new Polaroid TV on a wall instead of attaching it to the stand, please reference the instructions included in the wall mounting kit (sold separately).



Verify your TV's model and be sure to use the wall mounting kit specified for your TV model only. Contact a qualified technician for assistance when installing the wall mounting kit.

1

To prevent damaging the surface of the LCD TV, place the TV on a soft cloth.

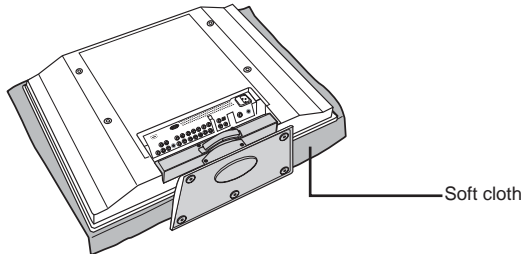

2

Remove the screws of the table stand and detach the table stand from the TV.

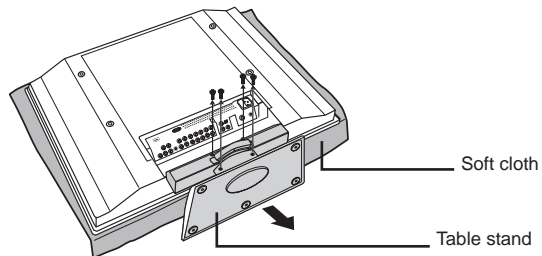

3

Align the holes on the wall mounting hook units with the corresponding holes on the rear of the TV and fasten four screws.

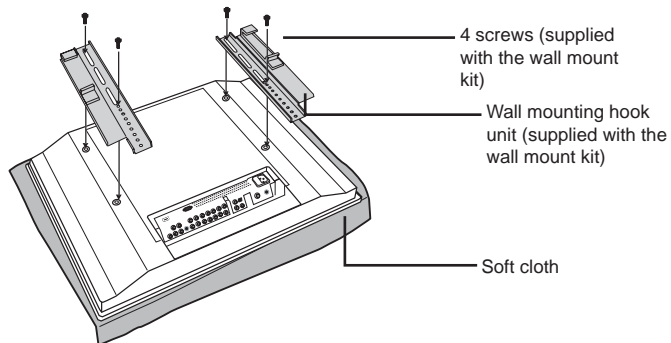

How to setup the TV

- 1 Use a supplied antenna cable to connect the VHF/UHF signal to the LCD TV's ANT. terminal (refer to page15-17).
- 2 Connect the AC power cord at the back of the TV and connect the power cord to wall outlet.
- 3 Insert the 2 batteries supplied in remote control.

Step1 Slide the back cover up to open the battery compartment of the remote control.

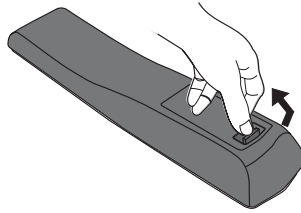

Step2 Insert two AAA size batteries. Make sure to match the (+) and (-) ends of the batteries with the (+) and (-) ends indicated in the battery compartment. Slide the cover back into place.

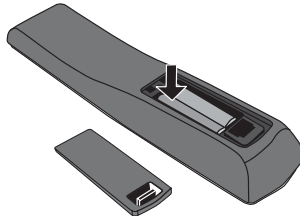

Do not use caustic cleaners (porcelain, stainless steel, toilet, or oven cleaner etc.) on the remote, as it may suffer damage.

- 4 Connect other an external AV device (refer to page19-27).

Your LCD TV

Front/Right Side View and Controls

ENGLISH

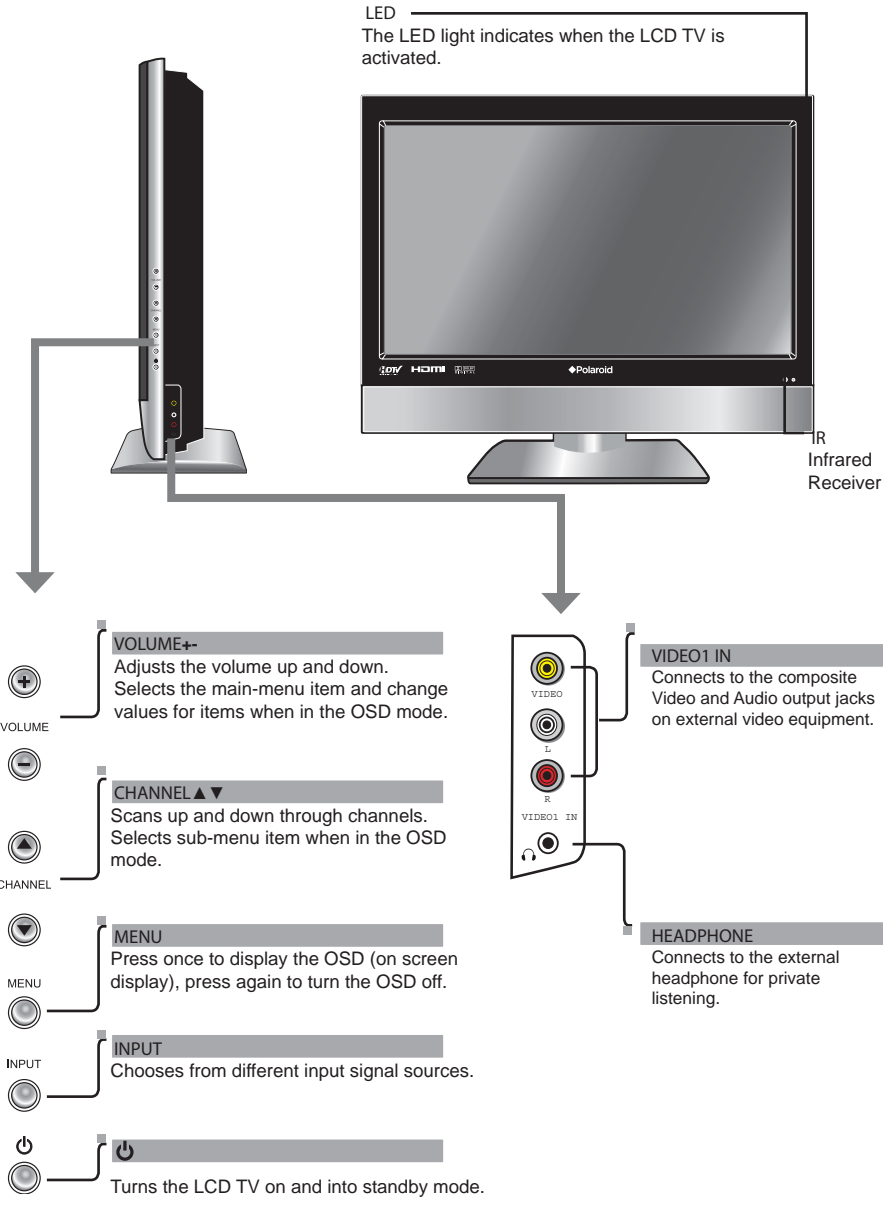

Rear View and Jacks

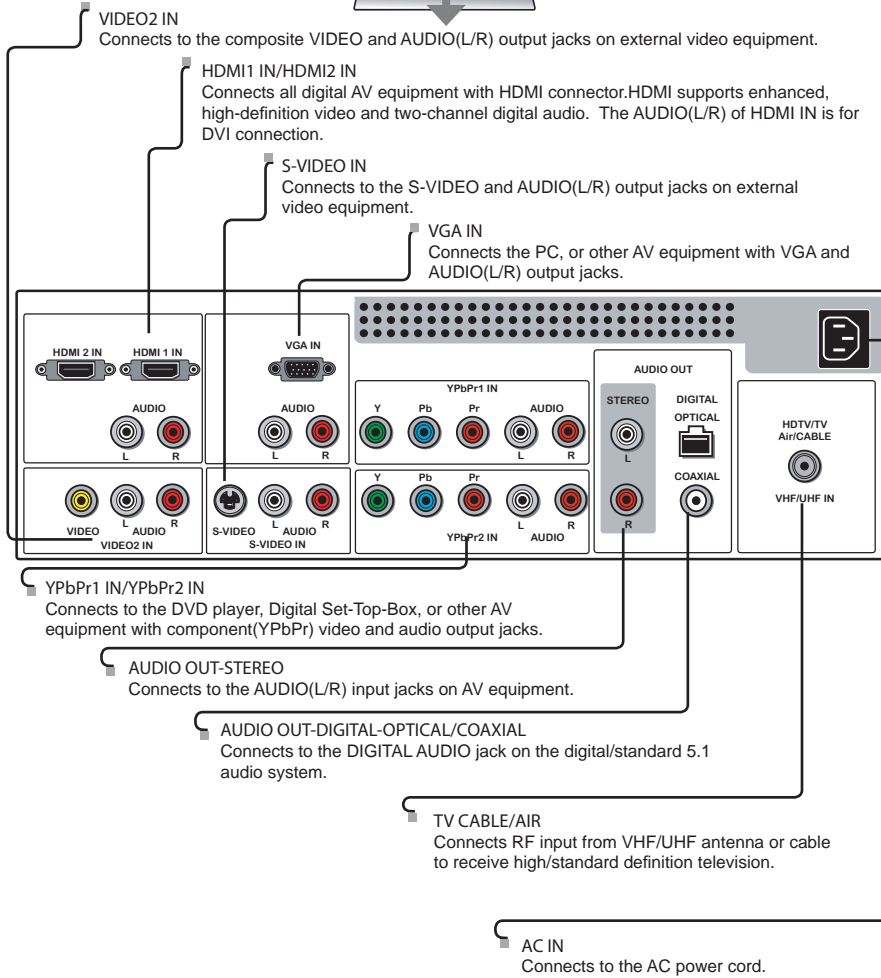
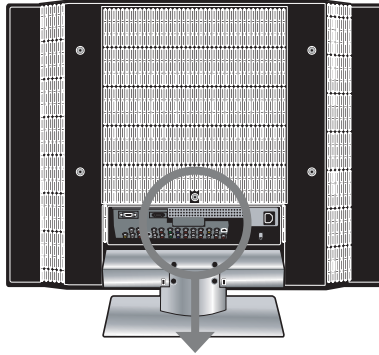

Your Remote Control

This package includes a Polaroid remote that enables control of up to four devices. To select a device, simply select one of the following device mode controls: TV, CBL/SAT, DVD/VCR, or AUDIO.

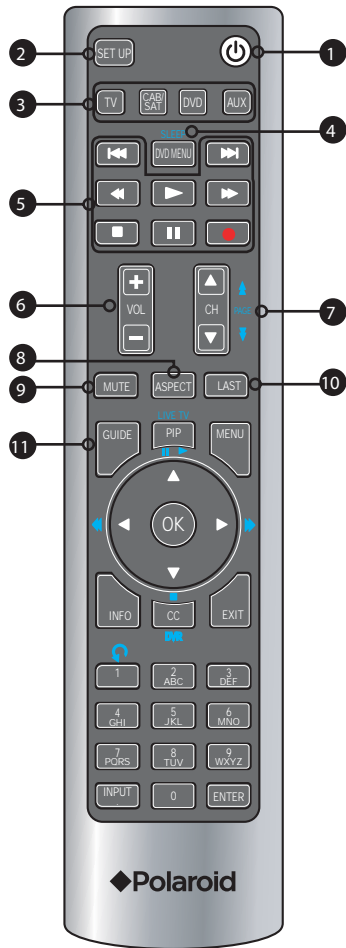

1		Turns the LCD TV on and off
2	SET UP	Remote control universal code setup. For more information on setting up your remote control, please see the "Programming Your Remote Control" section (refer to page 47)
3	TV CAB/SAT DVD AUX	Controls this LCD TV Controls Cable Converter or Satellite Receiver Controls DVD player or Video player Controls Audio Amplifier
4	SLEEP	Cycles through the LCD TV sleep time: OFF/30/60/90/120 mins
5		Other device function keys
6	VOL+/-	Increases and decreases volume
7	CH▲▼	Change channel up and down
8	ASPECT	Cycles through Wide mode settings: NORMAL/FULLWIDE/ZOOM
9	MUTE	Pressing once mutes audio. Pressing again restores audio
10	LAST	Returns to previously selected channel
11	GUIDE	In TV mode, pressing GUIDE displays the Program Guide on the screen

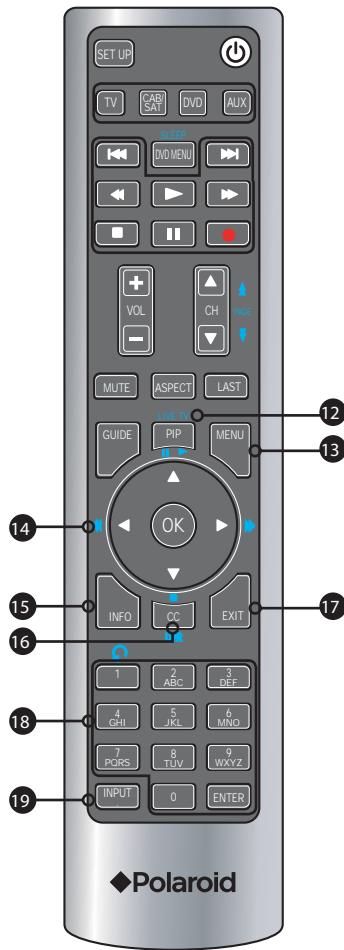

- 12 PIP PIP function is not available. Only for other devices function.

- 13 MENU Displays the OSD menu on the screen.

- 14 ◀▶▲▼,OK Cycles through OSD options and selects individual menu items. OK confirms option settings

- OK In TV mode, pressing OK to display a channel list

- 15 INFO Displays information on the LCD TV screen such as input source, channel, program title.

- 16 CC Cycles through the Closed Caption:
 - Analog Closed Caption: OFF/CC1/CC2/CC3/CC4/Text1/Text2/Text3/Test4
 - Digital Closed Caption: Service1/Service2/Service3/Service4/Service5/Service6/OFF

- 17 EXIT Exits the OSD menu

- 18 0-9/ENTER Pressing a number selects a channel. Following selection, pressing ENTER activates the channel, or channel activates automatically in 3 seconds

- 19 INPUT Pressing INPUT to display a source list, use ▲▼ buttons to select the video equipment connected to the video inputs of your LCD TV: TV/VIDEO1/VIDEO2/VIDEO3/VIDEO4/VIDEO5/VIDEO6/VIDEO7/COMPUTER
 - In TV mode, use with 0-9 and ENTER buttons to select a digital channels



Effective range:
The remote can control the LCD TV from up to 5m away, if pointed directly at the receiver.

Chapter 2

Installing the LCD TV

Refer to the owner's manual of any external equipment to be connected.
When connecting any external equipment, do not connect any AC power cords to wall outlets until all other connections are completed.

ENGLISH

Connecting a TV Cable or an Antenna

Antenna Connection

The antenna requirements for good color TV reception are more important than those for a black & white TV reception. For this reason, a good quality outdoor antenna is strongly recommended. The following is a brief explanation of the type of connection that is provided with the various antenna systems.

- A 75-ohm system is generally a round cable (not included) with F-type connector that can easily be attached to a terminal without tools.

F-type connector



75-ohm coaxial cable (round)

- A 300-ohm system is a flat twin-lead cable (not included) that can be attached to a 75-ohm terminal through a 300-75-ohm adapter (not included).



300-ohm twin-lead cable (flat)

Use one of the following two diagrams when connecting an outdoor antenna.

A: Shows how to use a VHF/UHF combination outdoor antenna.

B: Shows how to use a separate VHF and/or UHF outdoor antenna.

A. Combination VHF/UHF antenna

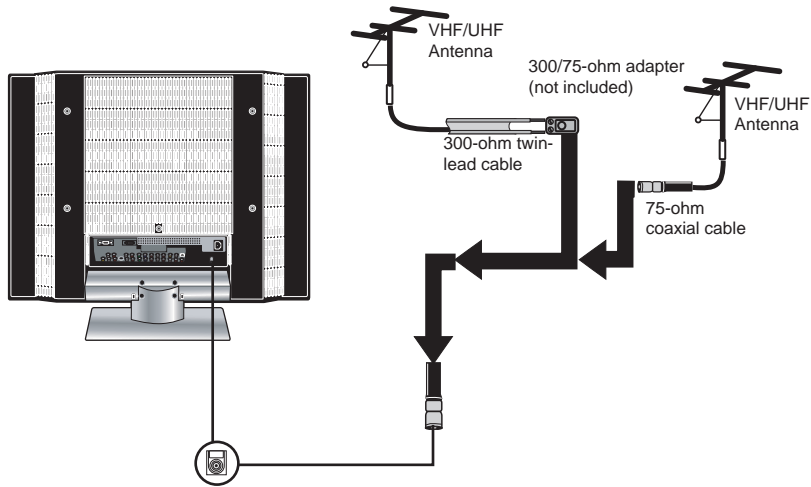

B. Separate VHF and/or UHF antennas

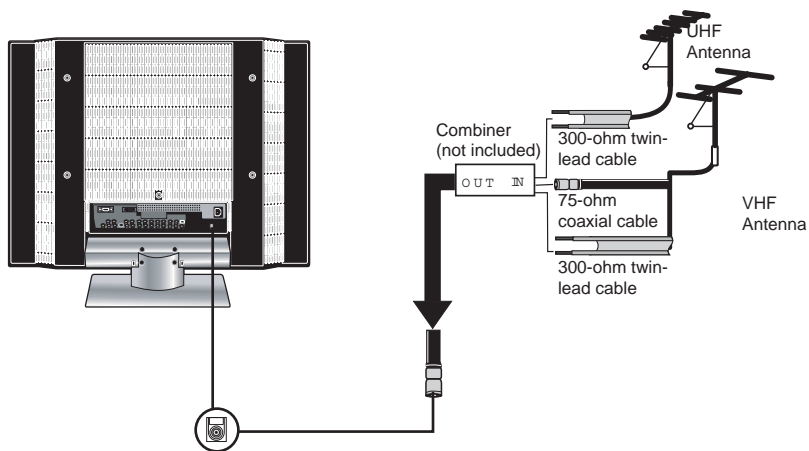

Cable TV (CATV) Connection

This reminder is provided to call the CATV system installer's attention to Article 820-40 of the National Electrical Code (NEC) that provides guidelines for proper grounding and, in particular, specifies that the cable ground shall be connected to the grounding system of the building accurately, or as close to the point of cable entry as possible. Use of this TV for other than private viewing of programs broadcasted on UHF, VHF or transmitted by cable companies for the use of the general public may require authorization from the broadcast/cable company, and/or program owner.

- A 75-ohm coaxial cable connector is built into the set for easy hookup. When connecting the 75-ohm coaxial cable to the set, connect the 75-ohm cable into the ANT. terminal.
- Some cable TV companies offer premium pay channels. Since the signals of these premium pay channels are scrambled, a cable TV converter/descrambler is generally provided to the subscriber by the cable TV company.

This converter/descrambler is necessary for normal viewing of scrambled channels. (Set your TV to channel 3 or 4, typically one of these channels is used. If this is unknown, consult your cable TV company.)

For more specific instructions on installing cable TV, consult your cable TV company. One possible method of connecting the converter/descrambler provided by your cable TV company is shown in the diagram below.

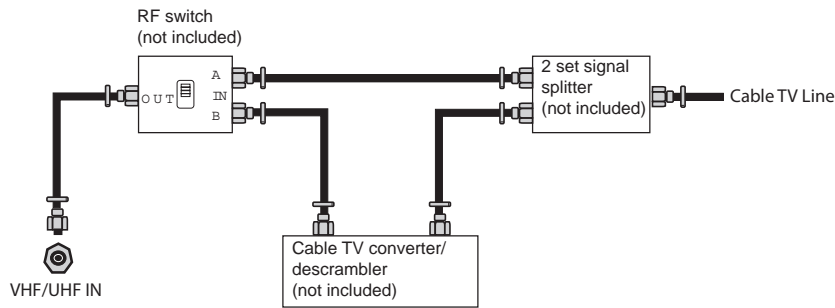

- ⚠ The RF switch (not included) is required to provide two inputs (A and B). Setting the RF switch to position A allows viewing of all unscrambled channels by using the TV channel keys.
- Setting the RF switch to position B allows viewing of all scrambled channels via the converter/descrambler by using the converter channel keys.

- 1 Use a supplied antenna cable to connect the TV signal to the LCD TV's TV CABLE terminal.

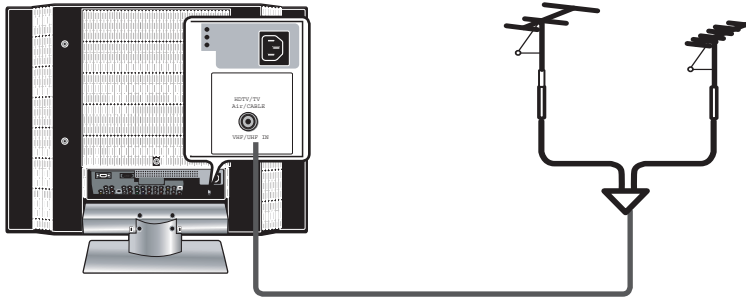

- 2 Connect the AC power cord at the back of the TV and connect the power cord to wall outlet.

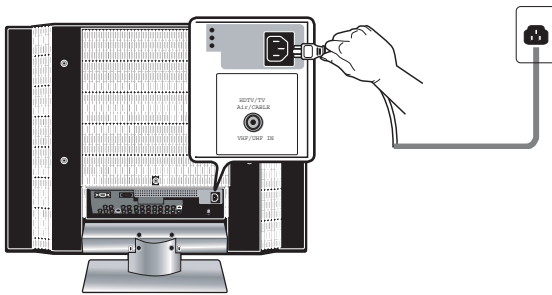

This TV is equipped with a safety fuse. In the event of an electrical storm or power outage the safety fuse is designed to protect your TV. If your TV has no power, check the fuse by prying the cover off, following the illustration below. If the fuse is blown, visit your local hardware store and ask for a 4A 250V - 5x20mm Time Lag Fuse (Slow Blow) to replace the fuse.



! BE SURE TO UNPLUG AC POWER CORD BEFORE REMOVING THE FUSE.

- 3 Press the  button on the remote to turn on the LCD TV.

! Always disconnect the LCD TV from the main voltage when the LCD TV will not be used for a long period of time. The POWER button on the front panel is only used for switching the LCD TV into standby, it does not disconnect the device from the main voltage. To completely disconnect the main voltage, please remove the power plug from the socket.

- 3 Press the **⏻** button on the remote to turn on the LCD TV. (Scroll down using the UP/DOWN buttons to see Computer-VGA option)

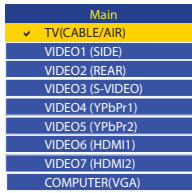

- 4 Press the **INPUT** button on the remote to display the Input List. Use the **▲▼** buttons to select TV (Cable/Air) and press the **OK** button.

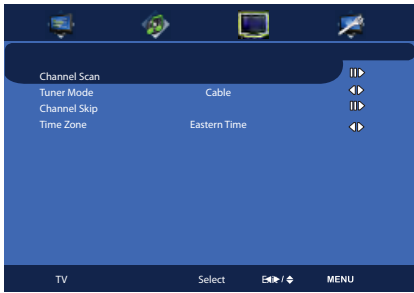

- 5 Press the **MENU** button on the remote control to display the Main menu, and use the **◀▶** buttons to select the TV icon.



! The Channel Scanning will create a list of receivable channels for the current input (antenna or cable). You will be required to run Channel Scanning for each RF input to create a list of available channels from both inputs.

- 7 Press the **OK** button to display the received channel list, then press **▲▼** to select a channel. Use the ***** (**INPUT** button) with 0-9 buttons to select digital channel (for example 9.1)

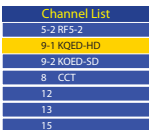

! The digital main channel might include many subchannels (for example 9-1, 9-2..) that are showing program at the same time.

Connecting a VCR

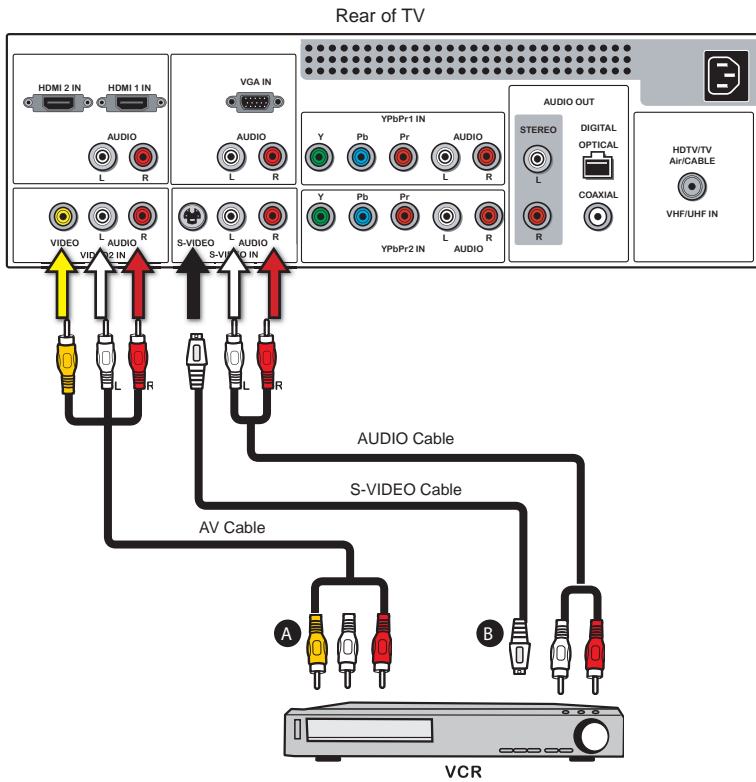

1

METHOD A:

Use a composite cable to connect the VCR's composite video/audio jacks to the LCD TV's VIDEO2 IN jacks.

METHOD B:

Use an audio cable to connect the VCR's audio output jacks to the LCD TV's audio inputs. Use a S-Video cable to connect the VCR's s-video output jack to the LCD TV's S-VIDEO IN input jack.

2

Connect all AC power sources, before turning on the power switch of the LCD TV or other connected equipment.

3

Press the  button on the remote to turn on the LCD TV.

4

To watch a videotape, press the INPUT button on the remote to select VIDEO2 (METHOD A), or VIDEO3 (METHOD B).

Connecting a Video Camera or Game console

ENGLISH

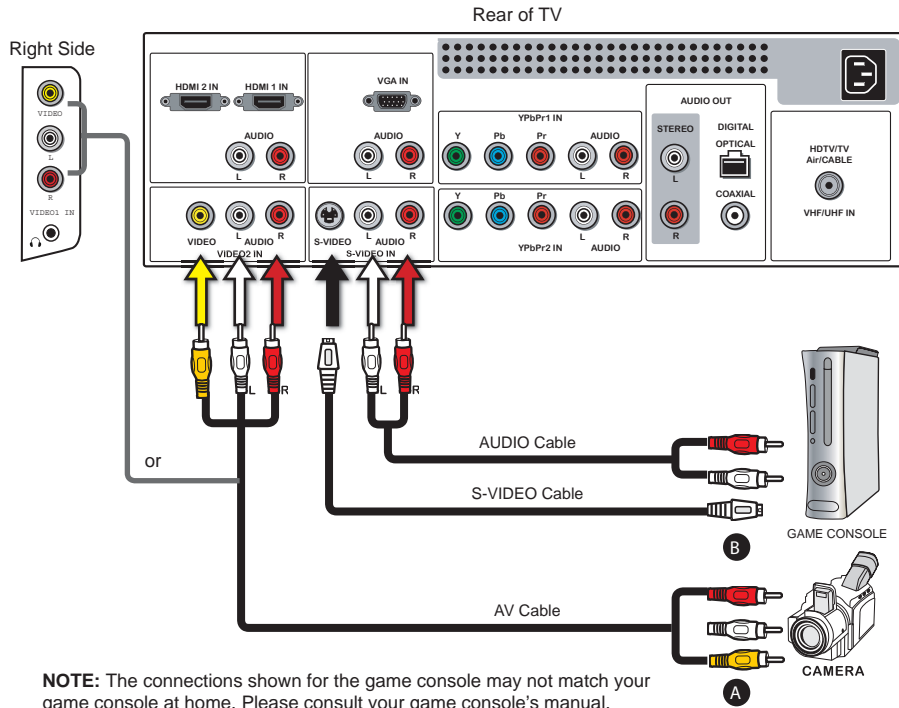

NOTE: The connections shown for the game console may not match your game console at home. Please consult your game console's manual.

1

METHOD A:

Use a composite cable to connect the video camera's or game console's composite video/audio jacks to the LCD TV's VIDEO2 IN jacks or VIDEO1 IN jacks.

METHOD B:

Use an audio cable to connect the video camera's or game console's audio output jacks to the LCD TV's audio inputs. Use an S-Video cable to connect the video camera's or game console's s-video output jack to the LCD TV's S-VIDEO IN input jack.

2

Connect all AC power sources, before turning on the power switch of the LCD TV or other connected equipment.

3

Press the  button on the remote to turn on the LCD TV.

4

To watch a video vis camera or game console, press the INPUT button on the remote to select VIDEO2/VIDEO1(METHOD A), or VIDEO3 (METHOD B).



Not all cameras have the ability to connect to a TV. Please check your video camera user guide for compatibility.

Connecting a DVD Player

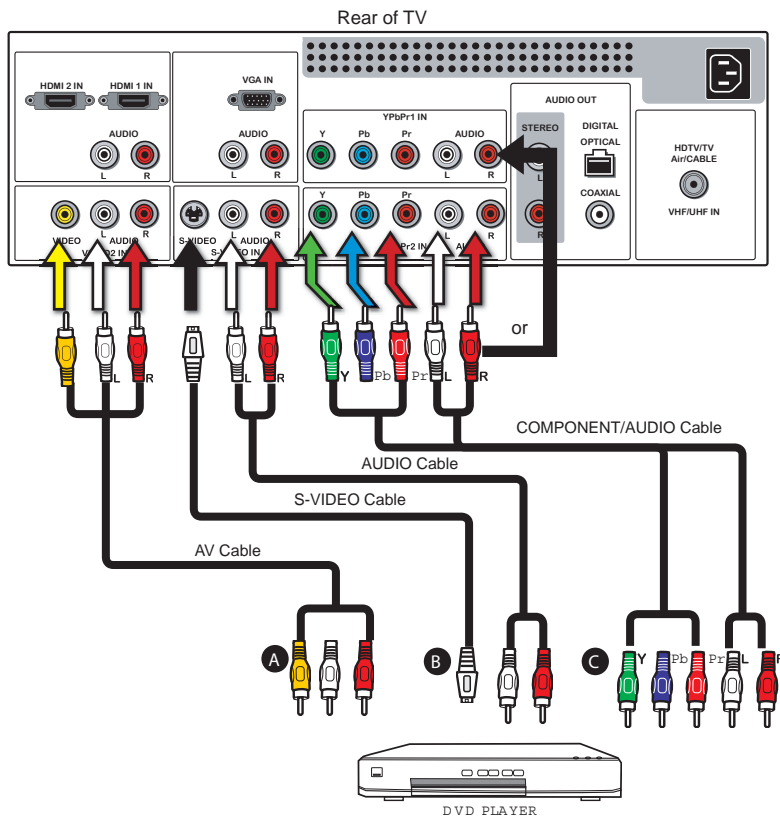

1

METHOD A:

Use a composite cable to connect the DVD player's composite video/audio jacks to the LCD TV's VIDEO2 IN jacks.

METHOD B:

Use an audio cable to connect the DVD player's audio output jacks to the LCD TV's audio inputs. Use an S-Video cable to connect the DVD player's s-video output jack to the LCD TV's S-VIDEO IN input jack.

METHOD C:

Use a component cable to connect the DVD player's component output jacks to the LCD TV's YPbPr1 IN or YPbPr2 IN input jacks.

Use an audio cable to connect the DVD player's component audio jacks to the LCD TV's audio input jacks.





The component video jacks on your DVD player are sometimes labeled YPbPr, or YCbCr. For an explanation of component video, see your DVD player's user guide.

- 2 Connect all AC power sources, before turning on the power switch of the LCD TV or other connected equipment.
- 3 Press the  button on the remote to turn on the LCD TV.
- 4 To watch a DVD, press the INPUT button on the remote to select VIDEO2(METHOD A), or VIDEO3 (METHOD B), or VIDEO4/VIDEO5 (METHOD C).

 For best picture quality, if your equipment has component video output, use a component cable instead of a composite video or S-video cable.

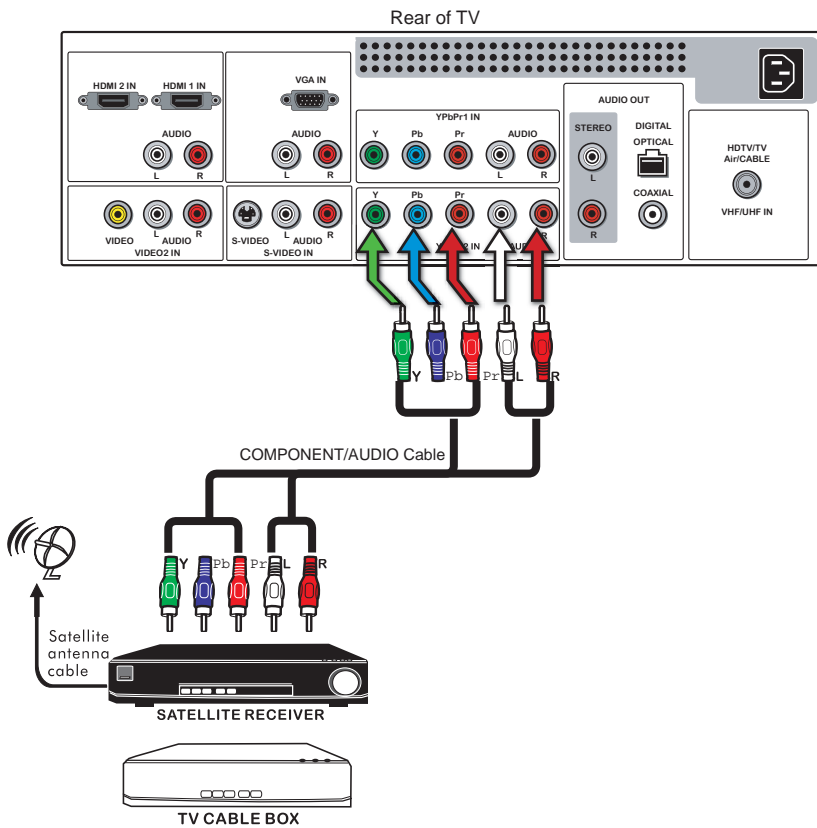
Connecting a Digital TV Cable Box or Digital Satellite Receiver



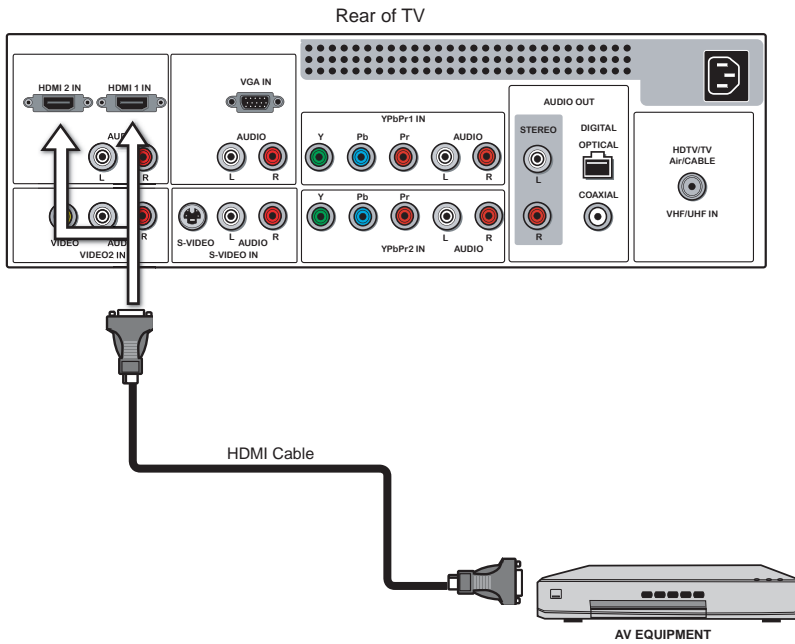

- 1 Use a component cable to connect the satellite receiver's/TV Cable Box's component (YPbPr1) output jacks to the LCD TV's component input jacks. Use an audio cable to connect the satellite receiver's/TV Cable Box's component audio jacks to the LCD TV's audio input jacks.
- 2 Connect all AC power sources, before turning on the power switch of the LCD TV or other connected equipment.
- 3 Press the  button on the remote to turn on the LCD TV.
- 4 To watch programs via satellite receiver or TV Cable Box, press the INPUT button on the remote to select VIDEO4/VIDEO5.

Connecting an AV Equipment with HDMI Connector





ENGLISH

- 1 Use a HDMI cable to connect the AV equipment's HDMI output jack to the LCD TV's HDMI IN jacks.
- 2 Connect all AC power sources, before turning on the power switch of the LCD TV or other connected equipment.
- 3 Press the  button on the remote to turn on the LCD TV.
- 4 Press the INPUT button on the remote to select VIDEO6 or VIDEO7.

 The HDMI connector provides both video and audio signals, it's not necessary to connect the audio cable.

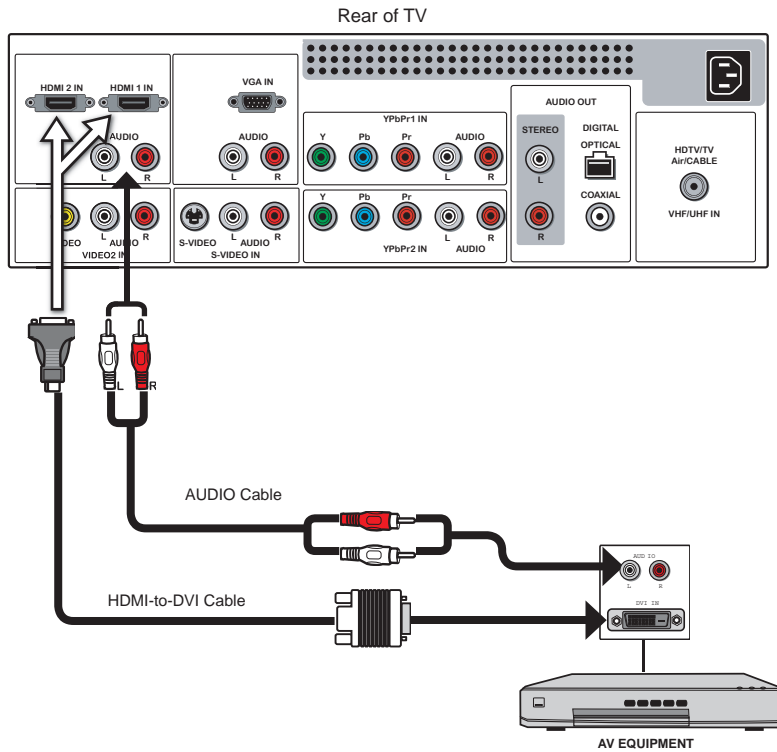
Connecting an AV Equipment with DVI Connector



- 1 Use a HDMI-to-DVI cable to connect the AV equipment's DVI output jack to the LCD TV's HDMI IN jacks.
Use an audio cable to connect the AV equipment's audio output jacks to LCD TV's HDMI AUDIO jacks.
- 2 Connect all AC power sources, before turning on the power switch of the LCD TV or other connected equipment.
- 3 Press the  button on the remote to turn on the LCD TV.
- 4 Press the INPUT button on the remote to select VIDEO6 or VIDEO7.

 If the LCD TV is connected to AV equipment's DVI connector, you will need an HDMI-to-DVI cable or an HDMI adapter(not supplied) and an audio cable.

Connecting a PC

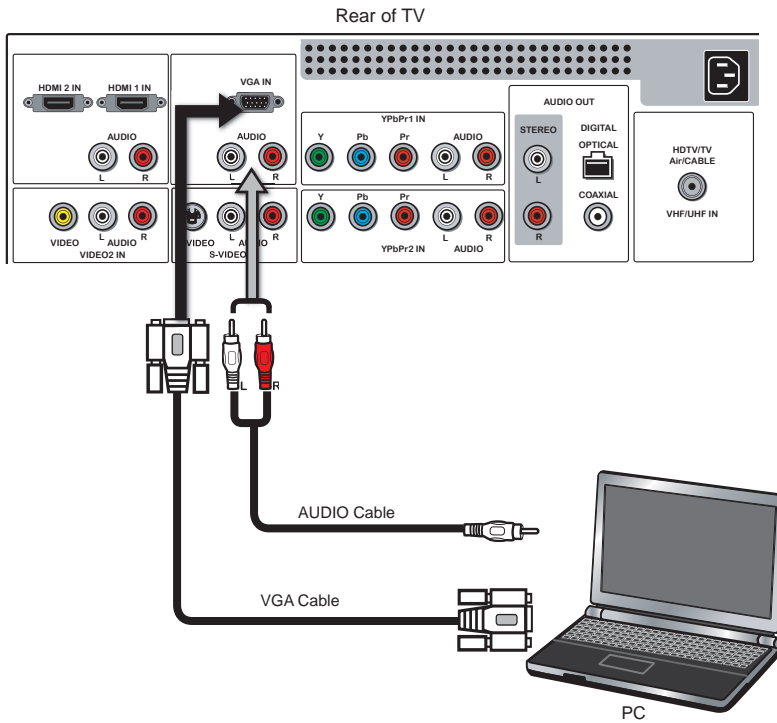

ENGLISH

- 1 Use a D-SUB cable to connect the PC's D-SUB output jack to the LCD TV's VGA input jack. Use an audio cable to connect the PC's audio output jacks to LCD TV's.
- 2 Connect all AC power sources, before turning on the power switch of the LCD TV or other connected equipment.
- 3 Press the  button on the remote to turn on the LCD TV.
- 4 Press the Input button on the remote to select COMPUTER.

Connecting an Audio Receiver or a Dolby Digital 5.1 Sound System

For better sound quality, you may want to use a Home Theater/Stereo System.

NOTE: If you have a Home Theater/Stereo System that you would like to use with your new TV, we recommend that you do NOT use your TV's audio output for this connection. For the best sound quality, our product testing has shown that you should connect your Home Theater/Stereo System directly to your A/V device. I.E. You should connect your Home Theater/Stereo System to your DVD player, Cable/Satellite box or other AV equipment. Although not recommended, if you prefer to use the TV audio output to make this connection to your Home Stereo System, please follow the instructions below.

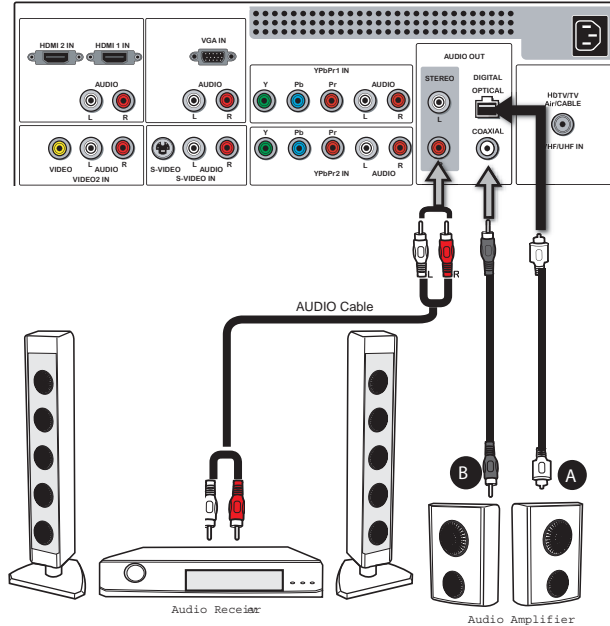

- 1** Connecting to Audio Receiver:
Use an audio cable to connect the audio receiver's audio LINE IN jacks to LCD TV's AUDIO OUT jacks.
- 2** Connecting to Digital 5.1 Sound System:
METHOD A:
Use a optical cable to connect the audio amplifier's OPTICAL IN jacks to LCD TV's OPTICAL OUT jacks.

METHOD B:
Use a coaxial cable to connect the audio amplifier's COAXIAL IN jacks to LCD TV's COAXIAL OUT jacks.
- 3** Connect all AC power sources, before turning on the power switch of the LCD TV or other connected equipment.
- 4** Press the  button on the remote to turn on the LCD TV.

Chapter 3

USING THE FEATURES

Wide Screen Viewing

Wide Screen function allows viewing of 4:3/16:9 images in wide screen mode, cycling through the following wide screen settings. Press the ASPECT button repeatedly to select the screen format you want.

1**FULL**

Stretches the image vertically and horizontally to keeps the image size consistent in the center of the screen and stretches the sides

**2****ZOOM**

Stretches the image vertically and horizontally to fill the screen at 1:2.35 aspect ratio

**3****WIDE**

Stretches the image vertically and horizontally to fill the screen at 1:1.85 aspect ratio



**4****NORMAL**

Displays at 4:3 aspect ratio



NORMAL is not available when you are watching 720p, or 1080i source.

Operating the Menu

- 1 Press the  button to turn the LCD TV on.
- 2 Press the MENU button on the remote control, the on-screen menu will appear on the screen. Use the   buttons to select your main menu option.

VIDEO MENU:

Allows you to make adjustments to your picture settings.

- If the signal source is TV/VIDEO/S-VIDEO/YPbPr/HDMI, the VIDEO MENU appears as:
- If the signal source is VGA, the VIDEO MENU appears as:

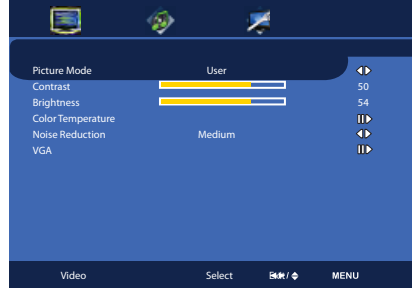

AUDIO MENU:

Allows you to customize the audio options and effects.

- If the signal source is VIDEO/S-VIDEO/YPbPr/HDMI/VGA, the AUDIO MENU appears as:
- If the signal source is TV, the AUDIO MENU appears as:

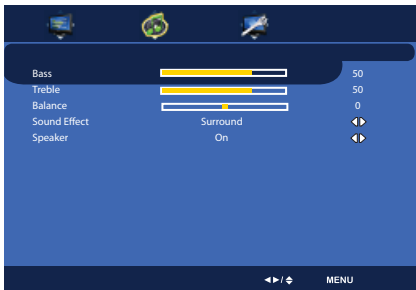

TV MENU:

Allows you to edit and label channels.

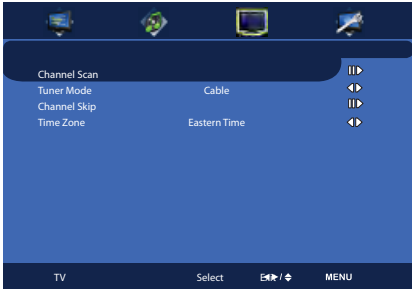

ENGLISH

SETUP MENU:

Allows you to set up a variety of features: Language, Closed Caption, Factory Reset, Parental Control, and Sleep Timer.

- If the signal source is TV/VIDEO/S-VIDEO/YPbPr, the SETUP MENU appears as:
- If the signal source is HDMI/VGA, the SETUP MENU appears as:

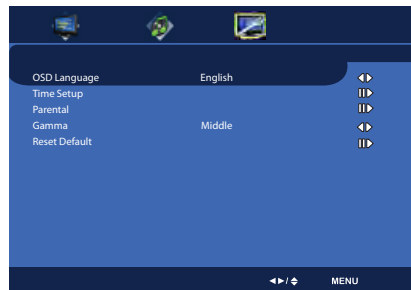
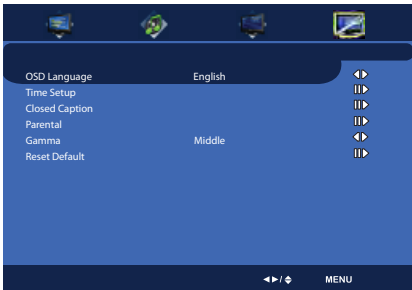

- Use the ▲ ▼ buttons to highlight the option of the sub-menu, and press the OK button. While in adjustment mode, and use the ◀ ▶ buttons to change the value of the item.
- Press the EXIT button to exit the menu.

Customizing the VIDEO Settings

- 1 Press the **⏻** button to turn the LCD TV on.
- 2 Press the MENU button on the remote control to display the Main menu, and use the **◀▶** buttons to select the VIDEO.
- 3 Use the **▲▼** buttons to highlight an individual VIDEO option, use the **◀▶** buttons to change the setting, and press the MENU to exit the menu

- If the signal source is TV/VIDEO/S-VIDEO/YPbPr/HDMI, the VIDEO MENU appears as:



- If the signal source is VGA, the VIDEO MENU appears as:

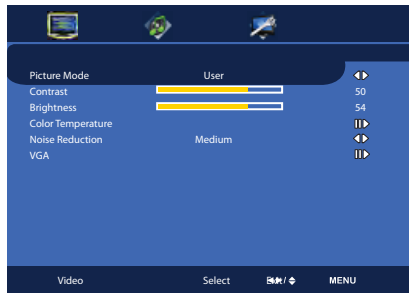

- 4 The VIDEO menu includes the following options:

Picture Mode	Cycles among display types: Vivid/Hi-Bright/Cinema/Sport/User
Contrast	Controls the difference between the brightest and darkest regions of the picture
Brightness	Controls the overall brightness of the picture
Saturation	Controls the color intensity
Hue	Controls the difference between the green and red regions of the picture
Sharpness	Increase this setting to see crisp edges in the picture; decrease it for soft edges

- Color temperature** Adjusts color components independently to achieve a warm or cool effect: Cool/Middle/Warm/User
- Warm: Increases red tint
 - Nature: Increases natural tint
 - Cool: Increases blue tint
 - User: Allows the user to adjust red, green and blue color component levels independently.

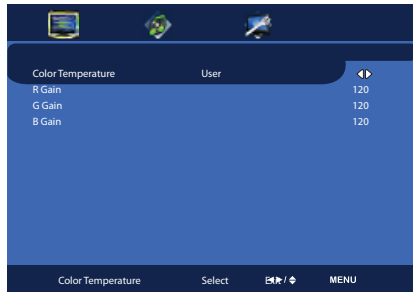

- Noise Reduction** Select to reduce the noise level of connected equipment: Medium/Strong/Off/Low.

- VGA** Press the **OK** button to enter the VGA Setting:

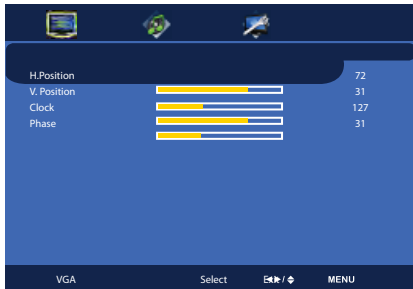

- H. Position Adjusts the position of the picture left and right in the window
- V. Position Adjusts the position of the picture up and down in the window
- Clock Controls the width of the picture based on the VGA mode
- Phase Controls the signal phase, which can improve focus clarity and image stability based on the VGA mode

Customizing the AUDIO Settings

- 1 Press the **⏻** button to turn the LCD TV on.
- 2 Press the MENU button on the remote control to display the Main menu, and use the **◀▶** buttons to select the AUDIO.
- 3 Use the **▲▼** buttons to highlight an individual AUDIO option, use the **◀▶** buttons to change the setting, and press the MENU to exit the menu

- If the signal source is VIDEO/S-VIDEO/YPbPr/HDMI/VGA, the AUDIO MENU appears as:



- If the signal source is TV, the AUDIO MENU appears as:



- 4 The AUDIO menu includes the following options:

Bass	Controls the relative intensity of lower-pitched sounds
Treble	Controls the relative intensity of higher pitched sounds
Balance	Adjusts the relative volume of the speakers in a multiple speaker system
Sound Effect	Allows selection of an audio-enhancement technique from among the following options: Surround/Live/Dance/Techno/Classic/Soft/Rock/POP/Off
MTS	Allows you to listen to high-fidelity stereo sound while watching TV <ul style="list-style-type: none"> ▪ Stereo: Use separate audio tracks for left and right speakers, if available ▪ SAP: You can enjoy a second audio program from the speakers while watching a scene in the original program ▪ Mono: Allows mono output (useful when stereo is noisy or inconsistent)

SPDIF Type	Allows to selection of the digital sound format: PCM/OFF/Dolby Digital <ul style="list-style-type: none">▪ PCM: The external audio system is connected to the AUDIO OUT (L/R) of the LCD TV▪ Dolby Digital: The external audio system is connected to the AUDIO OUT DIGITAL (OPTICAL or COAXIAL) of the LCD TV▪ OFF: Select OFF to turn off the external audio system
Audio Language	Allows to select the audio language:English/Spanish/French.
Speaker	Allows to select to turn on or off the TV speakers.

Customizing the TV Settings

- 1 Press the **⏻** button to turn the LCD TV on.
- 2 Press the MENU button on the remote control to display the Main menu, and use the **◀▶** buttons to select the TV.
- 3 Use the **▲▼** buttons to highlight an individual TV option, use the **◀▶** buttons changes the setting, and press the MENU exits the menu.

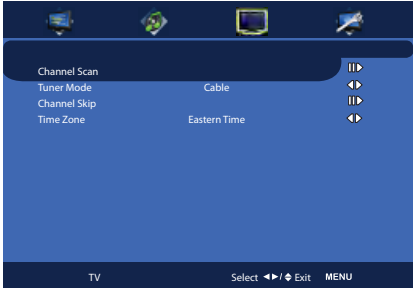

- 4 The TV menu includes the following options:

Channel Scan	Press the OK button, the Channel Scanning automatically creates a list of receivable channels.
Tuner Mode	Allows selection between CATV cable and antenna signal sources: <ul style="list-style-type: none"> ▪ AIR Choose this setting if you are receiving TV channels with an antenna (over the air) ▪ Cable Choose this setting if you are receiving TV channels with a CATV (cable TV)

Channel Skip Allows addition/removal of channels on the channel list.
 1 Press the OK button to display the Channel Skip menu:



- 2 Press the ▼ button to select the desired channel, and press the OK button repeatedly to select show (☑) or hide (☐)

F	Time Zone	Allows selection of regional TV systems of USA: Eastern Time/Indiana/Central time/Mountain Time/Arizona/ Pacific Time/Alaska/Hawaii
---	-----------	---

ENGLISH

Customizing the SETUP Settings

- 1 Press the ⏻ button to turn the LCD TV on.
- 2 Press the MENU button on the remote control to display the Main menu, and use the ◀▶ buttons to select the SETUP.
- 3 Use the ▲▼ buttons to highlight an individual SETUP option, use the ◀▶ buttons to change the setting, and press the MENU to exit the menu.

- If the signal source is TV/VIDOE/S-VIDEO/YPbPr, the SETUP MENU appears as:

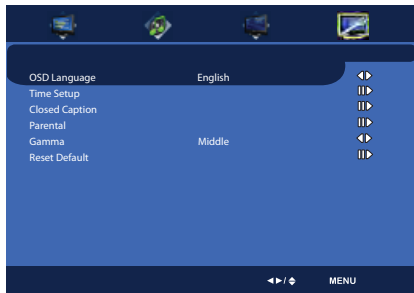

- If the signal source is HDMI/VGA, the SETUP MENU appears as:

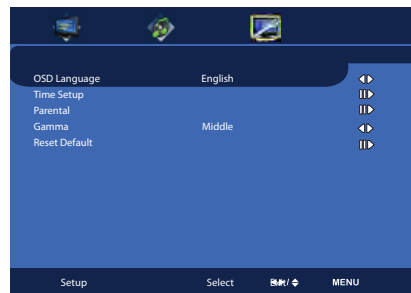

4

The SETUP menu includes the following options:

OSD Language	Selects to display all on-screen menus in your language of choice: English/French/Spanish
Time Setup	Allows to set the current time. <ul style="list-style-type: none"> ▪ ON :Selects to display the system current time. ▪ OFF :Selects to set the current time. <ol style="list-style-type: none"> 1 Press the ▲▼ buttons to select the Date or Time. 2 Press the ◀▶ buttons to move each setting, and use 0-9 keys to set the current time.



Closed Caption	Allows to select from analog or digital closed caption modes and press the OK button. The Closed Caption list appears: <ol style="list-style-type: none"> 1 Analog Closed Caption: <p>Press the ◀▶ buttons to select the basic analog closed caption options: OFF/CC1/CC2/CC3/CC4</p> <ul style="list-style-type: none"> ▪ CC1 /CC2 /CC3 /CC4: Display a printed version of the dialog and sound effects of the program being viewed ▪ T1/T2: Display station information presented using either half or the whole screen ▪ T3/T4: Extended Data Services. For example: Network name, program name, program length, etc.
----------------	---

2 Digital Closed Caption:

Press the ◀▶ buttons to select the digital closed caption options:
Service1/Service2/Service3/Service4/Service5/Service6/OFF

Note: The setting here will be applied to each DTV channel

3 Caption Style:

Press **OK** button to customize the settings for digital closed caption option:

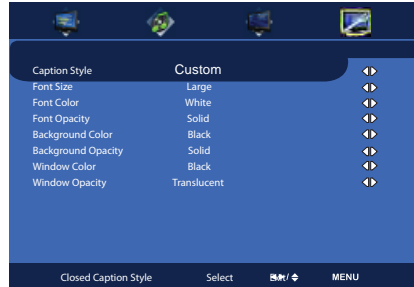
**Parental**

The Parental Control can be set up to the TV to block Channel, Video Source and to change password.

- 1** Use the ▼ button to select the Parental, and press the OK to display the Parental menu
- 2** Use the Program Block function, must enter a four-digit password. The factory password is 0000
- 3**
 - Program Block Allows to setup the TV and MPAA Rating Lock options (refer to "Using the Program Block Setting").



- **Channel Block** Allows to block digital channels.



- **Input Block** Selects to block a Input source signal



- **Change Password** Selects to change your password

Gamma Allows adjustment of the display's gamma correction, which fine tunes both brightness and red/green/blue ratios: Bright/Middle/Dark.

Reset Default Press the OK button to restore factory settings

Using the Program Block Settings

ENGLISH

- 1 Press the MENU button on the remote control to display the Main menu, and use the ◀▶ buttons to select the SETUP.

- 2 Use the ▼ buttons to highlight **Parental**, and press the OK button.

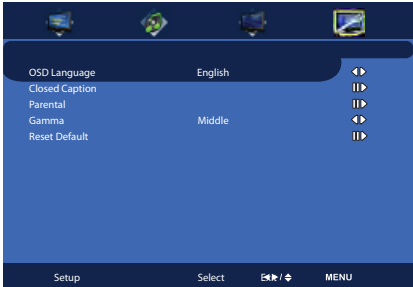

- 3 Use the Parental function, must enter a four-digit password. The factory password is 0000.

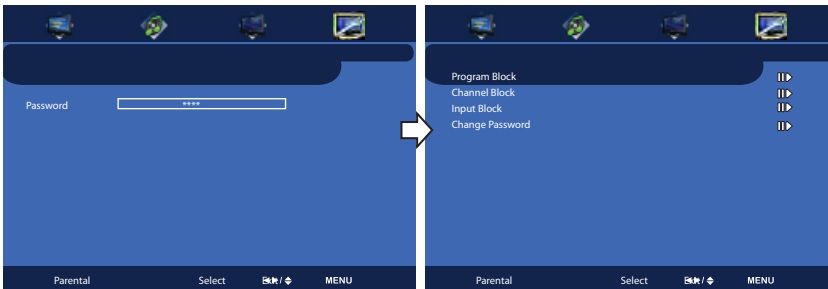

- 4 Use the ▼ button to select the Program Block, and press the OK to display the Program Block menu.



5

The Parental block menu includes the following options:

U.S. TV Ratings	Selects to activate the TV Rating programs.
U.S. Movie Ratings	Selects to activate the MPAA Rating programs
Canadian English Ratings	Selects to activate the English Rating programs of Canada.
Canadian French Ratings	Selects to activate the French Rating programs of Canada
Block MPAA Unrated	<ul style="list-style-type: none">▪ YES: Block all movies that are broadcast without a MPAA rating.▪ NO: Allows all movies that are broadcast without a MPAA rating
Block TV None Rating	<ul style="list-style-type: none">▪ YES: Block all movies that are broadcast without a TV rating.▪ NO: Allows all movies that are broadcast without a TV rating.

U.S. TV Ratings

The U.S.TV Rating has 2 rating methods: Content-Based Rating and Age-Based Rating. The U.S.TV Rating includes the following options:



ENGLISH

AGE-BASED

RATING	DESCRIPTION
TV-Y	All children
TV-Y7	Directed to children age 7 and older
TV-G	General Audience
TV-PG	Parental Guidance suggested
TV-14	Parents strongly cautioned
TV-MA	Mature Audience only

CONTENT-BASED

RATING	DESCRIPTION
FV	Fantasy violence
D	Suggestive dialogue
L	Strong language
S	Sexual situations
V	Violence
ALL	All contents are blocked

		CONTENT-BASED				
		FV	D	L	S	V
AGE-BASED	TV-Y					
	TV-Y7	✓				
	TV-G					
	TV-PG		✓	✓	✓	✓
	TV-14		✓	✓	✓	✓
	TV-MA			✓	✓	✓

✓ : To block programs by both content and age.

Use the ◀▶▲▼ buttons to select the rating you want and press the OK button repeatedly to select BLOCK UNBLOCK . □

Canadian English Ratings

The Canadian English Ratings includes the following options:

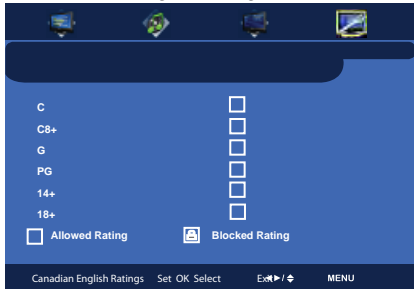

RATING	DESCRIPTION
C	All children
C8+	Children 8 years and older
G	General programming
PG	Parental guidance
14+	Viewers 14 and older
18-	Adult programming

Use the ◀▶▲▼ buttons to select the rating you want and press the OK button repeatedly to select BLOCK UNBLOCK .

Canadian French Ratings

The Canadian English Ratings includes the following options:

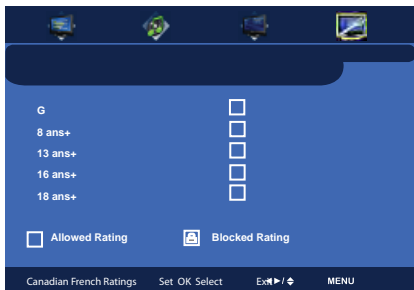

RATING	DESCRIPTION
G	General programming
8 ans+	Not recommended for ages under 8
13 ans+	Not recommended for ages under 13
16 ans+	Not recommended for ages under 16
18 ans+	Programming restricted to adults.



Use the ◀▶▲▼ buttons to select the rating you want and press the OK button repeatedly to select BLOCK UNBLOCK .

U.S. Movie Ratings

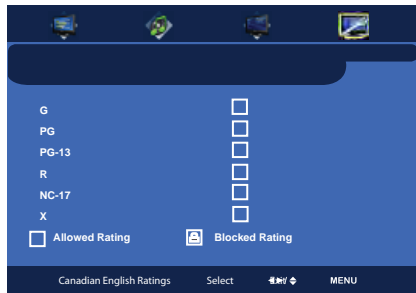
The U.S. Movie Ratings is used for original movies rated by the Motion Picture Association of America (MPAA) as broadcasted on cable TV and not edited for television. The U.S. Movie Ratings includes the following options:



RATING	DESCRIPTION
G	General Audiences. Movie is appropriate for all ages
PG	Parental Guidance Suggested. May contain material not suited for younger viewers
PG-13	Contains content that may not be appropriate for viewers under the age of 13
R	Restricted. Contains adult content, no one under 17 admitted without parent
NC-17	No one 17 and under admitted
X	No one 17 and under admitted

Use the ◀▶▲▼ buttons to select the rating you want and press the OK button repeatedly to select BLOCK  UNBLOCK .

ENGLISH

Using the Program Guide

The Program Guide feature brings all sorts of information to your screen, such as program title, program duration, time remaining, rating information, closed caption, availability, etc.

- 1 With the LCD TV connected to a television programming source, press the INPUT button on the remote control and use the ▲▼ buttons to select TV and press the OK button.
- 2 Press the GUIDE button on the remote control, the Program Guide will appear on the screen:

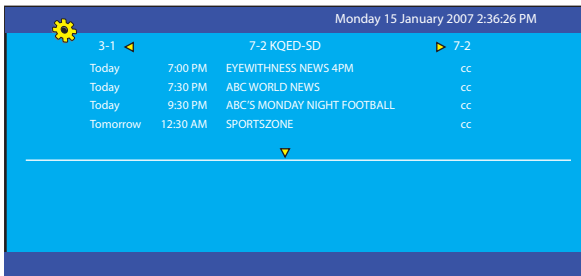

- 3 Press the ◀▶ button to select the channel.
- 4 Press the ▲▼ button to select the program from a list, the Program Guide provides introduction about the current program being shown on each channel. The Program information in the guide is provided by the broadcasters. It may sometimes include only the channel number, without a program title or description.

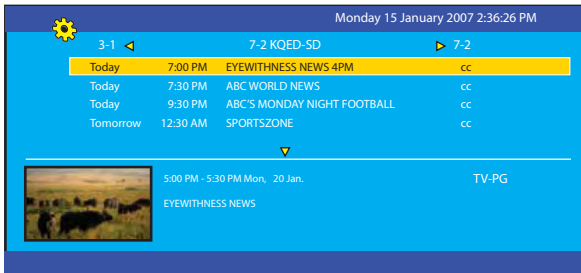

- 5 Press the GUIDE button again on the remote control to exit the Program Guide

SPECIFICATIONS

ENGLISH

LCD Panel	Panel Size	40" TFT LCD
	Brightness	500 cd/m ²
	Contrast Ratio	1200:1
Max. Resolution		1366x768
Input Connector	VIDEO/AUDIO(L/R)	2
	S-VIDEO/AUDIO(L/R)	1
	YPbPr/AUDIO(L/R)	2
	VGA/AUDIO(L/R)	1
	HDMI/AUDIO(L/R)	2
	AUDIO OUT(L/R)	1
	OPTICAL/COAXIAL	1
	HEADPHONE	1
Power Source		AC100~240V, 50/60HZ, 3.0A
Power Consumption		300 W, standby < 5 W
Dimension		38.9 w x 29.3 h x 9.4 d inch
WEIGHT		69 LB

PROGRAMMING YOUR REMOTE CONTROL

Your remote lets you control four devices with one easy-to-use, compact unit. After installing batteries, you can program the remote to control your Universal TV, VCR or DVD, Cable or Satellite Receivers, Amplifier or Tuner, and Auxiliary devices. To do so, follow the instructions in "Programming a Device". For best results, please read and follow all the remaining instructions. Keep this guide for future reference.

A Quick Look at Programming a Device

To control VCR or DVD, Cable or Satellite Receivers, Amplifier or Tuner, and Auxiliary devices, follow these steps. Before proceeding, find the codes for the devices you want to program in "Manufacturer's Codes" on the right side of this page and write them down or highlight them.



To program a DVD Player, TV/DVD Combo, TV/VCR/DVD Combo, portable DVD player, or mobile DVD player, use the DVD key.

1

Turn on the device (for example, DVD player) and, if needed, load media (for example, a DVD).

2

Press a device key (VCR/DVD, CBL/ SAT, or AUX).

3

Press and hold **SET UP** until the red LED blinks twice; then release.

4

Enter the first five-digit code for your device. The LED blinks once as each digit is entered. If the code is correct, the LED blinks twice.



If the LED does not blink twice, repeat steps 2 to 4 and try entering the code again.

5

Aim the remote at the device and press . The device should turn off. If it does not, repeat steps 3–5, trying each code for your brand until you find one that works. If you cannot find a code that works, see "Searching for Your Code".

6

Repeat steps 1–5 for the other devices you want to control. For future reference, write down each working device code below:

AUX Code:

CBL Code:

CD Code:

DVD Code:

SAT Code:

TNR Code:

VCR Code:

7

Press set to save and exit.

Searching for your Code

If your device does not respond to the remote after trying all codes listed for your brand, or if your brand is not listed, try searching for your code:

- 1 Press a device key once.
- 2 Press and hold **SET UP** until the red LED blinks twice; then release.
- 3 Enter **9-9-1**, then the device group number (0= Cable, 1= TV, 2= VCR, 3= Audio). The LED blinks twice.
- 4 Aim the remote at the device and press . The remote sends IR codes from its library to the selected device, starting with the most popular code first. If the device responds, go to step 7.
- 5 If the device does not respond, press **CH▲**. The remote will try the next code. Continue until the device responds. Press **CH▼** to try the previous code.
- 6 To search for other device codes, repeat steps 1 to 5.
- 7 Press **SET UP** to save and exit.

Checking the Codes

If you have set up the remote using the procedure in "Searching for Your Code", you may need to find out which four-digit code is operating your equipment.

For example, to find out which code is assigned to your TV:

- 1 Press **TV** once.
- 2 Press and hold **SET UP** until the red LED blinks twice; then release.
- 3 Enter **9-9-0**. The LED blinks twice.
- 4 To view the code for the first digit, press 1. Count the LED blinks (for example, three blinks = 3), and write down the number in the appropriate code listing in step 8 under "Programming a Device".

 If a code digit is 0, the LED does not blink.
- 5 Repeat step 4 for the four remaining digits, using 2 for the second digit, 3 for the third digit, 4 for the fourth digit, and 5 for the fifth digit.

Changing Volume Lock

The remote comes preset to allow independent volume control of each selected device (Global Volume Unlock). However, you may change the Volume Lock setting to Global Volume Lock so that one device's volume will control volume in all other modes. After that, you can perform Individual Volume Unlock on a selected device to set its volume control for independent operation or Global Volume Unlock to remove all volume locking.

Changing Volume Lock

The remote comes preset to allow independent volume control of each selected device (Global Volume Unlock). However, you may change the Volume Lock setting to Global Volume Lock so that one device's volume will control volume in all other modes. After that, you can perform Individual Volume Unlock on a selected device to set its volume control for independent operation or Global Volume Unlock to remove all volume locking.

Locking Volume Control to One Mode (Global Volume Lock)

- 1 Press and hold **SET UP** until the red LED blinks twice; then release.
- 2 Enter **9-9-3** and then press the mode key for the device you want to control volume (for example, TV). The LED blinks twice. Now when you press VOL+, VOL-, or Mute, the selected device (for example, TV) will control the volume regardless of the current mode.

Unlocking All Volume Control (Restoring Global Unlock)

- 1 Press and hold **SET UP** until the red LED blinks twice; then release.
- 2 Enter **9-9-3** and then press VOL+. The LED blinks four times. Volume is now independently controlled for all programmed devices.

Unlocking a Single Device's Volume Control

- 1 Press a device key (TV, VCR/DVD, CBL/ SAT, or AUX).
- 2 Press and hold **SET UP** until the red LED blinks twice; then release.
- 3 Enter 9-9-3 and then press VOL-. The LED blinks four times. Volume is now independently controlled for the selected devices.

Troubleshooting

PROBLEM	SOLUTION
LED does not blink when you press a key.	<ul style="list-style-type: none"> ▪ Replace battery with new AAA size battery.
LED blinks when you press a key, but device does not respond.	<ul style="list-style-type: none"> ▪ Make sure the remote is aimed at your device and is not more than 15 feet away
LED blinks one long blink.	<ul style="list-style-type: none"> ▪ An entry error has occurred (for example, wrong key). Try entry sequence again.
Remote does not control devices or commands are not working properly.	<ul style="list-style-type: none"> ▪ Try all listed codes for the device. Make sure the device operates with an infrared remote control.
CH▲, CH▼, and LAST do not work for your RCA TV.	<ul style="list-style-type: none"> ▪ Due to RCA design from 1983 to 1987, only the original remote control will operate these functions.
No volume on a device.	<ul style="list-style-type: none"> ▪ See "Changing Volume Lock".
Channels do not change properly.	<ul style="list-style-type: none"> ▪ If the original remote control required you to press Enter to change channels, press Enter on this remote after entering the channel number.

Manufacturer's setup codes/setup codes

Audio Amplifiers

Manufacturer	Code	Manufacturer	Code
Adcom	0577, 1100	Modulaire	0395
Aiwa	0406	NEC	0264
Arcam	0269	Naim	0269
Bose	0674	Nakamichi	0321
Carver	0892, 0269	Optimus	0013, 0300, 0823, 0395
Cinema Sound	0160	Panasonic	0308, 0521
Curtis Mathes	0300	Pass Labs	0269
Denon	0160	Philips	0892, 0269
Durabrand	1561	Pioneer	0013, 0300, 0823
Elan	0647	Polk Audio	0892, 0269
GE	0078	RCA	0013, 0300, 0823
Grundig	0269	RadioShack	0395
Harman/Kardon	0892	Realistic	0013, 0395, 0220
JVC	331	Revox	0269
Left Coast	0892	Sansui	0321
Lennox	1561	Shure	0264
Linn	0269	Sony	0815, 0220, 0689
Luxman	0165	Soundesign	0078
Magnavox	0269	Technics	0308, 0521
Marantz	0892, 0269, 0321	Victor	0331
McIntosh	0251	Wards	0013, 0078
Micromega	0269	Yamaha	0354, 0133

Cable Converters

Manufacturer	Code	Manufacturer	Code
A-Mark	0008, 0144	Nova Vision	0008
ABC	0237, 0003, 0008	Novaplex	0008
Accuphase	0003	Pace	0877, 1877, 0237, 0008
Acorn	0237	Panasonic	0000, 0008, 0144, 0107
Action	0237	Paragon	0000, 0008, 0525
Active	0237	Penneys	0000
Americast	0899	Philips	1305, 0317
Archer	0237	Pioneer	0877, 1877, 0144, 0533
BCC	0276	Pulsar	0000
Bell South	0899	Quasar	0000
British Telecom	0003	Regal	0276, 0279
Century	0008	Runco	0000
Digeo	1187	Samsung	0003, 0144
Director	0476	Scientific Atlanta	0877, 1877, 0477, 0237, 0003, 0000, 0008
Fosgate	0276	Son	1006
GE	0144	Sprucer	0144
General Instrument	0476, 0810, 0276, 0003	Starcom	0003
Gibraltar	0003	Supercable	0276
GoldStar	0144	Time Warner cable	1877
Hamlin	0009	Torx	0003
Hitachi	0003, 0008, 0009	Toshiba	0000
Insight	0476, 0810	US Electronics	0276, 0003, 0008
Jerrold	0476, 0810, 0276, 0003	United Cable	0276, 0003
Memorex	0000	Videoway	0000
Mitsubishi	0003	Zenith	0000, 0008, 0525, 0899
Motorola	0476, 1376, 0810, 0276, 1187		

Audio Amp/Tuners

Manufacturer	Code	Manufacturer	Code
ADC	0531	Kenwood	1313, 1570, 1569, 0186, 0042, 0239, 0027, 0077
AMC	1077	Koss	1497, 1366, 0424
AMW	1563, 1615	LG	1293
Aiwa	1243, 1405, 1388, 1641, 0189, 0121, 0405, 0158	LXI	0181
Akai	1255, 1512, 0244, 0346	Lasonic	1798
Alco	1390	Lennox	1437
Amphion Media Works	1563, 1615	Lexicon	1076
Anam	1609, 1074	Linn	0189
Apex	1257	Liquid Video	1497
Apex Digital	1774, 1257, 1430	Lloyd's	0195
Arcam	1189, 1120	Lloyds	0195
Audiotronic	1189	MCS	0039, 0346
Audiovox	1390, 1627	Magnavox	1189, 1269, 0531, 1266, 0189, 1514, 0195, 0391, 1120
B & K	0820, 0840, 0701, 0702	Marantz	1189, 1269, 0891, 0189, 1289, 1120, 0039
BK	0702	McIntosh	289
Bose	1229, 0639, 1253	Micromega	1189, 0189
Brix	1602	Mitsubishi	1393
Cairn	0189	Modulaire	0195
Cambridge Soundworks	1370	Myryad	1189
Capetronic	0531, 0195	NAD	0320
Carver	1189, 0189, 0121, 1289, 0042, 0360, 0008	Nakamichi	1313, 0097, 1555, 0347
Casio	0195	New Castle	0502
Clarinette	0195	Nikko	0322
Classic	1352	Nikkodo	0322
Coby	1389	Norcent	1389
Compaq	1136	Nova	1389
Criterion	1420	Onkyo	0842, 0135, 1320, 1298, 1531
Curtis Mathes	0014, 0080, 0039	Optimus	1023, 0531, 0014, 1074, 0670, 0121, 0186, 0080, 0195, 0738, 0801, 0042, 0181, 0502, 0219, 0158, 0074, 0163, 0177
Daewoo	1250	Oritron	1497, 1366
Dell	1383	Outlaw Audio	0391
Delphi	1414	Panasonic	1308, 1518, 1548, 1288, 1316, 1763, 1764, 1633, 0309, 0367, 0039
Denon	1142, 1360, 1306, 0121, 0004	Penney	0195
Emerson	0531, 0195, 0424	Penneys	0195, 0039
Fisher	1801, 0801, 0042, 0360, 0219, 0008	Philips	1189, 1269, 0891, 1266, 0189, 0391, 1120
Garrard	0463, 0424	Pioneer	1023, 1384, 0531, 0014, 0150, 0630, 0080, 0801, 0244, 0346
Gateway	1517, 1567	Polaroid	1508
Go Video	1352, 1532	Polk Audio	0189, 1289, 1414
Grundig	0189	Proscan	1254, 0054
Harman/Kardon	0110, 1304, 1306, 0891, 0189, 1289	Quasar	0039
Hewlett Packard	1181	RCA	1023, 1609, 1254, 0531, 1511, 1390, 1074, 0080
Hitachi	1273, 1801		
Initial	1426		
Inkel	0491		
Integra	0842, 0135, 1320, 1298		
JBL	0110, 1306		
JVC	1058, 1374, 1495, 1811, 0074		
KLH	1428, 1390, 1412		
Kawasaki	1390		

Audio Amp/Tuners

Manufacturer	Code	Manufacturer	Code
RadioShack	1609, 0181	Sony	1058, 1441, 1258, 1759, 1758, 1622, 1858, 1658, 1558, 1406, 0405, 0474, 1349, 1442, 0158
Realistic	1609, 0121, 0186, 0195, 0042, 0181, 0158, 0163, 0177	Soundesign	0670
Regent	1437	Stereophonics	1023
Revox	0189	Sunfire	1313
Rio	1869, 1383	Teac	1267, 1390, 1074, 1528, 0463, 0163
Rio Audio	1383	Technics	1308, 1518, 1633, 0309, 0039
Saba	1519	Thorens	1189
Samsung	1295, 1500	Toshiba	0842, 0135, 0080
Sansui	1189, 0189, 0346	Venturer	1390
Sanyo	1801, 1469, 1251, 0801, 0360, 0219	Victor	0074
Scott	0322, 0163	Waitec	1352
Sears	0195, 0424	Wards	0014, 0189, 0080, 0042, 0054, 0158
Sharp	0186, 1286	XM	1406, 1414
Sharper Image	1556	Yamaha	1023, 0176, 1176, 1375, 1331, 1276, 0186
Sherwood	1077, 1653, 0491, 0502, 1423	Yorx	0195
Shinsonic	1426	Zenith	1293, 0857, 0346
Siemens	0424		
Sirius	1811, 1602, 1627		
Sonic Blue	1869, 1532, 1383		

ENGLISH

Miscellaneous Audio

Manufacturer	Code	Manufacturer	Code
Altec Lansing	1485	Marantz	1491
Cambridge Soundworks	1530	Motorola	1464
Creative	0872	Netgear	1785
D-Link	1522	Omnifi	1605
Imerge	1491	Onkyo	1789
Integra	1789	SSI	1522
Jerrold	0520	Yamaha	1809, 1810

Satellite Receivers

Manufacturer	Code	Manufacturer	Code
AlphaStar	0772	GE	0566, 0392
Bell ExpressVu	0775	GOI	0775, 1775
Chaparral	0216	General Instrument	0869
DirecTV	0566, 0639, 1639, 1640, 0247, 0749, 1749, 1142, 1442, 0724, 0819, 1856, 1108, 1609, 0392, 1392, 1076, 0099	Goodmans	1246
Dish Network	0775	HTS	0775, 1775
Dish Network System	0775, 1775, 1005, 1505	Hitachi	1250, 0749, 0819
Dishpro	0775, 1775, 1005, 1505	Houston tracker	0775
EchoStar	0775, 1775, 1005, 1505	Hughes	0749, 1749, 1142, 1442
Expressvu	0775, 1775	Hughes Network Systems	0749, 1749, 1142, 1442
		Innova	0099
		JVC	0775, 1775
		Jerrold	0869
		LG	1226

Manufacturer	Code	Manufacturer	Code
Magnavox	0724, 0722	RCA	0566, 1142, 1442, 0775,
McIntosh	0869		0143, 0855, 0392, 1392
Memorex	0724	RadioShack	0566, 0775, 0869
Mitsubishi	0749	SKY	0856, 0099
Motorola	0869, 0856	Samsung	1142, 1442, 1276, 1108,
NEC	1270		1609
Netsat	0099	Sanyo	1219
Next Level	0869	Sony	0639, 1639, 1640
Optimus	0724	Star Choice	0869
Panasonic	0701, 0247	Star Trak	0772, 0869
Paysat	0724	Thomson	0566, 0392
Philips	0749, 1749, 1142, 1442,	Tivo	1142, 1442
	0775, 0724, 0722, 0819,	Toshiba	0749, 1749, 0790, 1285,
	1076, 0099		0819
Pioneer	1142, 1442	UltimateTV	1640, 1392
PrimeStar	0869	Uniden	0724, 0722
Proscan	0566, 0392	Voom	0869
		Zenith	0856, 1856

TVs

Manufacturer	Code	Manufacturer	Code
A-Mark	0047, 0054	Bell & Howell	0054, 0154, 0093
AOC	0180, 0030	Bell and Howell	0054, 0154, 0093
Accuscan	0047	BenQ	1756, 1032
Action	0030	Bradford	0180
Admiral	0463, 0180, 0047,0054,	Brockwood	0030, 0178
	0017, 0051, 0093	Broksonic	0236, 0463, 0180
Advent	0761, 0783, 0815,0817,	CXC	0180
	0842	Candle	0030
Adventuri	0000	Capehart	0017, 0030, 0178, 0092
Agna	0150	Capetronic	0030
Aiko	0092	Carnivale	0030
Akai	0060, 0702,0672, 0030,	Carver	0054
	0145, 0812	Celebrity	0000
Albatron	0700, 0843	Celera	0765
Alfi de	0672	Changhong	0156,0765, 0783, 0767
Alleron	0030	Cineral	0451, 0092
Ambassador	0150	Citek	0047
America Action	0180	Citizen	0054, 0000, 0451, 0463,
American High	0000, 0060		0180,0060, 0030, 0092,
Amstrad	0171		0171
Amtron	0000, 0180	Clarion	0180
Anam	0180	Classic	0030, 0092
Apex	0156, 0748, 0765	Colortyme	0047, 0054, 0017, 0060,
Apex Digital	0156, 0748, 0765,0879,		0030, 0178
	0767	Commercial Solutions	0047, 1447
Audinac	0180	Conic	0178
Audiovox	0451, 0180, 0092, 0623	Contec	0180
Aumark	0060	Craig	0180, 0171
Aventura	0171	Crosley	0054, 0000, 0180, 0030,
Baysonic	0180		0171
Beaumarck	0017, 0030, 0178	Crown	0093, 0180, 0672
Belcor	0030	Crown Mustang	0672

Manufacturer	Code	Manufacturer	Code
Curtis Mathes	0047, 0054, 0154, 0000, 0051, 0451, 0093, 0180, 0060, 0702, 0030, 0178, 0145, 0166, 1147, 1347	American High	0000, 0060
Daewoo	0451, 1661, 0672, 0178, 0092, 0623, 1755, 1756, 0661	Amstrad	0171
Dayton	0092	Amtron	0000, 0180
Daytron	0030, 0178, 0092	Anam	0180
Dell	1454	Apex	0156, 0748, 0765
Denon	0511, 0145	Apex Digital	0156, 0748, 0765, 0879, 0767
Dumont	0017, 0180, 0178	Audinac	0180
Durabrand	0463, 0180, 0178, 0171, 1034, 1463	Audiovox	0451, 0180, 0092, 0623
Dwin	0093	Aumark	0060
ESA	0171, 0812	Aventura	0171
Eaton	0060	Baysonic	0180
Electroband	0000	Beaumarck	0017, 0030, 0178
Electrograph	1755	Belcor	0030
Electrohome	0154, 0000, 0150, 0030, 0178	Bell & Howell	0054, 0154, 0093
Emerald	0178	Bell and Howell	0054, 0154, 0093
Emerson	0047, 0154, 0451, 0236, 0463, 0180, 0150, 0178, 0171, 0623	BenQ	1756, 1032
Envision	0030	Bradford	0180
Fisher	0054, 0154, 0000	Brockwood	0030, 0178
Fortress	0093	Broksonic	0236, 0463, 0180
Funai	0000, 0180, 0171	CXC	0180
Futuretech	0180	Candle	0030
GE	0047, 0000, 0051, 0451, 0060, 0030, 0178, 1147, 1347, 1447	Capelight	0017, 0030, 0178, 0092
Gateway	1755, 1756	Capetronic	0030
Gemini	0047	Carnivale	0030
Gibraltar	0017, 0000, 0030	Carver	0054
Gibraltar	0017, 0030Go	Celebrity	0000
A-Mark	0047, 0054	Celera	0765
AOC	0180, 0030	Changhong	0156, 0765, 0783, 0767
Accuscan	0047	Cineral	0451, 0092
Action	0030	Citek	0047
Admiral	0463, 0180, 0047, 0054, 0017, 0051, 0093	Citizen	0054, 0000, 0451, 0463, 0180, 0060, 0030, 0092, 0171
Advent	0761, 0783, 0815, 0817, 0842	Clarion	0180
Adventuri	0000	Classic	0030, 0092
Agna	0150	Colortyme	0047, 0054, 0017, 0060, 0030, 0178
Aiko	0092	Commercial Solutions	0047, 1447
Akai	0060, 0702, 0672, 0030, 0145, 0812	Conic	0178
Albatron	0700, 0843	Contec	0180
Alfi de	0672	Craig	0180, 0171
Alleron	0030	Crosley	0054, 0000, 0180, 0030, 0171
Ambassador	0150	Crown	0093, 0180, 0672
America Action	0180	Crown Mustang	0672
		Curtis Mathes	0047, 0054, 0154, 0000, 0051, 0451, 0093, 0180, 0060, 0702, 0030, 0178, 0145, 0166, 1147, 1347
		Daewoo	0451, 1661, 0672, 0178, 0092, 0623, 1755, 1756, 0661
		Dayton	0092
		Daytron	0030, 0178, 0092

Manufacturer	Code	Manufacturer	Code
Dell	1454	Monivision	0700, 0843
Denon	0511, 0145	Motorola	0054, 0051, 0093, 0150
Dumont	0017, 0180, 0178	Multitech	0180
Durabrand	0463, 0180, 0178, 0171, 1034, 1463	NAD	0156, 0178, 0166, 1156, 0866
Dwin	0093	NEC	0047, 0030, 0178, 1704
ESA	0171, 0812	NTC	0092
Eaton	0060	NetTV	1755
Electroband	0000	Nikko	0047, 0017, 0154, 0156, 0030, 0178, 0092, 1347
Electrograph	1755	Nikkodo	0030, 0178, 0092
Electrohome	0154, 0000, 0150, 0030, 0178	Nishi	0030
Emerald	0178	Norcent	0748
Emerson	0047, 0154, 0451, 0236, 0463, 0180, 0150, 0178, 0171, 0623	Nyon	0000
Envision	0030	Onwa	0180
Fisher	0054, 0154, 0000	Optimus	0154, 0250, 0093, 0180, 0150, 0030, 0178, 0166, 0650, 0679
Fortress	0093	Optonica	0093
Funai	0000, 0180, 0171	Orion	0017, 0236, 0463, 0180, 0178, 1463
Futuretech	0180	PCE	0156, 0060
GE	0047, 0000, 0051, 0451, 0060, 0030, 0178, 1147, 1347, 1447	Pace	0092
Gateway	1755, 1756	Panasonic	0047, 0054, 0154, 0000, 0156, 0051, 0250, 0093, 0236, 0150, 0060, 0053, 0030, 0178, 0145, 1347, 0650
Gemini	0047	Panda	0706
Gibraltar	0017, 0000, 0030	Paxonic	0060, 0030
Gibraltar	0017, 0030Go	Penney	0047, 0156, 0051, 0060, 0030, 0178, 1347
Video	0060	Penneys	0047, 0000, 0156, 0051, 0250, 0060, 0030, 0178
GoldStar	0047, 0054, 0030, 0178	Petters	1523
Goodmans	0360	Philco	0054, 0463, 0030, 0145
Gradiente	0053	Philips	1454, 0054, 0017, 0000, 0030, 0171, 1254, 0690
Logik	0236, 0180	Pilot	0051, 0060, 0030, 0178
MGA	0150, 0030, 0178	Pioneer	0166, 0866, 0679
MGN Technology	0178	Polaroid	0765, 0865, 1523
MTC	0180, 0060, 0030, 0092	Portland	0451, 0092
Magnasonic	0054, 0000, 0156, 0093, 0030, 0092	Precision	0236, 0180
Magnavox	0047, 1454, 0054, 0154, 0000, 0051, 0250, 0180, 0060, 0030, 0092, 0171, 0706, 1254, 1755	Prima	0761, 0783, 0815, 0817
Majestic	0017	Princeton	0700
Marantz	1454, 0054, 0030	Prism	0051, 0250
Matsushita	0051, 0250, 0650	Proscan	0047, 0030, 1347, 1447
Maxcent	1755, 1756	Proton	0178
Maxent	1755	Pulsar	0017, 0092
Megapower	0700	Pulser	0178, 0092
Megatron	0047, 0178, 0145	Quartz	0150, 0178
Memorex	0154, 0463, 0180, 0150, 0060, 0030, 0178	Quasar	0051, 0250, 0650
Micro Genius	0150		
Midland	0047, 0017, 0051		
Mitsubishi	0154, 0093, 0150, 1250, 0030, 0178, 0836		

Manufacturer	Code	Manufacturer	Code
RCA	0090, 1547, 0047, 0054, 0000, 0051, 0093, 0178, 1047, 1147, 1247, 1347, 1447, 0679	TMK	0236, 0180, 0178
Rabbit	0047	TNCi	0017
RadioShack	0047, 0154, 0180, 0150, 0030, 0178	TNS	0463
Realistic	0047, 0154, 0180, 0150, 0030, 0178	Tandy	0093
Runco	0017, 0060, 0030	Tatung	0000, 0051, 1756
SR2000	0154, 0171	Teac	0154, 0706
SSS	0180	Technics	0047, 0054, 0017, 0051, 0250, 1347, 0650
SV2000	0054	Technovox	0030
SVA	0748, 0865	Techwood	0051, 0250, 0060
Sampo	0047, 0030, 1755, 1756	Teknika	0054, 0463, 0180, 0150, 0060, 0178, 0092
Samsung	0047, 0054, 0017, 0154, 0060, 0702, 0030, 0178, 1060, 0812	Telecolor	0017
Sanky	0060, 0030	Telefunken	0702
Sansui	0463, 0060, 0030	Thomas	0047, 0178
Sanyo	0088, 0047, 0054, 0154, 0000, 0463, 0171, 1755	Thomson	0047, 1447
Saville	0060	Tocom	0156
Scotch	0178	Toshiba	0154, 0156, 0150, 1265, 0060, 0145, 0166, 1145, 1156, 1256, 1356, 1656, 1704, 0650
Scott	0236, 0180, 0030, 0178	Totevision	0051
Sears	0047, 0054, 0017, 0154, 0000, 0156, 0051, 0093, 0060, 0053, 0030, 0178, 0171, 0166	Toyomenka	0178
Sharp	0054, 0093, 0180	Truetone	0051, 0250
Sheng Chia	0093	Ultra	0092
Shivaki	0178	Universal	0047
Siemens	0145	V	1755, 1756
Signature	0054	Vector Research	0030
Signature 2000	0047, 0093, 0030	Victor	1100, 0053
Simpson	0030, 0178	Vidikron	0054
Singer	0060, 0092	Vidtech	0178
Solar Drape	0000	Viewsonic	1755
Sony	1100, 0017, 0154, 0000, 0150, 0053	Viking	0060
Soundesign	0180, 178	Visio	1755, 1756
Spectravision	0156, 0178	Vizio	1756
Squareview	0171	Wards	0047, 0054, 0017, 0154, 0000, 0156, 0051, 0093, 0236, 0180, 0060, 0030, 0178, 0166, 1147, 1347, 1156, 0866
Starlite	0236, 0180	Waycon	0156
Studio Experience	0843	Welton	0178
Supreme	0000	Westinghouse	0451
Sylvania	0047, 0054, 0154, 0000, 0051, 0030, 0178, 0092, 0171	White Westinghouse	0451, 0236, 0463, 0623
Symphonic	0000, 0180, 0178, 0171	World	0451, 0236, 0463, 0180
		XR1000	0154, 0180, 0171
		Yamaha	0030
		Yorx	0030
		Zenith	0047, 0017, 0000, 0093, 0463, 0030, 0178, 0145, 0092, 0171, 1145, 0812

VCRs

Manufacturer	Code	Manufacturer	Code
A-Mark	0000, 0037, 0240	Emerald	0184, 0121
ABS	1972	Emerex	0032
Admiral	0209, 0060, 0048, 0039, 0047, 0104	Emerson	1479, 1278, 0000, 0037, 0184, 0240, 0121, 0043, 0209
Adventura	0000, 0037, 0240	Fisher	0000, 0039, 0047, 0104
Adyson	0072	Fuji	0035, 0033
Aiwa	0124, 0000, 0037	Fujitsu	0000
Akai	0175, 0041	Funai	0000, 0037, 0072
Alba	0209, 0072	GE	1035, 1060, 0807, 0000, 0035, 0060, 0048, 0240
Alienware	1972	Garrard	0000
Allegro	0039	Gateway	1972
American High	0035, 0081	Gemini	0060
Amstrad	0000	Genexxa	0000, 0037
Asha	0240	Go Video	0614, 0240
Astra	0035, 0240	GoldStar	1237, 0000, 0035, 0037, 0039
Audiovox	0037	Granada	0081, 0042
Avis	0000, 0072	Grundig	0081
Beaumarck	0240	HI-Q	0000, 0035, 0047
Bell & Howell	0000, 0035, 0048, 0039, 0104	HP	1972
Bell and Howell	0000, 0035, 0048, 0039, 0104	Harley Davidson	0000
Broksonic	1479, 0184, 0121, 0209	Harman/Kardon	0081
CCE	0072	Harvard	0072
Calix	0037	Harwood	0072
Candle	0037	Hewlett Packard	1972
Canon	0035	Hitachi	0089, 0000, 0035, 0037, 0045, 0042, 0041
Carrera	0240	Howard Computers	1972
Carver	0035, 0081	Hughes Network Systems	0739, 0042
Citizen	1278, 0000, 0035, 0037, 0240, 0209	Humax	0739
Classic	0037	Hush	1972
Colortyme	0035, 0060, 0045	Hytek	0000, 0047, 0072
Colt	0000, 0072	TT Nokia	0240, 0041
Craig	0037, 0047, 0240, 0072	JVC	0067, 0041
Criterion	0000, 0072	Janeil	0240
Crosley	0000, 0035, 0081	Jensen	0067, 0041
Crown	0072	KEC	0037
Curtis Mathes	1035, 0000, 0035, 0060, 0162, 0240, 0041	KLH	0072
CyberPower	1972	KTV	0000
Cybernex	0240	Kenwood	0067, 0041
Daewoo	1278, 0037, 0045	Kodak	0035, 0037
Daytron	0037	LG	0037, 0240
Dell	1972	LXI	0000, 0037, 0042, 0067
Denon	0081, 0042	Linksys	1972
Derwant	0041	Lloyd's	0000
DirectTV	0739	Lloyds	0000, 0240, 0072
Dual	003, 0000	Loewe	0081
Dynatech	0000, 0240	Logik	0000, 0240, 0072
Electrohome	0000, 0060, 0037, 0240, 0043, 0209	M Electronic	0240
Electrohome	0043, 0209	MEI	0035
Electrohome	0037	MGA	0060, 0240, 0043

Manufacturer	Code	Manufacturer	Code
MGN Technology	0240	Metz	0037
MTC	0000, 0240, 0072	Microsoft	1972
MTC	0000, 0240, 0072	Midland	0240
MTX	0000	Mind	1972
Magnasonic	1278, 0000, 0037, 0240, 0072	Minolta	0042
Granada	0081, 0042	Mitsubishi	0807, 0000, 0060, 0048, 0047, 0042, 0067, 0043, 0041
Grundig	0081	Motorola	0035, 0048
HI-Q	0000, 0035, 0047	Movie Walker	0072
HP	1972	Multitech	0000, 0039, 0072
Harley Davidson	0000	NAD	0240, 0104
Harman/Kardon	0081	NAP	0035, 0037, 0039, 0033, 0042
Harvard	0072	NEC	0067, 0104, 0041
Harwood	0072	Newtech	0072
Hewlett Packard	1972	Nikko	0037
Hitachi	0089, 0000, 0035, 0037, 0045, 0042, 0041	Nikkodo	0037
Howard Computers	1972	Nishi	0240
Hughes Network Systems	0739, 0042	Niveus Media	1972
Humax	0739	Noblex	0240
Hush	1972	Northgate	1972
HYTEK	0000, 0047, 0072	Olympus	0035, 0162, 0104
KEEC	0037	Onkyo	0222
KLH	0072	Optimus	0000, 0035, 0037, 1062, 0048, 0047, 0162, 0240,
KTV	0000	Orion	1479, 0000, 0184, 0240, 0104, 0121, 0209
Kenwood	0067, 0041	Panama	0035
Kodak	0035, 0037	Panasonic	0225, 1035, 0000, 0614, 0616, 0035, 1062, 0162
LG	0037, 0240	Penney	1237, 1035, 0035, 0037, 0042, 0240
LXI	0000, 0037, 0042, 0067	Penneys	0000, 0035, 0037, 0047, 0081, 0162, 0042, 0067, 0240
Linksys	1972	Pentax	0042
Lloyd's	0000	Philco	0000, 0035, 0081, 0209
Lloyds	0000, 0240, 0072	Philips	0000, 0616, 0618, 0739, 0035, 0048, 0081, 0162, 0045, 0209
Loewe	0081	Pilot	0037
Logik	0000, 0240, 0072	Pioneer	0081, 0162, 0042, 0067
M Electronic	0240	Polk Audio	0081
MEI	0035	Profi tronic	0240
MGA	0060, 0240, 0043	Proscan	1060, 0060
MGN Technology	0240	Protec	0000, 0072
MTC	0000, 0240, 0072	Protech	0072
MTC	0000, 0240, 0072	Pulsar	0039, 0240
MTX	0000	Pulser	0240
Magnasonic	1278, 0000, 0037, 0240, 0072	Quartz	0035, 0047
Magnavox	1781, 0000, 0618, 0035, 0037, 0048, 0039, 081, 0240	Quasar	1035, 0035, 0162
Magnin	0035, 008, 0240	RCA	1035, 1060, 0807, 0000, 0880, 0035, 0060, 0048, 0045, 0042, 0240
Marant1 Marta	0037		
Matsui	0037, 0209		
Matsushita	0035, 0081, 0162		
Media Center PC	1972		
Memorex	1237, 0000, 0035, 0037, 0048, 0039, 0047, 0162, 0240, 0104, 0209, 0072		

Manufacturer	Code	Manufacturer	Code
RadioShack	0000, 0035, 0037, 0048, 0047, 0162, 0240, 0104	Symphonic	0000, 0240
Radix	0037	Systemax	1972
Randex	0037	TMK	0000, 0240
Realistic	0000, 0035, 0037, 0048, 0047, 0162, 0240, 0104, 0121	TNIX	0037
ReplayTV	0614, 0616	Tagar Systems	1972
Ricavision	1972	Tandy	0000, 0104
Runco	0039	Tatung	0000, 0048, 0081, 0067, 0041
STS	0042	Teac	0000, 0067, 0041
SV2000	0000, 0072	Technics	0000, 0035, 0060, 0037, 0039, 0162
SVA	0000	Teknika	0000, 0035, 0037
TT Nokia	0240, 0041	Telecorder	0240
JVC	0067, 0041	Telefunken	0041
Janeil	0240	Thomas	0000
Jensen	0067, 0041	Thomson	0060, 0041
Samsung	0000, 1014, 0739, 0060, 0045, 0240	Tivo	0618, 0636, 0739, 1503
Samtron	0240	Tocom	0240
Sanky	0048, 0039	Toshiba	0845, 1145, 0000, 1503, 1008, 1972, 0045, 0240, 0043, 0209, 0041
Sansui	1479, 0000, 0067, 0240, 0209, 0041, 0072	Totevision	0037, 0240
Sanyo	0159, 0000, 0047, 0240, 0104	Touch	1972
Scott	0184, 0045, 0121, 0043	Trix	0037
Sears	1237, 0000, 0035, 0060, 0037, 0048, 0039, 0047, 0033, 0162, 0045, 0042, 0067, 0104, 0043, 0209, 0041, 0072	Ultra	0045
Sharp	0807, 0000, 0048, 0047, 0032	Unitech	0240
Shintom	0000, 0039, 0240, 0072	Vector	0045
Shogun	0240	Vector Research	0184
Siemens	0037, 0104	Vextra	0072
Signature	0035	Victor	0067, 0041
Signature 2000	0000, 0035, 0060, 0037, 0048	Video Concepts	0045
Singer	0037, 0240, 0072	Videomagic	0037
Sonic Blue	0614, 0616	Videosonic	0000, 0240, 0072
Sony	1232, 0000, 0636, 1972, 0035, 0047, 0032, 0033, 0067	Viewsonic	1972
Soundmaster	0000	Villain	0000
Stack 9	1972	Voodoo	1972
Sylvania	1781, 0000, 0035, 0081, 0043	Wards	0000, 0035, 0060, 0037, 0048, 0039, 0047, 0081, 0033, 0045, 0042, 0240, 0043, 0041, 0072
		White Westinghouse	000, 0209, 0072
		World	0209
		XR-1000	0000, 0035, 0072
		XR1000	0000, 0035, 0240, 0072
		Yamaha	0041
		ZT Group	1972
		Zenith	1479, 0000, 0037, 0039, 0033, 0209, 0041

DVD Players

Manufacturer	Code	Manufacturer	Code
3D LAB	0503, 0539	Firstline	0651
Advent	1016	Fisher	0670
Aiwa	0641	Funai	0675, 1268, 1334
Akai	0899, 0770, 0705	GE	0522, 0717, 0815
Alba	0672, 0717	GPX	0699
Alco	0790	Gateway	1158, 1073
Allegro	0869	General Electric	0717
Apex	0533, 0672, 1056, 1061, 0830, 0794, 0796, 0797, 1100, 1020, 0717, 0755	Go Video	0573, 1075, 1044, 0744, 0717, 0869, 0741, 0783, 1158, 1099, 1304, 1730, 0833, 0715
Apex Digital	0672, 1056, 1061, 0830, 0794, 0796, 0797, 1100, 1004, 1020, 0717, 0755	Go Vision	1071
Aspire Digital	1168	GoldStar	0801, 0869, 0741
Audiovox	0790, 0717, 1071, 1121, 1122	Goodmans	0790
Axion	1071	Gradiente	0490, 0651
Blaupunkt	0717	Greenhill	0717
Blue Parade	0571	Grundig	0539, 0705
Blue Sky	0695, 0699	Harman/Kardon	0582, 0702
Brandt	0651	Hitachi	0573, 0664, 1247
Broksonic	0695, 0868	Hiteker	0672
California Audio Labs	0490	IRT	0783
Celestial	1020	Initial	0717
Centrex	0672, 1004	Integra	0571, 0627
CineVision	0869, 0876, 0833	JBL	0702
Cinea	0831	JMB	0695
Citizen	1003, 1277	JVC	0623, 1164, 0558, 0867
Clairtone	0571	Jensen	1016
Coby	0778, 1107	KLH	1020, 0790, 0717, 1149
Craig	0831	KLH Digital	0717
Creative	0503, 0539	Kawasaki	0790
Curtis Mathes	1087	Kenwood	0490, 0534
CyberHome	0816, 1023, 1117, 1024, 1129, 0874	Kloss	0533
Cytron	0705	Koss	1061, 0651
DVD2000	0521	LG	0801, 0591, 0869, 0741
Daewoo	0869, 1172, 0784, 0770, 1169, 0705, 0833	Lasonic	0798, 0627
Dansai	0770	Lecson	1533
Decca	0770	Lennox	1127
Denon	0490, 0634	Lite-On	1058, 1158
Denver	0778	LiteOn	1058, 1158, 1416, 1440
DiViDo	0705	Loewe	0511, 0741
Digitrex	0672	Logix	0783
Disney	0675, 1270	Magnasonic	0675, 0651
Dual	0675	Magnavox	0503, 0539, 0675, 0646, 0821
Durabrand	1127	Marantz	0503, 0539, 0675
Electrohome	1003	McIntosh	1533
Emerson	0675, 0821, 1268, 0591	Medion	0651
Enterprise	0591	Memorex	0695, 1270, 0831
Entivo	0503, 0539	Microsoft	0522
Enzer	0770	Minato	0752
		Mintek	0717, 0839
		Mitsubishi	0521, 1521
		NAD	0591, 0741

Manufacturer	Code	Manufacturer	Code
NEC	0785, 0869	Sansui	0695
Naiko	0770	Sanyo	0695, 0675, 0670, 1334, 0873
Nesa	0717	Schneider	0783
NexxTech	1402	Schwaiger	0752
Norcent	1003, 1107	Sensory Science	1158
Onkyo	0792, 0503, 0627	Sharp	0675, 1256, 0752, 0630
Optimus	0571	Sharper Image	1117
Orion	0695	Sherwood	0770, 1043
Oritron	0651	Shinsonic	0533, 0839
Paisonic	0672	Slim Art	0784
Panasonic	0503, 0490, 1762, 0703, 1362, 1462, 1490, 0571	Sonic Blue	0573, 0869, 0783, 1099, 0715
Philips	0503, 0539, 0675, 1267, 0646, 0854, 1354, 1260	Sony	0533, 1033, 1431, 0864, 1533
Phonotrend	0699	Sova	1122
PianoDisc	1024	Superscan	0821
Pioneer	0571, 0525, 0631	Sylvania	0675, 0821, 1268, 0630
Polaroid	1061, 1020	Symphonic	0675, 0821, 1268, 1334
Polk Audio	0539	Tatung	0770
Portland	0770	Teac	0809, 0571, 0790, 0717
Prima	1016	Technics	0490, 0703
ProVision	0778	Technika	0770
Proceed	0672	Tevion	0651
Proscan	0522	Theta Digital	0571
Prosonic	0699	Thomson	0511, 0522
Qwestar	0651	Toshiba	0503, 0695, 1045, 1154, 0573, 0539
RCA	0522, 0571, 0822, 1132, 1022, 0790, 0717	US Logic	0839
RadioShack	0571	USLogic	0839
Radionette	0741	Unimax	0770
Realistic	0571	Universum	0591
Reoc	0752	Urban Concepts	0503, 0539
Revoy	0699	Venturer	0790
Rio	0869	Wesder	0699
Rotel	0623	Xbox	0522
Rowa	1004, 0823	Yamaha	0490, 0539, 0545
SVA	0717	Zenith	0503, 0591, 0869, 0741
Saba	0651	Zeus	0784
Sampo	0752	iLo	1348
Samsung	0490, 0573, 0820, 1075, 0899, 1044, 0744		

CARE

- Keep the remote dry. If it gets wet, wipe it dry immediately.
- Use and store the unit only in normal temperature environments.
- Handle the remote gently and carefully. Don't drop it.
- Wipe the remote with a damp cloth to keep it looking like new.

20070301